

IGBT or MOSFET: Choose Wisely

by Carl Blake and Chris Bull, International Rectifier

With the proliferation of choices between MOSFETs and IGBTs, it is becoming increasingly difficult for today's designer to select the best device for their application. Here are a few basic guidelines that will help this decision-making process.

Device Evolution: Bipolar Transistors, MOSFETs and IGBTs

The bipolar transistor was the only “real” power transistor until the MOSFET came along in the 1970's. The bipolar transistor requires a high base current to turn on, has relatively slow turn-off characteristics (known as current tail), and is liable for thermal runaway due to a negative temperature co-efficient. In addition, the lowest attainable on-state voltage or conduction loss is governed by the collector-emitter saturation voltage $V_{CE(SAT)}$.

The MOSFET, however, is a device that is voltage- and not current-controlled. MOSFETs have a positive temperature co-efficient, stopping thermal runaway. The on-state-resistance has no theoretical limit, hence on-state losses can be far lower. The MOSFET also has a body-drain diode, which is particularly useful in dealing with limited free wheeling currents.

All these advantages and the comparative elimination of the current tail soon meant that the MOSFET became the device of choice for power switch designs.

Then in the 1980s the IGBT came along. The IGBT is a cross between the bipolar and MOSFET transistors (see figure 1).

The IGBT has the output switching and conduction characteristics of a bipolar transistor but is voltage-controlled like a MOSFET. In general, this means it has the advantages of high-current handling capability of a bipolar with the ease of control of a MOSFET. However, the IGBT still has the disadvantages of a comparatively large current tail and no body drain diode.

Early versions of the IGBT are also prone to latch up, but nowadays, this is pretty well eliminated. Another potential problem with some IGBT types is the negative temperature co-efficient, which could lead to thermal runaway and makes the paralleling of devices hard to effectively achieve. This problem is now being addressed in the latest generations of IGBTs that are based on “non-punch through” (NPT) technology. This technology has the same basic IGBT structure (see Figure 1) but is based on bulk-diffused silicon, rather than the epitaxial material that both IGBTs and MOSFETs have historically used.

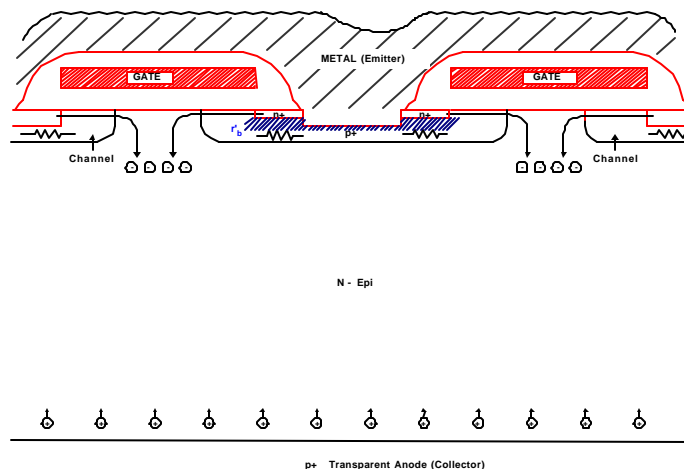

Figure 1. NPT IGBT cross section

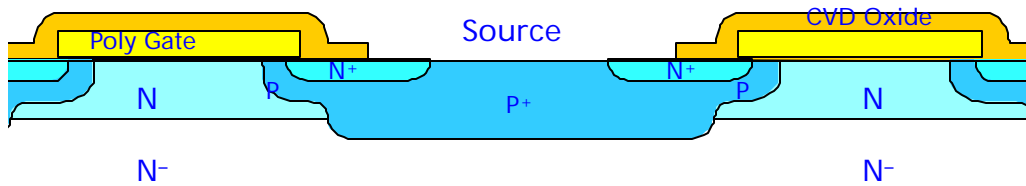

Figure 2. Typical MOSFET cross section

MOSFETs and IGBTs: Similar But Different

When comparing Figures one and two, the MOSFET and IGBT structures look very similar. The basic difference is the addition of a p substrate beneath the n substrate. The IGBT technology is certainly the device of choice for breakdown voltages above 1000V, while the MOSFET is certainly the device of choice for device breakdown voltages below 250V.

Between 250 to 1000V, there are many technical papers available from manufacturers of these devices, some preferring MOSFETs, some IGBTs. However, choosing between IGBTs and MOSFETs is very application-specific and cost, size, speed and thermal requirements should all be considered.

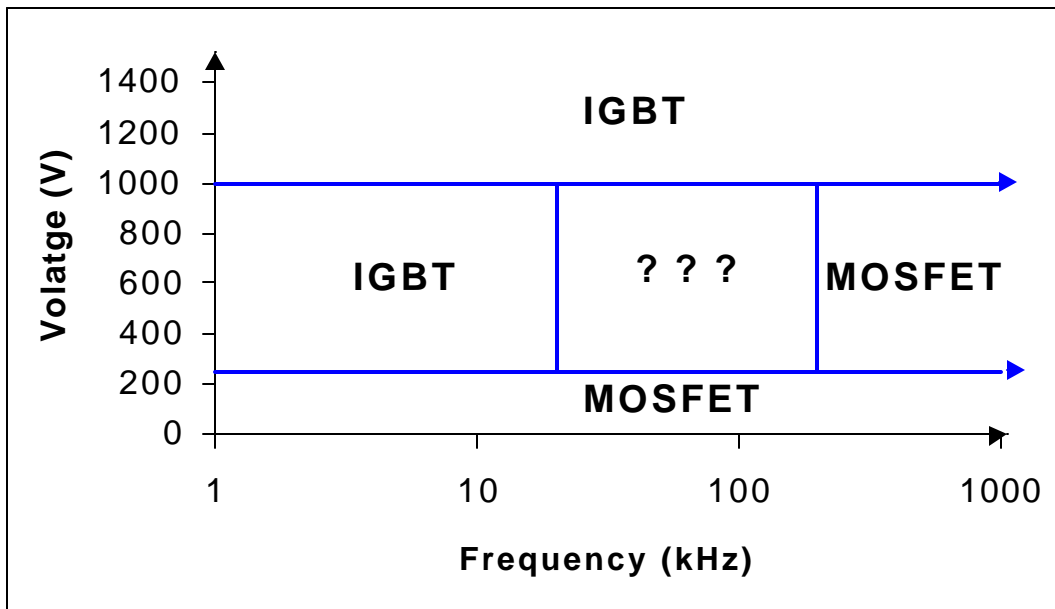

Figure 3. Where MOSFETs and IGBTs are preferred, not counting output power.

Figure 3 shows some of the boundaries where it is fairly clear as to what is preferred, the MOSFET or IGBT, the specifics are further detailed below. As a general guideline, this is good starting point.

IGBTs have been the preferred device under these conditions:

- Low duty cycle
- Low frequency (<20kHz)
- Narrow or small line or load variations
- High-voltage applications (>1000V)

- Operation at high junction temperature is allowed ($>100^{\circ}\text{C}$)
- $>5\text{kW}$ output power

Typical IGBT applications include:

- Motor control: Frequency $<20\text{kHz}$, short circuit/in-rush limit protection
- Uninterruptible power supply (UPS): Constant load, typically low frequency
- Welding: High average current, low frequency ($<50\text{kHz}$), ZVS circuitry
- Low-power lighting: Low frequency ($<100\text{kHz}$)

MOSFETs are preferred in:

- High frequency applications ($>200\text{kHz}$)
- Wide line or load variations
- Long duty cycles
- Low-voltage applications ($<250\text{V}$)
- $< 500\text{W}$ output power

Typical MOSFET applications include:

- Switch mode power supplies (SMPS): Hard switching above 200kHz
- Switch mode power supplies (SMPS): ZVS below 1000 watts
- Battery charging

Theory Versus Reality – And the ‘Grey Area’

Of course, nothing is as easy as it seems. Trade-offs and overlaps occur in many applications. The purpose of this article is to examine the cross-over area that includes applications operating above 250 volts , switching between 10 kHz and 200kHz at power levels above 500 watts . In this case, final device selection is based on other factors such as thermal impedance, circuit topology, conduction performance, and packaging. The zero-voltage switched (ZVS) power factor correction (PFC) circuit in Figure 3 is an application that falls into the IGBT/MOSFET “cross-over area.”

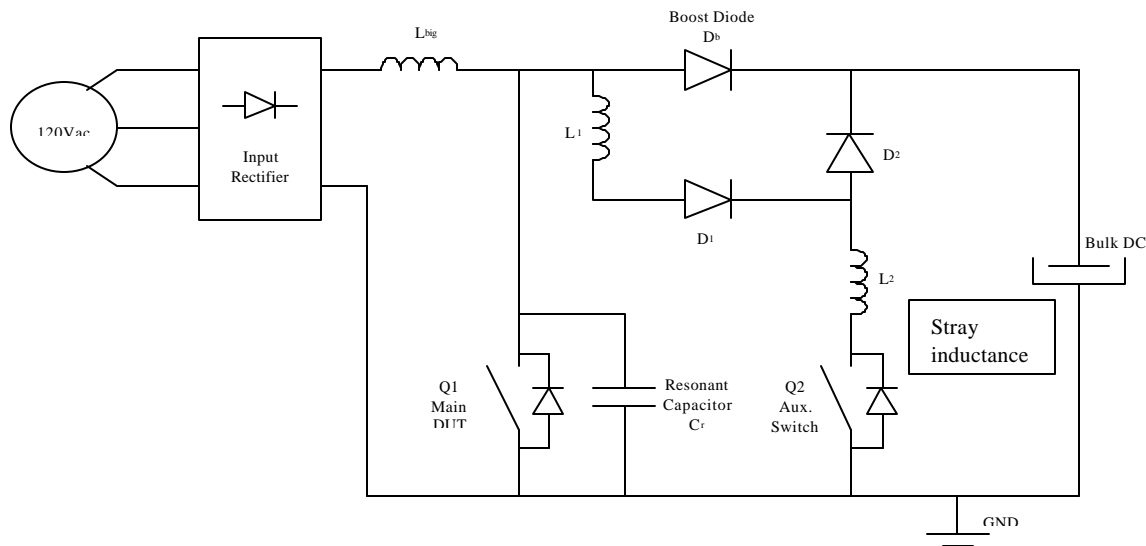

Figure 4. A typical ZVS PFC circuit. The auxiliary switch at Q2 is used to reset the boost diode to ensure that main switch Q1 is only switched during zero-voltage periods. The diode in parallel with Q1 is used with IGBTs only.

The hard-switched measurements clearly show the lower losses of the MOSFET in their applications. Chart 1 shows that the losses of the IGBT are approximately equal to the losses of an IRFP460 if the switching speed is reduced to 50 kHz. This could allow a smaller IGBT to replace the larger MOSFET in some applications. This was the condition in 1997.

However, the newer lower charge MOSFETs now available lower the losses at high frequency and therefore re-asserted the dominance of MOSFETs in applications using hard switching above 50kHz.

**Chart 1 - Hard Switched PFC @ 50kHz & 100kHz
 , 300W**

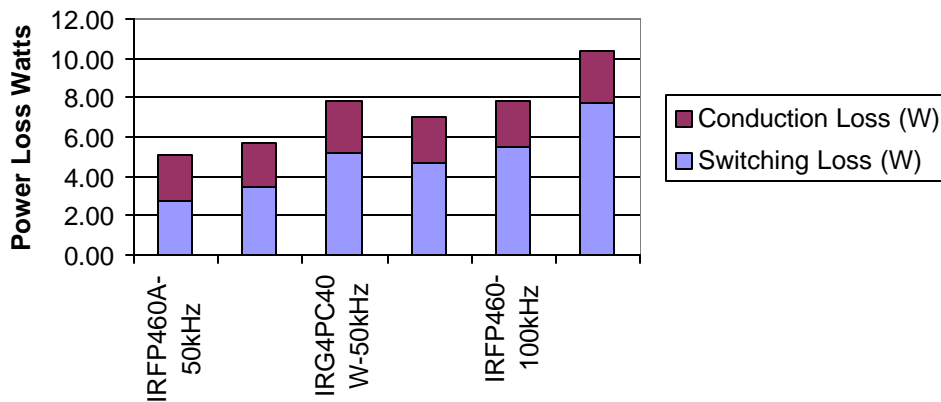

Chart 2 shows the losses in an application using Zero Voltage Switching at 50kHz, 500W, the IGBT losses of 9.5W are higher than the MOSFET losses of 7W at room temperature. When the temperature is raised up to operating conditions however, the conduction losses of the MOSFET rise more quickly than the switching losses of the IGBT. The losses at elevated temperature increase 60% for the MOSFET while the total losses for the IGBT increase only 20%. At 300 watts this makes the power almost equal, while at 500 watts the advantage goes to the IGBT.

Chart 2 - ZVS PFC @ 50kHz, 500W

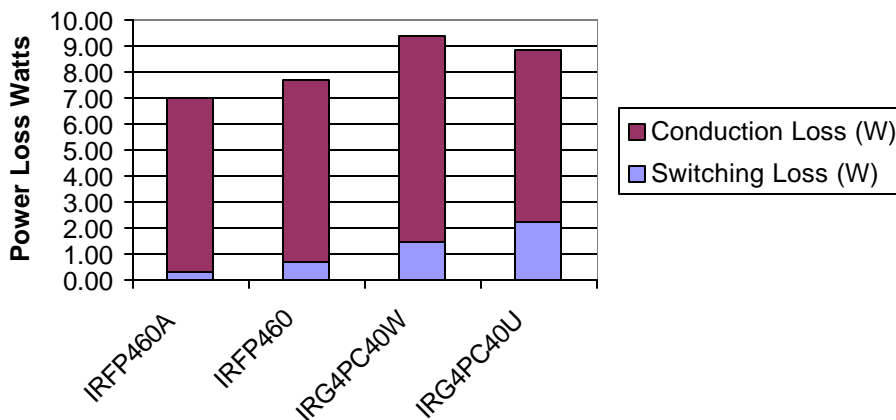
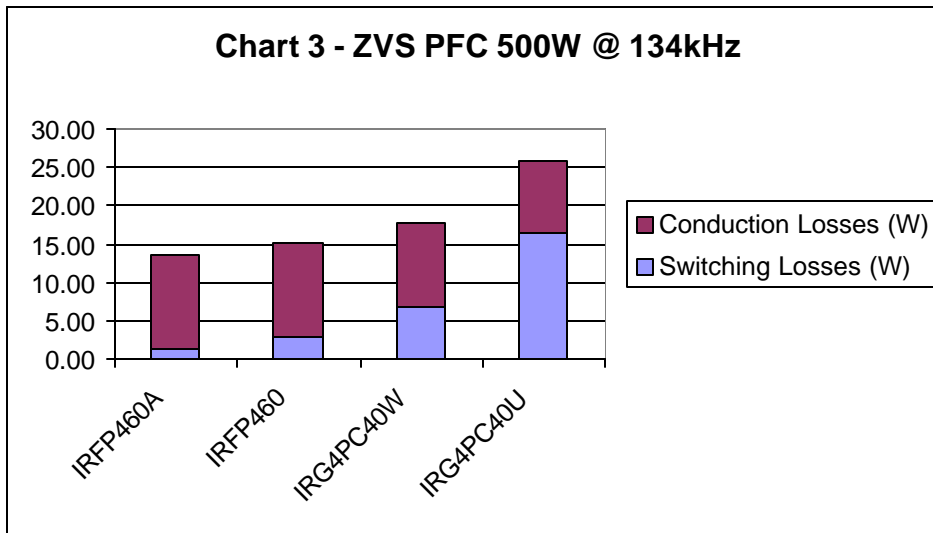

Chart 3 shows the losses at 134kHz, 500W, elevated temperature, the IGBT losses of 25.2W are slightly worse than the MOSFET, with total losses of 23.9W. At room temperature in this same application the losses were 17.8 and 15.1 watts respectively. The switching losses are higher at higher frequency which eliminates the advantage of the IGBT at high



temperature, when switching at the lower frequency. This illustrates the subject of this paper, namely there is no iron clad rule which can be used to determine which device will offer the best performance in a specific type of circuit. Depending upon the exact power level, devices being considered, the latest technology available for each type of transistor, the results will change slightly.

Conclusions

In the battle between MOSFETs and IGBTs, either device can be shown to provide the advantage in the same circuit, depending on operating conditions. How does a designer select the right device for his application? The best approach is to understand the relative performance of each device. And know that if it looks too good to be true, it probably is. Some simple things to keep in mind:

Test data, supplier claims or advertisements that select the conditions at maximum current, maximum temperature will favor the IGBT in a given application. For example, when a forklift is lifting its maximum-rated load while moving up an inclined ramp in the desert at noon.

In this specific application, the IGBT appears to be the device of choice. But when the *average* power consumption during an entire workday is considered, the maximum torque is used only 15% of the time and the average torque load of the motor is only 25% of the rated torque. Under average or typical conditions, a MOSFET provides the longest battery life while meeting all peak-performance levels — and usually at a lower cost.

Data, which select applications at the highest switching frequency, shortest pulse width or lowest current, will tend to favor the MOSFET over the IGBT. For example, a power supply operating at room temperature with nominal load and nominal line voltage will make the MOSFET appear to be better than the IGBT. Conversely, if the power supply is operated at maximum case temperature, maximum load and minimum line voltage, the IGBT will look better. Actual performance, however, is almost never under “nominal conditions.” Variations in ambient temperature, line voltage and load are more realistic and should be considered.

Presently, some of the newest IGBTs can offer competitive performance and cost advantages in zero-voltage switched PFCs at 1000 watts and above, operating at 100kHz and above. However, in all other power supply applications, the MOSFET continues to reign supreme.

Finally, there seems to be an industry wide perception that MOSFETs are a mature product, which will not offer significant performance improvements in applications and IGBTs are a new technology, which will replace MOSFETs in all applications above 300 volts. No such generalizations are ever true and the huge improvements in MOSFET performance over the last two years certainly confirms that MOSFETs are a very dynamic product, and continues a trend of rapid growth. In fact, new low-charge MOSFETs such as the International Rectifier IRFP460A and IRFP22N50A significantly move performance benchmarks just when the IGBTs appear to offer an alternative in hard-switched applications.