

General Recommendations for Assembly of Infineon Packages



Never stop thinking

Edition 2008-05

**Published by
Infineon Technologies AG
81726 München, Germany**

**© 2008 Infineon Technologies AG
All Rights Reserved.**

Legal Disclaimer

The information given in this document shall in no event be regarded as a guarantee of conditions or characteristics. With respect to any examples or hints given herein, any typical values stated herein and/or any information regarding the application of the device, Infineon Technologies hereby disclaims any and all warranties and liabilities of any kind, including without limitation, warranties of non-infringement of intellectual property rights of any third party.

Information

For further information on technology, delivery terms and conditions and prices, please contact the nearest Infineon Technologies Office (www.infineon.com).

Warnings

Due to technical requirements, components may contain dangerous substances. For information on the types in question, please contact the nearest Infineon Technologies Office.

Infineon Technologies components may be used in life-support devices or systems only with the express written approval of Infineon Technologies, if a failure of such components can reasonably be expected to cause the failure of that life-support device or system or to affect the safety or effectiveness of that device or system. Life support devices or systems are intended to be implanted in the human body or to support and/or maintain and sustain and/or protect human life. If they fail, it is reasonable to assume that the health of the user or other persons may be endangered.

Table of Contents

1	Scope and Introduction	4
2	Package Handling	6
2.1	ESD Protective Measures	6
2.1.1	ESD Protective Measures in the Workplace	6
2.1.2	Equipment for Personal	6
2.1.3	Production Installations and Processing Tools	6
2.2	Packing of Components	7
2.3	Moisture-Sensitive Components (MSL classification)	7
2.4	Storage and Transportation Conditions	8
2.5	Handling Damage and Contamination	9
2.6	Component Solderability	9
3	Printed Circuit Board	10
3.1	General Remarks	10
3.2	PCB Design	10
3.2.1	Pad Definition and Solder Mask Layer	10
3.2.2	Packages with Exposed Die Pads, Heatsinks or Heat Slugs	11
3.2.3	Pad Design for Reflow Soldering vs. Pad Design for Wave Soldering	12
3.3	PCB Pad Finishes	13
4	Mounting of THDs	14
4.1	Bending Instructions	14
4.2	Placement of THDs	15
4.3	Heatsink Mounting	15
4.4	Soldering of THDs	15
4.4.1	(Selective) Wave Soldering of THDs	15
4.4.2	Pin-in-Paste	16
4.4.3	Other Soldering Techniques	17
5	Mounting of SMDs	18
5.1	Process Flow for SMDs with Reflow Soldering	18
5.1.1	Solder Paste	18
5.1.2	Solder Paste Application	18
5.1.3	Solder Paste Inspection	20
5.1.4	Component Placement	20
5.1.5	Reflow Soldering	21
5.1.6	Processing of Moisture-Sensitive Components (MSL classification)	23
5.2	Process Flow for SMDs with Wave Soldering	23
6	Combinations of Soldering Methods/Multiple Soldering	25
7	Cleaning	26
8	Inspection	27
9	Rework	29
9.1	Tooling	29
9.2	Device Removal	29
9.3	Site Redressing	30
9.4	Reassembly and Reflow	30
10	Coating of Assembled PCBs	31
11	List of References	32

1 Scope and Introduction

These notes are intended to cover components for which no individual notes on processing are available. Because individual notes are available for most recent package families, this paper focuses on older package types such as SOs (Small Outline Packages), SOTs (Small Outline Transistor Packages), SIPs (Single In-line Packages), DIPs (Dual In-line Packages) etc. It covers both SMDs (Surface Mount Devices) and THDs (Through-Hole Devices). Furthermore, it describes how to mount SMDs and THDs with reflow and wave soldering.

This paper provides an overview of existing processes, and helps to integrate package family-related notes on processing into the wider field of Through-Hole Technology (THT) and Surface-Mount Technology (SMT).

Processes are described in very general terms, as there are the notes on processing for individual package families. Therefore, recommendations apply in the following order:

- Product specifications overrule package family-specific and general notes on processing
- Package family-specific notes on processing overrule the general notes

Through-Hole Technology and Through-Hole Devices

THT refers to the mounting scheme used for electronic components whose pins are inserted into holes drilled in Printed Circuit Boards (PCBs) and soldered to pads on the opposite side.

Accordingly, THDs, which include Infineon's leaded semiconductors, have more-or-less long pins or leads.

Figure 1 shows some typical Infineon THD packages.

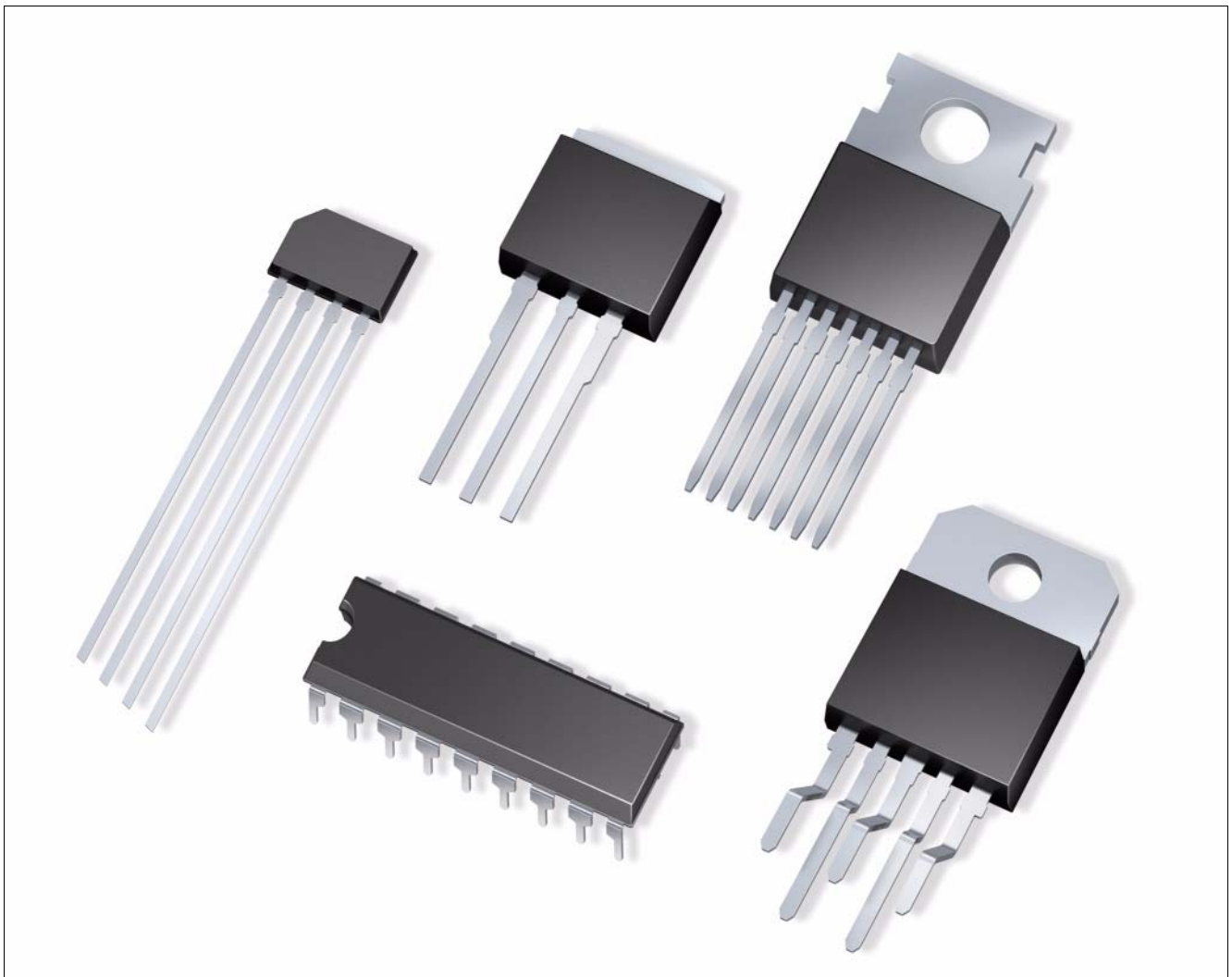

Figure 1 Typical Through-Hole Packages

Surface-Mount Technology and Surface-Mount Devices

SMT refers to the mounting scheme used for electronic components (SMDs) that are soldered directly onto the surface of PCBs. **Figure 2** shows some typical Infineon SMD packages.

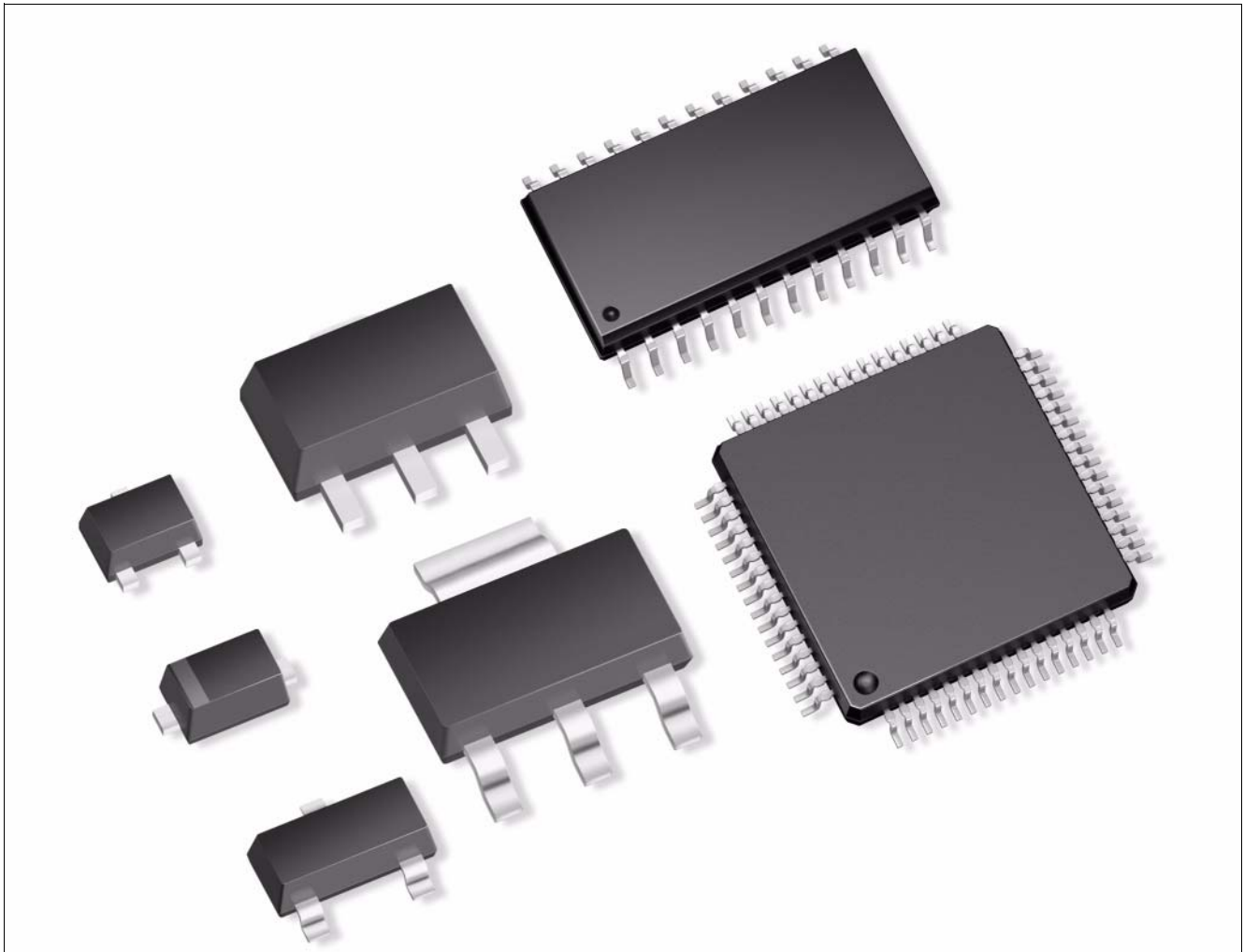

Figure 2 Typical Surface Mount Packages

Wave Soldering

Wave soldering is a large-scale process by which electronic components are soldered to a PCB to form an electronic assembly. The name is derived from the fact that the process uses a tank to hold a quantity of molten solder; the components are inserted into or placed on the PCB and the loaded PCB is passed across a pumped wave or cascade of solder. The solder wets the exposed metallic areas of the board (those not protected with solder mask), creating a reliable mechanical and electrical connection.

Reflow Soldering

Reflow soldering is the most common technique to attach components to a circuit board, and typically consists of applying solder paste, positioning the devices, and reflowing the solder in an oven with a conveyor belt. The goal of the reflow process is to melt the powder particles in the solder paste, thereby joining the appropriate surfaces, to create a strong metallurgical bond after solidification of the solder. There are usually four process zones in conventional reflow process: preheat, thermal soak, reflow, and cooling.

Most reflow ovens use forced convection, blowing hot air at different temperature in different zones. The PCBs travel through these zones on a conveyor.

Other ovens, mostly used in niche applications, are based on heat transfer by infrared or vapor-phase.

Other Soldering Techniques

Beside wave and reflow soldering, other techniques are used in special applications: selective wave soldering, laser welding and soldering, hot bar soldering, and manual soldering with solder iron and hot air guns. For details, please refer to [Chapter 4](#) and [Chapter 5](#).

Most products are qualified only for the typical soldering method(s) used in the most common applications for the product. Approval for other soldering methods is product-specific. Please refer to the product data sheet or ask your local sales, application, or quality engineer for details.

2 Package Handling

2.1 ESD Protective Measures

Semiconductor devices are normally Electrostatic Discharge Sensitive Devices (ESDS) requiring specific precautionary measures regarding handling and processing. Discharging of electrostatically charged objects over an Integrated Circuit (IC) can be caused by human touch or by processing tools, resulting in high current and/or high voltage pulses that can damage or even destroy sensitive semiconductor structures. On the other hand, ICs may also be charged during processing. If discharging takes place too quickly ("hard" discharge), it may cause load pulses and damages, too. ESD protective measures must therefore prevent contact with charged parts as well as electrostatic charging of the ICs. Protective measures against ESD must be taken during handling, processing, and the packing of ESDS. A few hints are provided below on handling and processing.

2.1.1 ESD Protective Measures in the Workplace

- Standard marking of ESD protected areas
- Access controls, with wrist strap and footwear testers
- Air conditioning
- Dissipative and grounded floor
- Dissipative and grounded working and storage areas
- Dissipative chairs
- Earth ("ground") bonding points for wrist straps
- Trolleys or carts with dissipative surfaces and wheels
- Suitable shipping and storage containers
- No sources of electrostatic fields

2.1.2 Equipment for Personal

- Dissipative/conductive footwear or heel straps
- Suitable smocks
- Wrist straps with safety resistors
- Gloves or finger coats which are ESD-proven (with specified volume resistivity)

2.1.3 Production Installations and Processing Tools

- Machine and tool parts made of dissipative or metallic materials
- No materials having thin insulating layers for sliding tracks
- All parts reliably connected to ground potential
- No potential difference between individual machine and tool parts
- No sources of electrostatic fields

Detailed information on ESD protective measures may be obtained from the ESD Specialist through Area Sales Offices. Our recommendations are based on the internationally applicable standards IEC 61340-5-1 and ANSI/ESD S2020.

2.2 Packing of Components

Different packings like fixtures e.g. for feeding components in an automatic pick & place machine (tape & reel, trays,...) and surrounding bags and boxes to prevent damages during transportation or storage are available depending on component and customer needs. Please refer to product and package specifications (on the IFX homepage) and our sales department to get information about what packing is available for a given product.

Generally the following list of standards dealing with packing should be considered if applicable for a given package and packing:

IFX packs according to the IEC 60286-* series

- IEC 60286-3 Packaging of components for automatic handling - Part 3:
Packaging of surface mount components on continuous tapes
- IEC 60286-4 Packaging of components for automatic handling - Part 4:
Stick magazines for dual-in-line packages
- IEC 60286-5 Packaging of components for automatic handling - Part 5:
Matrix trays

Moisture-sensitive Surface Mount Devices are packed according to IPC/JEDEC J-STD-033*:
Handling, Packing, Shipping and Use of Moisture/Reflow Sensitive Surface Mount Devices

Detailed packing drawings: [Packing Information \(Internet\)](#)

Other references:

- ANSI/EIA-481-* Standards Proposal No. 5048, Proposed Revision of ANSI/EIA-481-B 8 mm through 200 mm Embossed Carrier Taping and 8 mm & 12 mm Punched Carrier Taping of Surface Mount Components for Automatic Handling (if approved, to be published as ANSI/EIA-481-C)
- EIA-783 Guideline Orientation Standard for Multi-Connection Package (Design Rules for Tape and Reel Orientation)

2.3 Moisture-Sensitive Components (MSL classification)

For moisture-sensitive packages, it is necessary to control the moisture content of the components. Penetration of moisture into the package molding compound is generally caused by exposure to ambient air. In many cases, moisture absorption leads to moisture concentrations in the component that are high enough to damage the package during the reflow process. Thus it is necessary to dry moisture-sensitive components, seal them in a moisture-resistant bag, and only remove them immediately prior to board assembly to the PCB. The permissible time (from opening the moisture barrier bag until the final soldering process), which a component can remain outside the moisture barrier bag, is a measure of the sensitivity of the component to ambient humidity (Moisture Sensitivity Level, MSL). The most commonly applied standard IPC/JEDEC J-STD-033* defines eight different MSLs (see [Table 1](#)). Please refer to the “Moisture Sensitivity Caution Label” on the packing material, which contains information about the moisture sensitivity level of our products. IPC/JEDEC-J-STD-20 specifies the maximum reflow temperature that shall not be exceeded during board assembly at the customer’s facility.

Table 1 Moisture Sensitivity Levels (according to IPC/JEDEC J-STD-033*)

Level	Floor Life (out of bag)	
	Time	Conditions
1	Unlimited	≤30°C / 85% RH
2	1 year	≤30°C / 60% RH
2a	4 weeks	≤30°C / 60% RH
3	168 hours	≤30°C / 60% RH
4	72 hours	≤30°C / 60% RH
5	48 hours	≤30°C / 60% RH
5a	24 hours	≤30°C / 60% RH
6	Mandatory bake before use. After bake, must be reflowed within the time limit specified on the label.	≤30°C / 60% RH

If moisture-sensitive components have been exposed to ambient air for longer than the specified time according to their MSL, or the humidity indicator card indicates too much moisture after opening a Moisture Barrier Bag (MBB), the components have to be baked prior to the assembly process. Please refer to IPC/JEDEC J-STD-033* for details. Baking a package too often can cause solderability problems due to oxidation and/or intermetallic growth. In addition, packing material (e.g. trays, tubes, reels, tapes, ...) may not withstand higher baking temperatures. Please refer to imprints/labels on the respective packing to determine allowable maximum temperature.

For lead-free components two MSLs can be given: One for a lower reflow peak temperature (tin-lead) and one for a higher reflow peak temperature (lead-free). Each one is valid for the respective application.

2.4 Storage and Transportation Conditions

Improper transportation and unsuitable storage of components can lead to a number of problems during subsequent processing, such as poor solderability, delamination, and package cracking effects.

These standards should be taken into account:

- IEC 60721-3-0 Classification of environmental conditions: Part 3:
Classification of groups of environmental parameters and their severities; introduction
- IEC 60721-3-1 Classification of environmental conditions: Part 3:
Classification of groups of environmental parameters and their severities; Section 1: Storage
- IEC 60721-3-2 Classification of environmental conditions: Part 3:
Classification of groups of environmental parameters and their severities; Section 2: Transportation
- IEC 61760-2 Surface mounting technology - Part 2:
Transportation and storage conditions of surface mounting devices (SMD) - Application guide
- IEC 62258-3 Semiconductor Die Products - Part 3:
Recommendations for good practice in handling, packing and storage
- ISO 14644-1 Clean rooms and associated controlled environments Part 1:
Classification of airborne particulates

Table 2 General Storage Conditions - Overview

Product	Condition for Storing
Wafer/Die	N2 or MBB ¹⁾ (IEC 62258-3)
Component - moisture sensitive	MBB (JEDEC J-STD-033*)
Component - not moisture sensitive	1K2 (IEC 60721-3-1)

1) MBB = Moisture Barrier Bag

Maximum Storage Time

The conditions to be complied with in order to ensure problem-free processing of active and passive components are described in standard IEC 61760-2.

Internet links to standards institutes

[American National Standards Institute \(ANSI\)](#)

[Electronics Industries Alliance \(EIA\)](#)

[Association Connecting Electronics Industries \(IPC\)](#)

2.5 Handling Damage and Contamination

Automatic or manual handling of components in or out of the component packing may cause mechanical damage to package leads and/or body. In particular, unintentional bending of leads may cause a loosening in the package body which can result in electrical malfunction.

Generally the components in the packing are ready to use. Intentional bending is sometimes needed to prepare through hole devices prior to mounting (insertion). In this case, the bending instructions in [Chapter 4.1](#) have to be followed.

Any contamination applied to component or packing may cause or induce processes that (together with other factors) may lead to a damaged device. The most critical issues are:

- Solderability problems
- Corrosion
- Electrical shorts (due to conductive particles)

2.6 Component Solderability

The sufficiently thick and wettable metal surfaces (final plating) or solder depots/balls of most semiconductor packages assure good solder ability, even after a long storage time. **Note that the cut edges of the pins should be ignored in any assessment of solderability.** Suitable methods for the assessment of solderability can be derived from JESD22B 102 or IEC60068-2-58.

Please be aware that components may be post-mold plated with tin-lead mixtures (SnPb) or pure tin (Sn), or preplated with noble metals such as gold (Au) and/or palladium (Pd) on nickel (Ni) carrier (e.g. NiAu, NiPdAu). The composition of the terminals for components with solder spheres or bumps may be either lead (Pb-) based, near-eutectic SnPb, or Pb-free. Tin-plated components are compatible with both SnPb and Pb-free soldering. For components with bumps and spheres, limited compatibility has to be considered for Pb-free terminations to SnPb paste and vice versa.

Please refer to the product data sheet and the notes about green products on the IFX homepage if another combination has to be used. Please ask your local sales, application, or quality engineer for further support.

3 Printed Circuit Board

3.1 General Remarks

Generally, PCB design and construction are key factors for achieving a high board assembly yield and board level reliability. Examples are size and type of board pads, optimal thermal and electrical connection, via design and board finish.

Due to these influences this document is just a guideline to support our customers in board design. Studies at individual customers' facilities may also be necessary for optimization, in order to take into account the actual PCB manufacturer's capability, the customer's processes, and product-specific requirements.

3.2 PCB Design

Concerning the PCB pad design for the leads, please refer to the Footprint of the respective package. It can be found in the Infineon Internet under -> products -> packages -> respective package (e.g. PG-LQFP-100-3) -> footprint. Please be aware that for some package families, dedicated customer recommendations exist. These can also be found on the IFX web site by searching for the respective package entry.

As a general guideline, see IPC 7351/7355. (Generic Requirements for Surface Mount Design and Land Pattern Standard)

3.2.1 Pad Definition and Solder Mask Layer

Generally, two basic types of solder pads are used.

- Solder Mask Defined (SMD) pad (**Figure 3**): The copper metal pad is larger than the solder mask opening above this pad. Thus the pad area is defined by the opening in the solder mask.

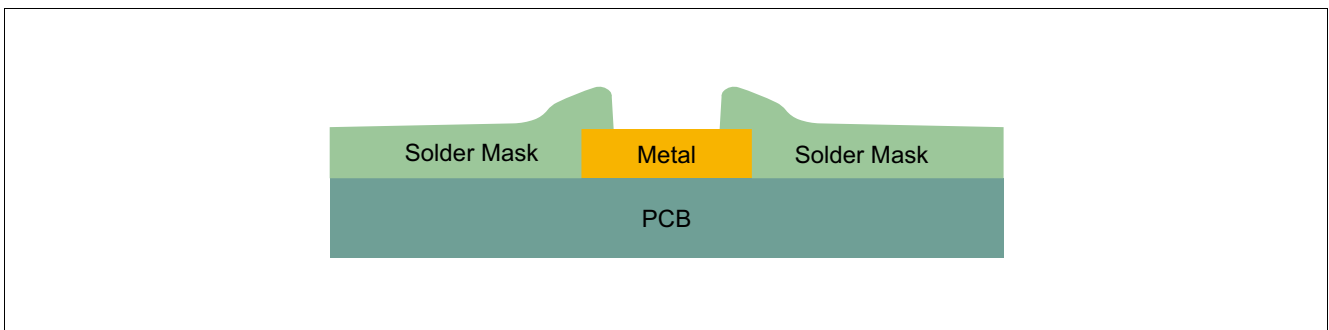

Figure 3 SMD Pad

- Non-Solder Mask Defined (NSMD) pad (**Figure 4**): Around each copper metal pad there is solder mask clearance. Dimensions and tolerances of the solder mask clearance have to be specified to ensure that the solder pad is not overlapped by the solder mask. Depending on the PCB manufacturer's tolerances, 75 µm is a widely used value.

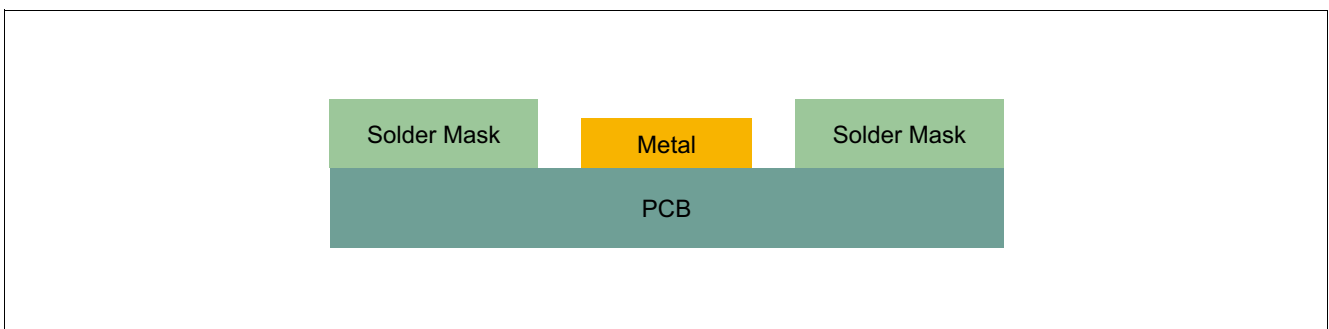

Figure 4 NSMD Pad

We recommend the NSMD type for smaller solder pads, because the tolerances of the copper pads are lower than the solder masking process tolerances. For NSMD pad, the side walls of the copper can also be wetted. This can result in a significant bigger wettable surface for small pads and therefore increase reliability.

Solder mask reduces the risk of solder bridging. Therefore it should be applied between all copper pads that are electrically separated.

Solder mask can also be used to divide big copper areas into smaller wettable areas. This often improves SMT processability and creates better balanced solder joints.

3.2.2 Packages with Exposed Die Pads, Heatsinks or Heat Slugs

In most applications, the die pad allows a large amount of heat to be transferred into the PCB to achieve higher thermal performance. Therefore the die pad should be soldered to the board on a “thermal” pad. This also increases solder joint reliability, and electrical performance for some applications/products.

Exposed die pads require reflow soldering. Wave soldering is not possible.

Generally it is possible to match the board and exposed pad layout 1:1.

If the exposed die pad protrudes from one or more sides of the package body, it may be helpful to increase the board pad size slightly in this area to get a better self-centering of the component during reflow soldering.

If the exposed die pad is fully hidden under the package body or even surrounded by peripheral pads, it may be helpful to decrease the board pad size to get more space for routing and vias for these peripheral pads.

To connect the exposed die pad thermally and electrically to inner and/or bottom copper planes of the board, plated through-hole vias are used. They help to distribute the heat into the board area, which penetrates from the chip over the package die pad and the solder joint to the thermal pad on the board.

A typical hole diameter for such thermal vias is 0.2 to 0.4 mm. This diameter and the number of vias in the thermal pad depend on the thermal requirements of the end product, the power consumption of the product, the application, and the construction of the PCB. However, an array of thermal vias with pitch 1.0 - 1.2 mm can be a reasonable starting point for most products/applications for further optimization. Thermal and electrical analysis and/or testing are recommended to determine the minimum number needed.

If the vias remain open during board manufacturing, solder may flow into the vias during board assembly (“solder wicking”). This results in lower stand-off (which is mostly controlled by the solder volume between package die pad and thermal pad on PCB), and/or solder protruding from the other side of the board, which may interfere with a second solder paste printing process on the opposite side of the board. To prevent solder from beading, a wettable surface should surround these vias to act as a buffer for the surplus solder.

Under certain conditions, open vias could have the effect of large voids in the “thermal” solder joint under the die pad, but in general, the open vias serve as venting holes for gas in the solder joint.

If necessary, the solder wicking can be avoided by plugging (filling with epoxy) and overplating the vias. If very small vias-so-called microvias (approximately 100 µm in diameter)-are used, it is in general sufficient to overplate the vias and fill them with copper. In both cases, it is necessary to specify a planar filling. However, flat dents tend to increase voiding because they serve as traps for voids forming during reflow soldering.

Another method is called tenting. The vias in this case are covered with solder mask (e.g. dry-film solder mask). Via tenting must be done from the top because the voiding rate from the bottom side is significantly higher. Combined with a intelligent solder-mask layout for the thermal pad, this method leads to good SMT processability and balanced solder joints.

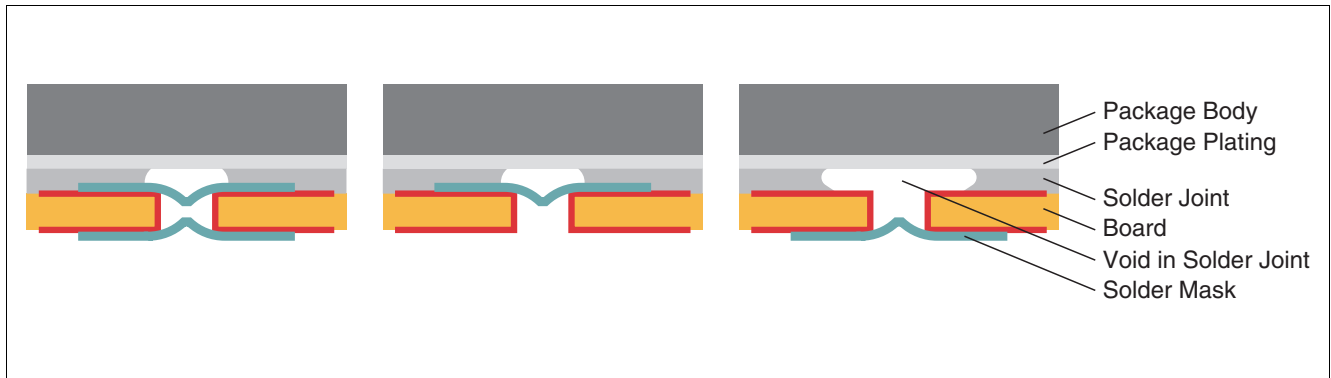

Figure 5 Different Methods for Tenting: solder mask tenting from both sides (left), only from front side (middle) and only from bottom side (right) and their possible impact on void formation.

3.2.3 Pad Design for Reflow Soldering vs. Pad Design for Wave Soldering

In most cases, reflow soldering requires board pad designs that are different from those used for wave soldering. For reflow soldering, the size of the signal pads is usually equal to or slightly larger than to the package terminals or pads. Decreased board pads are only used for area array packages (mainly to increase reliability) or exposed die pads (mainly to get more space for routing). Mismatched board pad sizes could lead to:

- Swimming/skewing (package leads move parallel to the PCB plane during reflow soldering) and/or tombstoning (package leads lift off during reflow soldering) caused by unbalanced and/or increased wetting forces
- Electrical opens or shorts
- Decreased reliability

By comparison to reflow soldering, board pads for wave soldering must be big, extending far into the package surrounding area. Most SMD bodies push away the molten solder and therefore direct wetting of the component leads is difficult. Wetting generally occurs first on the board pad. Then the solder-wetting front propagates in the direction of the component lead and finally wets the whole lead.

3.3 PCB Pad Finishes

The solder pads have to be easy for the solder paste to wet. In general, all finishes are well-proven for SMT assembly, but the quality of the plating/finish is more important for fine pitch applications in particular. Because of the uneven surface of Hot Air Solder Leveling (HASL) finish, lead-free or lead-containing HASL is less preferred for assembly (especially for pitches < 0.65 mm) compared to completely “flat” platings such as Cu-OSP (OSP: Organic Solderability Preservative) or electroless Sn or NiAu.

From a package point of view, it is difficult to recommend a certain PCB pad finish that will always meet all requirements. The choice of finish also depends strongly on board design, pad geometry, all components on the board, and process conditions, and must be chosen accordingly to the specific needs of the customer.

Table 3 Typical PCB Pad Finishes

Finish	Typ. Layer Thickness [µm]	Properties	Concerns
HASL (SnAg) (Hot Air Solder Leveling)	> 5	low cost, widely usage, know how in fabrication	uneven surface, formation of humps, flatness of single pads has to be good for fine pitch applications
Electroless Tin	0.3 - 1.2	solder joint consists only of copper and solder, no further metal is added to the solder joint	long-term stability of protection may be a concern, baking of PCB may be critical
Electroless Silver	0.2 - 0.5	solder joint consists only of copper and solder, no further metal is added to the solder joint	long-term stability of protection may be a concern, baking of PCB may be critical
Electroless Ni / Immersion Au (ENIG)	3 - 7 / 0.05 - 0.15	good solderability protection, high shear force values	expensive, concerns about brittle solder joints
Galvanic Ni/Au	> 3 / 0.1 - 2	only for thicker layers, typically used for connectors	expensive, not recommended for solder pads
OSP (Organic Solderability Preservatives)	Typical 1	low cost, simple, fast and automated fabrication	must be handled carefully to avoid damaging the OSP; not as good long-term stability as other coatings; in case of double-sided assembly only suitable with inert gas during reflow

4 Mounting of THDs

4.1 Bending Instructions

To insert the terminals of THDs in the holes of the PCB, the terminals may have to be bent to a certain pitch of the solder pads.

Please follow these guidelines:

- The minimum distance between package body and bending should be 2.5 mm (**Figure 6a** & **Figure 6b**). The leads must not be bent directly at the package. (**Figure 6c**).
- The minimum bend radius must be 0.5 mm
- During bending, a clamp should be used that prevents mechanical forces such as pulling and shearing to occur between the leads and the package body. The part of the lead between the point of bending and the package must be relieved of tensile stress during the bending process (**Figure 7a** & **Figure 7b**). Furthermore, clamping helps to keep the bends consistent in shape.
- The tensile strength of the leads from the clamp to the point where the bending force is applied should not exceed a certain force. This maximum force (typically 20 N) is mainly dependent on the cross-sectional area of the lead.
- Bending the leads parallel to the lead plane is not allowed (**Figure 7c**).
- Manual bending is acceptable if the procedures above are followed.
- For details and special arrangements, please refer to the product data sheet. For some package families, special notes describe the bending and clamping in more detail.

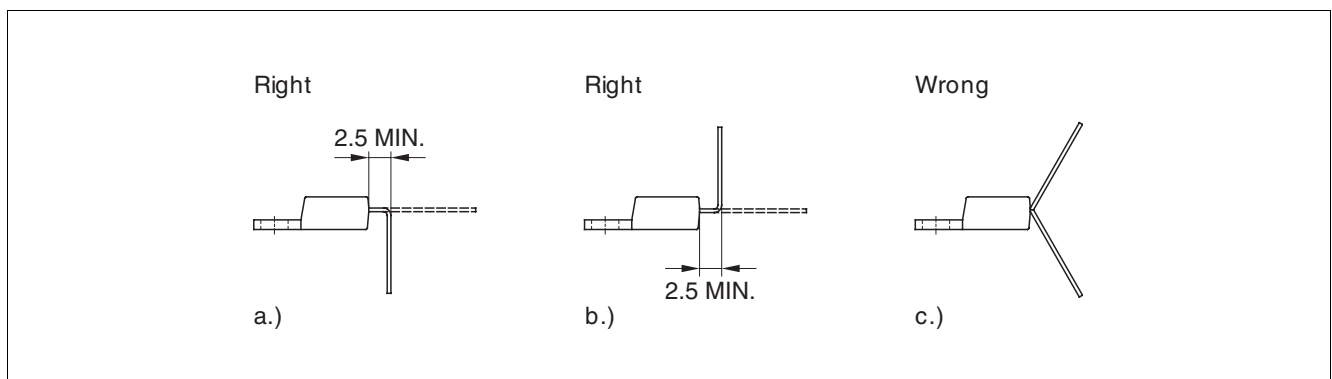

Figure 6 Examples of Bent Leads of THDs

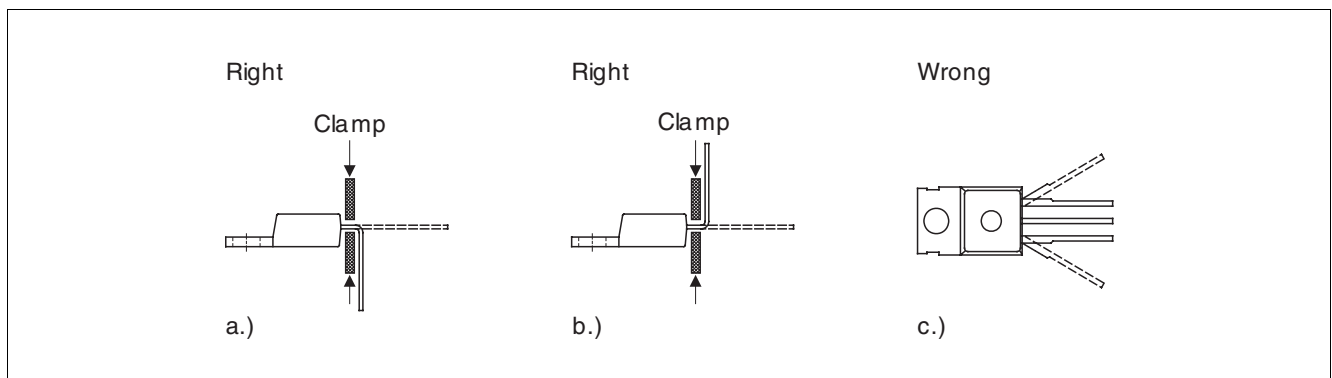

Figure 7 Examples of Lead Bending

4.2 Placement of THDs

The insertion of THDs is either done with special automatic equipment or manually. Special care has to be taken to avoid damaging deformation or violent bending during this insertion. The diameter of the drill holes in the PCB must match the tolerances of component leads, as must drill hole position and placement accuracy.

Normally, after insertion the leads are bent slightly to attach the component to the PCB until soldering. Please take care that this does not lead to stress and cause defects at the interconnect between leads and package body.

4.3 Heatsink Mounting

For special packages with high power dissipation, a heatsink can be applied prior to or after soldering.

Alternative methods are:

- Screw mounting
- Clip mounting
- Reflow soldering

The details are described in special notes or data sheets for a given package family or product (e.g. "Recommendations for Assembly of Infineon P(G)-TO Packages")

4.4 Soldering of THDs

THDs are typically wave soldered. The number of THDs on a board is steadily decreasing in some applications, making wave soldering less and less cost-effective. Therefore, the small number of THDs (mostly connectors and special components) are soldered with selective wave soldering or with pin-in-paste technique and reflow soldering.

4.4.1 (Selective) Wave Soldering of THDs

Wave soldering is a technique in which the leads are exposed to molten solder. For THDs, only the leads that extend through the drill holes in the PCB are directly in contact with the hot solder. The body of the package is heated through the thermal-conductive leads, which has two consequences:

1. The package body is cooler than in the case of reflow soldering.
2. The temperature gradient between leads and body and inside the package is greater compared to reflow soldering

Therefore, for wave soldering usable THDs, the heat resistance is tested according to JESD22-B106 and IEC668 2-20 (260°C, 10 s).

This gives the maximum temperature and time for (selective) wave soldering (for dual wave: max. time in wave 1 + max. time in wave 2 < 10 s).

There are many types of wave soldering machines. However, the basic components and principles of these machines are the same. A standard wave solder machine consists of three zones: the fluxing zone, the preheating zone, and the soldering zone. An additional fourth zone, cleaning, is used depending on the type of flux applied.

Dual-wave soldering is the most commonly used method. **Figure 8** shows a typical temperature profile. The peak temperatures, ramp rates, and times depend on the materials and the wave soldering equipment used.

The first wave has a turbulent flow and therefore guarantees wetting of nearly all shapes of leads and board pads, but also creates some solder bridges. These solder bridges have to be removed by the second wave, which has a laminar flow.

When using lead-free solder alloys, a nitrogen atmosphere is recommended.

Selective wave soldering is used when only a few THDs have to be soldered onto the board. Generally this is done after the other components are already soldered by reflow soldering. These components undergoing selective wave soldering must be protected either by using special fixtures and deflectors for the PCB and/or having a small wave shape that is created by using special wave guiding tubes or covers.

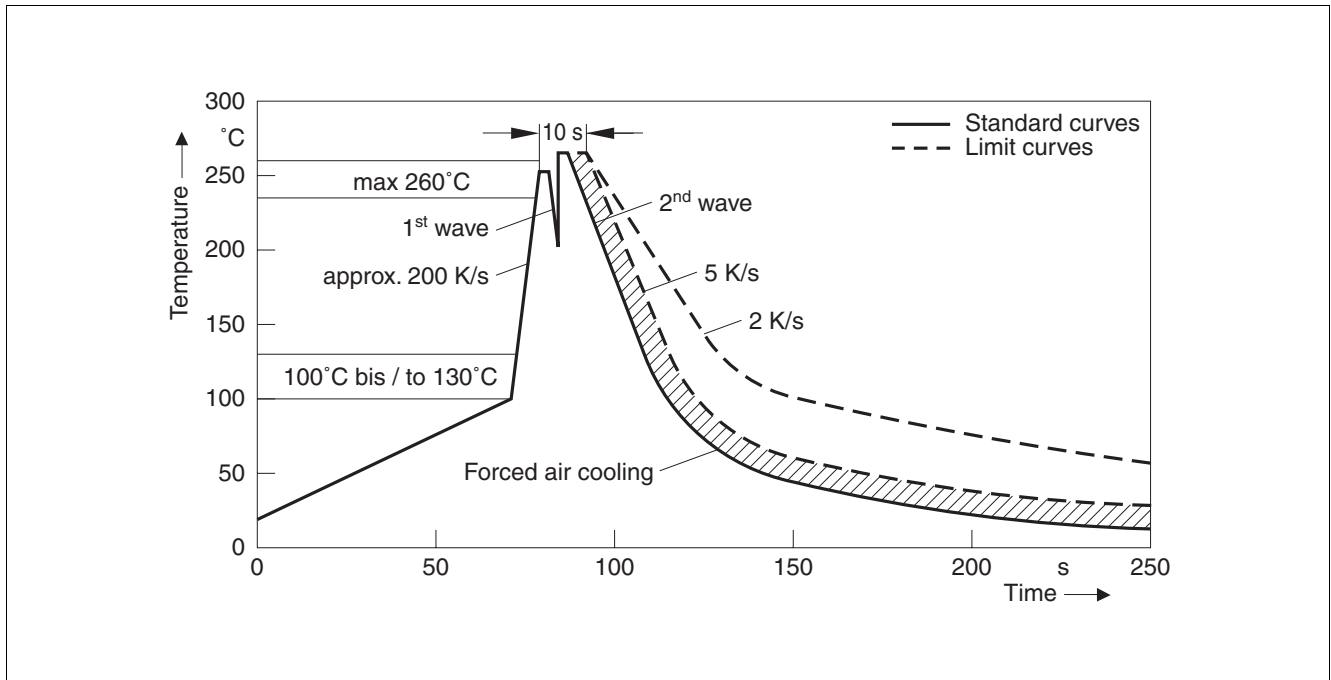

Figure 8 Typical Dual-wave Soldering Profile

4.4.2 Pin-in-Paste

Another technique to solder THDs is to print solder paste onto a PCB near or over drill holes through which the leads are inserted. The reflow of the paste is done together with reflow soldering of SMDs.

To get reliable solder joints, it is necessary to increase the amount of solder for the leads, board pads, and drill holes compared to SMDs. Therefore the solder paste application for THDs has to be changed to get more solder paste onto the board. Several methods in use are:

- Overprinting
- Step stencil
- Solder paste dispensing

The amount of solder paste has to be adjusted to ensure that after reflow, the drill holes are filled to a certain amount (comparable to wave soldering quality) and there is enough solder left to form a proper solder fillet.

For Pin-in-Paste, the THDs have to go through the reflow temperature profile. Therefore:

- The temperature is nearly the same for the whole package compared to wave soldering.
- The time for which the peak temperature is applied to the package is much longer compared to wave soldering.

Therefore for THDs that are reflow solderable and can be subjected to Pin-in-Paste, their heat resistance is tested according to J-STD-020.

This gives the maximum temperature, maximum times at or above certain temperatures, and maximum temperature gradients for reflow soldering.

For an appropriate reflow soldering profile, please refer to [Chapter 5.1.5](#).

4.4.3 Other Soldering Techniques

There is wide field of soldering techniques (mostly used in niche applications) that cannot be tested for every component. Some general guidelines should be followed:

- The maximum temperature of the package body and leads must not exceed the maximum allowed temperature for reflow or wave soldering.
- The maximum allowed time at high temperatures must not exceed the maximum allowed time for reflow or wave soldering.
- If heat is applied to the leads, the maximum temperatures in the package and of the package body must not exceed the maximum allowed temperatures during reflow or wave soldering.

For details and special arrangements, please refer to the product data sheet and/or qualification report. For example, the given moisture sensitivity level for the given product and preconditioning permitted by J-STD-020 shows the maximum temperatures and times for hot air soldering.

The most common method for manual soldering of THDs is to use soldering irons. Hot air guns are also used, especially if many leads have to be heated.

In any case, mechanical or thermo-mechanical overstress during manual handling and soldering, (especially contact between the soldering iron or hot air gun and the package) has to be avoided.

5 Mounting of SMDs

SMDs are usually soldered to the board by reflow soldering or wave soldering.

The whole process flow is then adapted to the soldering method. For reflow soldering, the solder paste has to be applied to the PCB. For wave soldering, an adhesive has to attach the component to the PCB while running through the molten solder (please refer to [Chapter 5.2](#)).

Please take into account that the thermal stress differs significantly for the two methods. Wave soldering applies a short but heavy thermo-mechanical shock, and therefore most SMDs are not approved for this soldering technique. Please refer to the label on the component packing and/or other component specifications for the appropriate soldering method.

Generally wave soldering is not recommended for or impossible to apply to:

- Laminate substrates
- Pads or balls underneath the package body (e.g. BGAs, LGAs)
- Heatsinks or exposed pads under the package body (e.g. QFNs, QFPs and DSOs with exposed pads)

5.1 Process Flow for SMDs with Reflow Soldering

A typical flow for mounting SMDs is shown in [Figure 9](#).

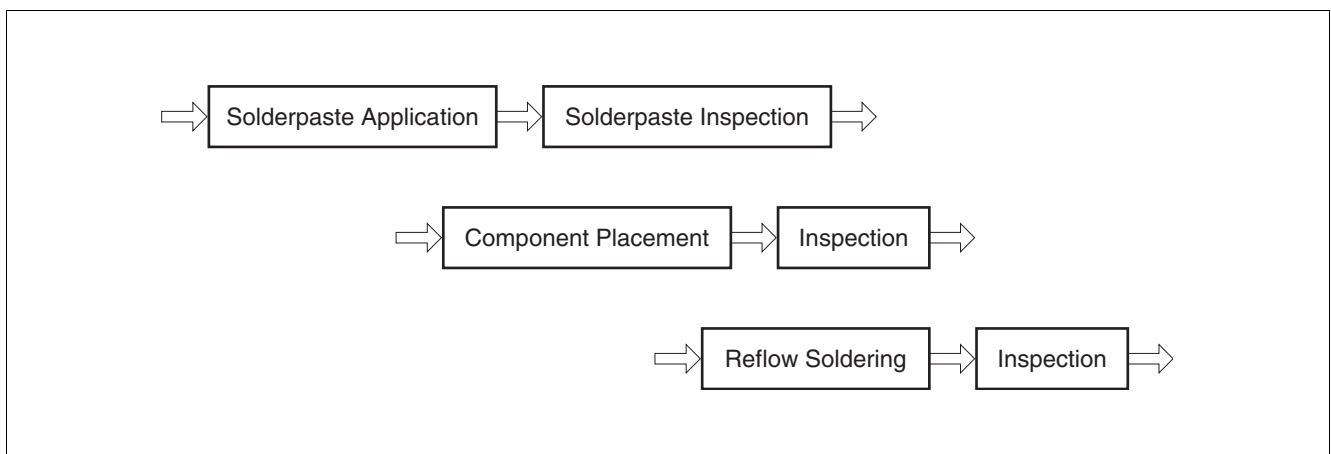

Figure 9 Typical Flow for Mounting SMDs

5.1.1 Solder Paste

Solder paste consists of solder alloy and a flux system. Normally the volume is split into about 50% alloy and 50% flux and solvents. In term of mass, this means approximately 90 wt% alloy and 10 wt% flux system and solvents. The flux system has to remove oxides and contaminants from the solder joints during the soldering process. The capability of removing oxides and contaminants depends on the activation level of the used flux.

The contained solvent adjusts the viscosity needed for the solder paste application process. The solvent has to evaporate during reflow soldering.

The metal alloy in Pb-containing solder pastes is typically eutectic SnPb or near eutectic SnPbAg. In lead-free solder pastes, so-called SAC-alloys can be found (SAC stands for SnAgCu; typically 1 - 4% Ag and < 1% Cu). A “no-clean” solder paste is preferred for all packages where cleaning underneath the component (e.g. leadless packages, packages with exposed die pads) is difficult. The paste must be suitable for printing the solder stencil aperture dimensions; type 3 paste is recommended. Solder paste is sensitive to age, temperature, and humidity. Please comply with the handling recommendations of the paste manufacturer.

5.1.2 Solder Paste Application

Generally the solder paste is applied onto the PCB metal pads by stencil printing. Screen printing or dispensing is used only for special applications.

The volume of the printed solder paste using screen printing is determined by the screen opening and the screen mesh.

The volume of the printed solder paste using stencil printing is determined by the stencil aperture and the stencil thickness.

In most cases, the solder paste volume and therefore the screen mesh and the stencil thickness have to be matched to the specifications of all components on the PCB.

Using solder paste dispensing enables a wide range of solder paste volumes. As a sequential method, it is less favourable for high-volume production.

For packages in which all leads are of the same size, a typical screen opening or stencil aperture is reduced to 90% of the PCB pad size.

For packages in which the leads are of different sizes, the solder paste volume has to be matched properly by using appropriate screen openings and stencil apertures to avoid swimming, tilting, solder beading, or tombstoning.

Especially large exposed pads in the center of the component tend to tilt the component if the solder paste volume is not reduced sufficiently. Melted solder always tends to form a spherical shape (lowest surface tension) and therefore big pads that are fully covered with solder paste will give a higher stand-off after reflow than smaller pads. This can cause tilting of the component, so the different solder portions have to be adjusted.

A segmentation of the stencil for exposed pads or other big pads is shown in the following illustration (Figure 10). The diagram also shows open vias that are located in the cross-over points of the segmentation, which prevents direct printing of solder paste into these vias.

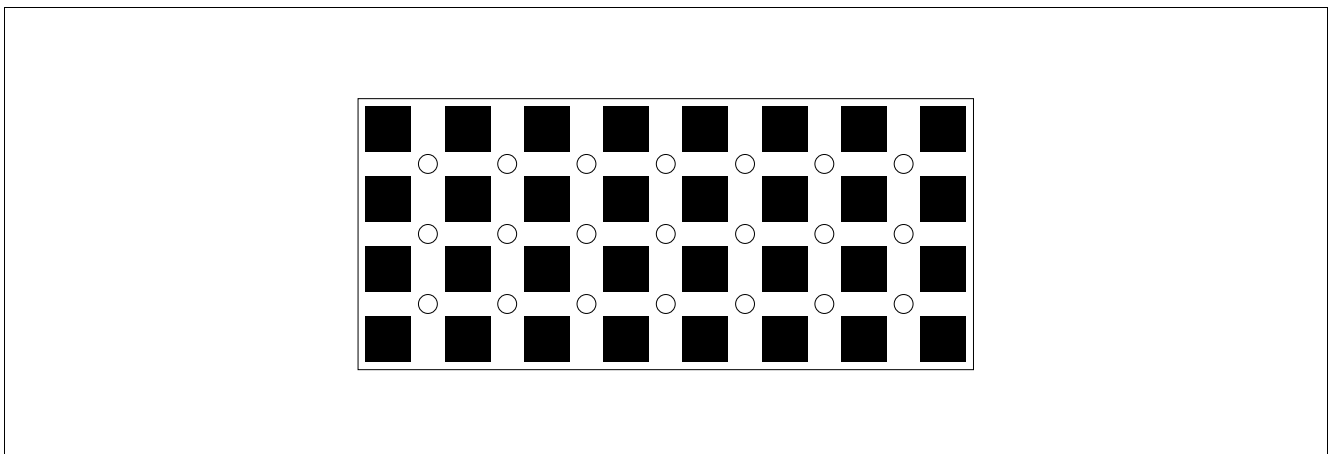

Figure 10 Stencil Segmentation and Via Locations for Exposed Die Pads

Because the stand-off also depends on the wetting behaviour of the board finish, the optimum volume has to be determined by the customer, taking into account the via technology used.

Beside the target stand-off and/or solder-joint volume, the stencil thickness is also determined by the smallest aperture of the stencil.

The following rule of thumb can be applied:

$$A_{\text{apert}} > F \times A_{\text{wall}}$$

A_{apert} : area of the aperture in the stencil

e.g. for a round aperture with radius r : $A_{\text{apert}} = \pi \times r^2$

A_{wall} : area of the wall of the aperture

e.g. for a round aperture with radius r and stencil thickness d : $A_{\text{wall}} = 2\pi \times r \times d$

F : feasibility factor, which depends on the stencil and printing process quality and the used solder paste

e.g. for conservative processes: $F = 0.8$; for advanced processes: $F = 0.6$

To ensure a uniform and high solder paste transfer to the PCB, laser-cut (mostly made from stainless steel) and electroformed stencils (nickel) are preferred. Rounding the corners of rectangular apertures (radius ~50 μm) can also support good paste release, and a factor $F = 0.6$ can be achieved.

5.1.3 Solder Paste Inspection

For inspection of solder paste depots after printing, vision systems that are either integrated into the printer or separate Automatic Optical Inline (AOI) equipment can be used.

The solder paste x-y-cover and solder paste volume can be measured. Adequate acceptance criteria have to be defined. 80% of maximum cover and volume are achievable values in mass production.

5.1.4 Component Placement

Although the self-alignment effect due to the surface tension of the liquid solder will support the formation of reliable solder joints, the components have to be placed accurately according to their geometry. Positioning the packages manually is not recommended, but it is possible, especially for packages with big terminals and wide pitch.

For packages with a pad width of 0.3 mm or less and a pitch of 0.65 mm or less, an automatic pick-and-place machine is recommended to achieve reliable solder joints.

Component placement accuracies of $\pm 50 \mu\text{m}$ are obtained with modern automatic component- placement machines using vision systems. With these systems, both the PCB and the components are optically measured and the components are placed on the PCB at their programmed positions. The fiducials on the PCB are located either on the edge of the PCB for the entire PCB or additionally on individual mounting positions (local fiducials). They are detected by a vision system. Recognition of the packages immediately before the mounting process is performed by a special vision system, enabling the complete package to be correctly centered.

The maximum tolerable displacement of the components is 20% of the metal pad width on the PCB (for NSMD pads). Consequently, for exposed die pad LQFP packages with 0.5 mm lead pitch for example, the device pad to PCB pad misalignment has to be better than 50 μm to assure a robust mounting process. Generally this is achievable with a wide range of placement systems.

The following recommendations are important to follow:

- Especially on large boards, local fiducials close to the device can compensate for PCB tolerances.
- The lead recognition capabilities of the placement system should be used, not the outline centering. Outline centering can only be used for packages in which the tolerances between pad and outline are small compared to the placement accuracy needed.
- To ensure the identification of the packages by the vision system, adequate lighting and the correct choice of measuring modes are necessary. Accurate settings can be taken from the equipment manuals.
- Placement force that is too high can squeeze out solder paste and cause solder joint shorts. On the other hand, placement force that is too low can lead to insufficient contact between package and solder paste and may result in insufficient sticking of the component on the solder paste, which furthermore may lead to shifted or dropped devices.
- A pick-up nozzle suitable for the package body size should be used. The nozzle should be slightly smaller than the package body. A nozzle that is too big may lead to an irregular force distribution, especially to increased forces at the edges of the package body. On the other hand, a nozzle that is too small may lead to increased force in the package center. For package bodies that are divided into different areas that have different heights please take special care when choosing the nozzle. Nozzle shape and size are probably more critical in these cases.

5.1.5 Reflow Soldering

Soldering determines the yield and quality of PCBA (PCB Assembly) to a very large extent. Generally standard reflow soldering processes such as:

- Forced convection
- Vapor phase
- Infrared (with restrictions)

and typical temperature profiles are suitable for board assembly.

During the reflow process, each solder joint has to be exposed to temperatures above the melting point of solder (i.e. liquidus of the solder alloy) for a sufficient time to get the optimum solder joint quality, whereas overheating the PCB with its components has to be avoided. Please refer to the bar code label on the packing for the maximum package body temperature. It is important that the maximum temperature of the package during the reflow does not exceed the specified peak temperature on the moisture level caution label on the packing (see also [Chapter 5.1.6](#)).

When using infrared (IR) ovens without convection, special care may be necessary to assure a sufficiently homogeneous temperature profile for all solder joints on the PCB, especially on large, complex boards with different thermal masses of the components. Using infrared soldering, the components are heated as a result of absorbing IR radiation. Usually the heating is done with radiators positioned on either side in order to heat or preheat the whole area surrounding of the solder joint, if possible. The temperature of the different components may vary severely. Since the metallic terminals of the components exhibit only low absorption, i.e. they reflect IR radiation, the heat has to be supplied to the solder joints via the component itself, the similarly heated PCB, and the ambient air.

Absorption depends on the material and the wavelength, and the latter, in turn, on the radiator temperature. Large and thick SMDs take longer to get hot than small and thin ones do. Special care has to be taken if large Area Array Components (e.g. xxGAs) are soldered by IR radiation, because the solder joints between the package and the PCB are heated up much more slowly than the environment. Precautions must be taken by empirically varying the different radiator temperature and the conveyor speed to ensure that the process does not drop below the minimum soldering temperature or exceed the maximum allowable temperature at any point. This must be ensured by specific temperature measurements.

Compared to forced convection and especially infrared soldering, a vapor-phase oven provides the least risk of overheating because it limits the temperature by using special fluids with a vapor temperature slightly above the melting point of the solder alloy. The atmosphere is free from oxygen. One disadvantage is that most vapor phase ovens are batch ovens and not conveyor-driven. This makes it difficult to implement them in mass production lines.

The most frequently recommended reflow type normally used in mass production is forced convection. The heat is transferred to the PCB in different zones by heated air or nitrogen. The number of zones, volume of hot gas, and oven design determine the capacity and the ability to reproduce the optimum reflow profile, which is also influenced by:

- Board thickness and layout
- Differences in thermal mass of all components
- Maximum allowed component temperatures
- Recommended reflow profile for the solder paste

A nitrogen atmosphere can generally improve solder joint quality, but is normally not necessary for soldering the available package lead finishes. For the lead-free process with higher reflow temperatures, a nitrogen atmosphere may reduce oxidation and improve the solder joint quality.

The temperature profile of a reflow process is divided into several phases, each with a special function. The single parameters are influenced by various factors, not only by the package. It is essential to follow the solder paste manufacturer's application notes. Additionally, most PCBs contain more than one package type and therefore the reflow profile has to be matched to all components' and materials' demands. We recommend measuring the solder joints' temperatures by thermocouples beneath the respective packages, taking into account that components with large thermal masses do not heat up as fast as lightweight components. The position and the surrounding of the package on the PCB, as well as the PCB thickness, can influence the solder joint temperature significantly.

[Figure 11](#) shows a general forced convection reflow profile for soldering SMD and THD packages, [Table 4](#) shows an example of the important parameters of such a solder profile for tin-lead and for lead-free alloys. The given data is an example, not a recommendation (for reference only).

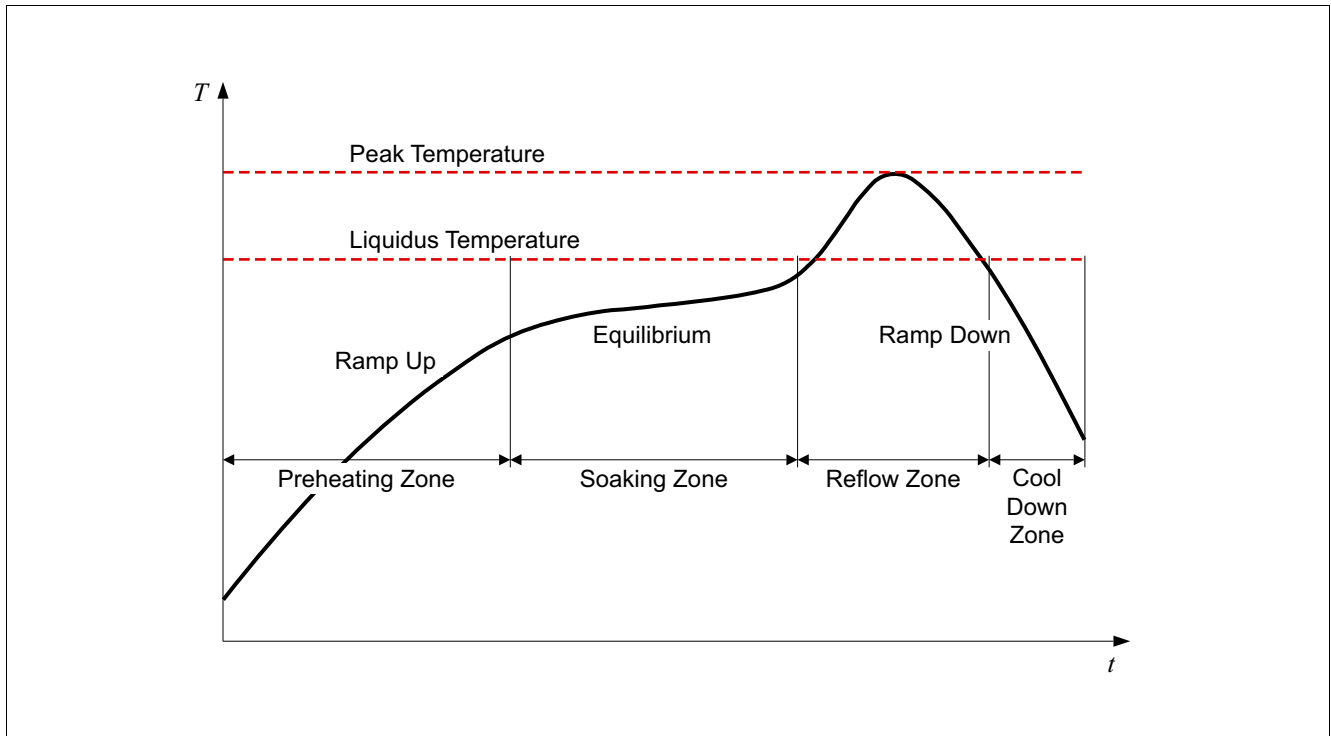

Figure 11 General Forced Convection Reflow Solder Profile

Table 4 Example of the Key Data of a Forced Convection Reflow Solder Profile

Parameter	Tin-lead Alloy (SnPb or SnPbAg)	Lead-free Alloy (SnAgCu)	Main Influences coming from ...
Preheating rate	2.5 K/s	2.5 K/s	Flux system (Solder paste)
Soaking temperature	140 - 170°C	140 - 170°C	Flux system (Solder paste)
Soaking time	80 s	80 s	Flux system (Solder paste)
Peak temperature	225°C	245°C	Alloy (Solder paste)
Reflow time over melting point (liquidus)	60 s	60 s	Alloy (Solder paste)
Cool down rate	2.5 K/s	2.5 K/s	

5.1.6 Processing of Moisture-Sensitive Components (MSL classification)

For moisture-sensitive packages, it is necessary to control the moisture content of the components.

For details, please refer to [Chapter 2.3](#).

Figure 12 shows a typical popcorn crack after soldering. The crack runs through the mold compound. This results in a direct path connecting the leadframe to the environment and weakens the component mechanically.

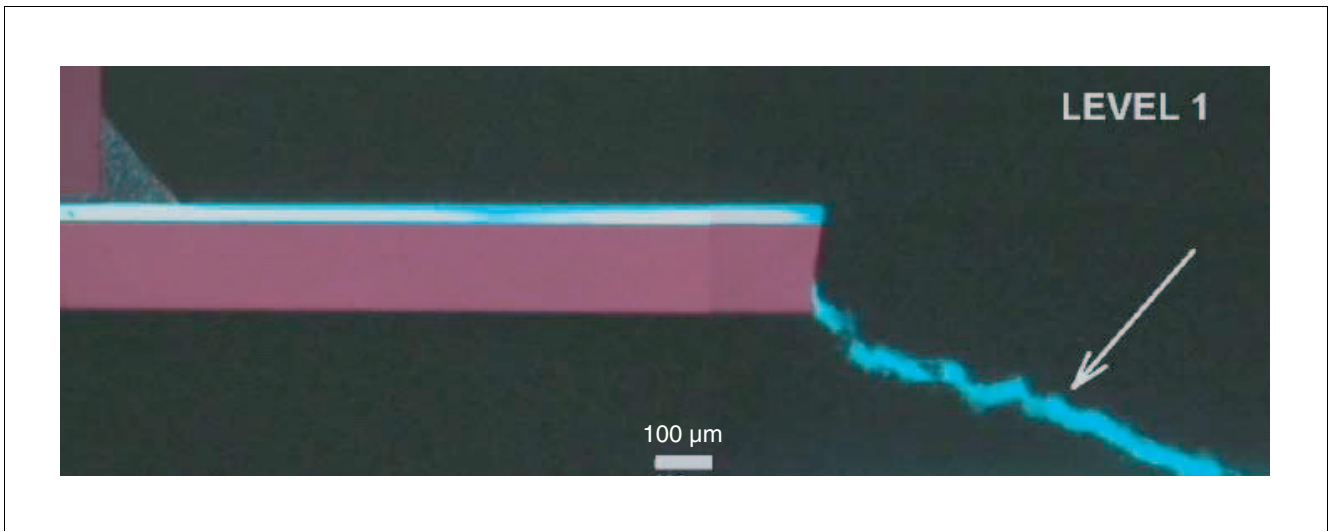

Figure 12 Popcorn Crack after Solder Shock

5.2 Process Flow for SMDs with Wave Soldering

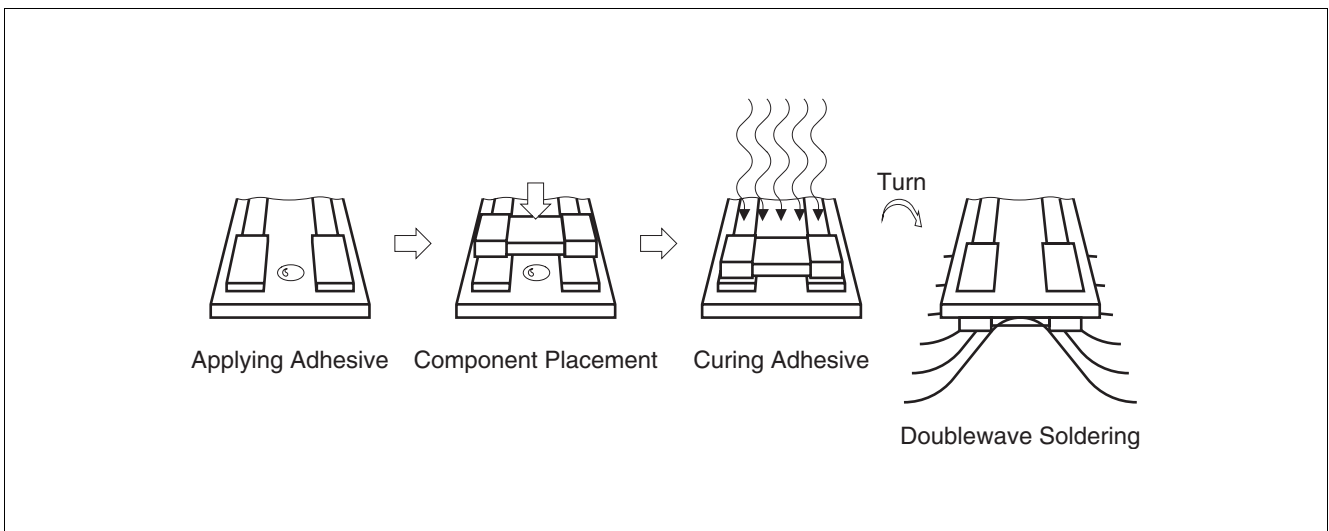

Figure 13 Attachment of SMDs Prior to Wave Soldering

When SMDs are to be wave soldered, they have to be attached to the PCB by glue. The sequence for this is as follows (**Figure 13**):

1. Setting of glue dots
2. Placement of SMDs
3. Curing of adhesive
4. Turning PCB
5. Double wave soldering of SMDs

For further information about wave soldering, please also refer to **Chapter 4.4.1**.

Almost all discrete semiconductors, but very few ICs, are suitable for wave soldering. The reasons for this are primarily:

- Not suitable for gluing (clearance from base to package too large)
- Technical problems during soldering (short circuits, interruptions)
- Excessively high temperature-shock stressing

The following types of components are generally not suitable for wave soldering:

- Area array components (e.g. BGA, LGA, PGA)
- Non-leaded components (e.g. QFN, DSON, TSLP)
- Components with exposed die pads or heatsinks on the bottom side of the component (e.g. TO263, ePad-DS0, ePad-QFP)

Fine-pitch components (≤ 0.65 mm) are not recommended for wave soldering due to increased risk of bridging adjacent leads.

Wave soldering SMT components requires special attention to the heat shock resistivity of the components and to the PCB design, which may differ in the suitable landing pad design for wave vs. reflow soldering (e.g. orientation towards transport direction, additional solder-thieves).

Please refer to the product or quality specifications for information about acceptable soldering methods and in particular the solder heat resistivity.

6 Combinations of Soldering Methods/Multiple Soldering

The following combinations (Figure 14) of soldering methods are examples for typical mass production:

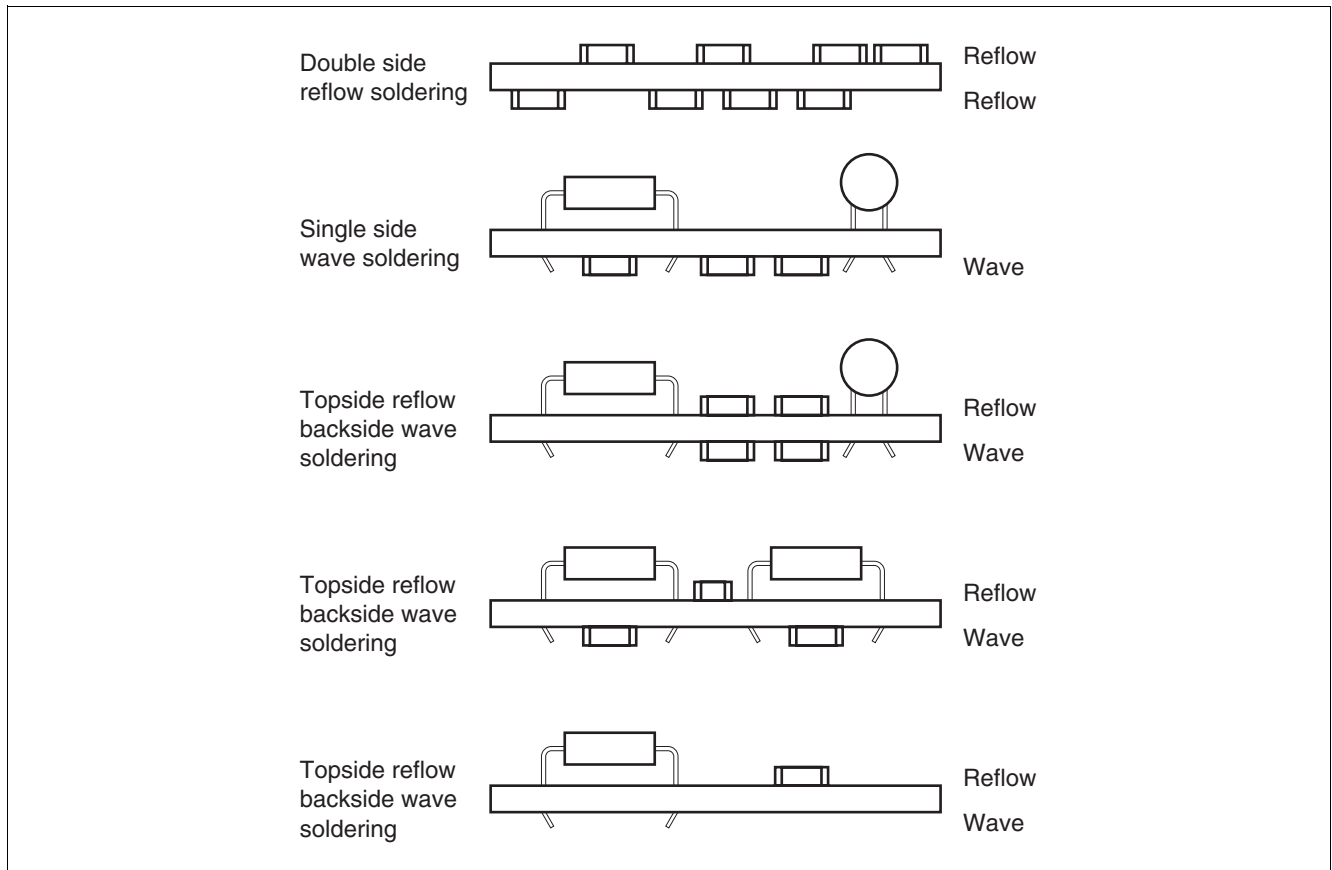

Figure 14 Various Combinations of Soldering Methods

Please keep in mind that all components have to be suitable for the applied soldering method. Components at one side may affect the reliability of components on the opposite side.

For every combination, special design rules (e.g. component distances) have to be considered.

Double-sided reflow soldering:

- Heavy components mounted to the topside (first reflow side) may fall off during reflow soldering of the backside (especially if there is heavy vibration during reflow)
- Components on the topside have to be suitable for being soldered two times at least (if classified by MSL, the components can be soldered three times)
- Excessive moisture soaking between first and second reflow may cause damage to moisture-sensitive devices on the topside. If the maximum storage time per MSL classification of any component already mounted prior to the second reflow soldering is exceeded, suitable measures to avoid moisture soaking have to be applied (e.g. storage in moisture-barrier bags or a dry cabinet). Alternatively, a dry bake of the entire PCB may be applied.

Topside reflow - backside (selective) wave soldering:

- Please take care that the SMDs used on the wave soldering side are suitable for this soldering method.
- Please be aware that an SMD mounted on the reflow soldering side may need a different board layout than the same SMD would if it were mounted on the wave soldering side.

Please also refer to the respective chapters for THDs and SMDs.

7 Cleaning

After the soldering process, flux residues can be found around the solder joints. If a “no-clean” solder paste has been used for solder paste printing, the flux residues usually do not have to be removed after the soldering process. However, if the solder joints have to be cleaned, the cleaning method (e.g. ultrasonic, spray, or vapor cleaning) and solution have to be selected by considering the packages to be cleaned, the flux used (rosin-based, water-soluble, etc.), and environmental and safety aspects. Removing/drying of even small residues of the cleaning solution should also be done very thoroughly. Contact the flux and solder paste manufacturer for recommended cleaning solutions. Note: For exposed die pad packages, LGAs, BGAs, or comparable packages, complete cleaning under the package body is not likely to be possible.

8 Inspection

After component placement:

A visual inspection after component placement can be done by microscope or AOI in order to check if the mounting was done completely or if severe misplacements occurred. The orientation of the component can also be checked.

After soldering:

A simple visual inspection of the solder joints can be done by optical microscope.

The only visible areas are leads and leadframe areas that extend beyond the package body.

Figure 15: shows a THD lead with ideal wetting. It has to be assured that a metallized via is filled properly. This can not be detected by visual inspection, but rather by X-ray and/or cross sections.

Figure 16 shows an SMD lead with ideal wetting. For SMDs, it may also be necessary to assess the joint quality under leads with X-ray and/or cross sections.

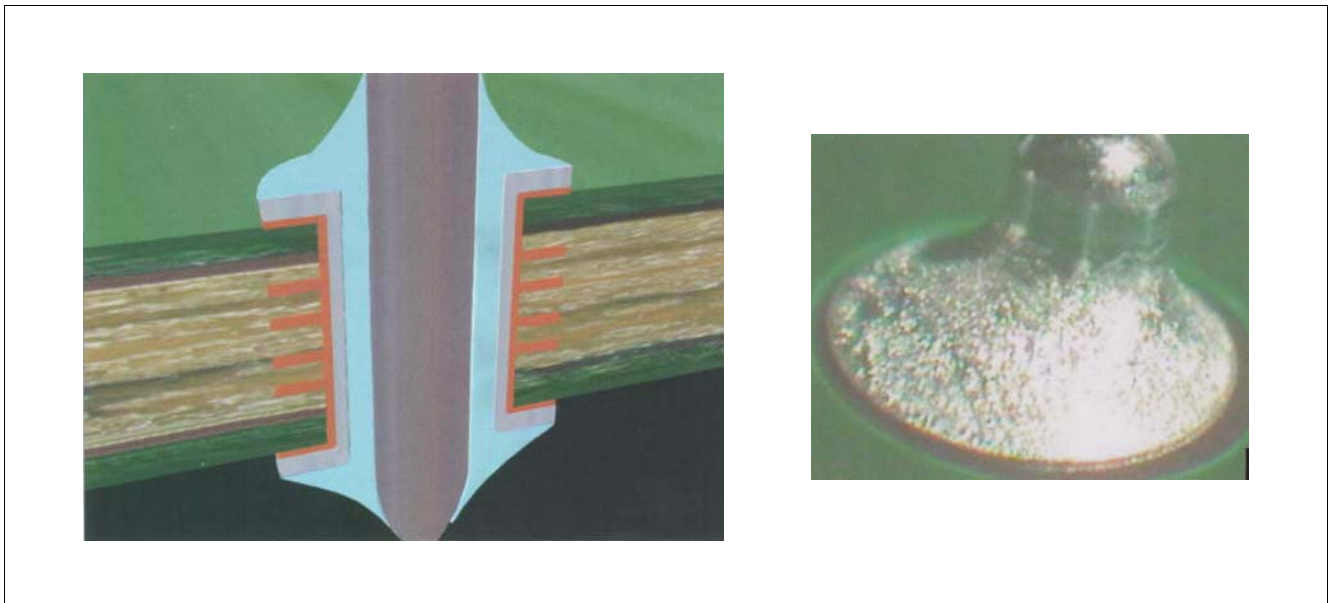

Figure 15 Example of an Ideally Wetted THD Lead (source: IPC610)

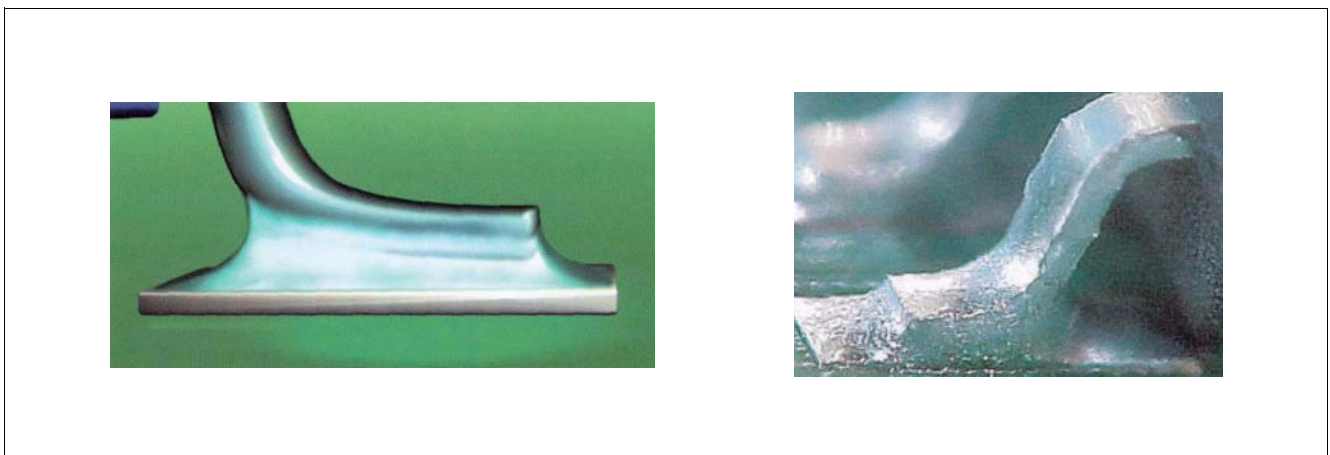

Figure 16 Example of an Ideally Wetted SMD Lead (source: IPC610)

If exposed die pads are soldered, the only reliable inspection method for the whole solder joint is by X-ray.

An automated visual inspection of the solder joints with conventional AOI systems is limited to the outer solder joints. Please keep in mind that the non-wetting of the punched or sawn lead tip is not a reject criterion. For packages with exposed pads, LGAs, BGAs, or comparable packages, the only reasonable methods for efficient inline control are to use AXI (Automatic X-ray Inspection) systems. AXI systems are available as 2D and 3D solutions. They usually consist of an X-ray camera and the hardware and software needed for inspection, controlling, analyzing and data transfer routines. These systems enable the user to reliably detect soldering defects such as poor soldering, bridging, voiding, and missing parts. For the acceptability of electronic assemblies, please refer also to the IPC-A-610 standard.

Cross-sectioning of a soldered package as well as dye penetrant analysis can serve as tools for sample monitoring only, because of their destructive character. Nonetheless, these analysis methods must be used during engineering of new products to get detailed information about the solder joint quality.

Lead-free solder joints look different from tin-lead (SnPb) solder joints. Tin-lead solder joints typically have a bright and shiny surface. Lead-free (SnAgCu) solder joints typically do not have a bright surface. Lead-free solder joints are often dull and grainy. These surface properties are caused by the irregular solidification of the solder, as the solder alloys used are not exactly eutectic, unlike 63Sn37Pb solder alloy. This means that SnAgCu-solders do not have a melting point but a melting range of several degrees. Although lead-free solder joints have this dull surface, this does not mean that lead-free joints are of lower quality or weaker than the SnPb joints. It is therefore necessary to teach the inspection staff how these lead-free joints should look, and/or to adjust optical inspection systems to handle lead-free solder joints.

9 Rework

If a defective component is observed after board assembly the device can be removed and replaced by a new one. Repair of single solder joints is generally possible but requires proper tools. Especially for fine pitch applications it may be difficult to use soldering irons.

The repair of single solder joints of BGAs or LGAs or the soldered exposed die pad is not recommended. For these type of packages special tools may be necessary.

In case of simple rework processes such as solder ironing and hot air gun soldering, please refer to [Chapter 4.4.3](#).

Whatever rework process is applied, the thermal limits of PCB and components (e.g. MSL information) have to be respected. A dry bake of the entire board may be necessary prior to rework. For details, please refer to [Chapter 2.3](#) and the international standard J-STD-033.

9.1 Tooling

The rework process is commonly done on special rework equipment. There are a lot of systems available on the market; for processing these packages, the equipment should meet the following requirements:

- *Heating:* Hot air heat transfer to the package and PCB is strongly recommended. Temperature and air flow for heating the device should be controlled. With freely programmable temperature profiles (e.g. by PC controller), it is possible to adapt the profiles to different package sizes and thermal masses. PCB preheating from beneath is recommended. Infrared heating can be applied, especially for preheating the PCB from the underside, but it should only augment the hot air flow from the upper side. Nitrogen can be used instead of air.
- *Vision system:* The bottom side of the package as well as the site on the PCB should be observable. For precise alignment of package to PCB, a split optic should be implemented. Microscope magnification and resolution should be appropriate for the pitch of the device.
- *Moving and additional tools:* The device should be relocatable on the whole PCB area. Placement accuracy is recommended to be better than $\pm 100 \mu\text{m}$. The system should have the capability of removing solder residues from PCB pads (special vacuum tools).

9.2 Device Removal

If a component is suspected to be defective and is to be sent back to the supplier, please note that during the removal of this component from the PCB, no further defects must be introduced to the device, because this may interfere with failure analysis at the supplier's facilities. The following recommendations are intended to reduce the chances of damaging a component during removal:

- *Moisture:* According to the moisture sensitivity level, the package may have to be dried before removal. If the maximum storage time out of the dry pack (see label on packing material) is exceeded after board assembly, the PCB should be dried according to the recommendations (see [Chapter 4.4](#)); otherwise, too much moisture may have been accumulated and damage may occur (popcorn effect).
- *Temperature profile:* During soldering, it should be assured that the package peak temperature is not higher and temperature ramps are not steeper than for the standard assembly reflow process (see [Chapter 4.4](#)).
- *Mechanics:* Be aware not to apply high mechanical forces for removal. Otherwise, failure analysis of the package can be impossible, and/or the PCB can be damaged. For large packages, pipettes can be used (implemented on most rework systems); for small packages, tweezers may be more practical.

If suspected components are underfilled or fragile, it is especially necessary to determine if they can be electrically tested at Infineon Technologies directly after desoldering, or if these components have to be re-balled or preconditioned prior to testing. Underfilling, for example, may interfere with contact, and it may be necessary to re-ball such desoldered components. In this case, or if safe removal of the suspected component is not possible or too risky, the whole PCB or the part of the PCB containing the defective component should be sent back.

9.3 Site Redressing

After removing the defective component, the pads on the PCB have to be cleaned to remove solder residues (and underfill residues if applicable).

This may be done by vacuum desoldering or wick. Some solvents may be necessary to clean the PCB of flux residues (and underfill residues if applicable).

Don't use steel brushes because steel residues can lead to bad solder joints. Before placing a new component on the site, solder paste should be applied to each PCB pad by printing (special micro stencil) or dispensing. No-clean solder paste is recommended.

9.4 Reassembly and Reflow

After preparing the site, the new package can be placed onto the PCB. Placement accuracy and placement force should be comparable to the automatic pick & place process. During soldering, it should be assured that the package peak temperature is not higher and temperature ramps are not steeper than for the standard assembly reflow process.

10 Coating of Assembled PCBs

In some applications, coatings are used to prevent damage due to external influences such as:

- Mechanical abrasion
- Vibration
- Shock
- Humidity
- Hand perspiration
- Chemicals and corrosive gases

These influences may cause:

- Electrical leakages due to humidity
- Corrosion that leads to degradation of conductor paths, solder joints, and any other metallized areas, and/or formation of electrical leakage paths. These can ultimately result in electrical shorts (electrical leakage) or open contacts
- Mechanical damage to conductor paths, solder joints, and components, leading to electrical failures

Coatings act as electrically isolating and impervious covers that adhere well to the various PCB materials. A wide variety of different coatings is available on the market, which differ in:

- Price
- Simple processability (spray, dip, casting, ...; curing; ...)
- Repairability
- Controllability
- Homogeneity

In any case, please be aware of the chemical, electrical, mechanical, and thermo-mechanical interaction between the coating and the PCB or the components. Coatings may affect component reliability.

11 List of References

IPC/EIA/JEDEC-J-STD-006 (Requirements for Electronic Grade Solder Alloys and Fluxed and Non-fluxed Solid Solders for Electronic Soldering Applications)

IPC/EIA/JEDEC-J-STD-001 (Requirements for Soldered Electrical and Electronic assemblies)

IPC A-610 (Acceptability of Electronic Assemblies)

IPC/JEDEC J-STD-033/-020 (Handling, Packing, Shipping and Use of Moisture/Reflow Sensitive Surface Mount devices)/(Moisture/reflow Sensitivity Classification for Nonhermetic Solid State Surface Mount Devices)

JESD22-B102 (Test Method for Solderability)

IEC 60068-2-58 (Test methods for solderability, resistance to dissolution of metallization and to soldering heat of surface mounting devices)

IPC 7351/7355 (Generic Requirements for Surface Mount Design and Land Pattern Standard)

www.infineon.com