

Recommendations for Assembly of Infineon TO Packages

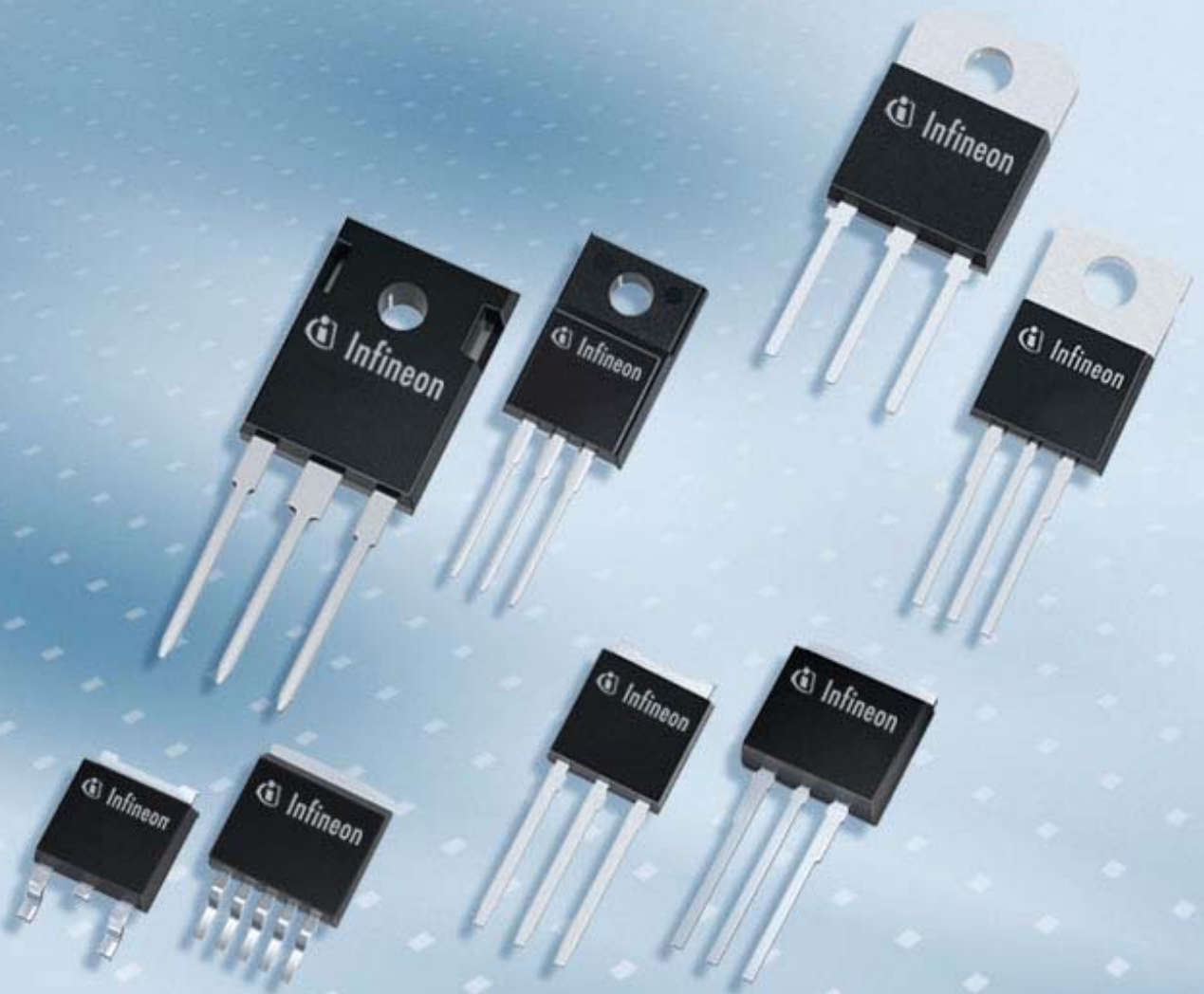

Never stop thinking

Edition 2008-03

**Published by
Infineon Technologies AG
81726 München, Germany**

**© 2008 Infineon Technologies AG
All Rights Reserved.**

Legal Disclaimer

The information given in this document shall in no event be regarded as a guarantee of conditions or characteristics. With respect to any examples or hints given herein, any typical values stated herein and/or any information regarding the application of the device, Infineon Technologies hereby disclaims any and all warranties and liabilities of any kind, including without limitation, warranties of non-infringement of intellectual property rights of any third party.

Information

For further information on technology, delivery terms and conditions and prices, please contact the nearest Infineon Technologies Office (www.infineon.com).

Warnings

Due to technical requirements, components may contain dangerous substances. For information on the types in question, please contact the nearest Infineon Technologies Office.

Infineon Technologies components may be used in life-support devices or systems only with the express written approval of Infineon Technologies, if a failure of such components can reasonably be expected to cause the failure of that life-support device or system or to affect the safety or effectiveness of that device or system. Life support devices or systems are intended to be implanted in the human body or to support and/or maintain and sustain and/or protect human life. If they fail, it is reasonable to assume that the health of the user or other persons may be endangered.

Table of Contents

1	Package Description and Thermal Performance	4
1.1	Package Description	4
1.2	Thermal Performance	6
1.2.1	Insulating Material	7
1.2.2	Thermal Grease	7
1.2.3	Mounting Torque	7
2	Package Handling	8
2.1	ESD Protective Measures	8
2.1.1	ESD Protective Measures in the Workplace	8
2.1.2	Equipment for Personal	8
2.1.3	Production Installations and Processing Tools	8
2.2	Packing of Components	9
2.3	Moisture-Sensitive Components (MSL Classification)	9
2.4	Storage and Transportation Conditions	10
2.5	Handling Damage and Contamination	11
2.6	Component Solderability	11
3	Pre-mounting Processes and Mounting Materials	12
3.1	Lead Cutting	12
3.2	Lead Bending	12
3.3	PCB Design	14
3.4	Pad Definition and Solder Mask Layer	14
3.5	PCB Pad Finishes	16
3.6	Heatsink Requirements	16
3.7	Attachment Holes for Heatsink Screw Mounting	16
4	Mounting of Through-hole TOs	17
4.1	Main Influences on Through-hole TO Assembly Quality	17
4.2	Placement of Through-hole TOs	17
4.3	Heatsink Mounting	17
4.3.1	Heatsink Screw Mounting	17
4.3.2	Heatsink Clip Mounting	20
4.4	Soldering of Through-hole TOs	21
4.4.1	Selective Wave Soldering of THDs	22
4.4.2	Other Soldering Techniques	23
4.4.3	Pin-in-Paste	23
4.4.4	Heatsink Mounting by Reflow Soldering	23
5	Mounting of Surface-mount TOs	24
5.1	Main Influences on Surface-mount TO Assembly Quality	24
5.2	Solder Paste	24
5.3	Solder Paste Application	24
5.4	Solder Paste Inspection	25
5.5	Component Placement	25
5.6	Reflow Soldering	26
6	Cleaning	29
7	Inspection	30
8	Rework	32
8.1	Device Removal	32
8.2	Site Redressing	32
8.3	Reassembly and Reflow	32
9	Coating of Assembled PCBs	33
9.1	List of References	33

1 Package Description and Thermal Performance

These notes are intended to cover topics related to processing Infineon's Plastic (Green) Transistor Single Outline Packages. Electrical and product-specific topics are covered by product data sheets and electrical application notes.

1.1 Package Description

Two general categories of TO packages are available.

Surface Mount TOs: The gullwing leads and heat slug or exposed die pads of Surface-Mount Devices (SMDs) can be mounted on one side of a Printed Circuit Board (PCB). Most commonly they are attached to the PCB by solder paste printing, pick&place and reflow soldering. **Figure 1** shows examples of Surface-Mount TO packages.

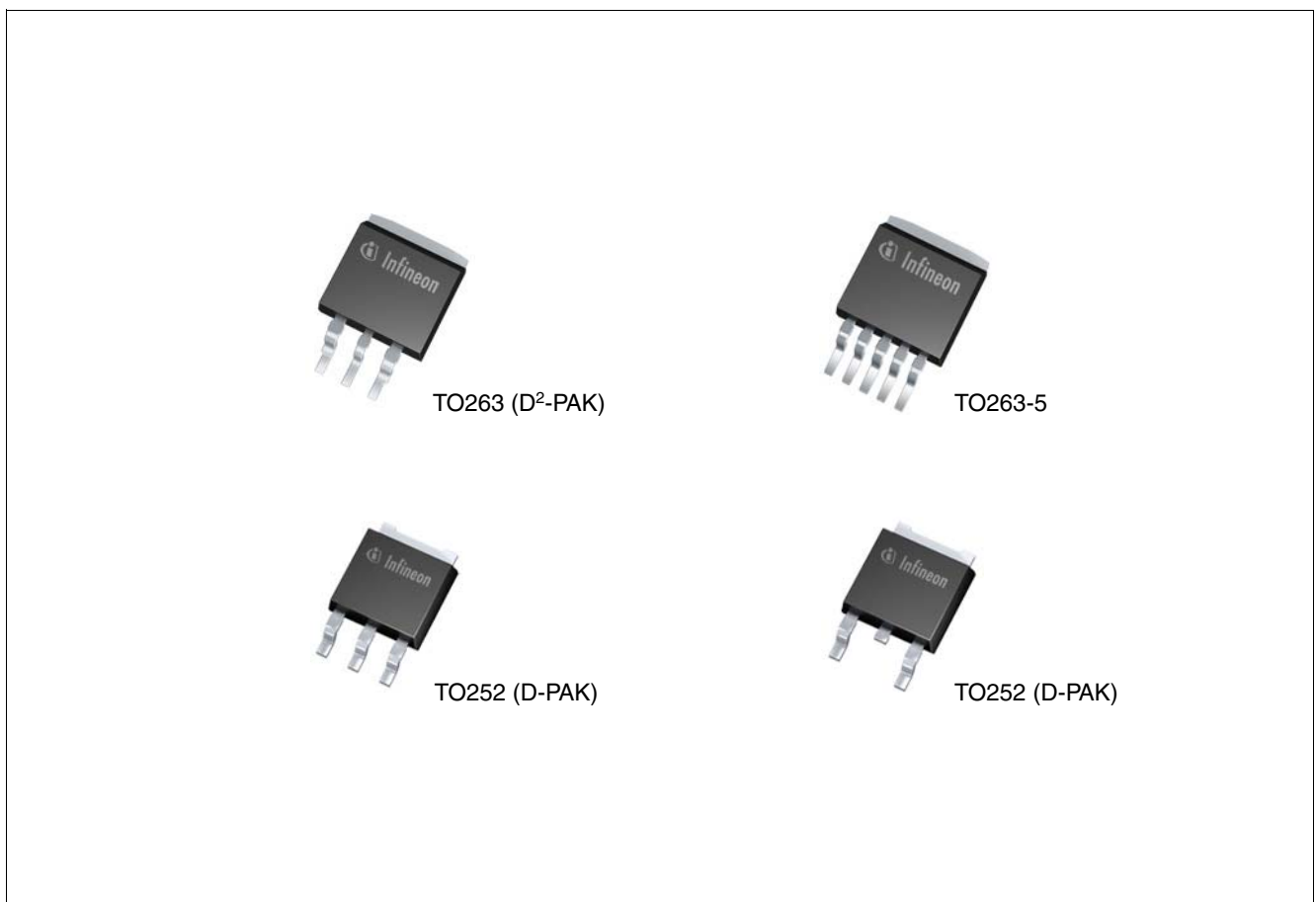

Figure 1 Examples of Surface-Mount TO Packages

Through-hole TOs: The leads of these Through-hole Devices (THDs) are longer and straight at the end, so that they can be inserted into drilled holes in PCBs and be attached by wave soldering, for example.

An extra heatsink can either be mounted on the heat slug or exposed die pad, or PCB pads can be used to dissipate the emerging heat. Depending on the process and technology, this requires an extra process before or after soldering the leads.

Figure 2 shows examples of Though-Hole TO packages.

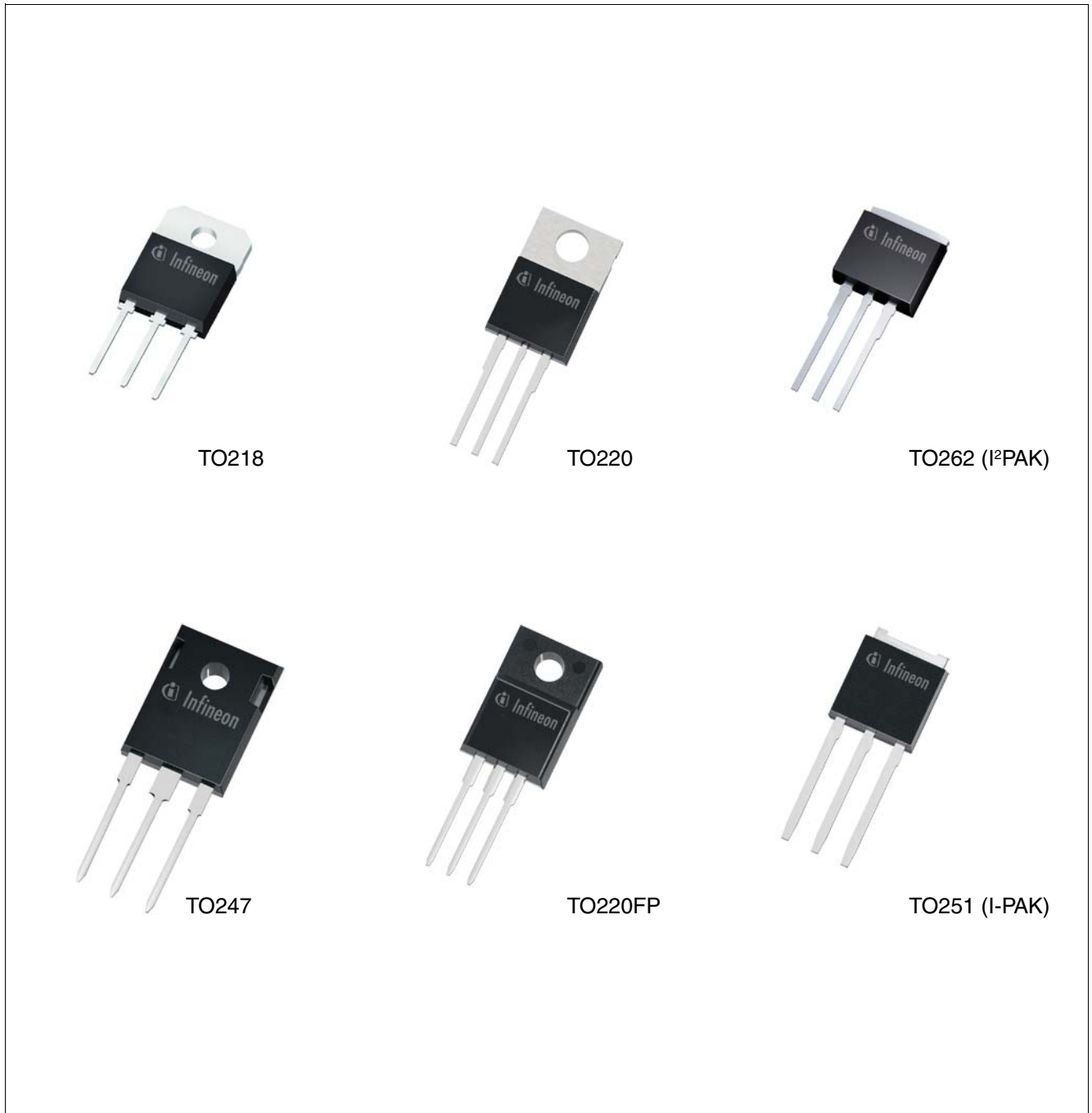

Figure 2 Examples of Through-hole TO Packages

1.2 Thermal Performance

The overall thermal performance of a package with a heatsink is characterized by a junction to ambient thermal resistance R_{thJA} . The R_{thJA} can be calculated with **Equation (1)** (see **Figure 3**).

$$R_{thJA} = R_{thJC} + R_{thCS} + R_{thS} + R_{thSA} \quad (1)$$

R_{thJA} thermal resistance junction - ambient (K/W)

R_{thJC} thermal resistance junction - case (K/W) - specified on the datasheet

R_{thCS} thermal resistance case - sink (K/W)

R_{thS} thermal resistance sink (K/W)

R_{thSA} thermal resistance sink - ambient (K/W)

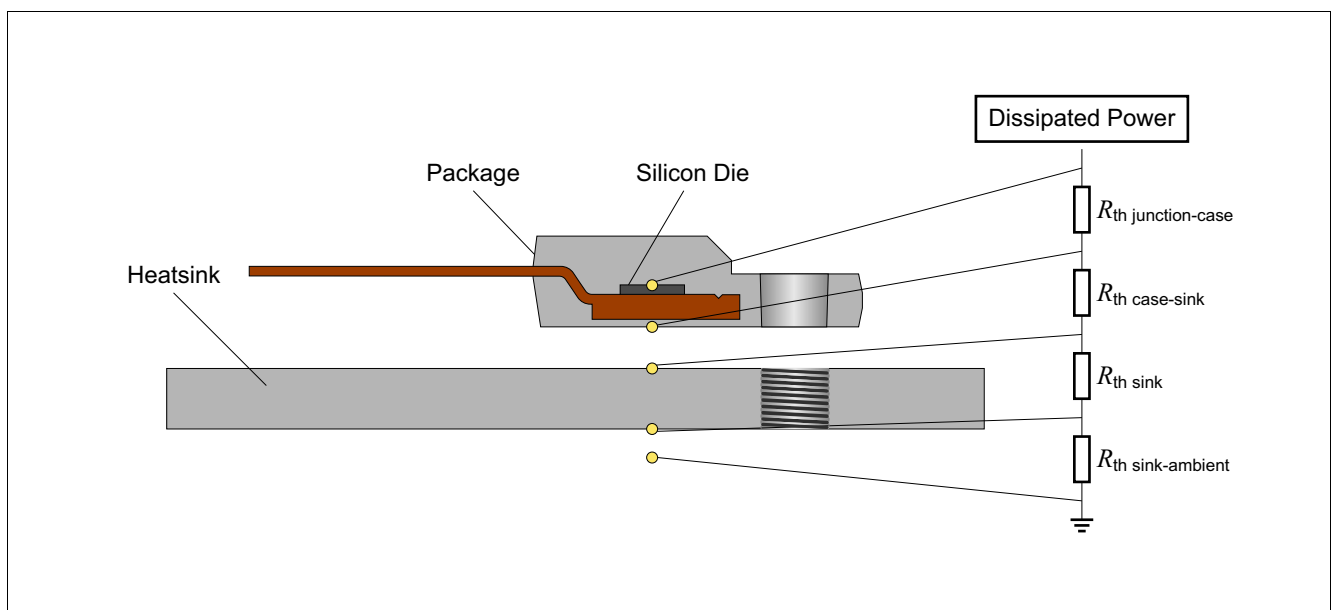

Figure 3 Thermal Model

When mounting the package on a heatsink, it is important to consider the interface resistance R_{thCS} . In an ideal case, R_{thCS} is zero. In real applications, there will be a small air gap because of these three factors:

- Package and heatsink are never perfectly smooth
- Package and heatsink are never perfectly flat
- Misalignment of package due to imperfect mounting

and thus R_{thCS} will always exceed zero.

For the insulated package TO220FP, thermal grease should be used to fill the air gap between the package and the heatsink. Measurements show that using thermal grease reduces the interface resistance by 1.2 - 1.5 K/W.

In many applications, the package must be electrically insulated from its mounting surface. The insulation has a comparatively high thermal resistance, which raises junction operating temperatures.

1.2.1 Insulating Material

Mica and silicone pads are well-known insulating materials that can be laid between the package and the heatsink. Mica is usually assembled with thermal grease on both sides. Mica is an effective thermal insulator and its cost is low. However, it is apt to be messy, and it can contaminate adjacent circuitry and dry out over time. Clean installation is possible with silicone pads. Reworking it is easy and inexpensive.

1.2.2 Thermal Grease

To determine the correct amount of grease to apply, several semiconductor samples and heatsinks should be assembled with different amounts of grease applied evenly to one side of each mating surface. When the amount is correct, a very small amount of grease should appear around the perimeter of each mating surface as the assembly is slowly torqued to the recommended value. Examination of a dismantled assembly should reveal even wetting across each mating surface.

1.2.3 Mounting Torque

Increasing the contact pressure between package and heatsink will maximize the contact area between the two surfaces. Increasing the mounting torque in the fastening screw, or using a clip with a high spring constant, will increase the contact areas and provide solid conduction heat-flow paths, which are more effective than conduction across an air gap.

Applying the proper mounting torque is the key factor in obtaining adequate pressure along the contact surfaces of the package and the heatsink, in order to minimize the contact thermal resistance. If mounting torque is too low, the contact thermal resistance increases due to bad thermal contact under insufficient contact pressure. If mounting torque is too high, the package head and mounting tab will deform so that the package may be lifted away from the heatsink, as shown in [Figure 4](#). This also increases the contact thermal resistance. Hence, appropriate mounting torque must be applied to produce minimal thermal resistance and avoid damaging the package or changing the device characteristics.

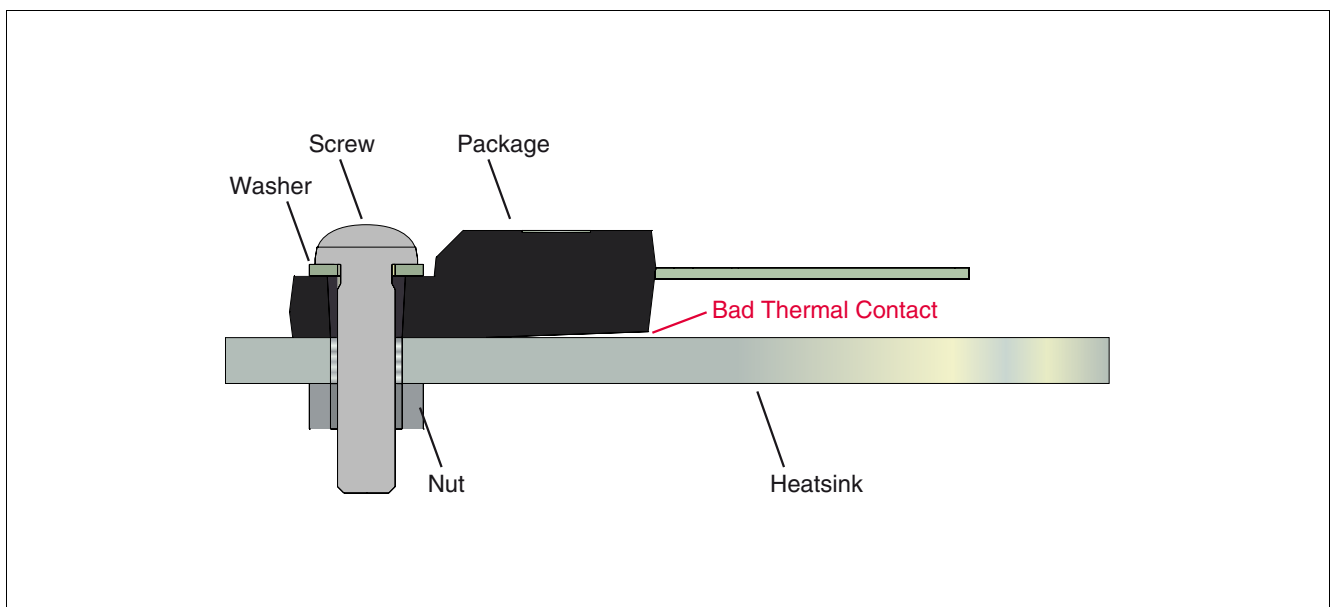

Figure 4 Example of a Bad Assembly in Screw Mounting

2 Package Handling

2.1 ESD Protective Measures

Semiconductors are normally Electrostatic Discharge Sensitive Devices (ESDS) requiring specific precautionary measures regarding handling and processing. Static discharges caused by human touch or by processing tools may cause high-current and/or high-voltage pulses, which may damage or even destroy sensitive semiconductor structures. On the other hand, Integrated Circuits (ICs) may also be charged by static during processing. If discharging takes place too quickly ("hard" discharge), it may cause peak loads and damages, too. ESD protective measures must therefore prevent contact with charged parts as well as charging of the ICs. Protective measures against ESD include proper procedures for the handling, processing, and the packing of ESDS. A few hints are provided below on handling and processing.

2.1.1 ESD Protective Measures in the Workplace

- Standard marking of ESD-protected areas
- Access controls, with wrist strap and footwear testers
- Air conditioning
- Dissipative and grounded floor
- Dissipative and grounded working and storage areas
- Dissipative chairs
- Ground bonding point for wrist strap
- Trolleys with dissipative surfaces and wheels
- Suitable shipping and storage containers
- No sources of electrostatic fields

2.1.2 Equipment for Personal

- Dissipative/conductive footwear or heel straps
- Suitable garments made of fabrics that do not generate excessive static electricity
- Wrist strap with safety resistor
- Volume conductive gloves or finger cots

2.1.3 Production Installations and Processing Tools

- Machine and tool parts made of dissipative or metallic materials
- No materials having thin insulating layers for sliding tracks
- All parts reliably connected to ground potential
- No potential difference between individual machine and tool parts
- No sources of electrostatic fields

Detailed information on ESD protective measures may be obtained from the ESD Specialist through Area Sales Offices. Our recommendations are based on the internationally applicable standards IEC 61340-5-1 and ANSI/ESD S2020.

2.2 Packing of Components

Please refer to product and package specifications (on Infineon’s homepage) and our sales department to get information about what packaging is available for a given product.

Generally the following list of standards dealing with packing should be considered if applicable for a given package and packing:

IFX packs according to the IEC 60286-* series

- IEC 60286-3 Packaging of components for automatic handling - Part 3:
Packaging of surface mount components on continuous tapes
- IEC 60286-4 Packaging of components for automatic handling - Part 4:
Stick magazines for dual-in-line packages
- IEC 60286-5 Packaging of components for automatic handling - Part 5:
Matrix trays

Moisture-sensitive Surface Mount Devices are packed according to IPC/JEDEC J-STD-033*:
Handling, Packing, Shipping and Use of Moisture/Reflow Sensitive Surface Mount Devices

For detailed packing drawings please refer to the package specific information given in the internet (<http://www.infineon.com/cms/en/product/technology/packages/>) or the product data sheet.

Other references:

- ANSI/EIA-481-* Standards Proposal No. 5048, Proposed Revision of ANSI/EIA-481-B 8 mm through 200 mm Embossed Carrier Taping and 8 mm & 12 mm Punched Carrier Taping of Surface Mount Components for Automatic Handling (if approved, to be published as ANSI/EIA-481-C)
- EIA-783 Guideline Orientation Standard for Multi-Connection Package (Design Rules for Tape and Reel Orientation)

2.3 Moisture-Sensitive Components (MSL Classification)

For moisture-sensitive packages, it is necessary to control the moisture content of the components. The penetration of moisture into the package molding compound is generally caused by exposure to the ambient air. In many cases, moisture absorption leads to moisture concentrations in the component that are high enough to damage the package during the reflow process. Thus it is necessary to dry moisture-sensitive components, to seal them in a moisture-resistant bag, and to remove them from the bag only immediately prior to assembly to the PCB. The permissible time (from opening the moisture-barrier bag until the final soldering process) during which a component can remain outside the moisture barrier bag is a measure of the sensitivity of the component to ambient humidity (Moisture-Sensitivity Level, MSL). The most commonly applied standard, IPC/JEDEC J-STD-033*, defines eight different MSLs (see [Table 1](#)). Please refer to the “Moisture Sensitivity Caution Label” on the packing material, which contains information about the MSLs of our products. IPC/JEDEC-J-STD-20 specifies the maximum reflow temperature that must not be exceeded during board assembly at the customer’s facility.

Table 1 Moisture Sensitivity Levels (according to IPC/JEDEC J-STD-033*)

Level	Floor Life (out of bag)	
	Time	Conditions
1	Unlimited	≤30°C / 85% RH
2	1 year	≤30°C / 60% RH
2a	4 weeks	≤30°C / 60% RH
3	168 hours	≤30°C / 60% RH
4	72 hours	≤30°C / 60% RH
5	48 hours	≤30°C / 60% RH
5a	24 hours	≤30°C / 60% RH
6	Mandatory bake before use. After bake, must be reflowed within the time limit specified on the label.	≤30°C / 60% RH

If moisture-sensitive components have been exposed to ambient air for longer than the time specified in their MSL, or the humidity indicator card indicates too much moisture after opening the dry package, the packages have to be baked prior to the assembly process. Please refer to IPC/JEDEC J-STD-033* for details. Baking a package too often can cause solderability problems due to oxidation and/or intermetallic growth. Notice that packing material may not be able to withstand the baking temperature. Please refer to imprints/labels on the packing for maximum temperature.

Two moisture sensitivity levels can be given depending on the reflow peak temperature. For lower reflow peak temperature of tin-lead devices might withstand a longer soaking time, as for higher reflow peak temperature of lead-free the MSL might be derated.

2.4 Storage and Transportation Conditions

Improper transportation and unsuitable storage of components can lead to a number of problems during subsequent processing, such as poor solderability, delamination, and package cracking effects.

These relevant standards should be taken into account as appropriate:

- IEC 60721-3-0 Classification of environmental conditions: Part 3:
Classification of groups of environmental parameters and their severities; introduction
- IEC 60721-3-1 Classification of environmental conditions: Part 3:
Classification of groups of environmental parameters and their severities; Section 1: Storage
- IEC 60721-3-2 Classification of environmental conditions: Part 3:
Classification of groups of environmental parameters and their severities; Section 2: Transportation
- IEC 61760-2 Surface mounting technology - Part 2:
Transportation and storage conditions of surface mounting devices (SMD) - Application guide
- IEC 62258-3 Semiconductor Die Products - Part 3:
Recommendations for good practice in handling, packing and storage
- ISO 14644-1 Clean rooms and associated controlled environments Part 1:
Classification of airborne particulates

Table 2 General Storage Conditions - Overview

Product	Condition for Storing
Wafer/Die	N2 or MBB ¹⁾ (IEC 62258-3)
Component - moisture sensitive	MBB (JEDEC J-STD-033*)
Component - not moisture sensitive	1K2 (IEC 60721-3-1)

1) MBB = Moisture Barrier Bag

Maximum storage time

The conditions to be complied with in order to ensure problem-free processing of active and passive components are described in standard IEC 61760-2.

Internet links to standards institutes

[American National Standards Institute \(ANSI\)](#)

[Electronics Industries Alliance \(EIA\)](#)

[Association Connecting Electronics Industries \(IPC\)](#)

2.5 Handling Damage and Contamination

Any mechanical damage during automatic or manual handling of components (in or out of the component packing) that may harm package leads and/or body has to be avoided. In particular, unintentional bending of leads may cause a loosening in the package body which can result in electrical malfunction.

Generally, the components in the packing are ready to use. Intentional cutting and/or bending are sometimes needed to prepare THDs prior to mounting (insertion). In this case, the cutting and bending instructions in [Chapter 3.1](#) and [Chapter 3.2](#) must be considered.

Along with other factors, any contamination applied to a component or packing may cause:

- Solderability problems
- Corrosion
- Electrical shorts (due to conductive particles)

2.6 Component Solderability

The final plating or solder depots/balls of most semiconductor packages are sufficiently thick and wettable to assure good solderability, even after a long storage time. Note that the cut edges of the pins should be ignored in any assessment of solderability. Suitable methods for the assessment of solderability can be derived from JESD22B 102 or IEC6068-2-58.

Components may be post-mold-plated with SnPb or pure Sn, or preplated with noble metals on a Ni carrier (e.g. NiAu, NiPdAu). Tin-plated and preplated components are compatible with both SnPb and Pb-free soldering. Please refer to the product data sheet and the notes about Green products on the IFX homepage if another combination must be used. Please ask your local sales, application or quality engineer for further support.

3 Pre-mounting Processes and Mounting Materials

3.1 Lead Cutting

The leads of THDs can be cut before mounting or after mounting and soldering.

When cutting after soldering, the leads are attached by the solder joint. Severe mechanical mishandling during cutting process could cause solder joint failure, but generally does not harm the component body.

When cutting prior to mounting, the leads have to be fixed by a clamp that should be similar to a clamp used for lead bending (please refer to [Chapter 3.2](#))

3.2 Lead Bending

To insert the terminals of THDs in the holes of the PCB, the terminals may have to be bent to a certain pitch of the solder pads.

The following guidelines should be observed:

- Some packages have wider leads near the package body. In this case, the bending distance has to be no less than the distance between the narrow lead part to the package body ([Figure 5](#)).
- In other cases, the minimum distance between package body and bending should be 2.5 mm ([Figure 6a & Figure 6b](#)). The leads must not be bent directly at the edge of the package. ([Figure 6c](#)).
- The minimum bend radius must be 0.5 mm
- For bending, a clamping tool should be used that ensures that mechanical forces such as pulling and shearing do not occur between the leads and the package body. The part of the lead between the point of bending and the package must be relieved of tensile stress during the bending process ([Figure 7a & Figure 7b](#)). Therefore, it is necessary to avoid slippage due to weak clamping, or weakening of the lead due to overly strong clamping.
- A properly designed clamping tool helps to ensure that the shape of the bends are consistently reproducible.
- The tensile strength of the leads from the clamping to the point where the bending force is applied should not be exceeded by using too much force. This maximum force is mainly dependent on the cross-sectional area of the lead. A typical maximum force is 20 N.
- Bending the leads parallel to the lead plane is not allowed ([Figure 7c](#)).
- Bending the leads manually is acceptable when the guidelines above are followed.

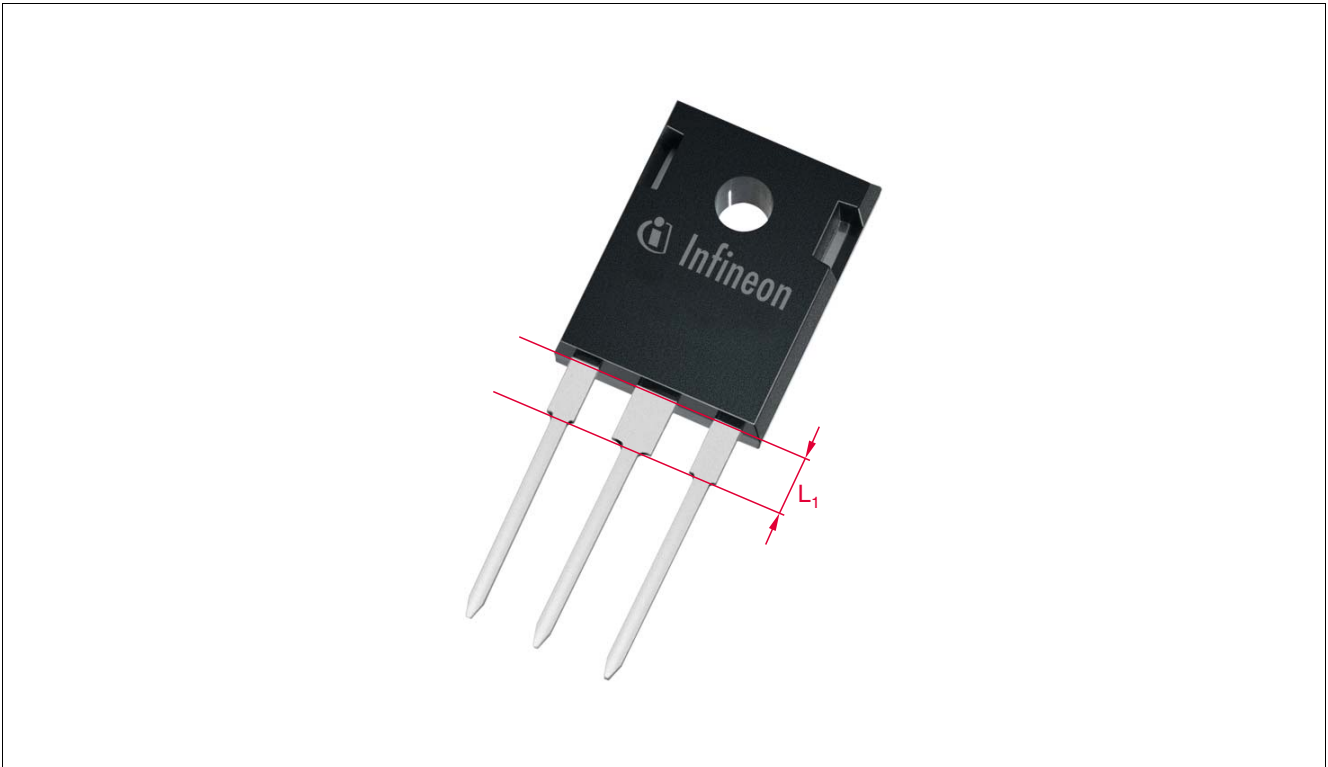

Figure 5 Minimum cutting and bending distance given by the distance between package body and narrow leads. L_1 depends on the specific package and can be seen in the package drawings.

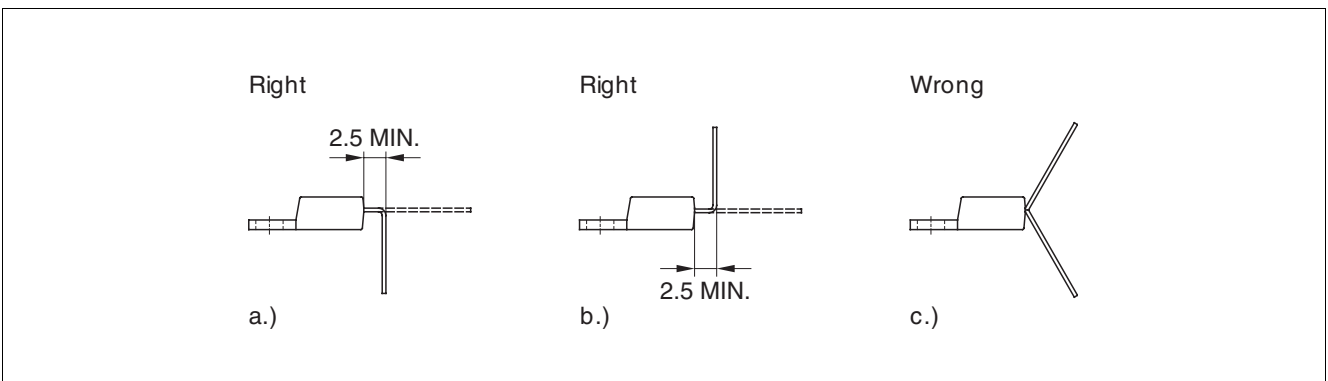

Figure 6 Examples of Bent Leads of THT Devices

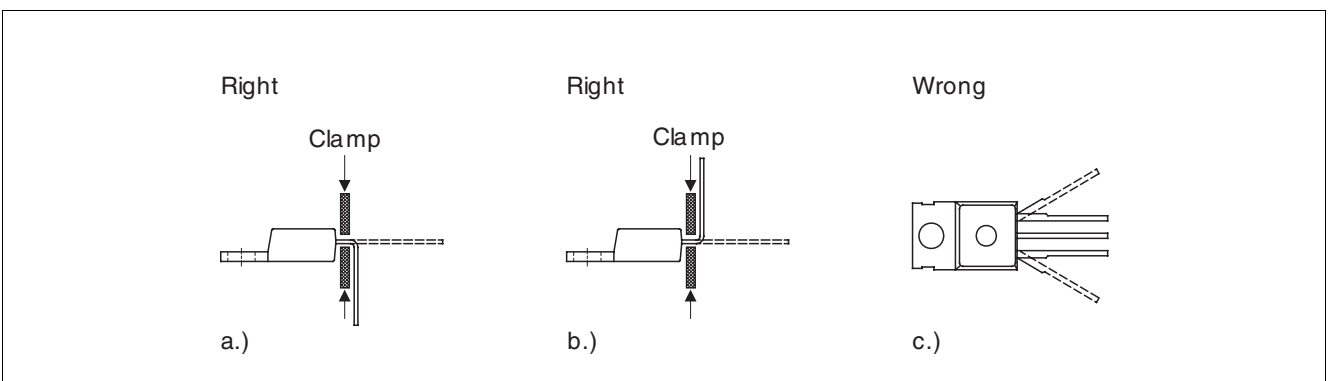

Figure 7 Examples of Lead Bending

3.3 PCB Design

For information about the PCB pad design for the leads and especially the exposed die pad, please refer to the specifications for the Footprint of the respective package. This can be found in the Infineon Internet under - >products ->packages -> respective package (e.g. PG-TO-252-3-1) -> footprint.

3.4 Pad Definition and Solder Mask Layer

Generally, two basic types of solder pads are used.

- “Solder mask defined” (SMD) pad (**Figure 8**): The copper metal pad is larger than the solder mask opening above this pad. Thus the pad area is defined by the opening in the solder mask.

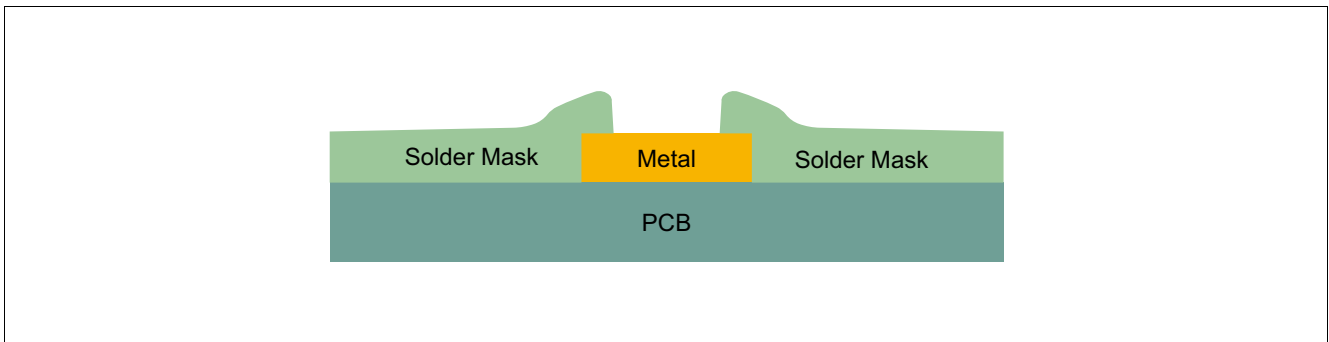

Figure 8 SMD Pad

- “Non-Solder Mask Defined” (NSMD) pad (**Figure 9**): Around each copper metal pad there is solder mask clearance. Dimensions and tolerances of the solder mask clearance have to be specified to ensure that the solder pad is not overlapped by the solder mask. Depending on the PCB manufacturer’s tolerances, 75 µm is a widely used value.

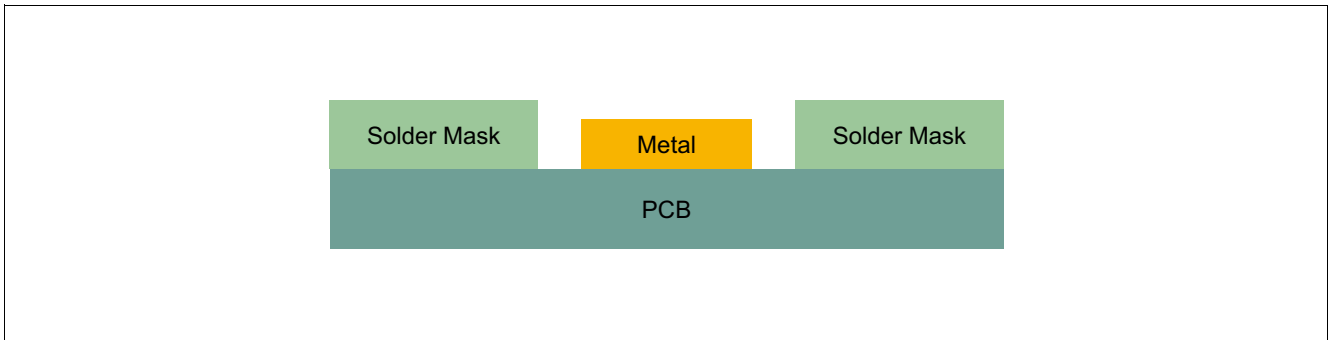

Figure 9 NSMD Pad

Solder masking reduces the risk of solder bridging. Therefore it should be applied between all copper pads that are electrically separated.

Solder masking can also be used to divide big copper areas in smaller wettable areas. This often improves processability and results in balanced solder joints.

We recommend SMD pads for soldering the exposed die pad. SMD pads offer a better heat distribution without violating the recommended dimensions for the wettable surface. For power-consuming and heat-dissipating products in TO packages, it is necessary to have wide conductor paths or even big metal areas, which can be easily structured by solder masking to get a certain size for the wettable surface.

When using other mounting methods for exposed die pads of TO packages, solder masking is not usually necessary.

Generally it is possible to lay out the board pad 1:1 to the exposed die pad.

Pre-mounting Processes and Mounting Materials

If the exposed die pad protrudes one or more sides of the package body, it can be helpful to increase the board pad size slightly in this area to get a better self-centering of the component during reflow soldering.

If the exposed die pad is fully hidden under the package body or even surrounded by peripheral pads, it can be helpful to decrease the board pad size to get more space for routing and vias for these peripheral pads if necessary.

To connect the exposed die pad thermally and electrically directly to inner and/or bottom copper planes of the board, plated through-hole vias are used. They help to distribute the heat coming from the chip over the package die pad and the solder joint to the thermal pad on the board.

A typical hole diameter for such thermal vias is 0.2 to 0.4 mm. This diameter and the number of vias in the thermal pad depend on the thermal requirements of the end product, the power consumption of the product, the application, and the construction of the PCB. However, an array of thermal vias with pitch 1.0 - 1.2 mm can be a reasonable starting point for most products/applications for further optimization. Thermal and electrical analysis and/or testing are recommended to determine the minimum number needed.

If the vias remain open during board manufacturing, solder may flow into the vias during board assembly ("solder wicking"). This results in lower stand-off (which is mostly controlled by the solder volume between the package die pad and thermal pad on the PCB), and/or solder protruding from the other side of the board, which may interfere with a second solder paste printing process on this opposite board side. To prevent solder beading, a wettable surface surrounding these vias should be provided to act as a buffer for the surplus solder.

Under certain conditions, open vias could have the effect of large voids in the "thermal" solder joint under the die pad, but in general the open vias serve as venting holes for gas in the solder joint.

If necessary, the solder wicking can be avoided by plugging (filling with epoxy) and overplating the vias. Having very small vias, so-called microvias (approx. 100 μm), it is generally sufficient to overplate the via and get a filling by copper. In both cases it is necessary to specify a planar filling. Yet flat dents tend to increased voiding. They serve as traps for voids forming during reflow soldering.

Another method is so-called tenting. The vias in this case are covered with solder mask (e.g. dry-film solder mask). Via tenting shall be done from top, because with via tenting only from bottom side voiding rate is significantly higher. Combined with an intelligent soldermask layout for the thermal pad this method leads to good processability and balanced solder joints.

If it is not necessary to have a direct connection from the solder pad under the exposed die pad to inner layers of the PCB, it is recommended to place the vias near the package and cover them with solder mask.

3.5 PCB Pad Finishes

The solder pads have to be easy for the solder paste to wet. In general, all finishes are well proven for SMT assembly, but for fine pitch applications, the quality of the plating/finish is especially important. Because of the uneven surface of the Hot Air Solder Leveling (HASL) finish, lead-free or lead-containing HASL finishes are less preferred for assembly (especially for pitch < 0.65 mm) compared to completely “flat” platings such as Copper Organic Solderability Preservative (Cu-OSP) or electroless Sn or NiAu.

From the package point-of-view, it is not possible to give a definite recommendation for PCB pad finish. It also depends strongly on board design, pad geometry, all the components on the board, and process conditions.

Table 3 Typical PCB Pad Finishes

Finish	Typ. Layer Thickness [µm]	Properties	Concerns
HASL (SnAg) (Hot Air Solder Leveling)	> 5	cheap, widely used, well-known in fabrication	uneven surface, formation of humps, flatness of single pads has to be good for fine-pitch applications
Electroless Tin	0.3 - 1.2	solder joint consists only of copper and solder, no further metal is added to the solder joint	long-term stability of protection may be a concern, baking of PCB may be critical
Electroless Silver	0.2 - 0.5	solder joint consists only of copper and solder, no further metal is added to the solder joint	long-term stability of protection may be a concern, baking of PCB may be critical
Electroless Ni / Immersion Au (ENIG)	3 - 7 / 0.05 - 0.15	good solderability protection, high shear-force values	expensive, concerns about brittle solder joints
Galvanic Ni/Au	> 3 / 0.1 - 2	only for thicker layers, typically used for connectors	expensive, not recommended for solder pads
OSP (Organic Solderability Preservatives)	Typical 1	cheap, simple, fast and automated fabrication	must be handled carefully to avoid damaging the OSP; not as good long-term stability as other coatings; for double-sided reflow, only suitable with inert gas reflow

3.6 Heatsink Requirements

The contact area of the package and the heatsink (separate or PCB) must be free of any particles and damage as well as any other contamination. The following surface conditions are recommended:

Heatsink roughness: RZ ≤ 10 µm

Heatsink flatness: ≤ 10 µm (reference length 15 mm)

3.7 Attachment Holes for Heatsink Screw Mounting

Drill holes should be as small as possible. Using oversized drill holes will reduce the effectiveness of the heatsink. The flatness and effectiveness of the heatsink (separate or PCB) is also reduced by intrusions and/or burrs around the hole. These are caused by the punching or drilling process and should be less than the specified heatsink roughness and flatness.

If intrusions or large drill holes are unavoidable, a properly sized square washer should be used to get a good and flat contact between heatsink and package.

4 Mounting of Through-hole TOs

4.1 Main Influences on Through-hole TO Assembly Quality

The following factors have to be taken into account to achieve the best assembly quality for a given application:

- Insulating material (e.g. washer or spacer)
- Screws
- Thermal grease
- Mounting torque
- PCB and heatsink (please refer to [Chapter 3](#))
- Attachment holes for heatsink screw mounting (please refer to [Chapter 3](#))
- Soldering method / soldering profile
- Solderability of package

4.2 Placement of Through-hole TOs

The insertion of THDs is either done with special automatic equipment or manually. Special care has to be taken during this insertion to avoid deformation or violent bending. The diameter of the drill holes in the PCB must be take into account the tolerances of component leads, drill-hole positions, and placement accuracy.

Normally after insertion, the leads are slightly bent to fasten the component to the PCB until soldering. Please take care that this does not lead to stress that can cause defects at the interconnect between leads and package body.

4.3 Heatsink Mounting

For special packages with high power dissipation, the heatsink can be mounted before or after soldering of the leads.

4.3.1 Heatsink Screw Mounting

Screw mounting is a traditional assembly method accomplished by fastening a screw, nut and washer together.

- Self-tapping screws should not be used.
- A rectangular washer should be inserted between the screw head and the mounting tab. Care must be taken to ensure that the washer does not damage the plastic body of the package during the mounting process.

The screw should be tightened properly to ensure that the package makes good contact with the heatsink.

[Figure 10](#) illustrates proper mounting methods for a TO220 and a TO220FP.

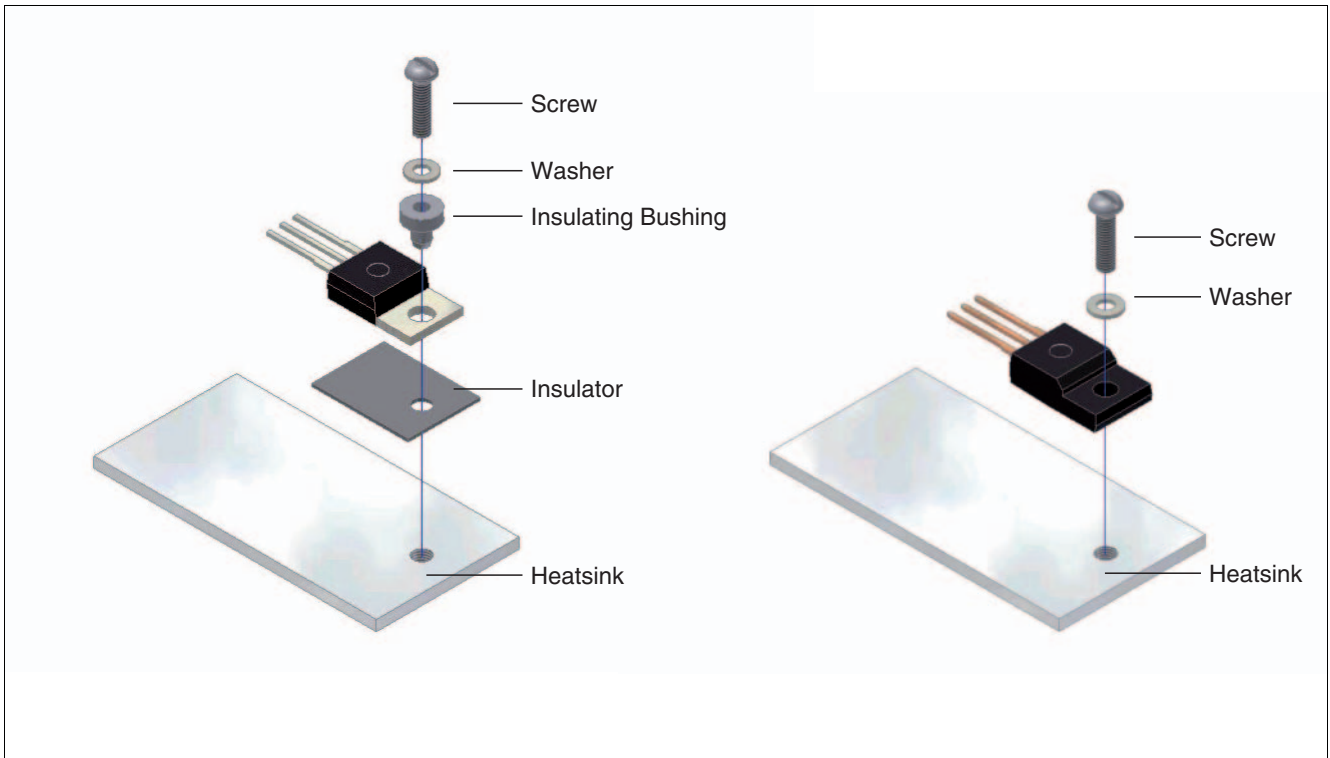

Figure 10 Screw-mounted TO220 (left) and TO220FP (right)

Typical and maximum mounting torque values are listed in Table 4.

Table 4 Typical and Maximum Mounting Torque Values

Package	Typ. Torque [Nm]	Max. Torque [Nm]	Comment
PG-TO220	0.6	0.7	Screw M3
PG-TO220 FullPAK	0.5	0.7	Screw M2.5
PG-TO218	0.6	0.7	Screw M3/ M4
PG-TO247	0.5	0.7	Screw M3/ M4

Examples of improper mounting:

Example (1):

CSAM (C-Scanning Acoustic Microscopy) Delamination of moulding compound to die paddle at package head caused by external mechanical stress from improper mounting.

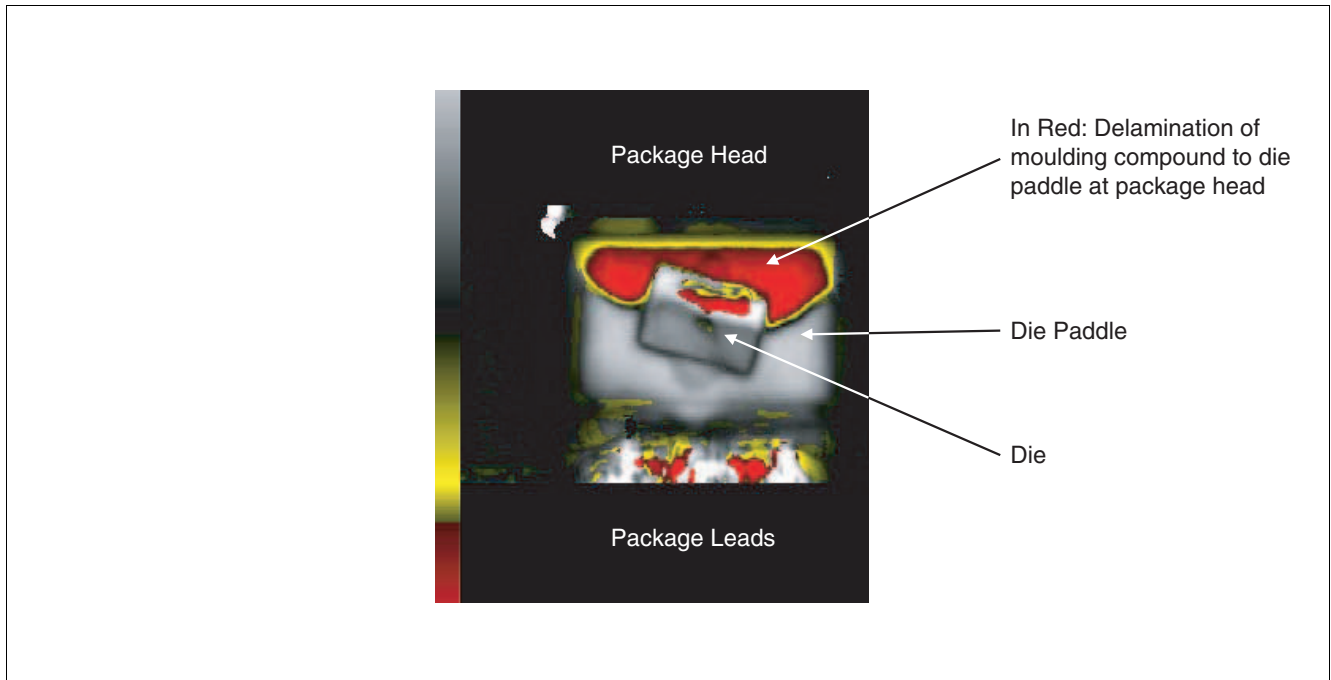

Figure 11 Delamination of Moulding Compound to Die Paddle at Package Head (TO220)

Example (2):

Cross-section of vertical die crack caused by external mechanical stress due to improper mounting. The result has been verified by die penetration test.

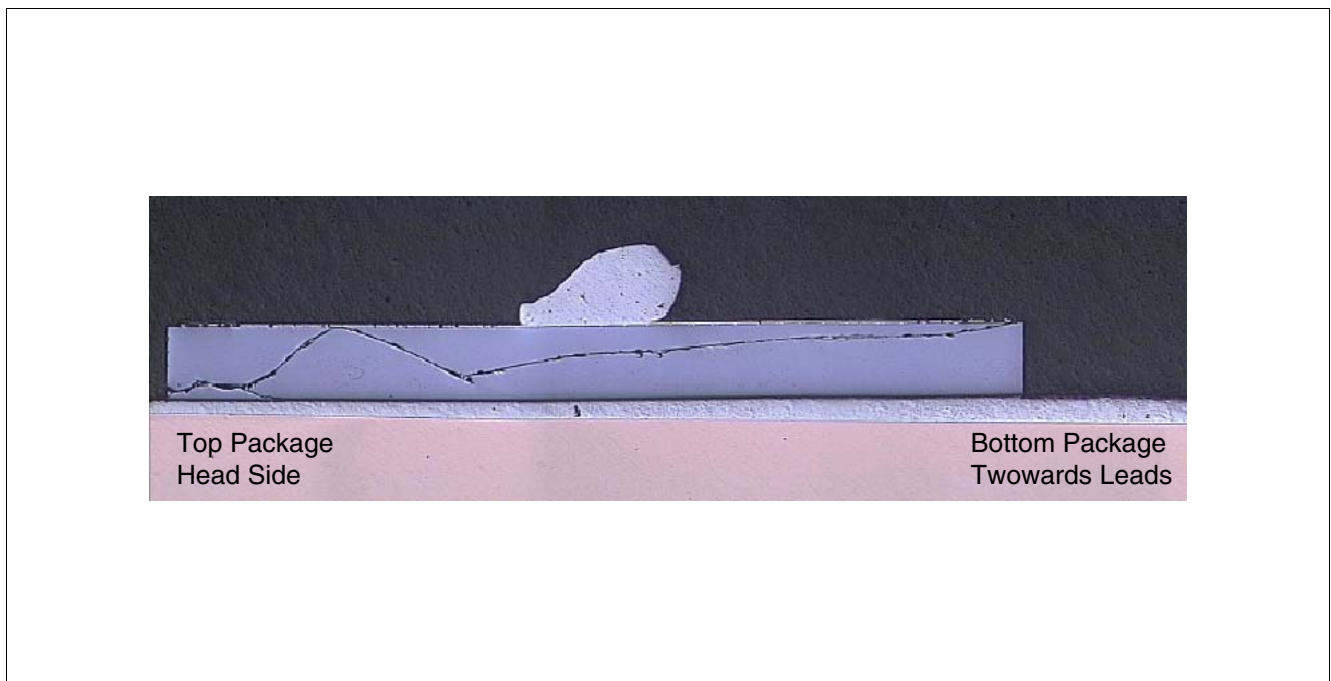

Figure 12 Vertical Die Crack Due to External Mechanical Stress (TO220)

Example (3):

Impression on the package surface due to overtightening (see [Figure 13](#)).

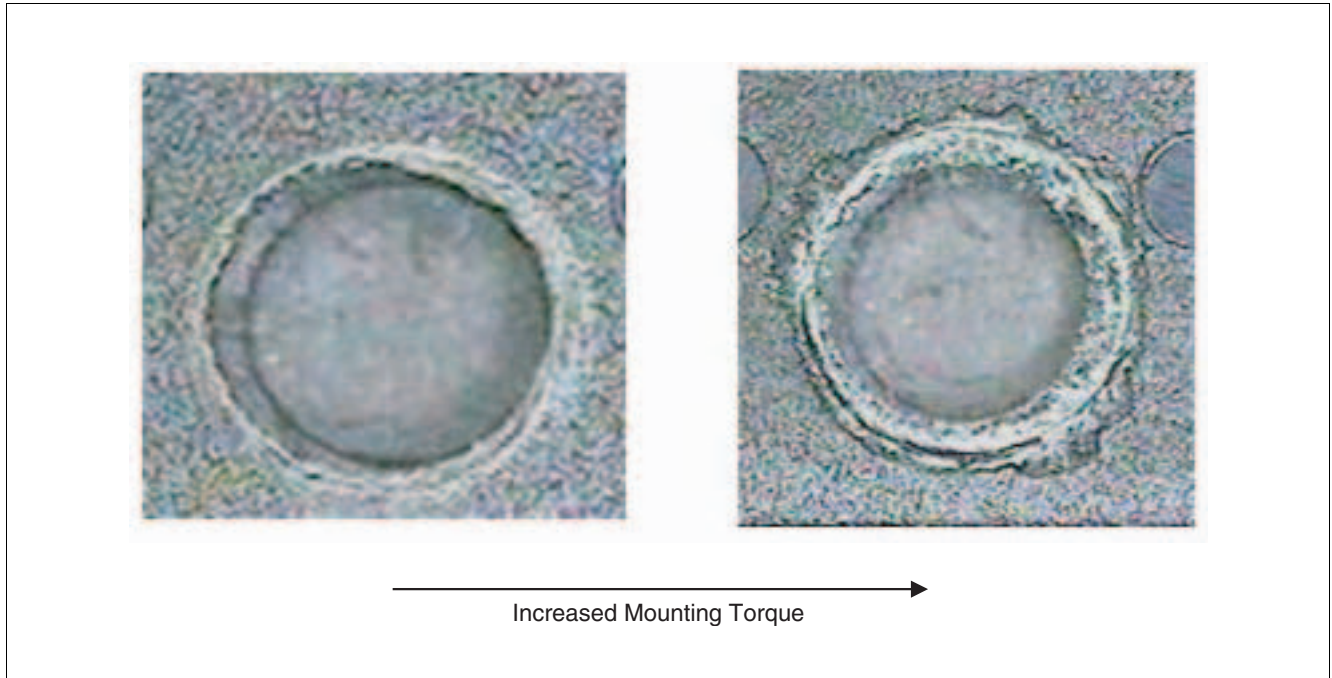

Figure 13 On the right, impressions caused by overtightening of the screw (TO220FP) can be seen

4.3.2 Heatsink Clip Mounting

The clip-mounting method has become popular because it is simple and reliable. The process is fast and appropriate for mass-production assembly. The screw mounting is applied at on one end of the package during fastening. This causes uneven contact pressure and a bad thermal contact. By comparison, the clip is mounted on the package center over the die and this results in more uniform contact pressure and good thermal contact. Using clip mounting ensures that the force is applied above the silicon.

For heatsinks less than 5 mm in thickness, saddle clips should be used (see [Figure 14](#)). These produce contact forces between 15 N and 50 N.

For heatsinks greater than 5 mm in thickness, U clips are used. These produce contact forces between 15 N and 50 N.

There are a number of proprietary clip solutions where the clip is anchored in a feature in an extruded heatsink. Contact forces between 25 N and 50 N can be achieved.

If clips are used, the contact area between the plastic case and the clip must be treated carefully. The maximum pressure allowed on plastic is 150 N/mm². Above this value, cracks in the molded body may appear. Therefore, clips have to be round or smooth in the contact area to avoid concentrated loads on the plastic body of the package.

For some applications, it is necessary to have the package electrically isolated from the heatsink or PCB. The differences can be seen in [Figure 15](#).

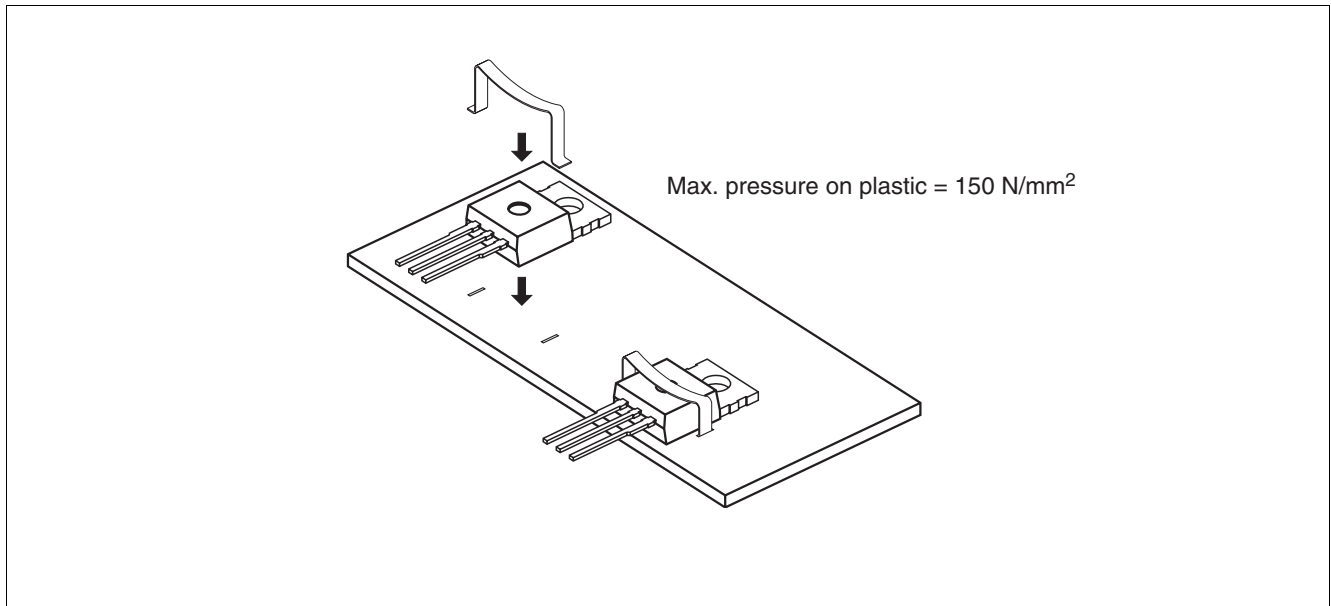

Figure 14 Schematic Drawing of Clip Mounting (saddle-clip)

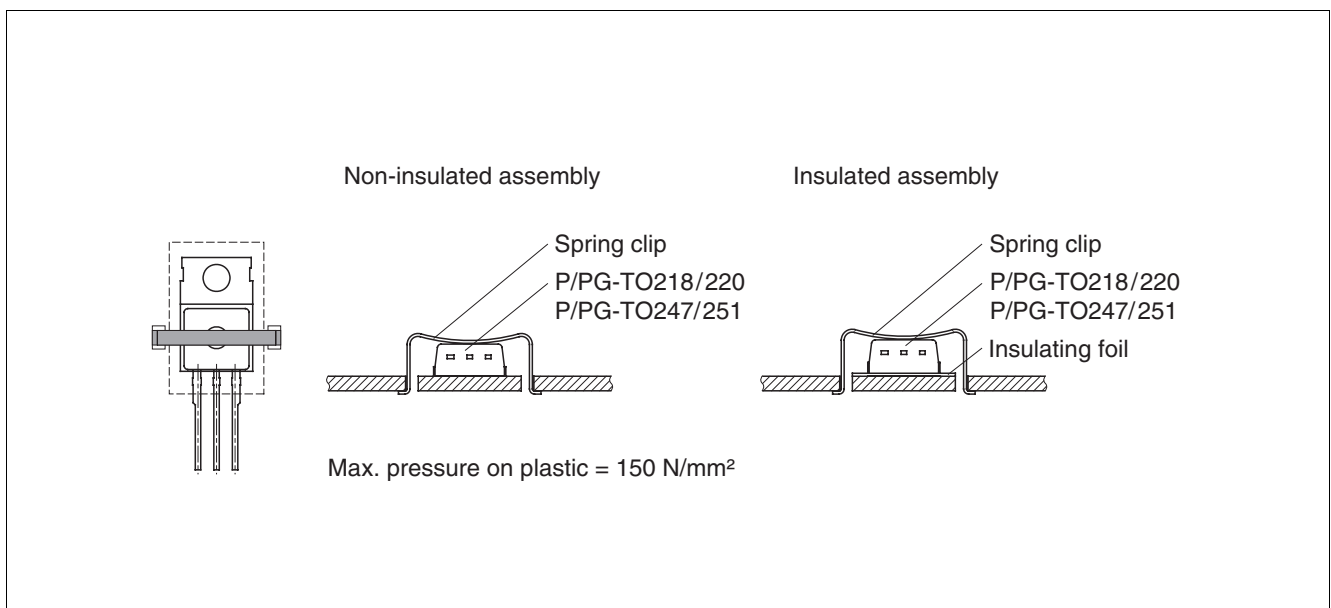

Figure 15 Examples of Clip Mounting Options for Insulated and Non-insulated Assemblies

4.4 Soldering of Through-hole TOs

THDs are typically soldered by wave soldering. However, as the number of THDs on a board continues to decrease in some applications, wave soldering becomes less cost-effective, so the few remaining THDs (mostly connectors and special components) are soldered with selective wave soldering or with pin-in-paste techniques plus reflow soldering.

Through-hole TOs in particular are often mounted on a carrier or submount that has special features so it can serve as a good heatsink. In this case, special processes are needed to attach the component.

4.4.1 Selective Wave Soldering of THDs

Wave soldering is a large-scale soldering process by which electronic components are soldered to a PCB to form an electronic assembly. The name is derived from the fact that the process uses a tank to hold a quantity of molten solder; the components are inserted into or placed on the PCB and the loaded PCB is passed across a pumped wave or cascade of solder. The solder wets the exposed metallic areas of the board (those not protected with solder mask), creating a reliable mechanical and electrical connection.

For THD TOs, only the leads that extend through the drill holes in the PCB contact the hot solder. The body of the package is heated by the hot leads. This has two consequences:

1. The package body is cooler than in the case of reflow soldering
2. The temperature gradient between leads and body and inside the package is greater than in the case of reflow soldering.

Therefore, for wave-solderable THD the heat resistance is tested according to JESD22-B106 and IEC668 2-20 (typically 260°C, 10 s).

Immersion of the whole package body into the molten solder is not recommended since generally THD TOs are not designated for such a harsh temperature shock.

For evaluation on the capability to withstand full body immersion please see also JESD22-A111.

There are many types of wave-soldering machines, but their basic components and principles are the same. A standard wave-soldering machine consists of three zones: the fluxing zone, the preheating zone, and the soldering zone. A fourth zone, the cleaning zone, may be used depending on the type of flux applied.

Dual-wave soldering is the most commonly used wave-soldering method (please see [Figure 16](#)). The peak temperatures, ramp rates, and times that are used depend on the materials and the wave-soldering equipment.

The first wave has a turbulent flow and therefore guarantees a wetting of nearly all shapes of leads and board pads, but also creates an increased number of unwanted solder bridges. These solder bridges have to be removed by the second, laminar wave.

When using lead-free solder alloys, a nitrogen atmosphere is recommended.

Selective wave soldering is used when only a few THDs have to be soldered onto the board. Generally this is done after the other components are already soldered by reflow soldering. This requires effective protection of these components undergoing the selective wave soldering. This protection can be achieved either by using special fixtures and deflectors for the PCB or/ and a small wave shape achieved by using special wave-guiding tubes or covers.

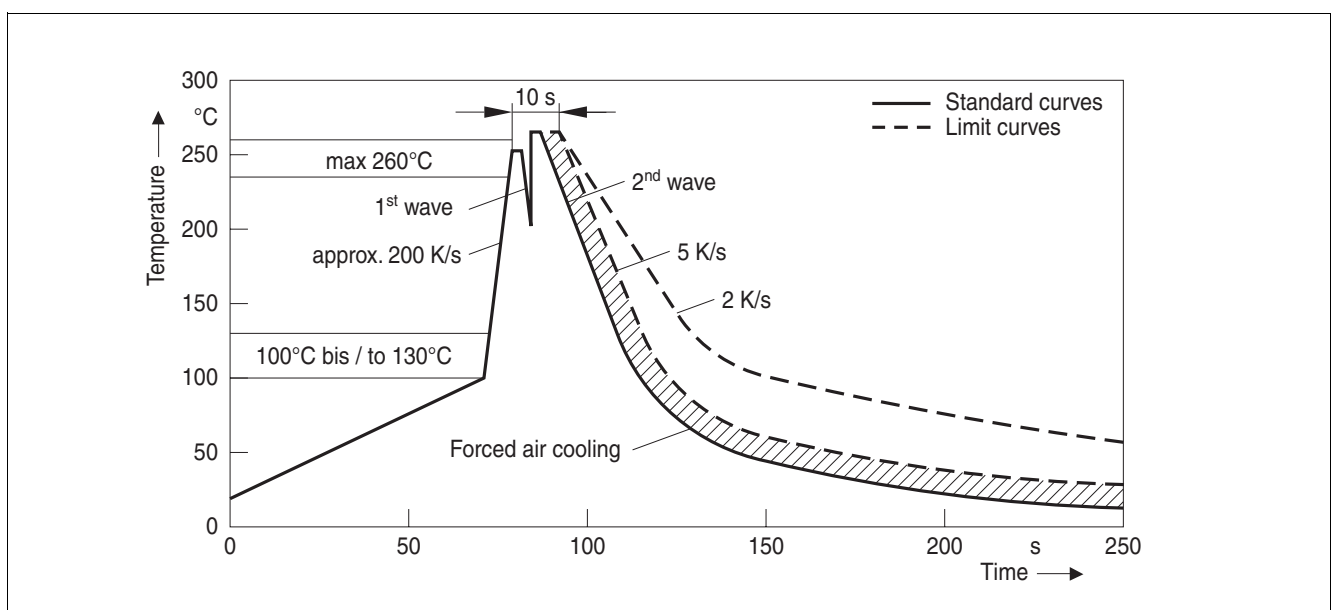

Figure 16 Typical Dual-wave Soldering Profile

4.4.2 Other Soldering Techniques

Beside wave and reflow soldering, other techniques are used in special applications. Examples include selective wave soldering, laser welding and laser soldering, hot bar soldering, and manual soldering with solder irons and hot air guns.

For this broad group of soldering techniques, which cannot be tested for every component, some general guidelines should be followed:

- The maximum temperature of the package body and leads must not exceed the maximum allowed temperature for reflow or wave soldering.
- The maximum allowed time at high temperatures must not exceed the maximum allowed time for reflow or wave soldering.
- If heat is applied to the leads, the maximum temperatures in the package and of the package body must not exceed the maximum allowed temperatures during reflow or wave soldering.
- For details and special arrangements, please refer to the product data sheet and/or qualification report.

If long contact and heating times are unavoidable, the resulting temperatures on different leads near the package body should be measured and compared to the temperatures and duration achieved during wave or reflow soldering, which must not be exceeded.

Please ask your local sales, quality, or application engineer to provide you the evaluation report for further information if needed.

4.4.3 Pin-in-Paste

Another technique used to solder THDs is to print solder paste onto a PCB near or over drill holes through which the leads are then inserted. The reflow of the solder paste is done together with soldering the SMDs, which therefore have to go through the reflow temperature profile. This has two consequences:

1. The temperature is nearly the same for the whole package in contrast to wave soldering.
2. The time for which the peak temperature is applied to the package is much longer compared to wave soldering.

Through-hole TOs are qualified for wave soldering and not for reflow soldering. Therefore, pin-in-paste soldering techniques are not recommended for through-hole TOs.

4.4.4 Heatsink Mounting by Reflow Soldering

In special applications the heatsinks of high-power THDs can be mounted to the board by solder paste printing, pick&place, and reflow soldering. In this case, the packages undergo a reflow profile.

Through-hole TOs are qualified for wave soldering and not for reflow soldering. Therefore, reflow soldering should not be used for heatsink mounting for through-hole TOs.

5 Mounting of Surface-mount TOs

5.1 Main Influences on Surface-mount TO Assembly Quality

The following factors have to be taken into account to achieve the best assembly quality for a given application:

- PCB (please refer to [Chapter 3](#))
- Footprint and stencil layout
- Solder paste
- Solder paste application and inspection
- Component placement
- Reflow soldering process; especially reflow profile
- Solderability of package

5.2 Solder Paste

Solder paste consists of solder alloy and a flux system. Normally the volume is split into about 50% alloy and 50% flux and solvents. In term of mass, this means approximately 90 wt% alloy and 10 wt% flux system and solvents. The flux system has to remove oxides and contamination from the solder joints during the soldering process. The capability of removing oxides and contamination is given by the respective activation level.

The contained solvent adjusts the viscosity needed for the solder paste application process. The solvent has to evaporate during reflow soldering.

The metal alloy in Pb-containing solder pastes is typically eutectic SnPb or near eutectic SnPbAg. Lead-free solder pastes contain so-called SAC-alloys (typically 1 - 4% Ag and < 1% Cu). A “no-clean” solder paste is preferred for all packages where cleaning below the component (e.g. leadless packages, packages with exposed die pad) is difficult. The paste must be suitable for printing the solder stencil aperture dimensions; type 3 paste is recommended. Solder paste is sensitive to age, temperature, and humidity. Please follow the handling recommendations of the paste manufacturer.

5.3 Solder Paste Application

Solder paste is usually applied onto the PCB metal pads by stencil printing. Screen printing or dispensing is used only for special applications.

The volume of the printed solder paste using screen printing is determined by the screen opening and the screen mesh.

The volume of the printed solder paste using stencil printing is determined by the stencil aperture and the stencil thickness.

In most cases, the solder paste volume, the screen mesh, and the stencil thickness must meet the needs of all components on the PCB.

Using solder paste dispensing instead of past printing enables a better adjustment of solder paste volume. As a sequential method it is less suitable for high volume production.

For packages in which all leads are the same size, a typical screen opening or stencil aperture is reduced to 90% of the landing pad size.

For packages in which the leads are different sizes, the solder paste volume has to be matched properly to avoid swimming, tilting, solder beading, or “tombstoning” by using appropriate screen openings and stencil apertures.

Especially big exposed pads in the center of the component tend to tilt the component if the solder paste volume is not reduced sufficiently. Melted solder always tends to form a spherical shape (lowest surface tension) and therefore big pads that are fully covered with solder paste will give a higher stand-off after reflow than smaller pads. This causes tilting of the component, and the different solder depots have to be adjusted.

A segmentation of the stencil for exposed pads or other big pads is shown in [Figure 17](#). It also shows open vias that are located in the cross-over points of the segmentation, which prevents direct printing of solder paste into these vias.

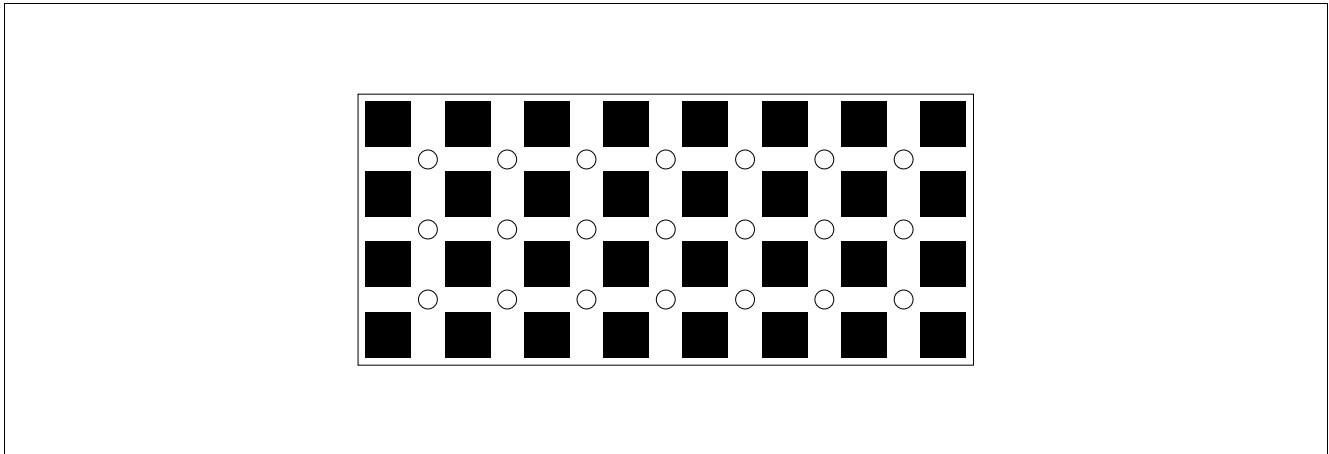

Figure 17 Stencil Segmentation and Via Locations for Exposed Die Pads

Due to the fact that the stand-off also depends on the wetting behavior of the board finish, the optimum volume has to be determined by the customer, and the via technology that is used also has to be taken into account. Beside the target stand-off and/or solder-joint volume, the stencil thickness is also determined by the smallest aperture of the stencil.

The following rule of thumb can be used:

$$A_{\text{apert}} > F \times A_{\text{wall}}$$

A_{apert} : area of the aperture in the stencil

e.g. for a round aperture with radius r : $A_{\text{apert}} = \pi \times r^2$

A_{wall} : area of the wall of the aperture

e.g. for a round aperture with radius r and stencil thickness d : $A_{\text{wall}} = 2\pi \times r \times d$

F : feasibility factor, which depends on the stencil and printing process quality and the used solder paste

e.g. for conservative processes: $F = 0.8$; for advanced processes: $F = 0.6$

To ensure a uniform and high solder paste transfer to the PCB, laser-cut (mostly made from stainless steel) and electroformed stencils (Nickel) are preferred. Rounding the corners of rectangular apertures (radius $\sim 50 \mu\text{m}$) can also support good paste release, and a factor $F = 0.6$ can be achieved.

5.4 Solder Paste Inspection

For inspection of solder paste depots after printing, vision systems that are either integrated into the printer or separate Automatic Optical Inline (AOI) equipment can be used.

The solder paste x-y-cover and solder paste volume can be measured. Adequate acceptance criteria have to be defined. 80% of maximum cover and volume are achievable values in mass production.

5.5 Component Placement

Although the self-alignment effect due to the surface tension of the liquid solder will support the formation of reliable solder joints, the components have to be placed accurately according to their geometry. Positioning the packages manually is not recommended but is possible, especially for packages with big terminals and pitch.

For packages with a pad width of 0.3 mm or less and a pitch of 0.65 or less, an automatic pick&place machine is recommended to achieve reliable solder joints.

Component placement accuracies of $\pm 50 \mu\text{m}$ are obtained with modern automatic component placement machines using vision systems. With these systems, both the PCB and the components are optically measured and the components are placed on the PCB at their programmed positions. The fiducials on the PCB are located

either on the edge of the PCB for the entire PCB or additionally on individual mounting positions (local fiducials). They are detected by a vision system immediately before the mounting process. Recognition of the packages is performed by a special vision system, enabling the complete package to be centered correctly.

The maximum tolerable displacement of the components is 20% of the metal pad width on the PCB (for non-solder-mask defined pads). For example, for exposed die pad LQFP packages with 0.5 mm lead pitch, the device-pad-to-PCB-pad misalignment has to be less than 50 μm to assure a robust mounting process. Generally this is achievable with a wide range of placement systems.

The following factors are important:

- Especially on large boards, local fiducials close to the device can compensate for PCB tolerances.
- The lead recognition capabilities of the placement system should be used rather than the outline centering. Outline centering can only be used for packages where the tolerances between pad and outline are small compared to the placement accuracy needed.
- To ensure the identification of the packages by the vision system, adequate lighting as well as the correct choice of measuring modes is necessary. The correct settings can be taken from the equipment manuals.
- Too much placement force can squeeze out solder paste and cause solder joint shorts. On the other hand, not enough placement force can lead to insufficient contact between package and solder paste and may result in insufficient sticking of the component on the solder paste, which may then lead to shifted or dropped devices.
- A pick-up nozzle suitable for the package body size should be used. The nozzle should be slightly smaller than the package body. A bigger nozzle may lead to an irregular force distribution, especially to increased forces at the edges of the package body. On the other hand, a nozzle that is too small may lead to increased forces in the package center. Package bodies that are divided into different areas that have different heights require special care when choosing the nozzle. Nozzle shape and size are probably more critical in these cases.

5.6 Reflow Soldering

The goal of the reflow process is to melt the powder particles in the solder paste, with the surfaces being joined together, and solidify the solder to create a strong metallurgical bond. There are usually four process zones in a conventional reflow process, consisting of preheat, thermal soak, reflow, and cooling.

Generally standard reflow soldering processes such as

- Forced convection
- Vapor phase
- Infrared (with restrictions)

and typical temperature profiles are suitable for board assembly.

During the reflow process, solder joints have to be exposed to temperatures above the melting point of solder for a sufficient time to get the optimum solder-joint quality, whereas overheating the PCB with its components has to be avoided. Please refer to the bar code label on the packing for the maximum package body temperature. It is important that the maximum temperature of the package during the reflow does not exceed the specified peak temperature on the moisture level caution label.

When using infrared (IR) ovens without convection, special care may be necessary to assure a sufficiently homogeneous temperature profile for all solder joints on the PCB, especially on large, complex boards with different thermal masses of the components. In IR soldering, the components are heated as a result of absorbing IR radiation. Usually the heating is done with radiators positioned on either side in order to heat or preheat the whole area surrounding the solder joint, if possible. The temperature of the different components may vary significantly. Since the metallic terminals of the components exhibit only low absorption, i.e. they reflect IR radiation, the heat has to be supplied to the solder joints via the component itself, the similarly heated PCB, and the ambient air.

Absorption depends on the material and the wavelength, and the latter, in its turn, depends on the radiator temperature. Large and thick packages take longer to get hot than small and thin ones. Special care has to be taken when large exposed die pads are soldered by IR radiation, because the solder joints between the package and the PCB heat up much more slowly than the environment. Precautions must be taken by empirically varying the radiator temperature and the conveyor speed to ensure that neither the minimum soldering temperature nor

the maximum temperature is exceeded at any point. This must be ensured by specific temperature measurements.

Compared to forced convection and especially IR soldering, a vapor-phase oven has the least risk of overheating because it uses special fluids with a vapor temperature slightly above the melting point of the solder alloy used. The atmosphere is free of oxygen. One disadvantage is that most vapor-phase ovens are designed for batch processing and not conveyor driven. This makes it difficult to use them in mass-production lines.

The most highly recommended reflow process is forced convection, which is normally used in mass production. The heat in forced convection is transferred to the PCB in different zones by heated air or nitrogen. The number of zones, volume of hot gas, and oven design determine the capacity and the ability to reproduce the optimum reflow profile, which is influenced by:

- Board thickness and layout
- Differences in thermal mass of all components
- Maximum allowed component temperatures
- Recommended reflow profile for the solder paste

Using a nitrogen atmosphere can generally improve solder-joint quality, but is normally not necessary for soldering the available package lead finishes. For the lead-free process with higher reflow temperatures, a nitrogen atmosphere may reduce oxidation and improve the solder-joint quality.

The temperature profile of a reflow process is divided into several phases, each with a special function. The individual parameters are influenced by various factors, not only by the package. First, it is essential to follow the solder paste manufacturer's application notes. Additionally, most PCBs contain more than one package type and therefore the reflow profile has to be matched to all components' and materials' demands. We recommend measuring the solder joints' temperatures by thermocouples beneath the various packages. Components with large thermal masses do not heat up at the same speed as lightweight components, and the position and the surrounding of the package on the PCB, as well as the PCB thickness, can influence the solder-joint temperature significantly.

Figure 18 shows a generalized forced-convection reflow profile for soldering SMD and THD packages. **Table 5** shows an example of the key data of such a solder profile for tin-lead and for lead-free alloys. The given data is an example, not a recommendation (for reference only).

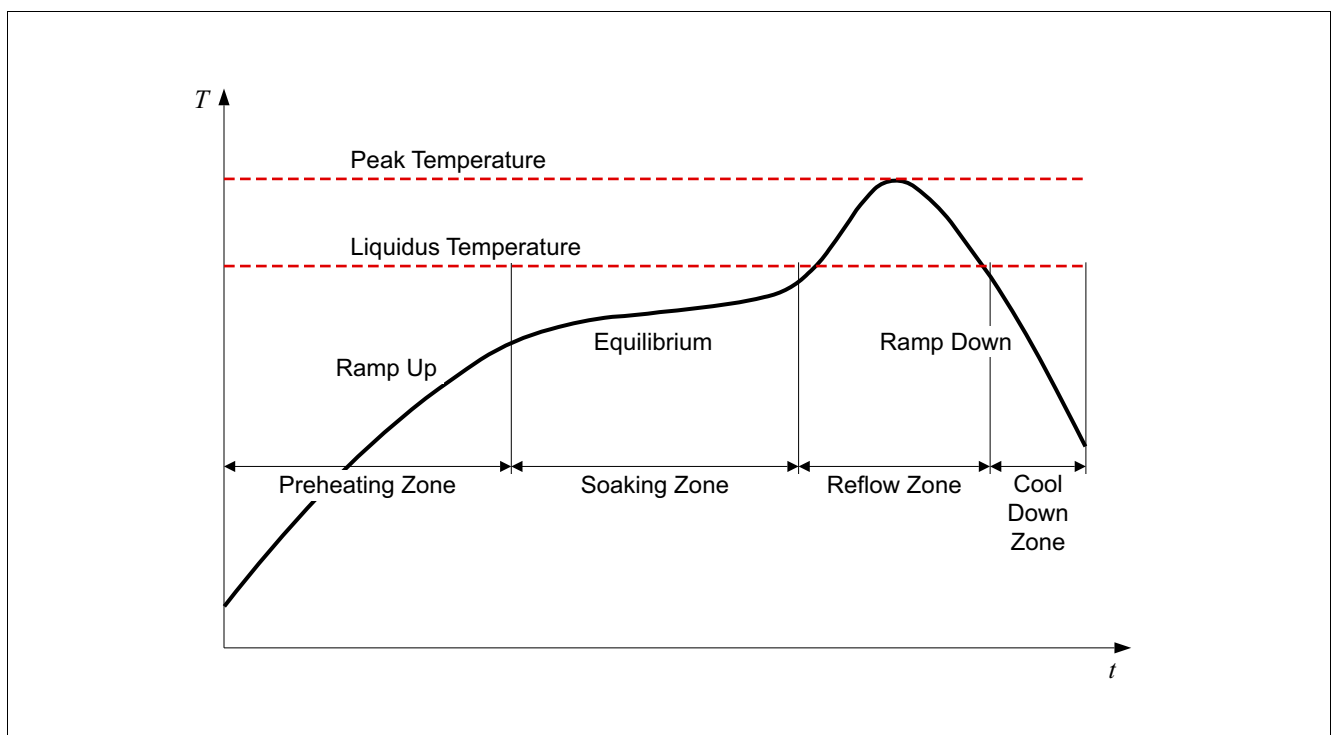

Figure 18 Generalized Forced Convection Reflow Solder Profile

Table 5 EXAMPLE of the Key Data of a Forced Convection Reflow Solder Profile.
Solderability of Through-hole TOs

Parameter	Tin-lead Alloy (SnPb or SnPbAg)	Lead-free Alloy (SnAgCu)	Main Requirements From
Preheating rate	2.5 K/s	2.5 K/s	Flux system (Solder paste)
Soaking temperature	140 - 170°C	140 - 170°C	Flux system (Solder paste)
Soaking time	80 s	80 s	Flux system (Solder paste)
Peak temperature	225°C	245°C	Alloy (Solder paste)
Reflow time over Liquidus	60 s	60 s	Alloy (Solder paste)
Cool down rate	2.5 K/s	2.5 K/s	

6 Cleaning

After the soldering process, flux residues can be found around the solder joints. If a “no-clean” solder paste or flux has been used, the residues usually do not have to be removed. However, if the solder joints have to be cleaned, the cleaning method (e.g. ultrasonic, spray, or vapor cleaning) and solution have to be selected with consideration of the packages to be cleaned, the flux used (rosin-based, water-soluble, etc.), and environmental and safety aspects. Removing/drying even of small residues of the cleaning solution should also be done very thoroughly. Contact the flux or solder paste manufacturer for recommended cleaning solutions. Cleaning the solder joint of exposed die pads could be more difficult than cleaning the leads, which are more exposed to outside treatment.

7 Inspection

After component placement:

A visual inspection after component placement can be done by AOI. It is used to check if the mounting is done completely and if severe misplacements have occurred. Sometimes the correct orientation of the component can also be checked.

After soldering:

The solder joint meniscus of the leads of TOs can be inspected by optical microscope or AOI. Acceptable solder joints are described in international standards such as IPC-A-610.

Figure 19: shows a THD lead with optimal wetting. It has to be assured that a metallized via is filled properly. This cannot be detected by visual inspection, but can be done by x-ray and/or cross sectioning.

Figure 20 shows a SMD lead with optimal wetting. For surface-mount TOs, it may also be necessary to assess the joint quality under leads with x-ray and/or cross sectioning.

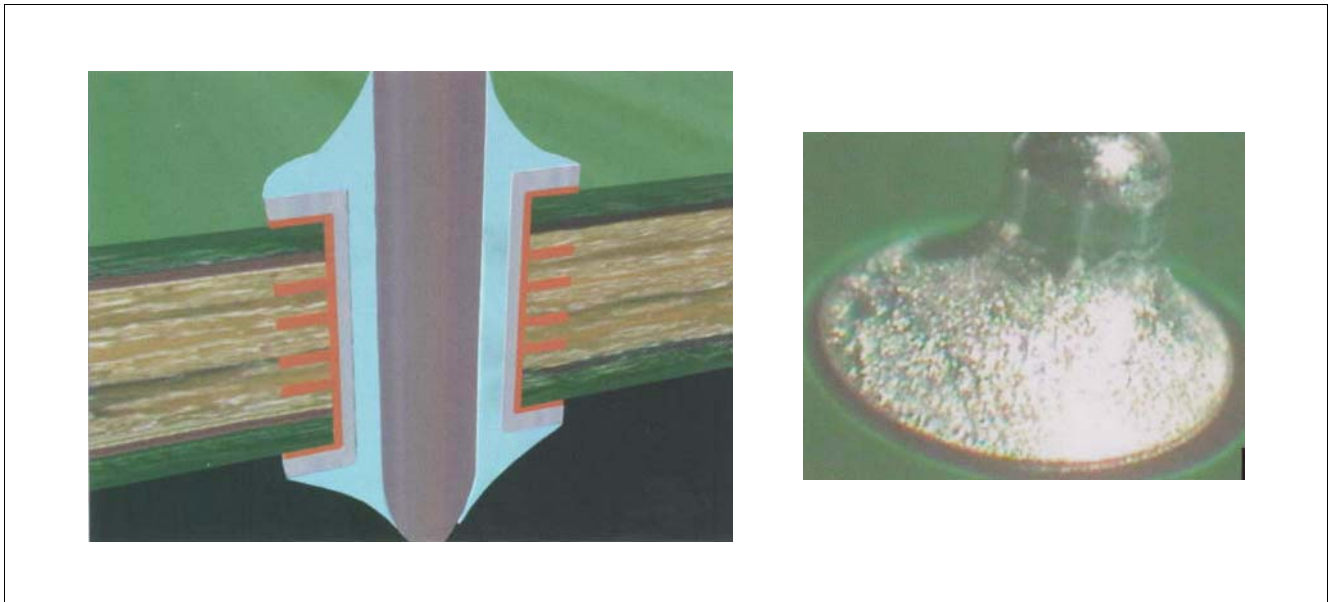

Figure 19 Example of a Optimally Wetted THD Lead

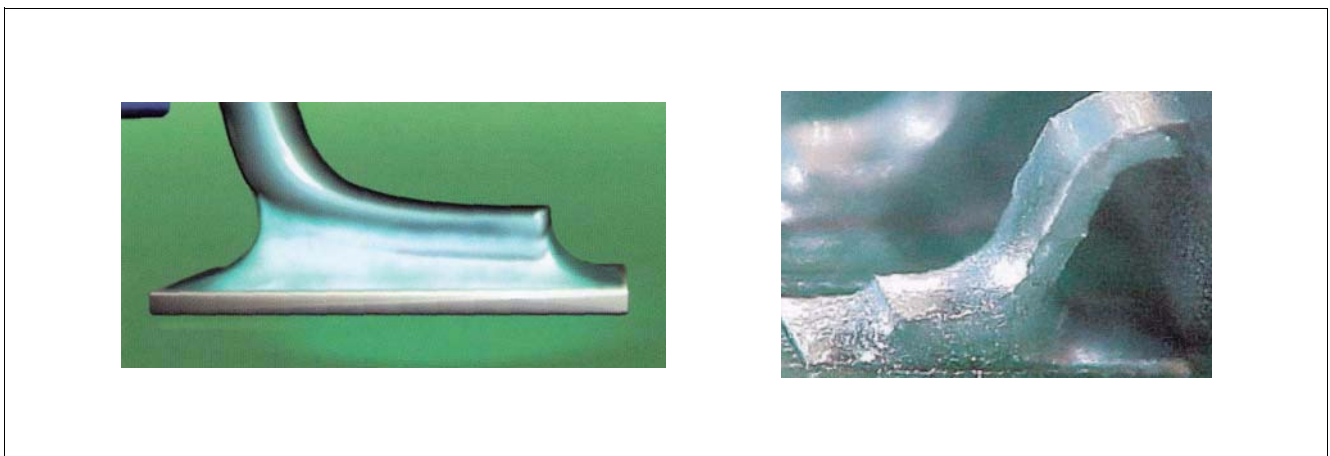

Figure 20 Example of a Optimally Wetted SMD Lead

If exposed die pads are soldered, X-ray is the only reliable method to inspect the whole solder joint. **Figure 21** shows an example of a TO package. The only optically accessible areas are leadframe areas that extend beyond the package body.

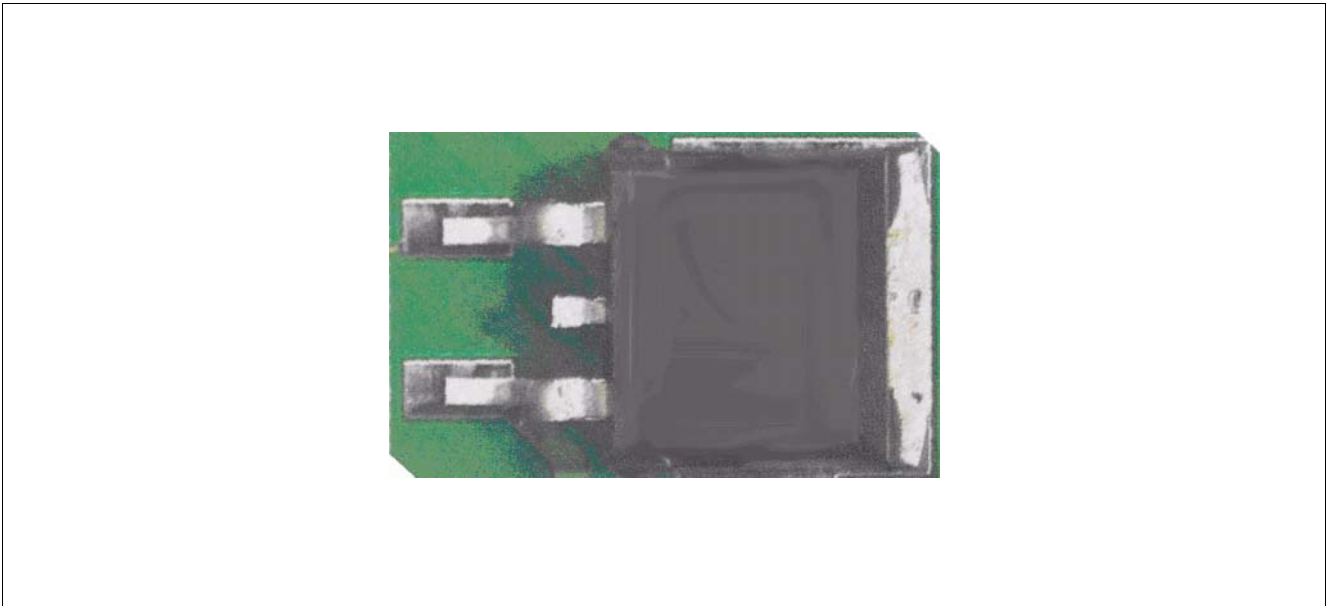

Figure 21 Example of a Optimally Wetted Surface-mount TO Package

Automatic X-ray Inspection (AXI) is the only reasonable method for efficient inline control. AXI systems are available as 2D and 3D solutions. They usually consist of an X-ray camera and the hardware and software needed for inspection, controlling, analyzing, and data-transfer routines. These systems enable the user to reliably detect soldering defects such as poor soldering, bridging, voiding, and missing parts. For the acceptability of electronic assemblies, please refer also to the IPC-A-610C standard.

Cross sectioning of a soldered package as well as dye penetrant analysis can serve as tools for sample monitoring only, because of their destructive character. Nonetheless, these analysis methods must be used during engineering of new products at customers' production sites to get detailed information about the solder-joint quality.

Lead-free solder joints look different from tin-lead (SnPb) solder joints. Tin-lead solder joints typically have a bright and shiny surface. Lead-free (SnAgCu) solder joints typically do not have this bright surface. Lead-free solder joints are often dull and grainy. These surface properties are caused by the irregular solidification of the solder, as the solder alloys are not exactly eutectic (like the 63Sn37Pb solder alloy). This means that SnAgCu-solders do not have a melting point but a melting range of several degrees. Although lead-free solder joints have this dull surface, this does not mean that lead-free joints are of lower quality or weaker than the SnPb joints. It is therefore necessary to teach the inspection staff what these lead-free joints look like, and/or to adjust optical inspection systems to handle lead-free solder joints.

8 Rework

If a defective component is observed after board assembly, the device can be removed and replaced by a new one. Repair of single solder joints is generally possible, but requires proper tools. For example, repairing the solder joint of an exposed die pad cannot be done with a soldering iron.

Whatever rework process is applied, it is important to recognize that heating a board and components above 200°C may result in damage. As a precaution, every board with its components has to be baked prior to rework. For details, please refer to [Chapter 5.2](#) and the international standard J-STD-033.

In any case, mechanical, thermal, mechanical or thermo-mechanical overstress has to be avoided, and rework has to be done according to JEDEC J-STD-033A, IPC-7711 and IPC-7721.

8.1 Device Removal

If a defective component is going to be sent back to the supplier, no further defects must be caused during the removal of this component, because this may hinder the failure analysis by the supplier. The following recommendations should be considered:

- *Moisture*: Depending on the MSL, the package may have to be dried before removal. If the maximum storage time out of the dry pack (see label on packing material) is exceeded after board assembly, the PCB has to be baked according to the recommendations of the PCB manufacturer. Otherwise, too much moisture may have been accumulated and damage may occur (“popcorn” effect).
- *Temperature profile*: During the desoldering process it should be assured that the package peak temperature is not higher and temperature ramps are not steeper than for the standard assembly wave or reflow process.
- *Mechanics*: Be careful not to apply high mechanical forces for removal. Otherwise failure analysis of the package can be impossible, or PCB can be damaged. For large packages, pipettes can be used (implemented on most rework systems); for small packages, tweezers may be more practical.

8.2 Site Redressing

After removing the defective component, the pads on the PCB have to be cleaned to remove solder residues. This may be done by vacuum desoldering or wick.

Don't use steel brushes because steel residues can lead to bad solder joints. Before placing a new component, it may be necessary to apply solder paste on PCB pads by printing (special micro-stencil) or dispensing.

8.3 Reassembly and Reflow

After preparing the site, the new package can be placed onto the PCB and the leads are to be inserted into the holes. Regarding placement accuracy and placement force, the process should be comparable to the (automatic) pick&place process. During the soldering process, it should be assured that the package peak temperature is not higher and temperature ramps are not steeper than for the standard assembly process. Soldering wire can be used to resolder the leads. Use only no-clean solder paste, solder wire, and flux for repair.

9 Coating of Assembled PCBs

In some applications, coatings are used to prevent damage due to external influences such as:

- Mechanical abrasion
- Vibration
- Shock
- Humidity
- Hand perspiration
- Chemicals and corrosive gases

These influences may cause:

- Electrical leakage due to humidity.
- Corrosion that leads to degradation of conductor paths, solder joints, and any other metallized areas; and/or formation of electrical leakage paths. These can eventually result in electrical shorts (electrical leakage) or open contacts.
- Mechanical damage to conductor paths, solder joints, and components. This damage can lead to electrical failures.

Coatings act as electrically isolating and impervious covers that adhere well to the different PCB materials.

A wide variety of different coatings is available on the market. They differ in:

- Price
- Simple processability (spray, dip, casting, curing, etc.)
- Repairability
- Controllability
- Homogeneity

In any case, please be aware of the chemical, electrical, mechanical and thermo-mechanical interaction between the coating and the PCB and its components. Coatings can affect component reliability.

9.1 List of References

IPC/EIA/JEDEC-J-STD-006 (Requirements for Electronic Grade Solder Alloys and Fluxed and Non-fluxed Solid Solders for Electronic Soldering Applications)

IPC/EIA/JEDEC-J-STD-001 (Requirements for Soldered Electrical and Electronic assemblies)

IPC A-610 (Acceptability of Electronic Assemblies)

IPC/JEDEC J-STD-033/-020 (Handling, Packing, Shipping and Use of Moisture/Reflow Sensitive Surface Mount devices)/(Moisture/reflow Sensitivity Classification for Nonhermetic Solid State Surface Mount Devices)

JESD22-B102 (Test Method for Solderability)

IEC 60068-2-58 (Test methods for solderability, resistance to dissolution of metallization and to soldering heat of surface mounting devices)

IPC 7351/7355 (Generic Requirements for Surface Mount Design and Land Pattern Standard)

www.infineon.com