

Integrated POL Voltage Regulator Product Selection Guide

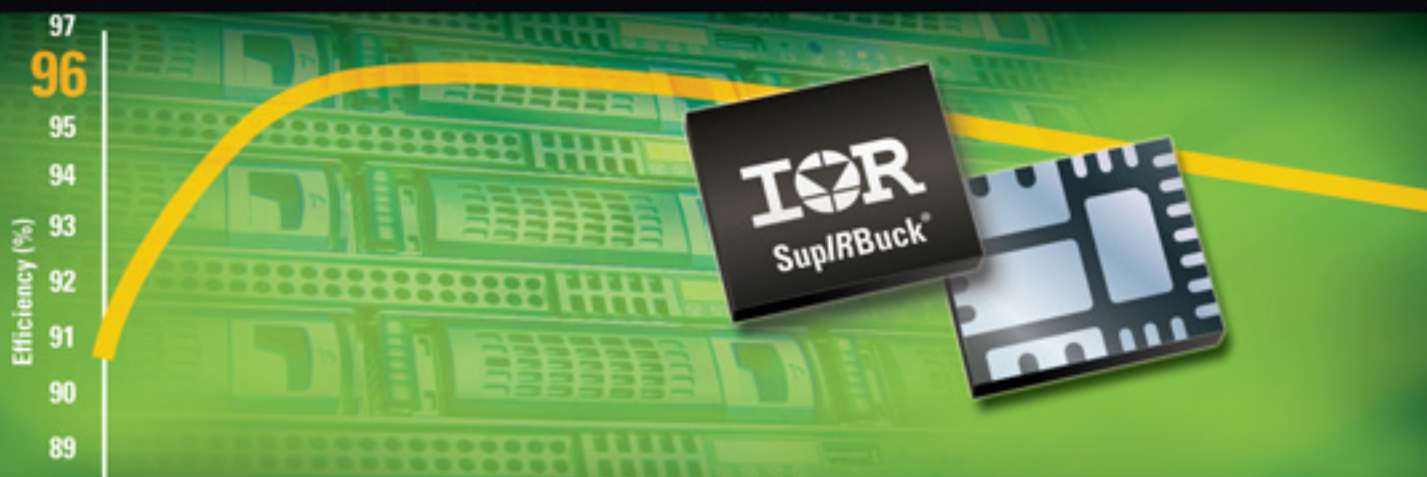

International
IOR Rectifier

AN INFINEON TECHNOLOGIES COMPANY

WWW.IRF.COM

The IR Advantage

- Best-in-class efficiency
- Common series footprint enables “cut and paste” design and scalability for faster time to market
- Single stage conversion saves energy, size and cost by eliminating the need for an intermediate bus
- Low profile and excellent thermal performance allows back-side board mounting
- Integrated solution and high switching frequency offer high power density with reduced component count

Integrated Voltage Regulator Product Offering

	PWM			Constant On-Time
	1 - 16V	1 - 21V	1.5 - 21V	3 - 27V
	5V bias required	Integrated LDO	5V bias required	
1-3A	IR3843W	IR3823		
2-4A	IR3842W	IR3897*	IR3853	
		IR3891†		
4-6A		IR3839*		IR3473
		IR3892†	IR3856	
		IR3898*		
6-10A		IR3838*	IR3859	IR3475
	IR3841W	IR3899*		
10-16A		IR3837*		IR3476
	IR3840W	IR3894*		IR3477
		IR3895*		
16-25A		IR3847*		
25-35A		IR3846*		

*DDR Tracking

†Dual Output

High Switching Frequency and High Input Voltage

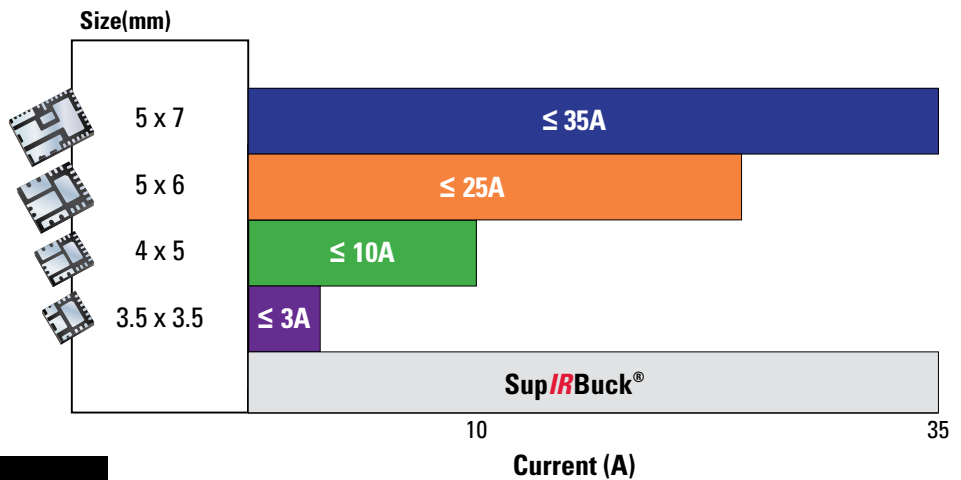
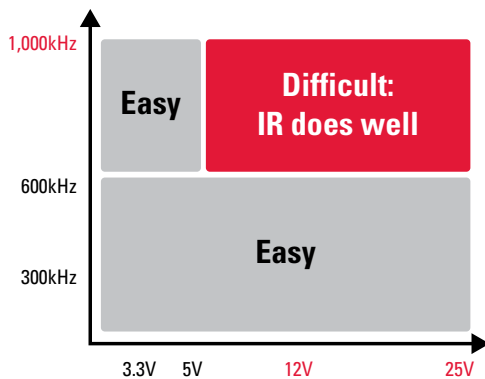

mypower.irf.com/supirbuck

Sup/IRBuck® Online Design Tool Simplifies Design

Comprehensive online design tool featuring parametric search, schematic capture, AC, Steady State, Transient Analysis, Thermal Analysis, BOM creation, and more...

Design Requirements

Design Configuration

Part Selection	Electrical Des
Design Inputs	
Input Voltage	12 V
Output Voltage	1.8 V
Output Current	2 A
Switching Frequency	600 KHz
VCC Bias	5 V

*Higher frequency reduces solution size, lower frequencies increase solution efficiency.

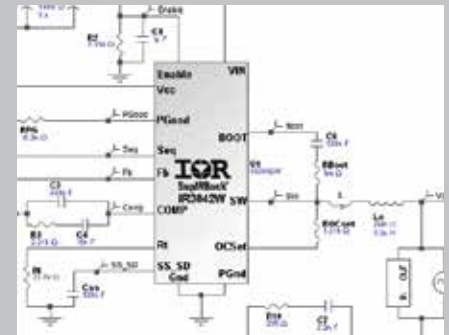

Part Number	Control Method	Self Bias	Max Iout [A]	Max Vin [V]	Accuracy	Programm Over Current Protection	Programm Soft Start	Over Voltage Protection	Freq. Sync.	Margining & Tracking	Differential Remote Sense	Package size
IR3891	PWM	Y	4+4	21	1%	---	---	Latch	Y	---	---	5x6mm
IR3892	PWM	Y	6+6	21	1%	---	---	Latch	Y	---	---	5x6mm
IR3823	PWM	Y	3	21	0.6%	---	Y	Latch	Y	---	---	3.5x3.5mm
IR3897	PWM	Y	4	21	0.5%	---	---	Latch	Y	Y	---	4x5mm
IR3898	PWM	Y	6	21	0.5%	---	---	Latch	Y	Y	---	4x5mm
IR3899	PWM	Y	9	21	0.5%	---	---	Latch	Y	Y	---	4x5mm
IR3894	PWM	Y	12	21	0.5%	---	---	Latch	Y	Y	---	5x6mm
IR3895	PWM	Y	16	21	0.5%	---	---	Latch	Y	Y	---	5x6mm
IR3846	PWM	Y	35	21	0.5%	Y	---	Latch	Y	Y	Y	5x7mm
IR3847	PWM	Y	25	21	0.5%	Y	---	Latch	Y	Y	Y	5x6mm
IR3837	PWM	Y	14	16	1%	Y	---	Flag	Y	Y	---	5x6mm
IR3838	PWM	Y	10	16	1%	Y	---	Flag	Y	Y	---	5x6mm
IR3839	PWM	Y	6	16	1%	Y	---	Flag	Y	Y	---	5x6mm
IR3840W	PWM	---	12	16	1%	Y	Y	Flag	---	---	---	5x6mm
IR3841W	PWM	---	8	16	1%	Y	Y	Flag	---	---	---	5x6mm
IR3842W	PWM	---	4	16	1%	Y	Y	Flag	---	---	---	5x6mm
IR3843W	PWM	---	2	16	1%	Y	Y	Flag	---	---	---	5x6mm
IR3853	PWM	---	4	21	1%	Y	Y	Latch	Y	---	---	4x5mm
IR3856	PWM	---	6	21	1%	Y	Y	Latch	Y	---	---	4x5mm
IR3859	PWM	---	9	21	1%	Y	Y	Latch	Y	---	---	4x5mm
IR3473	COT*	---	6	27	1%	Y	Y	Latch	---	---	---	4x5mm
IR3475	COT*	---	10	27	1%	Y	Y	Latch	---	---	---	4x5mm
IR3476	COT*	---	12	27	1%	Y	Y	Latch	---	---	---	5x6mm
IR3477	COT*	---	15	27	1%	Y	Y	Latch	---	---	---	5x6mm

* Constant On Time control offers improved light load efficiency

Simulation

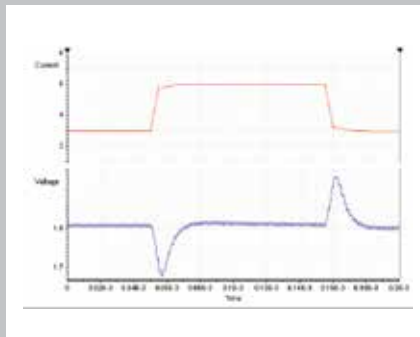

PCB Layout and Thermal Analysis

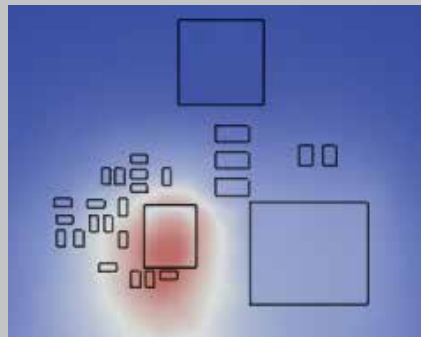

Summary

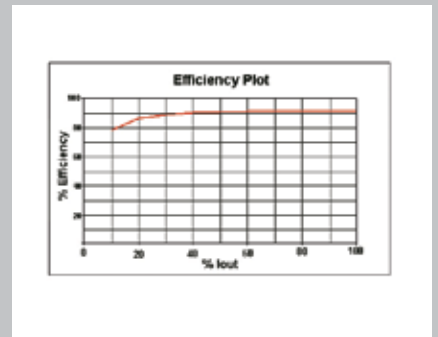

Product Line	Applications	Key Products
 <p>Energy Saving Products Integrated design platforms that enable customers to add energy-conserving features that achieve lower operating energy costs and manufacturing Bill of Material (BOM) costs.</p>	<ul style="list-style-type: none"> • Appliances • Audio • Display • Industrial • Lighting • SMPS 	<ul style="list-style-type: none"> • Digital Control ICs • High-Voltage ICs • IGBTs • IRAM Integrated Power Modules • MERs • μIPM™
 <p>Enterprise Power Optimized power management system solutions that deliver benchmark power density, efficiency and performance in enterprise power.</p>	<ul style="list-style-type: none"> • Servers • Storage Networks • Switchers & Routers • Workstations • Notebooks • Game Stations • Set-Top Box 	<ul style="list-style-type: none"> • DirectFET® plus • SupIRBuck® • PowIRstage® • CHiL Digital Controllers
 <p>Automotive Automotive grade power management solutions qualified to meet the needs of 12V, 24V and HEV/EV applications with a zero defect goal.</p>	<ul style="list-style-type: none"> • AC and DC Motor Drives • Powertrain / Engine control • Body Electronics • Lighting • Class D Audio • Heavy Loads and Actuators 	<p>Automotive Qualified:</p> <ul style="list-style-type: none"> • HEXFET® Power MOSFETs • Intelligent Power Switches • Driver ICs • IGBTs • DirectFET® 2 • COOLiR™
 <p>Benchmark MOSFETs IR continues to lead the industry by offering power MOSFETs with the lowest $R_{DS(on)}$ and widest range of packages up to 250V for a diverse range of applications.</p>	<ul style="list-style-type: none"> • Audio • Computing • Communications • Motor Control • Power Supply • Synchronous Rectification 	<ul style="list-style-type: none"> • Discrete HEXFET® MOSFETs • Dual HEXFET® MOSFETs • FETKY® • DirectFET® • StrongIRFET™ • FastIRFET™
 <p>HiRel Our discrete components, complex hybrid power module assemblies and rugged DC-DC converters utilize leading-edge power technology which, together with demanding environmental specifications help engineers to meet their toughest design challenges.</p>	<ul style="list-style-type: none"> • Space • Military • Commercial Aviation • Rugged Industrial • Medical 	<ul style="list-style-type: none"> • RAD-Hard MOSFETs • Power Modules/Hybrid Solutions • Motor Control Solutions • DC-DC Converters