

V_{DS}	-30	V
$R_{DS(on) max}$ (@ $V_{GS} = -10V$)	0.60	Ω
Q_g (typical)	3.4	nC
I_D (@ $T_A = 25^\circ C$)	-0.76	A

HEXFET® Power MOSFET

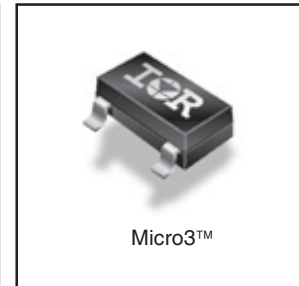
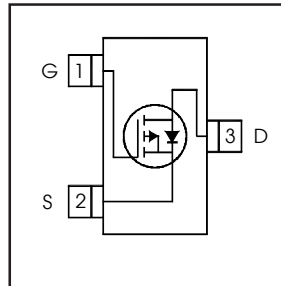

Features

Industry-standard pinout SOT-23 Package
Compatible with Existing Surface Mount Techniques
RoHS Compliant, Halogen-Free
MSL1, Industrial qualification



Benefits

Multi-Vendor Compatibility
Easier Manufacturing
Environmentally Friendlier
Increased Reliability

Base Part Number	Package Type	Standard Pack		Orderable Part Number
		Form	Quantity	
IRLML5103TRPbF-1	Micro3™ (SOT-23)	Tape and Reel	3000	IRLML5103TRPbF-1

Absolute Maximum Ratings

	Parameter	Max.	Units
$I_D @ T_A = 25^\circ C$	Continuous Drain Current, $V_{GS} @ -10V$	-0.76	A
$I_D @ T_A = 70^\circ C$	Continuous Drain Current, $V_{GS} @ -10V$	-0.61	
I_{DM}	Pulsed Drain Current ①	-4.8	
$P_D @ T_A = 25^\circ C$	Power Dissipation	540	mW
	Linear Derating Factor	4.3	mW/°C
V_{GS}	Gate-to-Source Voltage	± 20	V
dv/dt	Peak Diode Recovery dv/dt ②	-5.0	V/ns
T_J, T_{STG}	Junction and Storage Temperature Range	-55 to + 150	°C

Thermal Resistance

	Parameter	Typ.	Max.	Units
$R_{\theta JA}$	Maximum Junction-to-Ambient ④	—	230	°C/W

Electrical Characteristics @ T_J = 25°C (unless otherwise specified)

	Parameter	Min.	Typ.	Max.	Units	Conditions
V _{(BR)DSS}	Drain-to-Source Breakdown Voltage	-30	—	—	V	V _{GS} = 0V, I _D = -250μA
ΔV _{(BR)DSS} /ΔT _J	Breakdown Voltage Temp. Coefficient	—	-0.029	—	V/°C	Reference to 25°C, I _D = -1mA
R _{DS(ON)}	Static Drain-to-Source On-Resistance	—	—	0.60	Ω	V _{GS} = -10V, I _D = -0.60A ③
		—	—	1.0		V _{GS} = -4.5V, I _D = -0.30A ③
V _{GS(th)}	Gate Threshold Voltage	-1.0	—	—	V	V _{DS} = V _{GS} , I _D = -250μA
g _{fs}	Forward Transconductance	0.44	—	—	S	V _{DS} = -10V, I _D = -0.30A
I _{DSS}	Drain-to-Source Leakage Current	—	—	-1.0	μA	V _{DS} = -24V, V _{GS} = 0V
		—	—	-25		V _{DS} = -24V, V _{GS} = 0V, T _J = 125°C
I _{GSS}	Gate-to-Source Forward Leakage	—	—	-100	nA	V _{GS} = -20V
	Gate-to-Source Reverse Leakage	—	—	100		V _{GS} = 20V
Q _g	Total Gate Charge	—	3.4	5.1	nC	I _D = -0.60A
Q _{gs}	Gate-to-Source Charge	—	0.52	0.78		V _{DS} = -24V
Q _{gd}	Gate-to-Drain ("Miller") Charge	—	1.1	1.7		V _{GS} = -10V, See Fig. 6 and 9 ③
t _{d(on)}	Turn-On Delay Time	—	10	—	ns	V _{DD} = -15V
t _r	Rise Time	—	8.2	—		I _D = -0.60A
t _{d(off)}	Turn-Off Delay Time	—	23	—		R _G = 6.2Ω
t _f	Fall Time	—	16	—		R _D = 25Ω, See Fig. 10 ③
C _{iss}	Input Capacitance	—	75	—	pF	V _{GS} = 0V
C _{oss}	Output Capacitance	—	37	—		V _{DS} = -25V
C _{rss}	Reverse Transfer Capacitance	—	18	—		f = 1.0MHz, See Fig. 5

Source-Drain Ratings and Characteristics

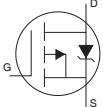
	Parameter	Min.	Typ.	Max.	Units	Conditions
I _S	Continuous Source Current (Body Diode)	—	—	-0.54	A	MOSFET symbol showing the integral reverse p-n junction diode. 
I _{SM}	Pulsed Source Current (Body Diode) ①	—	—	-4.8		
V _{SD}	Diode Forward Voltage	—	—	-1.2	V	T _J = 25°C, I _S = -0.60A, V _{GS} = 0V ③
t _{rr}	Reverse Recovery Time	—	26	39	ns	T _J = 25°C, I _F = -0.60A
Q _{rr}	Reverse Recovery Charge	—	20	30	nC	di/dt = 100A/μs ③

Notes:

- ① Repetitive rating; pulse width limited by max. junction temperature. (See fig. 11)
- ② I_{SD} ≤ -0.60A, di/dt ≤ 110A/μs, V_{DD} ≤ V_{(BR)DSS}, T_J ≤ 150°C
- ③ Pulse width ≤ 300μs; duty cycle ≤ 2%.
- ④ Surface mounted on FR-4 board, t ≤ 5sec.

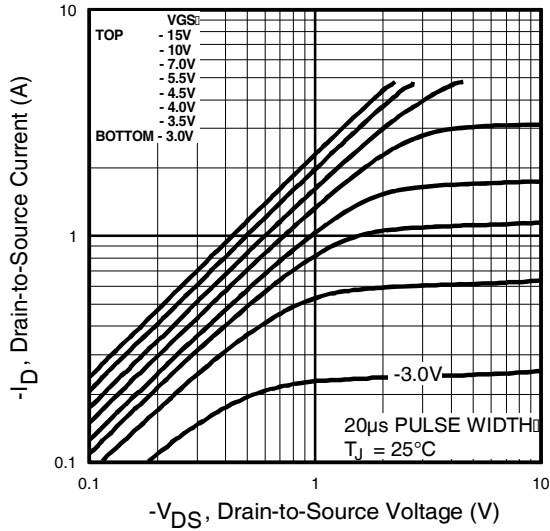
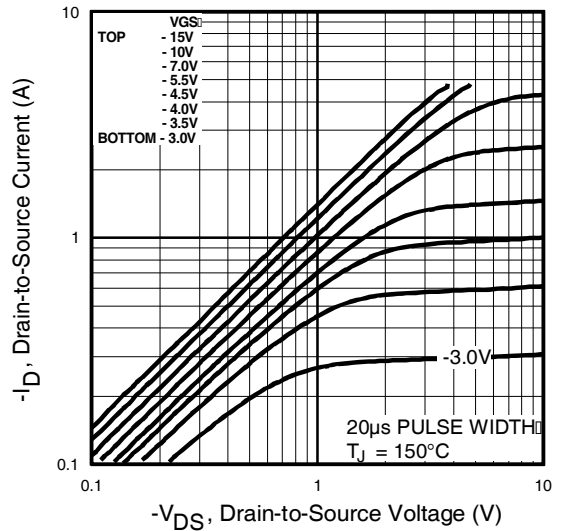
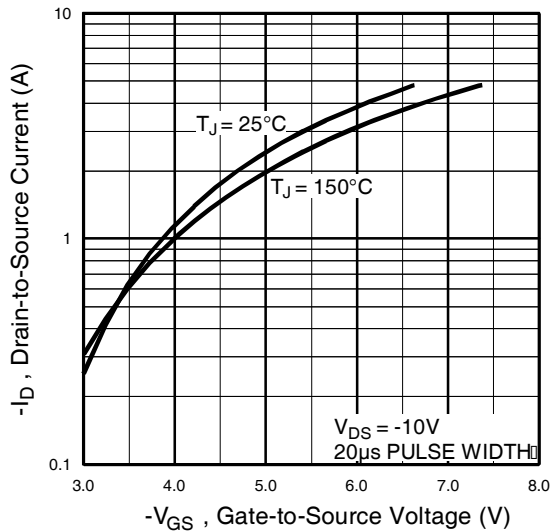
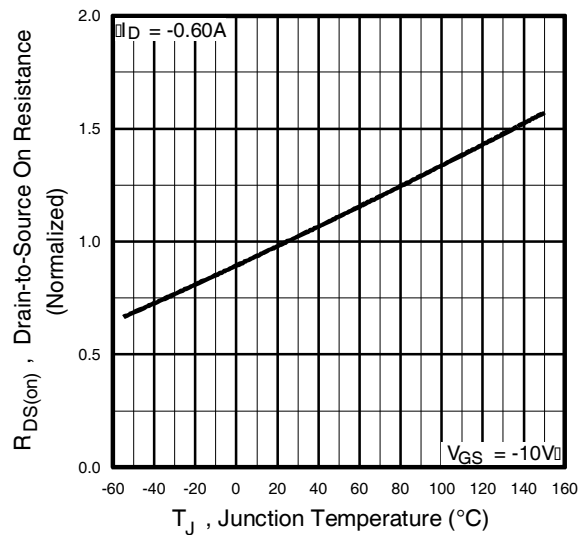
Fig 1. Typical Output Characteristics

Fig 2. Typical Output Characteristics

Fig 3. Typical Transfer Characteristics

Fig 4. Normalized On-Resistance Vs. Temperature

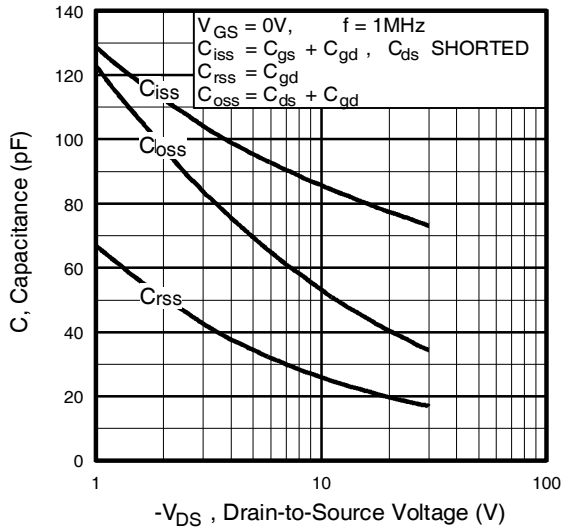

Fig 5. Typical Capacitance Vs. Drain-to-Source Voltage

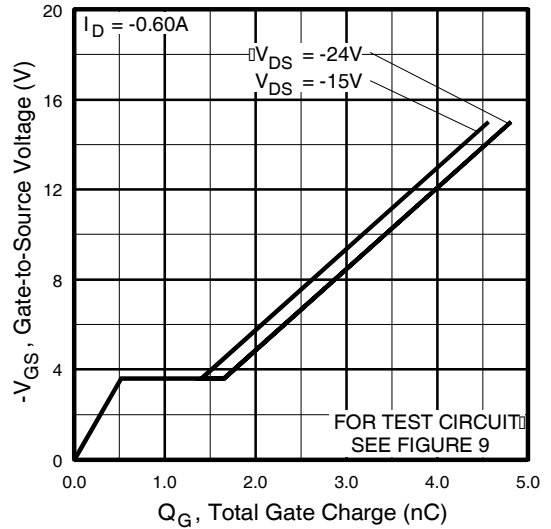

Fig 6. Typical Gate Charge Vs. Gate-to-Source Voltage

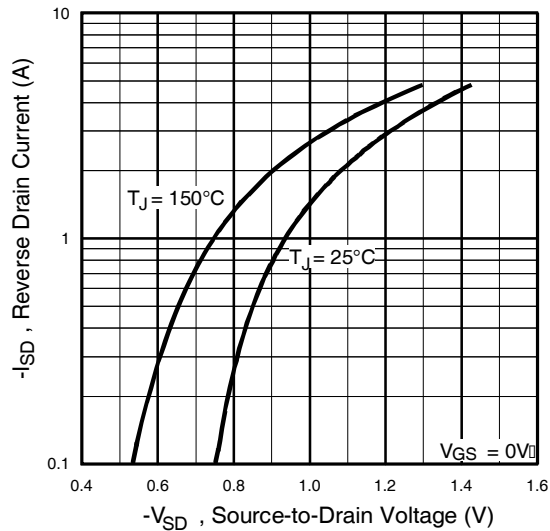

Fig 7. Typical Source-Drain Diode Forward Voltage

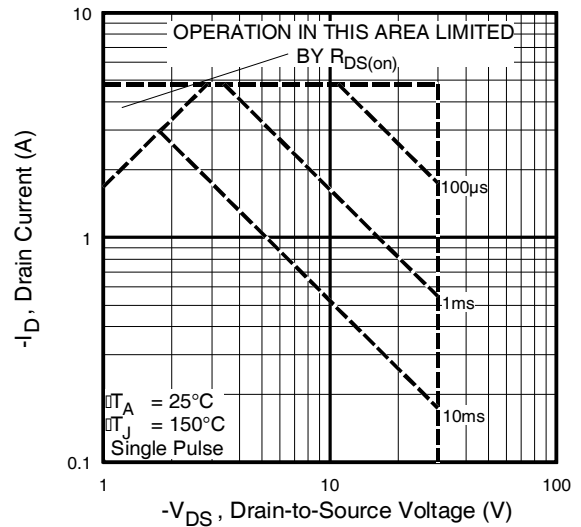
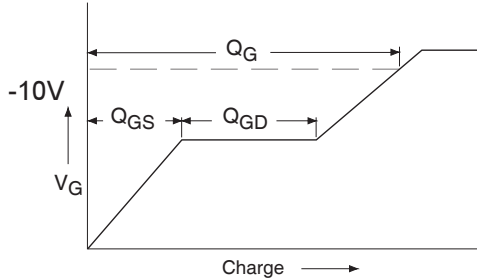
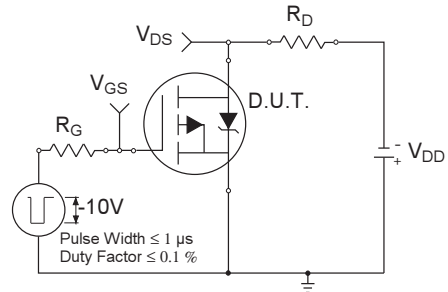
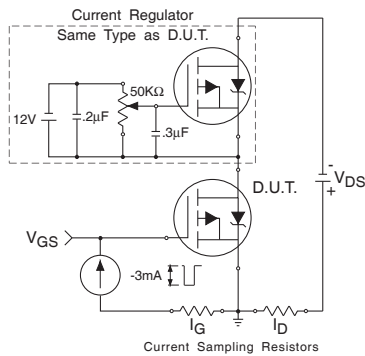
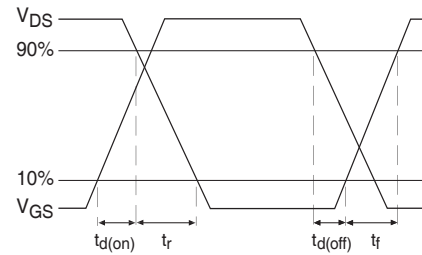
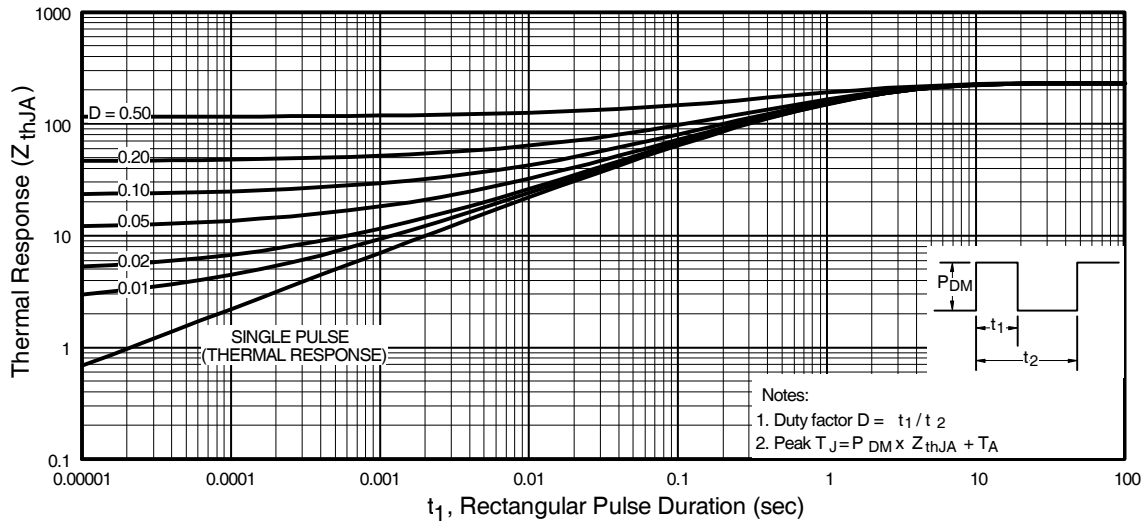
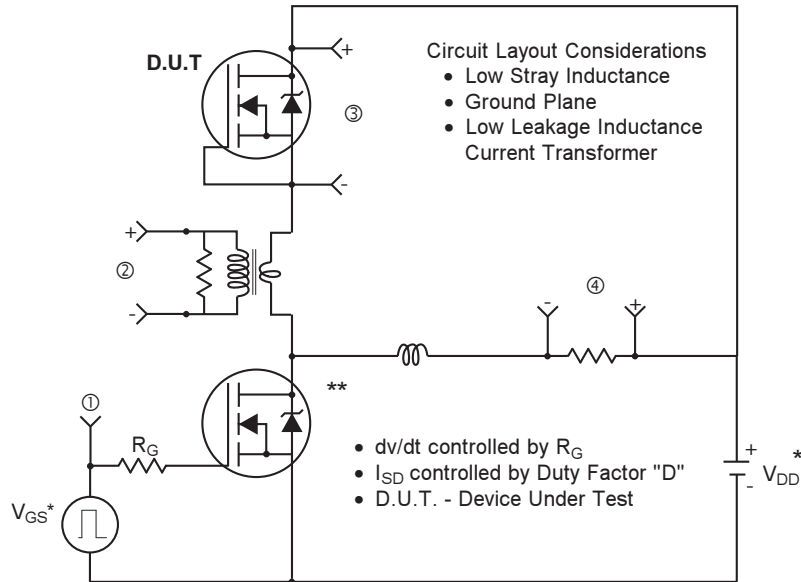

Fig 8. Maximum Safe Operating Area

Fig 9a. Basic Gate Charge Waveform

Fig 10a. Switching Time Test Circuit

Fig 9b. Gate Charge Test Circuit

Fig 10b. Switching Time Waveforms

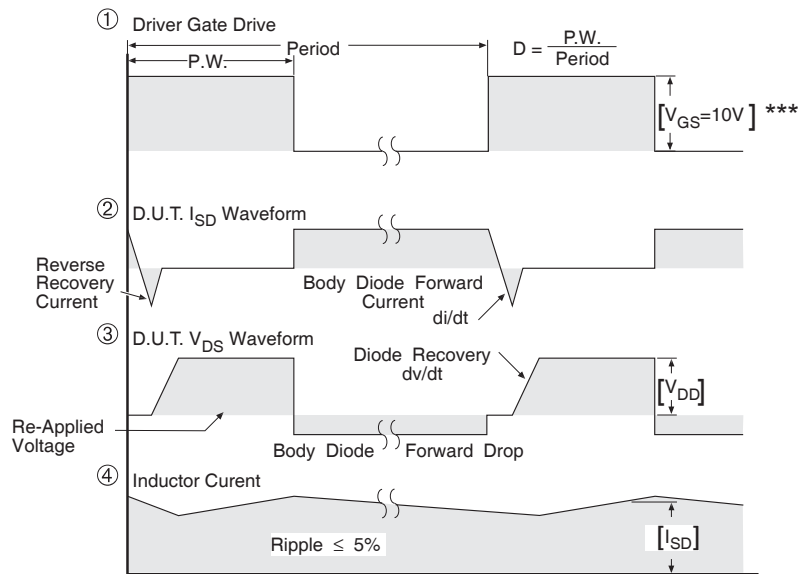
Fig 11. Maximum Effective Transient Thermal Impedance, Junction-to-Ambient

Peak Diode Recovery dv/dt Test Circuit

* Reverse Polarity for P-Channel

** Use P-Channel Driver for P-Channel Measurements



*** $V_{GS} = 5.0V$ for Logic Level and 3V Drive Devices

Fig 13. For P-Channel HEXFETS



Micro3 (SOT-23) (Lead-Free) Package Outline
 Dimensions are shown in millimeters (inches)

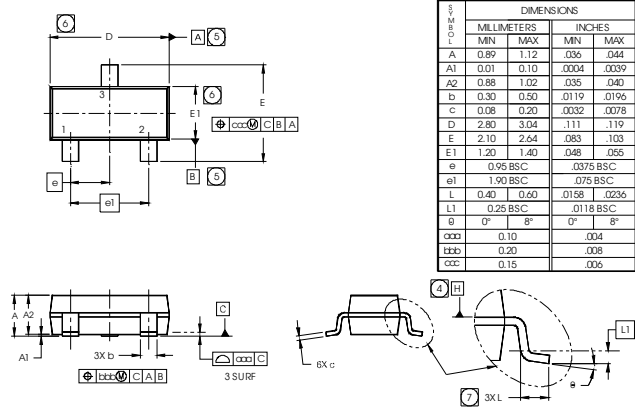

DIMENSIONS	DIMENSIONS			
	MILLIMETERS		INCHES	
	MIN	MAX	MIN	MAX
A	0.89	1.12	.035	.044
A1	0.01	0.10	.004	.0039
A2	0.88	1.02	.035	.040
b	0.30	0.50	.0119	.0196
c	0.08	0.20	.0032	.0078
D	2.80	3.04	.111	.119
E	2.10	2.64	.083	.103
E1	1.20	1.40	.048	.055
e	0.95 BSC		.0375 BSC	
e1	1.90 BSC		.075 BSC	
L	0.40	0.50	.0158	.0236
L1	0.25 BSC		.0118 BSC	
g	0"	8"	0"	8"
ccc	0.10		.004	
ttt	0.20		.008	
ccc	0.15		.005	

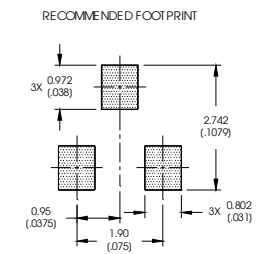

- NOTES
1. DIMENSIONING AND TOLERANCING PER ASME Y14.5M-1994.
 2. DIMENSIONS ARE SHOWN IN MILLIMETERS AND INCHES.
 3. CONTROLLING DIMENSION: MILLIMETER.
 4. DATUM PLANE H IS LOCATED AT THE MOLD PARTING LINE.
 5. DATUM A AND B TO BE DETERMINED AT DATUM PLANE H.
 6. DIMENSIONS D AND E1 ARE MEASURED AT DATUM PLANE H.
 7. DIMENSION L IS THE LEAD LENGTH FOR SOLDERING TO A SUBSTRATE.
 8. OUTLINE CONFORMS TO JEDEC OUTLINE TO-236AB.

Micro3 (SOT-23 / TO-236AB) Part Marking Information

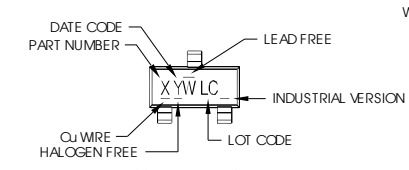

- X = PART NUMBER CODE REFERENCE:
- | | |
|---------------|---------------|
| A = IRLML2402 | S = IRLML6244 |
| B = IRLML2803 | T = IRLML6246 |
| C = IRLML6302 | U = IRLML6344 |
| D = IRLML5103 | V = IRLML6346 |
| E = IRLML6402 | W = IRFML8244 |
| F = IRLML6401 | X = IRLML2244 |
| G = IRLML2502 | Y = IRLML2246 |
| H = IRLML5203 | Z = IRFML9244 |
| I = IRLML0030 | |
| J = IRLML2030 | |
| K = IRLML0100 | |
| L = IRLML0060 | |
| M = IRLML0040 | |
| N = IRLML2060 | |
| P = IRLML9301 | |
| R = IRLML9303 | |

Note: A line above the work week (as shown here) indicates Lead-Free.

W = (1-26) IF PRECEDED BY LAST DIGIT OF CALENDAR YEAR

YEAR	Y	WORK WEEK	W
2011	2001	1 01	A
2012	2002	2 02	B
2013	2003	3 03	C
2014	2004	4 04	D
2015	2005	5	
2016	2006	6	
2017	2007	7	
2018	2008	8	
2019	2009	9	
2020	2010	0 24	X
		25	Y
		26	Z

W = (27-52) IF PRECEDED BY A LETTER

YEAR	Y	WORK WEEK	W
2011	2001	A 27	A
2012	2002	B 28	B
2013	2003	C 29	C
2014	2004	D 30	D
2015	2005	E	
2016	2006	F	
2017	2007	G	
2018	2008	H	
2019	2009	J	
2020	2010	K 50	X
		51	Y
		52	Z

Note: For the most current drawing please refer to IR website at <http://www.irf.com/package/>

Micro3™ Tape & Reel Information

Dimensions are shown in millimeters (inches)

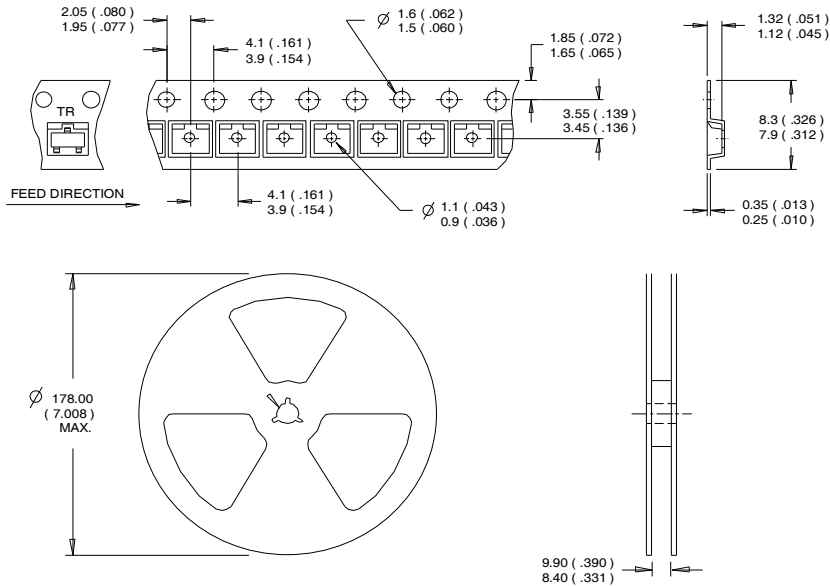

NOTES:
 1. CONTROLLING DIMENSION - MILLIMETER.
 2. OUTLINE CONFORMS TO EIA-481 & EIA-541.

Note: For the most current drawing please refer to IR website at <http://www.irf.com/package>

Qualification information[†]

Qualification level	Industrial (per JEDEC JESD47F ^{††} guidelines)	
Moisture Sensitivity Level	Micro3™ (SOT-23)	M5L1 (per JEDEC J-STD-020D ^{††})
RoHS compliant	Yes	

[†] Qualification standards can be found at International Rectifier's web site: <http://www.irf.com/product-info/reliability>

^{††} Applicable version of JEDEC standard at the time of product release

Revision History

Date	Comment
10/28/2014	• Updated partmarking to reflect Industrial partmarking on page 7.

International
 Rectifier

IR WORLD HEADQUARTERS: 101 N. Sepulveda Blvd., El Segundo, California 90245, USA
 To contact International Rectifier, please visit <http://www.irf.com/whoto-call/>