

IRG4IBC30UDPbF

INSULATED GATE BIPOLAR TRANSISTOR WITH ULTRAFAST SOFT RECOVERY DIODE UltraFast CoPack IGBT

Features

- 2.5kV, 60s insulation voltage ⑤
- 4.8 mm creepage distance to heatsink
- UltraFast: Optimized for high operating frequencies 8-40 kHz in hard switching, >200 kHz in resonant mode
- IGBT co-packaged with HEXFRED™ ultrafast, ultrasoft recovery antiparallel diodes
- Tighter parameter distribution
- Industry standard Isolated TO-220 Fullpak™ outline
- Lead-Free

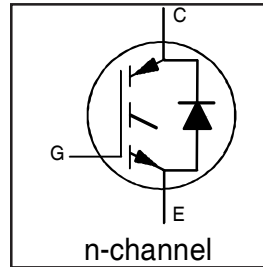

$V_{CES} = 600V$
$V_{CE(on) typ.} = 1.95V$
@ $V_{GE} = 15V, I_C = 12A$

Benefits

- Simplified assembly
- Highest efficiency and power density
- HEXFRED™ antiparallel Diode minimizes switching losses and EMI

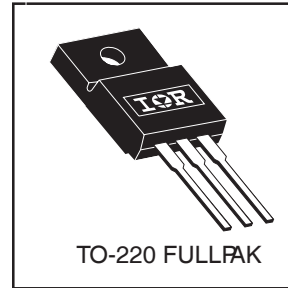

Absolute Maximum Ratings

	Parameter	Max.	Units
V_{CES}	Collector-to-Emitter Voltage	600	V
$I_C @ T_C = 25^\circ C$	Continuous Collector Current	17	A
$I_C @ T_C = 100^\circ C$	Continuous Collector Current	8.9	
I_{CM}	Pulsed Collector Current ①	68	
I_{LM}	Clamped Inductive Load Current ②	68	
$I_F @ T_C = 100^\circ C$	Diode Continuous Forward Current	8.5	
I_{FM}	Diode Maximum Forward Current	92	
V_{isol}	RMS Isolation Voltage, Terminal to Case ⑤	2500	V
V_{GE}	Gate-to-Emitter Voltage	± 20	
$P_D @ T_C = 25^\circ C$	Maximum Power Dissipation	45	W
$P_D @ T_C = 100^\circ C$	Maximum Power Dissipation	18	
T_J	Operating Junction and	-55 to +150	$^\circ C$
T_{STG}	Storage Temperature Range		
	Soldering Temperature, for 10 sec.	300 (0.063 in. (1.6mm) from case)	
	Mounting Torque, 6-32 or M3 Screw.	10 lbf•in (1.1 N•m)	

Thermal Resistance

	Parameter	Typ.	Max.	Units
$R_{\theta JC}$	Junction-to-Case - IGBT	—	2.8	$^\circ C/W$
$R_{\theta JC}$	Junction-to-Case - Diode	—	4.1	
$R_{\theta JA}$	Junction-to-Ambient, typical socket mount	—	65	
W_t	Weight	2.0 (0.07)	—	g (oz)

Electrical Characteristics @ T_J = 25°C (unless otherwise specified)

	Parameter	Min.	Typ.	Max.	Units	Conditions
V _{(BR)CES}	Collector-to-Emitter Breakdown Voltage _f	600	—	—	V	V _{GE} = 0V, I _C = 250μA
ΔV _{(BR)CES} /ΔT _J	Temperature Coeff. of Breakdown Voltage	—	0.63	—	V/°C	V _{GE} = 0V, I _C = 1.0mA
V _{CE(on)}	Collector-to-Emitter Saturation Voltage	—	1.95	2.1	V	I _C = 12A, V _{GE} = 15V
		—	2.52	—		I _C = 23A
		—	2.09	—		I _C = 12A, T _J = 150°C
V _{GE(th)}	Gate Threshold Voltage	3.0	—	6.0		V _{CE} = V _{GE} , I _C = 250μA
ΔV _{GE(th)} /ΔT _J	Temperature Coeff. of Threshold Voltage	—	-11	—	mV/°C	V _{CE} = V _{GE} , I _C = 250μA
g _{fe}	Forward Transconductance [Ⓢ]	3.1	8.6	—	S	V _{CE} = 100V, I _C = 12A
I _{CES}	Zero Gate Voltage Collector Current	—	—	250	μA	V _{GE} = 0V, V _{CE} = 600V
		—	—	2500		V _{GE} = 0V, V _{CE} = 600V, T _J = 150°C
V _{FM}	Diode Forward Voltage Drop	—	1.4	1.7	V	I _C = 12A
		—	1.3	1.6		I _C = 12A, T _J = 150°C
I _{GES}	Gate-to-Emitter Leakage Current	—	—	±100	nA	V _{GE} = ±20V

Switching Characteristics @ T_J = 25°C (unless otherwise specified)

	Parameter	Min.	Typ.	Max.	Units	Conditions
Q _g	Total Gate Charge (turn-on)	—	50	75	nC	I _C = 12A
Q _{ge}	Gate - Emitter Charge (turn-on)	—	8.1	12		V _{CC} = 400V
Q _{gc}	Gate - Collector Charge (turn-on)	—	18	27		V _{GE} = 15V
t _{d(on)}	Turn-On Delay Time	—	40	—	ns	T _J = 25°C
t _r	Rise Time	—	21	—		I _C = 12A, V _{CC} = 480V
t _{d(off)}	Turn-Off Delay Time	—	91	140		V _{GE} = 15V, R _G = 23Ω
t _f	Fall Time	—	80	130		Energy losses include "tail" and diode reverse recovery.
E _{on}	Turn-On Switching Loss	—	0.38	—	mJ	See Fig. 9, 10, 11, 18
E _{off}	Turn-Off Switching Loss	—	0.16	—		
E _{ts}	Total Switching Loss	—	0.54	0.9		
t _{d(on)}	Turn-On Delay Time	—	40	—	ns	T _J = 150°C, See Fig. 9, 10, 11, 18
t _r	Rise Time	—	22	—		I _C = 12A, V _{CC} = 480V
t _{d(off)}	Turn-Off Delay Time	—	120	—		V _{GE} = 15V, R _G = 23Ω
t _f	Fall Time	—	180	—		Energy losses include "tail" and diode reverse recovery.
E _{ts}	Total Switching Loss	—	0.89	—	mJ	
L _E	Internal Emitter Inductance	—	7.5	—	nH	Measured 5mm from package
C _{ies}	Input Capacitance	—	1100	—	pF	V _{GE} = 0V
C _{oes}	Output Capacitance	—	73	—		V _{CC} = 30V
C _{res}	Reverse Transfer Capacitance	—	14	—		f = 1.0MHz
t _{rr}	Diode Reverse Recovery Time	—	42	60	ns	T _J = 25°C See Fig. 14
		—	80	120		T _J = 125°C
I _{rr}	Diode Peak Reverse Recovery Current	—	3.5	6.0	A	T _J = 25°C See Fig. 15
		—	5.6	10		T _J = 125°C
Q _{rr}	Diode Reverse Recovery Charge	—	80	180	nC	T _J = 25°C See Fig. 16
		—	220	600		T _J = 125°C
di _(rec) M/dt	Diode Peak Rate of Fall of Recovery During t _b	—	180	—	A/μs	T _J = 25°C See Fig. 17
		—	120	—		T _J = 125°C

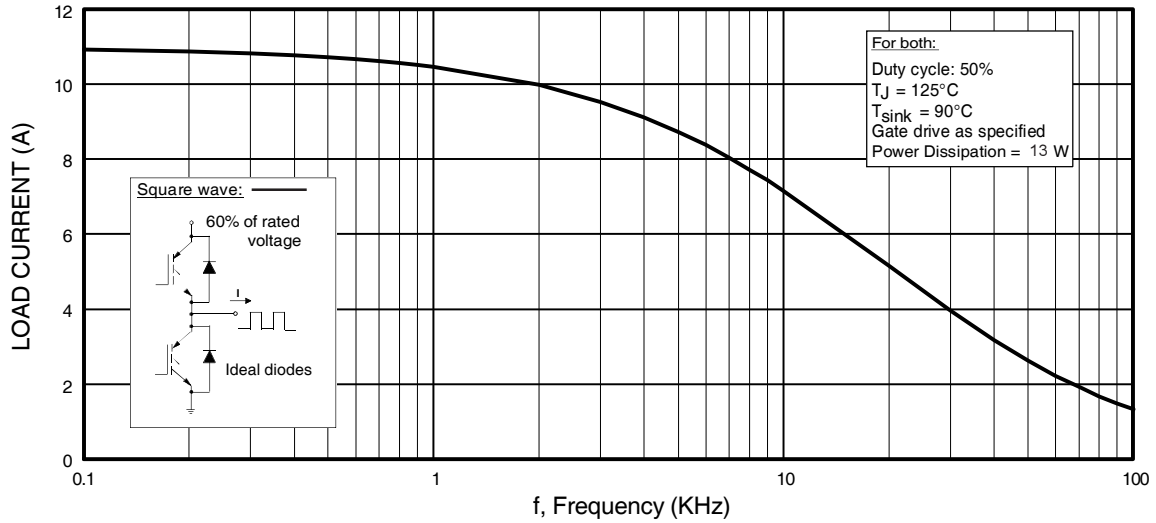

Fig. 1 - Typical Load Current vs. Frequency
 (Load Current = I_{RMS} of fundamental)

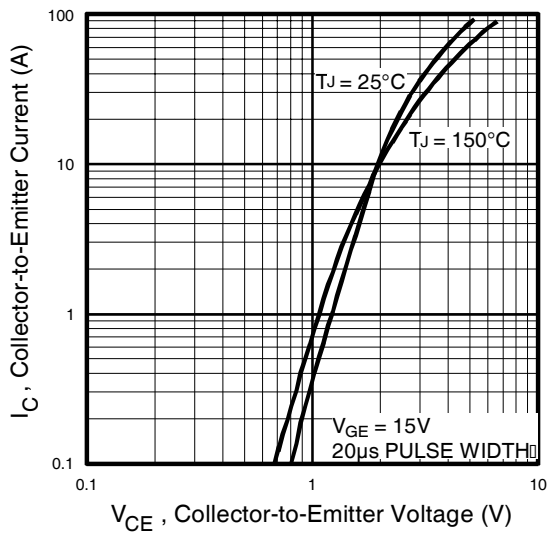

Fig. 2 - Typical Output Characteristics
www.irf.com

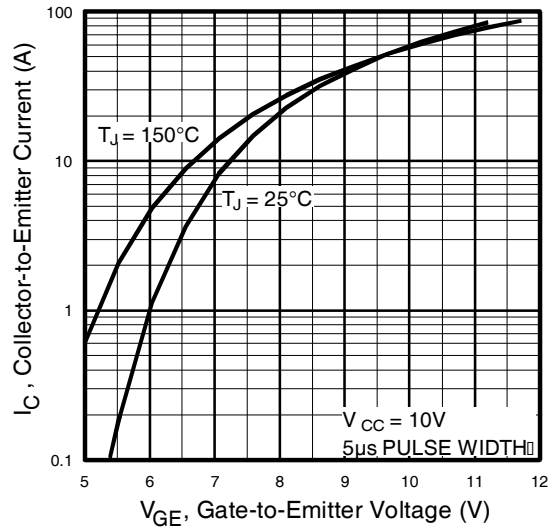

Fig. 3 - Typical Transfer Characteristics

IRG4IBC30UDPbF

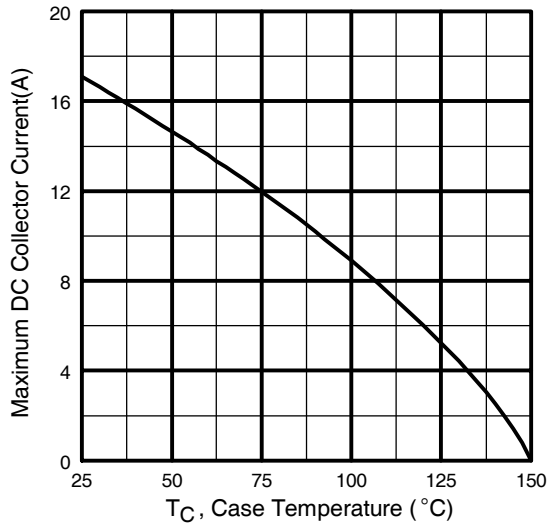

Fig. 4 - Maximum Collector Current vs. Case Temperature

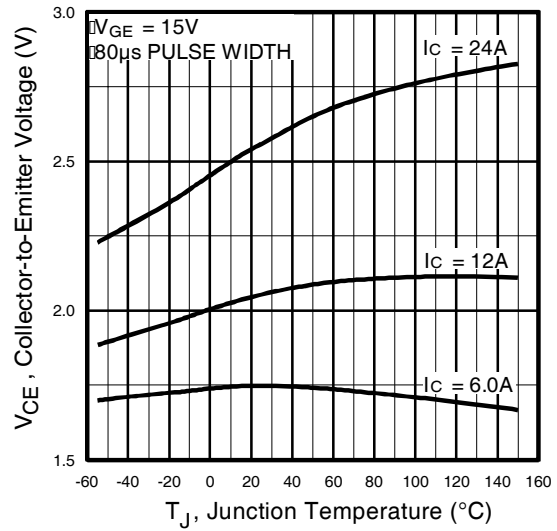

Fig. 5 - Typical Collector-to-Emitter Voltage vs. Junction Temperature

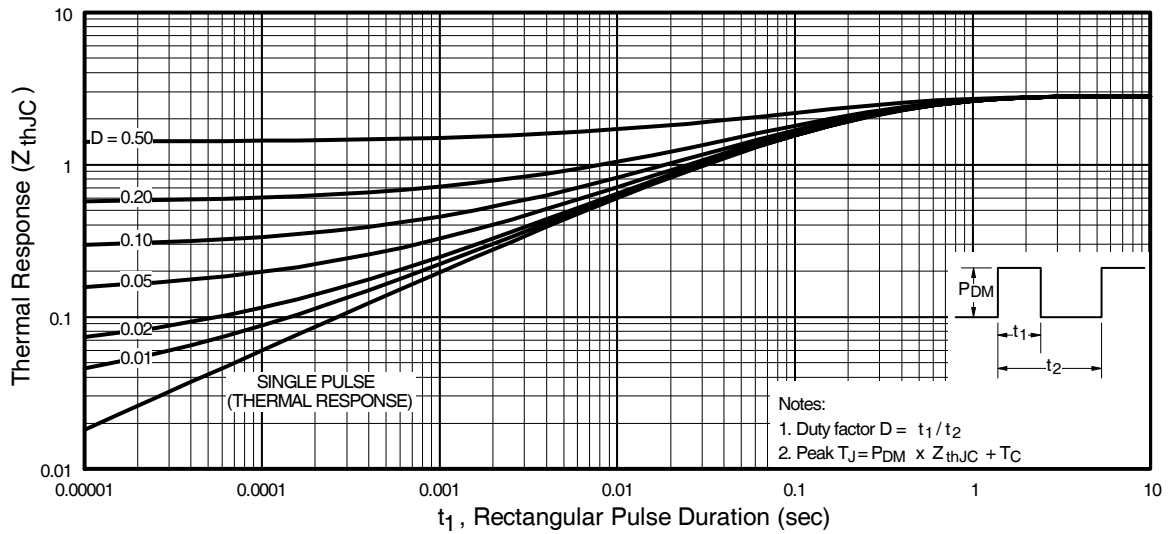

Fig. 6 - Maximum IGBT Effective Transient Thermal Impedance, Junction-to-Case

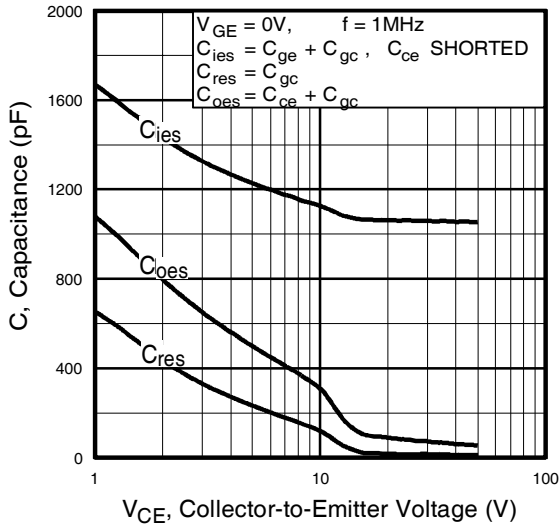

Fig. 7 - Typical Capacitance vs. Collector-to-Emitter Voltage

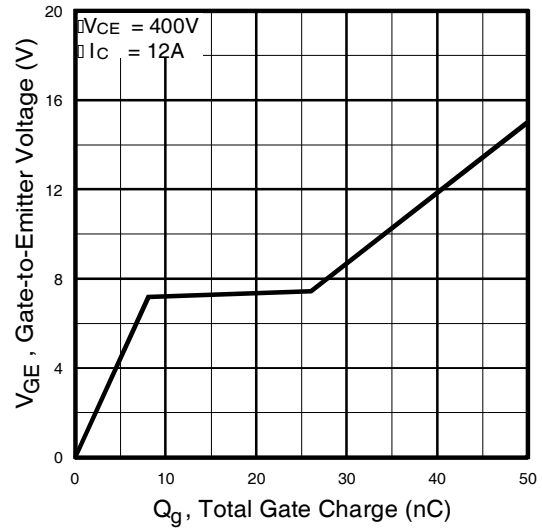

Fig. 8 - Typical Gate Charge vs. Gate-to-Emitter Voltage

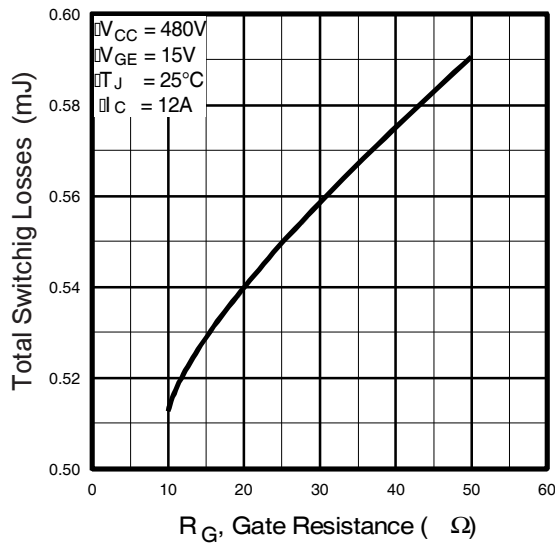

Fig. 9 - Typical Switching Losses vs. Gate Resistance

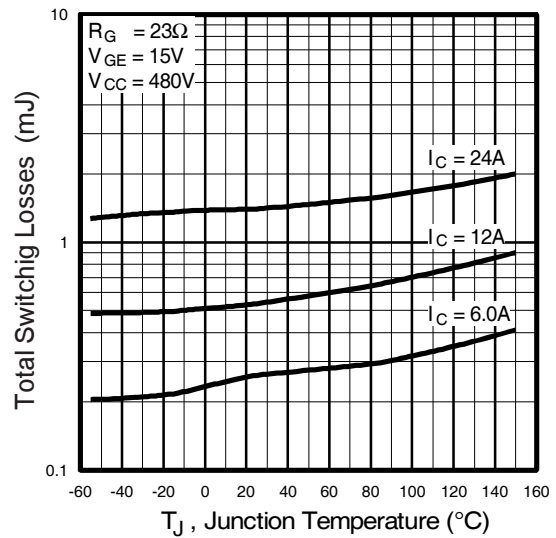

Fig. 10 - Typical Switching Losses vs. Junction Temperature

IRG4IBC30UDPbF

International
IR Rectifier

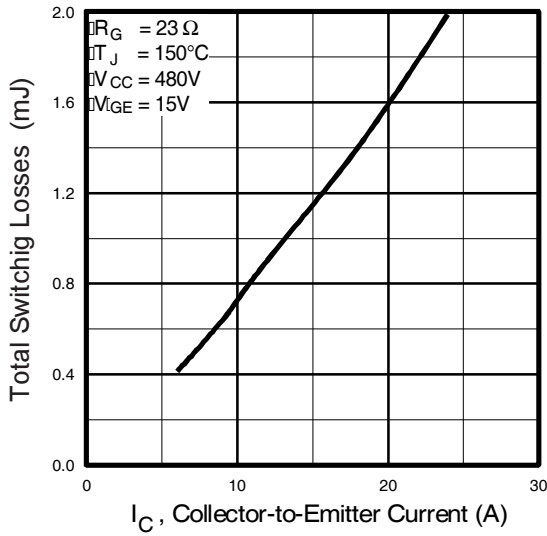

Fig. 11 - Typical Switching Losses vs. Collector-to-Emitter Current

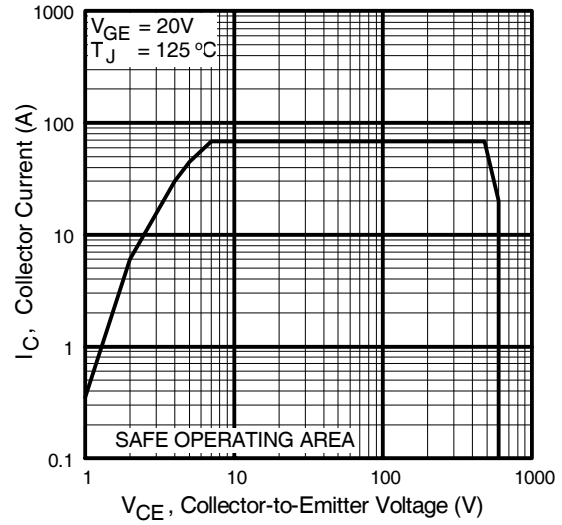

Fig. 12 - Turn-Off SOA

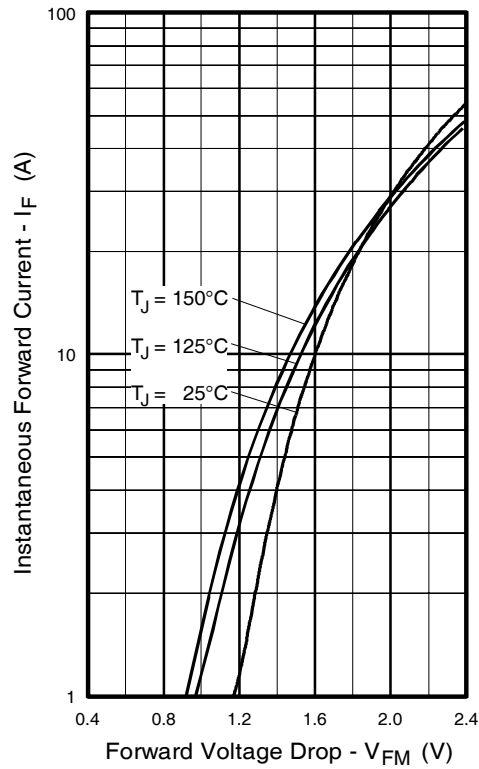

Fig. 13 - Maximum Forward Voltage Drop vs. Instantaneous Forward Current

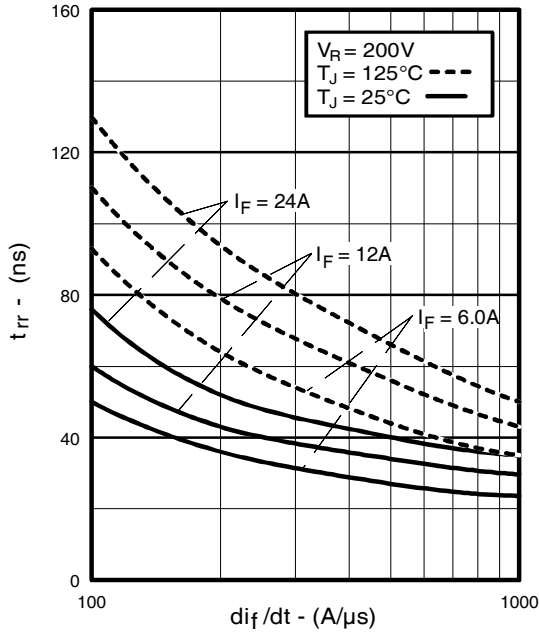

Fig. 14 - Typical Reverse Recovery vs. di_f/dt

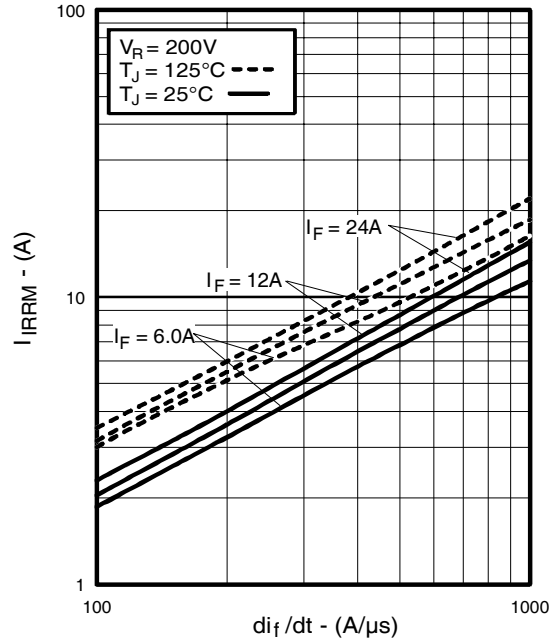

Fig. 15 - Typical Recovery Current vs. di_f/dt

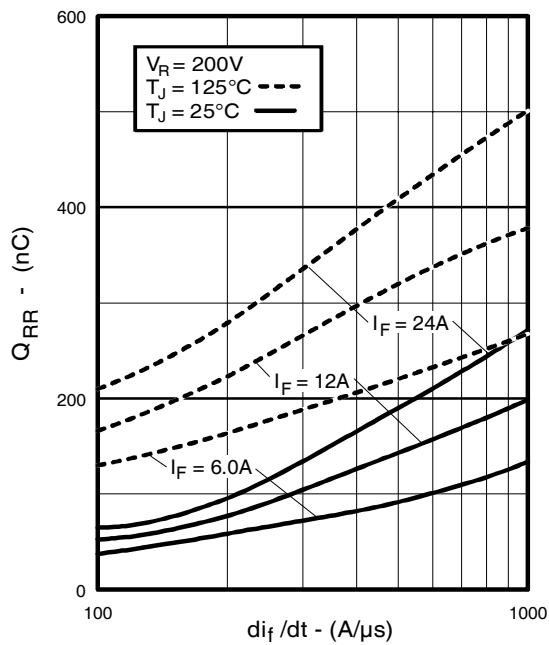

Fig. 16 - Typical Stored Charge vs. di_f/dt

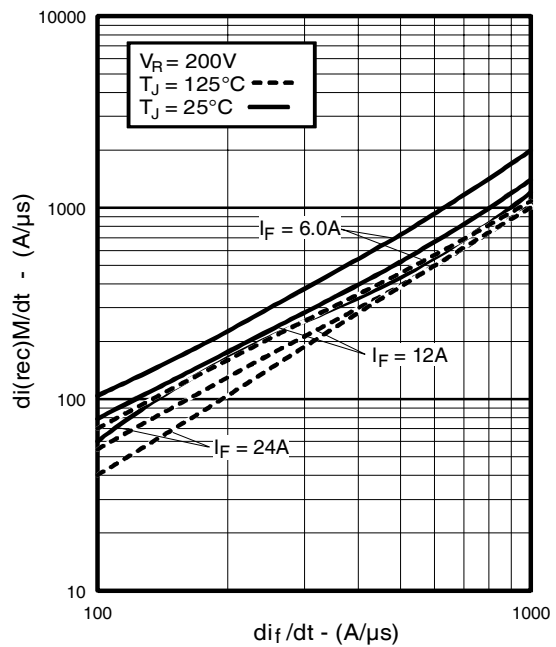

Fig. 17 - Typical $di_{(rec)M}/dt$ vs. di_f/dt

IRG4IBC30UDPbF



Fig. 18a - Test Circuit for Measurement of I_{LM} , E_{on} , $E_{off}(\text{diode})$, t_{rr} , Q_{rr} , I_{rr} , $t_{d(on)}$, t_r , $t_{d(off)}$, t_f

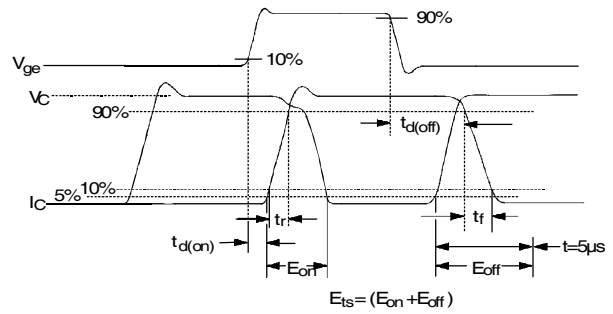

Fig. 18b - Test Waveforms for Circuit of Fig. 18a, Defining E_{off} , $t_{d(off)}$, t_f

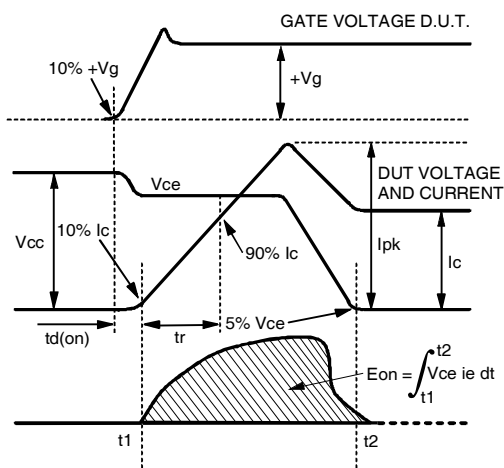

Fig. 18c - Test Waveforms for Circuit of Fig. 18a, Defining E_{on} , $t_{d(on)}$, t_r

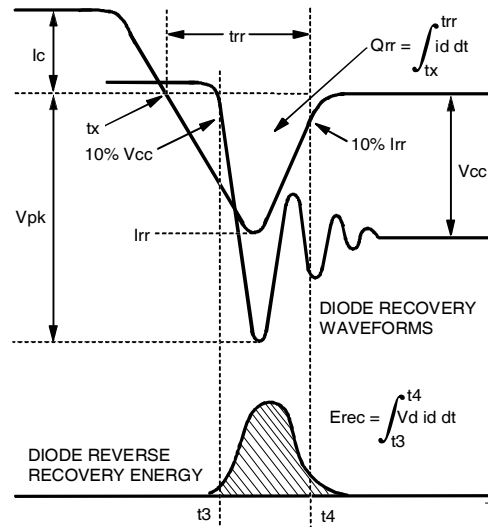

Fig. 18d - Test Waveforms for Circuit of Fig. 18a, Defining E_{rec} , t_{rr} , Q_{rr} , I_{rr}

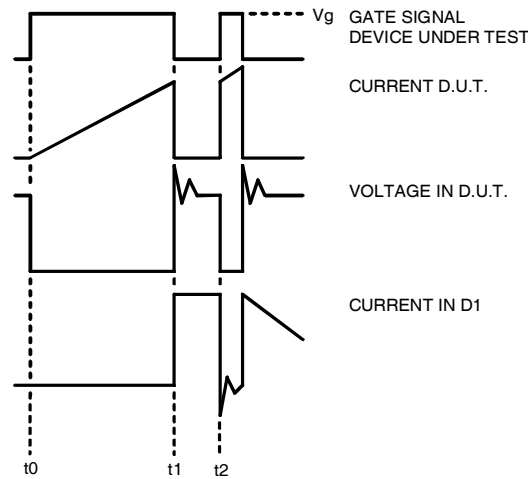

Figure 18e. Macro Waveforms for Figure 18a's Test Circuit

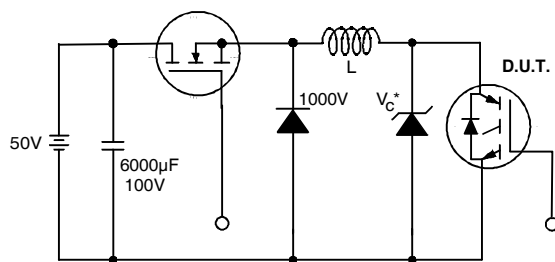

Figure 19. Clamped Inductive Load Test Circuit

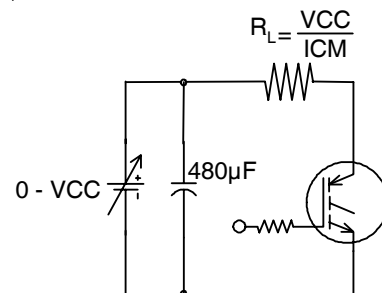

Figure 20. Pulsed Collector Current Test Circuit

IRG4IBC30UDPbF

TO-220AB Full-Pak Package Outline

Dimensions are shown in millimeters (inches)

International
IR Rectifier

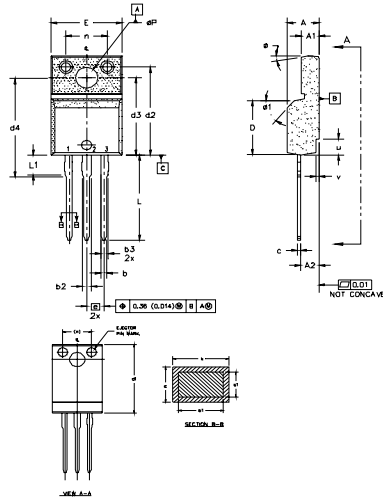

NOTES:
1.0 DIMENSIONS AND TOLERANCING PER ASME Y14.5 M-1994.
2.0 DIMENSIONS ARE SHOWN IN MILLIMETERS (INCHES).
3.0 LEAD DIMENSION AND FINISH UNCONTROLLED AT L1.
4.0 DIMENSION D & E DO NOT INCLUDE MOLD FLASH; MOLD FLASH SHALL NOT EXCEED 0.025" (0.127) PER SIDE. THESE DIMENSIONS ARE MEASURED AT THE OUTERMOST EXTREMES OF THE PLASTIC BODY.
5.0 DIMENSION H APPLYS TO BASE METAL ONLY.
6.0 STEP OPTIONAL ON PLASTIC BODY DEFINED BY DIMENSIONS U & V.
7.0 CONTROLLING DIMENSION - INCHES.

SYMBOL	MILLIMETERS		INCHES		NOTES	LEAD ASSIGNMENTS
	MIN	MAX	MIN	MAX		
A	4.37	4.83	0.180	0.190		
A1	2.57	2.85	0.101	0.114		
A2	2.51	2.85	0.099	0.112		
b	0.622	0.89	0.024	0.035		
b1	0.622	0.828	0.024	0.032	0	1- GATE 2- DRAIN 3- SOURCE
b2	1.229	1.400	0.048	0.055		
b3	1.229	1.400	0.048	0.055		
c	0.440	0.629	0.017	0.025		
c1	0.440	0.506	0.017	0.020		
D	8.65	9.80	0.341	0.386	4	IRF1840G 1- GATE 2- COLLECTOR 3- EMITTER
d1	19.80	19.15	0.783	0.753		
d2	19.97	14.22	0.786	0.560		
d3	12.30	12.97	0.484	0.509		
d4	8.64	9.81	0.340	0.390		
E	10.36	10.63	0.408	0.419	4	
e	2.54	2.54	0.100	0.100		
L	13.20	13.73	0.520	0.541		
L1	3.10	3.50	0.122	0.138	3	
n	6.05	6.15	0.238	0.242		
np	3.05	3.40	0.120	0.136		
u	2.40	2.50	0.094	0.098	6	
v	0.40	0.50	0.016	0.020	6	
φ	3"	3"	3"	3"		
φ1	45°	45°	45°	45°		

TO-220 Full-Pak Part Marking Information

EXAMPLE: THIS IS AN IRF1840G
WITH ASSEMBLY
LOT CODE 3432
ASSEMBLED ON WW 24 1999
IN THE ASSEMBLY LINE 'K'

Note: "P" in assembly line position indicates "Lead-Free"

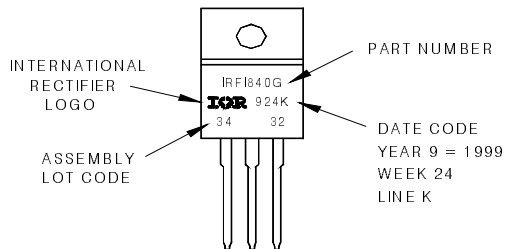

Note: For the most current drawing please refer to IR website at <http://www.irf.com/package/>

Notes:

- ① Repetitive rating: $V_{GE}=20V$; pulse width limited by maximum junction temperature (figure 20)
- ② $V_{CC}=80\%(V_{CES})$, $V_{GE}=20V$, $L=10\mu H$, $R_G=23\Omega$ (figure 19)
- ③ Pulse width $\leq 80\mu s$; duty factor $\leq 0.1\%$.
- ④ Pulse width $5.0\mu s$, single shot.
- ⑤ $t = 60s$, $f = 60Hz$

Data and specifications subject to change without notice.

International
IR Rectifier

IR WORLD HEADQUARTERS: 233 Kansas St., El Segundo, California 90245, USA Tel: (310) 252-7105

TAC Fax: (310) 252-7903

Visit us at www.irf.com for sales contact information.06/2010

www.irf.com