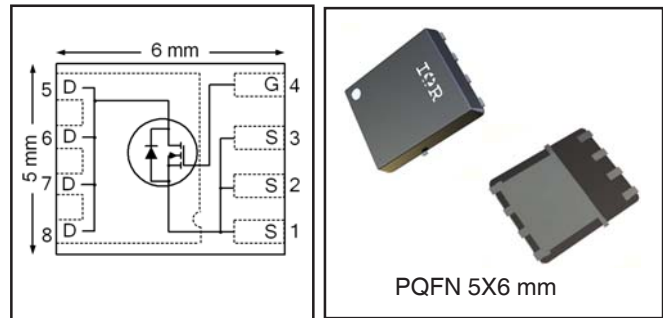


HEXFET® Power MOSFET

$V_{DS}$	<b>30</b>	<b>V</b>
$V_{GS\ max}$	<b>± 20</b>	<b>V</b>
$R_{DS(on)\ max}$ (@ $V_{GS} = 10V$ )	<b>12.8</b>	<b>mΩ</b>
(@ $V_{GS} = 4.5V$ )	<b>19.9</b>	
$Q_g\ typ.$	<b>4.7</b>	<b>nC</b>
$I_D$ (@ $T_{c(Bottom)} = 25^\circ C$ )	<b>16.2</b> Ⓣ	<b>A</b>



**Applications**

- Control MOSFET for high frequency buck converters

**Features and Benefits**

**Features**

Low Thermal Resistance to PCB (< 4.7°C/W)
Low Profile (< 1.2mm)
Industry-Standard Pinout
Compatible with Existing Surface Mount Techniques
RoHS Compliant Containing no Lead, no Bromide and no Halogen
MSL1, Consumer Qualification

results in



**Benefits**

Enable better thermal dissipation
Increased Power Density
Multi-Vendor Compatibility
Easier Manufacturing
Environmentally Friendlier
Increased Reliability

Orderable part number	Package Type	Standard Pack		Note
		Form	Quantity	
IRFH8337TRPBF	PQFN 5mm x 6mm	Tape and Reel	4000	
IRFH8337TR2PBF	PQFN 5mm x 6mm	Tape and Reel	400	EOL notice #259

**Absolute Maximum Ratings**

	Parameter	Max.	Units
$V_{DS}$	Drain-to-Source Voltage	30	V
$V_{GS}$	Gate-to-Source Voltage	± 20	
$I_D @ T_A = 25^\circ C$	Continuous Drain Current, $V_{GS} @ 10V$	12	A
$I_D @ T_A = 70^\circ C$	Continuous Drain Current, $V_{GS} @ 10V$	9.7	
$I_D @ T_{c(Bottom)} = 25^\circ C$	Continuous Drain Current, $V_{GS} @ 10V$	35 Ⓣ	
$I_D @ T_{c(Bottom)} = 100^\circ C$	Continuous Drain Current, $V_{GS} @ 10V$	22 Ⓣ	
$I_D @ T_C = 25^\circ C$	Continuous Drain Current, $V_{GS} @ 10V$ (Source Bonding Technology Limited)	16.2 Ⓣ	
$I_{DM}$	Pulsed Drain Current ①	65	
$P_D @ T_A = 25^\circ C$	Power Dissipation ②	3.2	W
$P_D @ T_{c(Bottom)} = 25^\circ C$	Power Dissipation ②	27	
	Linear Derating Factor ③	0.026	W/°C
$T_J$	Operating Junction and	-55 to + 150	°C
$T_{STG}$	Storage Temperature Range		

Notes ① through ③ are on page 9

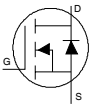
**Static @ T<sub>J</sub> = 25°C (unless otherwise specified)**

	Parameter	Min.	Typ.	Max.	Units	Conditions
B <sub>V</sub> DSS	Drain-to-Source Breakdown Voltage	30	—	—	V	V <sub>GS</sub> = 0V, I <sub>D</sub> = 250μA
ΔB <sub>V</sub> DSS/ΔT <sub>J</sub>	Breakdown Voltage Temp. Coefficient	—	0.025	—	V/°C	Reference to 25°C, I <sub>D</sub> = 1.0mA
R <sub>DS(on)</sub>	Static Drain-to-Source On-Resistance	—	10.3	12.8	mΩ	V <sub>GS</sub> = 10V, I <sub>D</sub> = 16.2A ③
		—	15.8	19.9		V <sub>GS</sub> = 4.5V, I <sub>D</sub> = 13A ③
V <sub>GS(th)</sub>	Gate Threshold Voltage	1.35	1.8	2.35	V	V <sub>DS</sub> = V <sub>GS</sub> , I <sub>D</sub> = 25μA
ΔV <sub>GS(th)</sub>	Gate Threshold Voltage Coefficient	—	-6.0	—	mV/°C	
I <sub>DSS</sub>	Drain-to-Source Leakage Current	—	—	1.0	μA	V <sub>DS</sub> = 24V, V <sub>GS</sub> = 0V
		—	—	150		V <sub>DS</sub> = 24V, V <sub>GS</sub> = 0V, T <sub>J</sub> = 125°C
I <sub>GSS</sub>	Gate-to-Source Forward Leakage	—	—	100	nA	V <sub>GS</sub> = 20V
	Gate-to-Source Reverse Leakage	—	—	-100		V <sub>GS</sub> = -20V
g <sub>fs</sub>	Forward Transconductance	31	—	—	S	V <sub>DS</sub> = 10V, I <sub>D</sub> = 16.2A
Q <sub>g</sub>	Total Gate Charge	—	10	—	nC	V <sub>GS</sub> = 10V, V <sub>DS</sub> = 15V, I <sub>D</sub> = 16.2A
Q <sub>g</sub>	Total Gate Charge	—	4.7	—	nC	V <sub>DS</sub> = 15V V <sub>GS</sub> = 4.5V I <sub>D</sub> = 16.2A
Q <sub>gs1</sub>	Pre-V <sub>th</sub> Gate-to-Source Charge	—	1.6	—		
Q <sub>gs2</sub>	Post-V <sub>th</sub> Gate-to-Source Charge	—	0.7	—		
Q <sub>gd</sub>	Gate-to-Drain Charge	—	1.4	—		
Q <sub>godr</sub>	Gate Charge Overdrive	—	1.0	—		
Q <sub>sw</sub>	Switch Charge (Q <sub>gs2</sub> + Q <sub>gd</sub> )	—	2.1	—	nC	V <sub>DS</sub> = 16V, V <sub>GS</sub> = 0V
Q <sub>oss</sub>	Output Charge	—	4.2	—		
R <sub>G</sub>	Gate Resistance	—	1.6	—	Ω	
t <sub>d(on)</sub>	Turn-On Delay Time	—	6.4	—	ns	V <sub>DD</sub> = 15V, V <sub>GS</sub> = 4.5V I <sub>D</sub> = 16.2A R <sub>G</sub> = 1.8Ω
t <sub>r</sub>	Rise Time	—	12	—		
t <sub>d(off)</sub>	Turn-Off Delay Time	—	5.7	—		
t <sub>f</sub>	Fall Time	—	4.1	—		
C <sub>iss</sub>	Input Capacitance	—	790	—	pF	V <sub>GS</sub> = 0V V <sub>DS</sub> = 10V f = 1.0MHz
C <sub>oss</sub>	Output Capacitance	—	180	—		
C <sub>rss</sub>	Reverse Transfer Capacitance	—	69	—		

**Avalanche Characteristics**

	Parameter	Typ.	Max.	Units
E <sub>AS</sub>	Single Pulse Avalanche Energy ②	—	28	mJ
I <sub>AR</sub>	Avalanche Current ①	—	16.2	A

**Diode Characteristics**

	Parameter	Min.	Typ.	Max.	Units	Conditions
I <sub>S</sub>	Continuous Source Current (Body Diode)	—	—	16.2	A	MOSFET symbol showing the integral reverse p-n junction diode. 
I <sub>SM</sub>	Pulsed Source Current (Body Diode) ①	—	—	65		
V <sub>SD</sub>	Diode Forward Voltage	—	—	1.0	V	T <sub>J</sub> = 25°C, I <sub>S</sub> = 16.2A, V <sub>GS</sub> = 0V ③
t <sub>rr</sub>	Reverse Recovery Time	—	12	18	ns	T <sub>J</sub> = 25°C, I <sub>F</sub> = 16.2A, V <sub>DD</sub> = 15V
Q <sub>rr</sub>	Reverse Recovery Charge	—	17	26	nC	di/dt = 390 A/μs ③
t <sub>on</sub>	Forward Turn-On Time	Time is dominated by parasitic inductance				

**Thermal Resistance**

	Parameter	Typ.	Max.	Units
R <sub>θJC</sub> (Bottom)	Junction-to-Case ④	—	4.7	°C/W
R <sub>θJC</sub> (Top)	Junction-to-Case ④	—	40	
R <sub>θJA</sub>	Junction-to-Ambient ⑤	—	39	
R <sub>θJA</sub> (<10s)	Junction-to-Ambient ⑤	—	26	

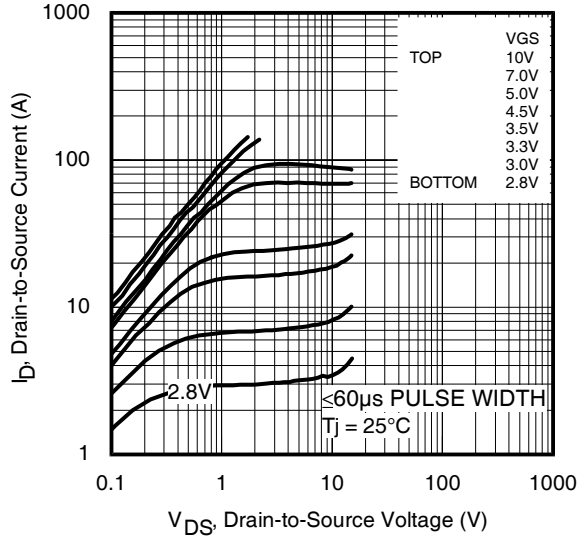


Fig 1. Typical Output Characteristics

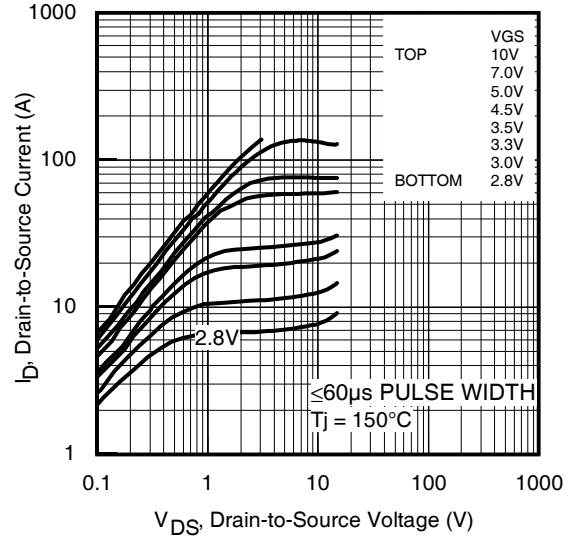


Fig 2. Typical Output Characteristics

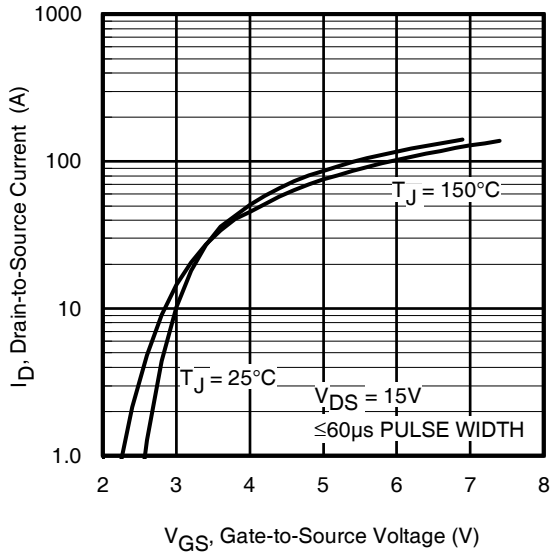


Fig 3. Typical Transfer Characteristics

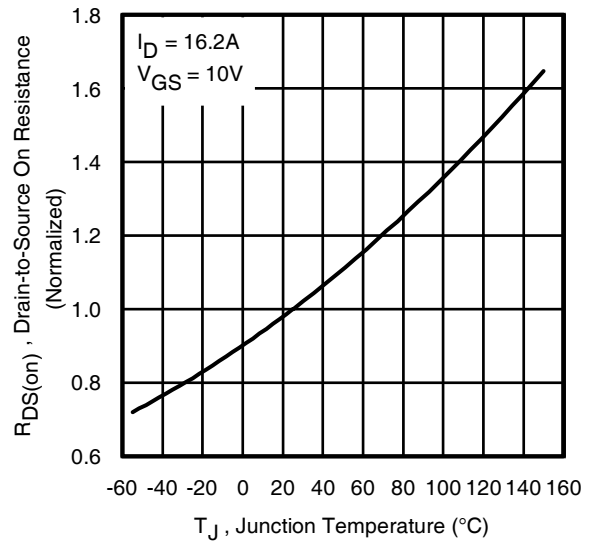


Fig 4. Normalized On-Resistance vs. Temperature

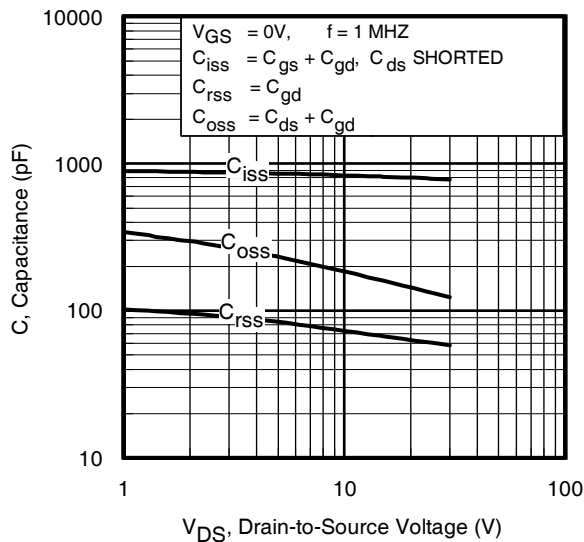


Fig 5. Typical Capacitance vs. Drain-to-Source Voltage

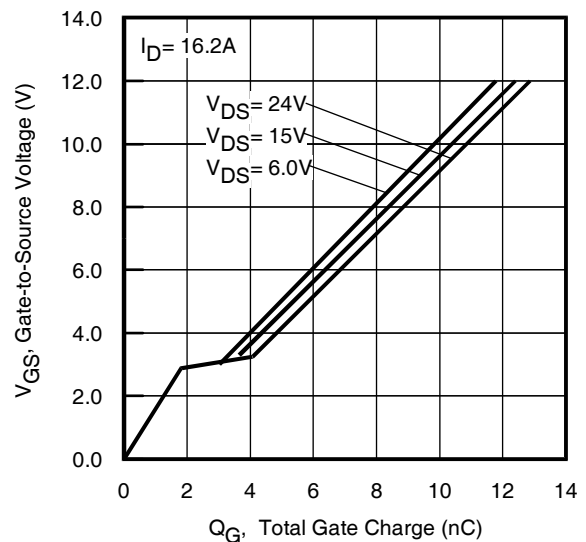


Fig 6. Typical Gate Charge vs. Gate-to-Source Voltage

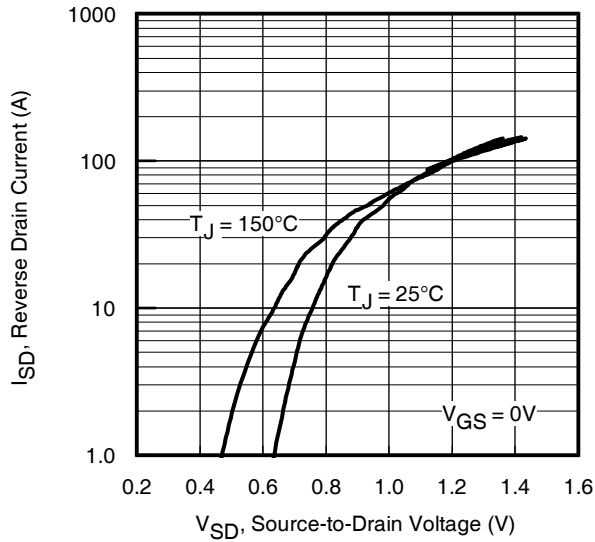


Fig 7. Typical Source-Drain Diode Forward Voltage

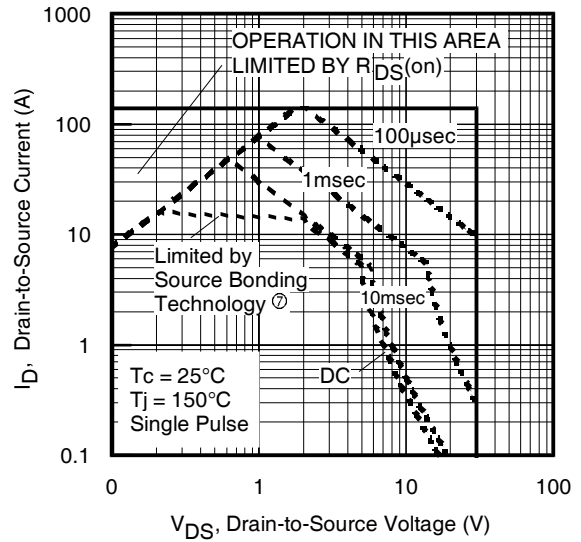


Fig 8. Maximum Safe Operating Area

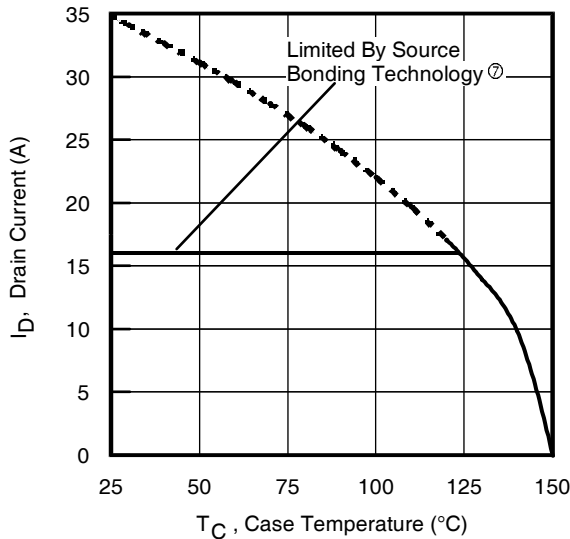


Fig 9. Maximum Drain Current vs. Case (Bottom) Temperature

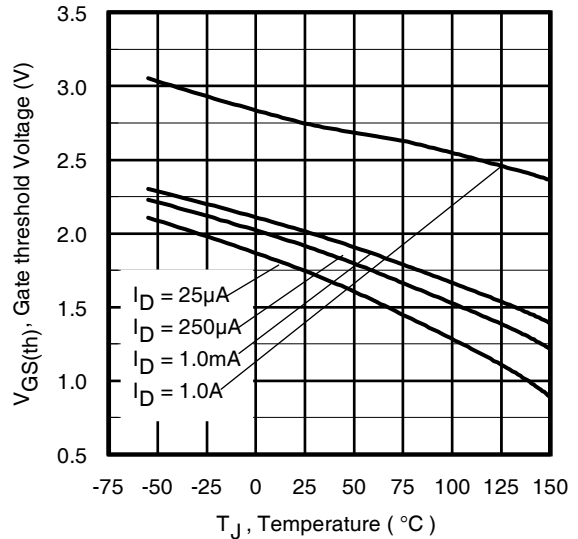


Fig 10. Threshold Voltage vs. Temperature

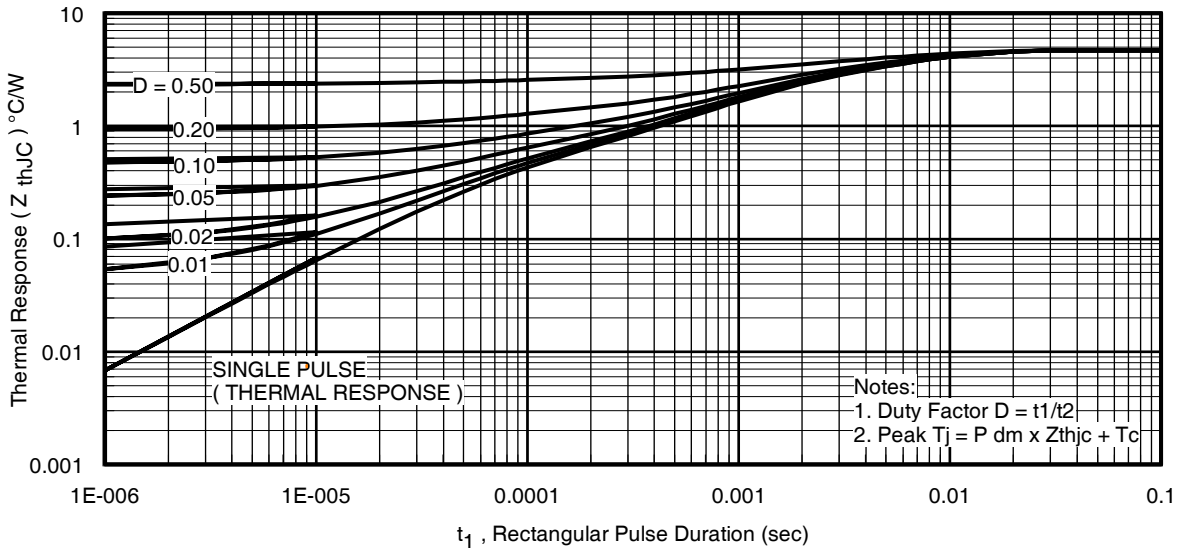
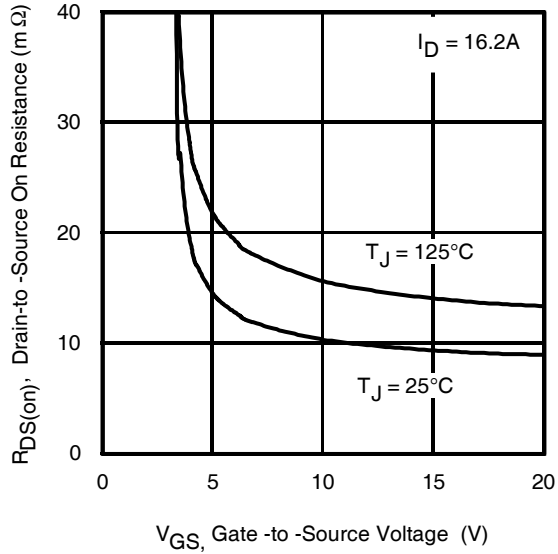
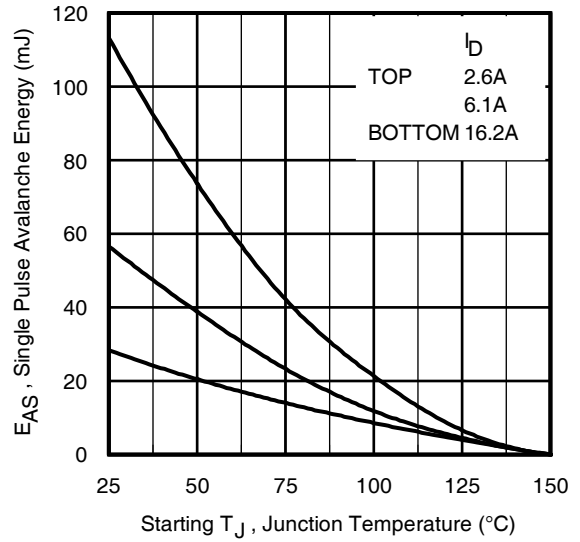


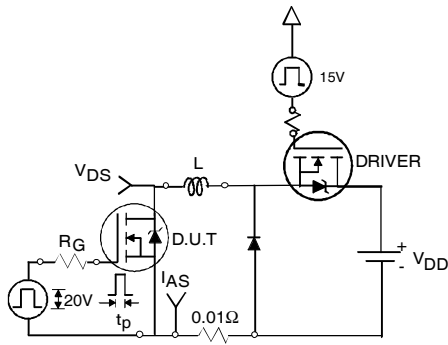
Fig 11. Maximum Effective Transient Thermal Impedance, Junction-to-Case (Bottom)



**Fig 12.** On-Resistance vs. Gate Voltage



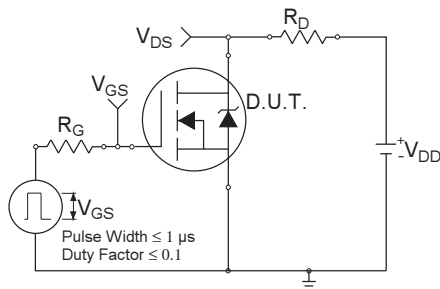
**Fig 13.** Maximum Avalanche Energy vs. Drain Current



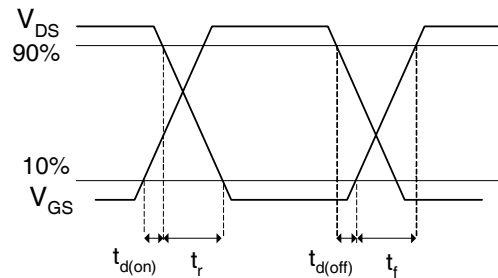
**Fig 14a.** Unclamped Inductive Test Circuit



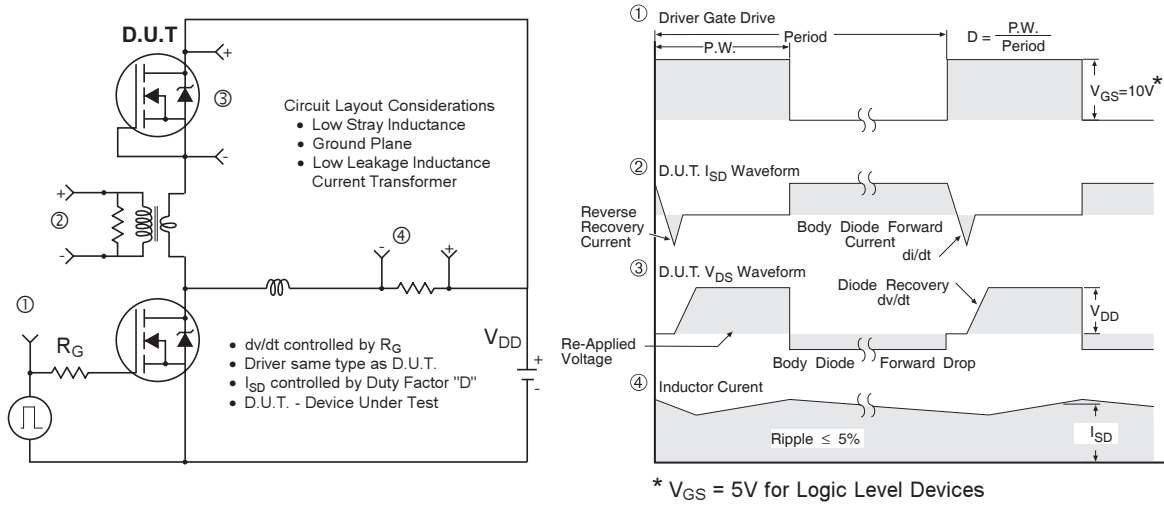
**Fig 14b.** Unclamped Inductive Waveforms



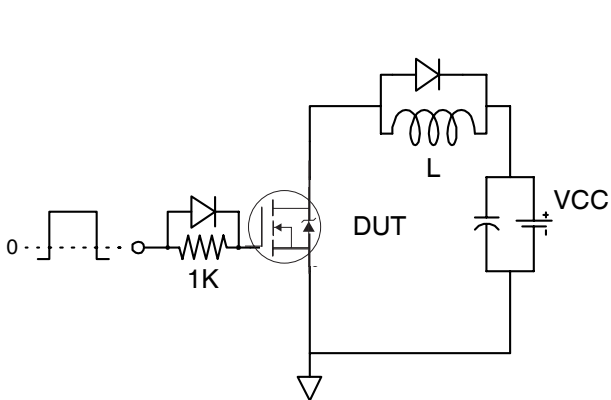
**Fig 15a.** Switching Time Test Circuit



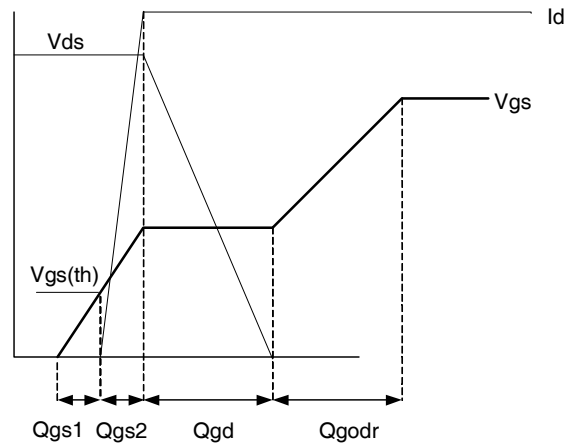
**Fig 15b.** Switching Time Waveforms



**Fig 16. Peak Diode Recovery  $dv/dt$  Test Circuit for N-Channel HEXFET<sup>®</sup> Power MOSFETs**

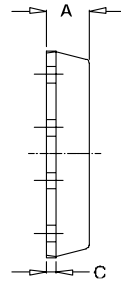


**Fig 17. Gate Charge Test Circuit**

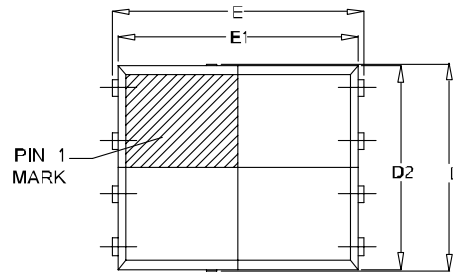


**Fig 18. Gate Charge Waveform**

# PQFN 5x6 Outline "E" Package Details

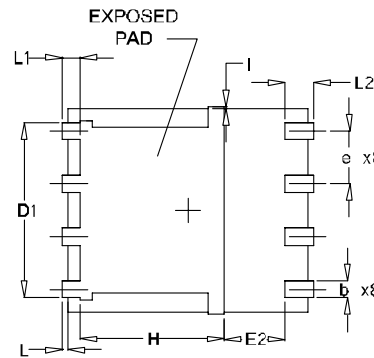


SIDEVIEW



TOP VIEW

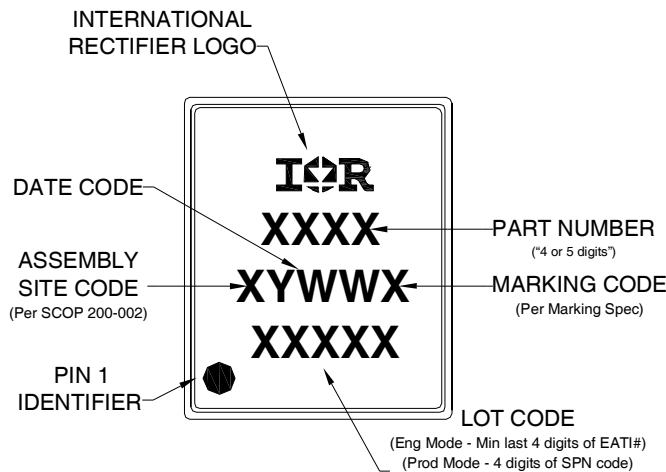
SYMBOL	OUTLINE PQFN 5X6E		
	MIN.	NOM	MAX.
A	0.90	1.03	1.17
b	0.33	0.41	0.48
C	0.20	0.25	0.35
D	4.80	4.98	5.15
D1	3.91	4.11	4.31
D2	4.80	4.90	5.00
E	5.90	6.02	6.15
E1	5.65	5.75	5.85
E2	1.10	—	—
e	1.27 BSC		
L	0.05	0.15	0.25
L1	0.38	0.44	0.50
L2	0.51	0.68	0.86
H	3.32	3.45	3.58
I	—	—	0.18



BOTTOM VIEW

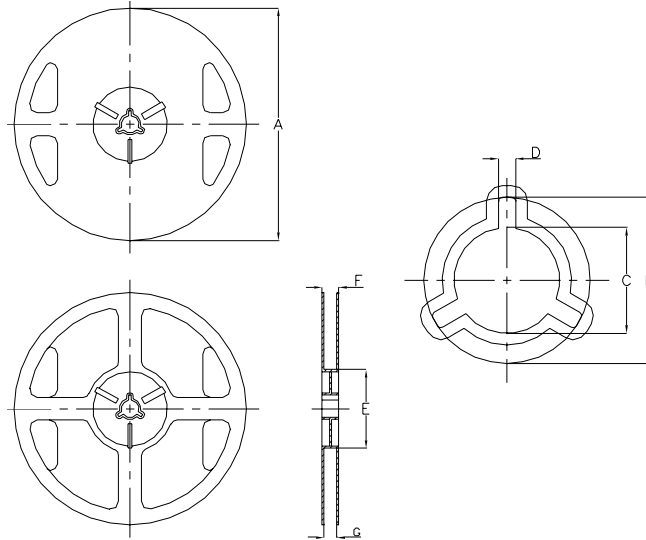
For more information on board mounting, including footprint and stencil recommendation, please refer to application note AN-1136: <http://www.irf.com/technical-info/appnotes/an-1136.pdf>  
 For more information on package inspection techniques, please refer to application note AN-1154: <http://www.irf.com/technical-info/appnotes/an-1154.pdf>

# PQFN 5x6 Outline "E" Part Marking



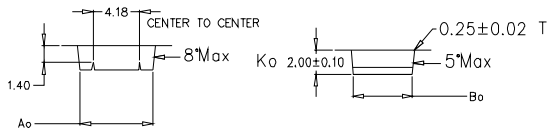
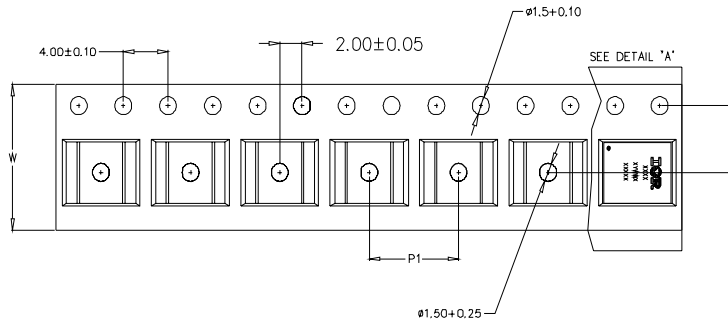
Note: For the most current drawing please refer to IR website at: <http://www.irf.com/package/>

# PQFN 5x6 Outline "E" Tape and Reel

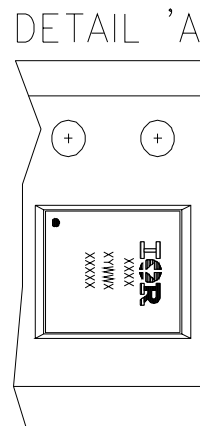


NOTE: Controlling dimensions in mm Std reel quantity is 4000 parts.

REEL DIMENSIONS								
CODE	STANDARD OPTION (QTY 4000)				TR2 OPTION (QTY 400)			
	METRIC		IMPERIAL		METRIC		IMPERIAL	
A	329.5	330.5	12.972	13.011	177.5	178.5	6.988	7.028
B	20.9	21.5	0.823	0.846	20.9	21.5	0.823	0.846
C	12.8	13.5	0.504	0.532	13.2	13.8	0.520	0.543
D	1.7	2.3	0.067	0.091	1.9	2.3	0.075	0.091
E	97	99	3.819	3.898	65	66	2.350	2.598
F	Ref	17.4			Ref	12		
G	13	14.5	0.512	0.571	13	14.5	0.512	0.571



Ao	6.50 ±0.10
Bo	5.28 ±0.10
F	5.50 ±0.05
P1	8.00 ±0.10
W	12.00 ±0.10





**Qualification information<sup>†</sup>**

Qualification level	Consumer <sup>††</sup> (per JEDEC JE S D47F <sup>†††</sup> guidelines )	
Moisture Sensitivity Level	PQFN 5mm x 6mm	MSL1 (per JEDEC J-S TD-020D <sup>†††</sup> )
RoHS compliant	Yes	

† Qualification standards can be found at International Rectifier’s web site  
<http://www.irf.com/product-info/reliability>

†† Higher qualification ratings may be available should the user have such requirements.  
 Please contact your International Rectifier sales representative for further information:  
<http://www.irf.com/whoto-call/salesrep/>

††† Applicable version of JEDEC standard at the time of product release.

**Notes:**

- ① Repetitive rating; pulse width limited by max. junction temperature.
- ② Starting  $T_J = 25^\circ\text{C}$ ,  $L = 0.22\text{mH}$ ,  $R_G = 50\Omega$ ,  $I_{AS} = 16.2\text{A}$ .
- ③ Pulse width  $\leq 400\mu\text{s}$ ; duty cycle  $\leq 2\%$ .
- ④  $R_\theta$  is measured at  $T_J$  of approximately  $90^\circ\text{C}$ .
- ⑤ When mounted on 1 inch square 2 oz copper pad on 1.5x1.5 in. board of FR-4 material.
- ⑥ Calculated continuous current based on maximum allowable junction temperature.
- ⑦ Current is limited to 16.2A by source bonding technology.

Date	Comment
1/17/2014	<ul style="list-style-type: none"> <li>• Updated ordering information to reflect the End-Of-Life (EOL) of the mini-reel option (EOL notice #259).</li> <li>• Updated data sheet with the new IR corporate template.</li> </ul>

## **IMPORTANT NOTICE**

The information given in this document shall in no event be regarded as a guarantee of conditions or characteristics ("Beschaffheitsgarantie").

With respect to any examples, hints or any typical values stated herein and/or any information regarding the application of the product, Infineon Technologies hereby disclaims any and all warranties and liabilities of any kind, including without limitation warranties of non-infringement of intellectual property rights of any third party.

In addition, any information given in this document is subject to customer's compliance with its obligations stated in this document and any applicable legal requirements, norms and standards concerning customer's products and any use of the product of Infineon Technologies in customer's applications.

The data contained in this document is exclusively intended for technically trained staff. It is the responsibility of customer's technical departments to evaluate the suitability of the product for the intended application and the completeness of the product information given in this document with respect to such application.

For further information on the product, technology, delivery terms and conditions and prices please contact your nearest Infineon Technologies office ([www.infineon.com](http://www.infineon.com)).

## **WARNINGS**

Due to technical requirements products may contain dangerous substances. For information on the types in question please contact your nearest Infineon Technologies office.

Except as otherwise explicitly approved by Infineon Technologies in a written document signed by authorized representatives of Infineon Technologies, Infineon Technologies' products may not be used in any applications where a failure of the product or any consequences of the use thereof can reasonably be expected to result in personal injury.