

Applications

- Brushed Motor drive applications
- BLDC Motor drive applications
- Battery powered circuits
- Half-bridge and full-bridge topologies
- Synchronous rectifier applications
- Resonant mode power supplies
- OR-ing and redundant power switches
- DC/DC and AC/DC converters
- DC/AC Inverters

Benefits

- Improved Gate, Avalanche and Dynamic dV/dt Ruggedness
- Fully Characterized Capacitance and Avalanche SOA
- Enhanced body diode dV/dt and dI/dt Capability
- RoHS Compliant containing no Lead, no Bromide, and no Halogen

HEXFET® Power MOSFET

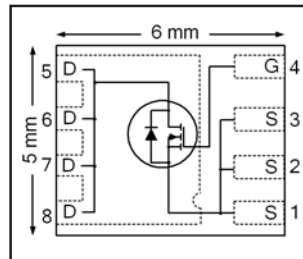

V_{DSS}	40V
R_{DS(on)} typ. max.	1.1mΩ
	1.4mΩ
I_D (Silicon Limited)	259A①
I_D (Package Limited)	100A

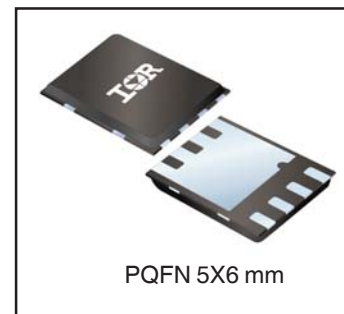

Base Part Number	Package Type	Standard Pack		Orderable Part Number
		Form	Quantity	
IRFH7004PBF	PQFN 5mm x 6mm	Tape and Reel	4000	IRFH7004TRPBF

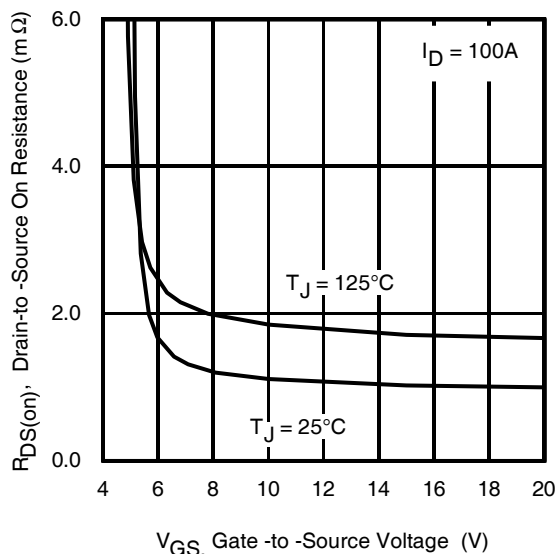

Fig 1. Typical On-Resistance vs. Gate Voltage

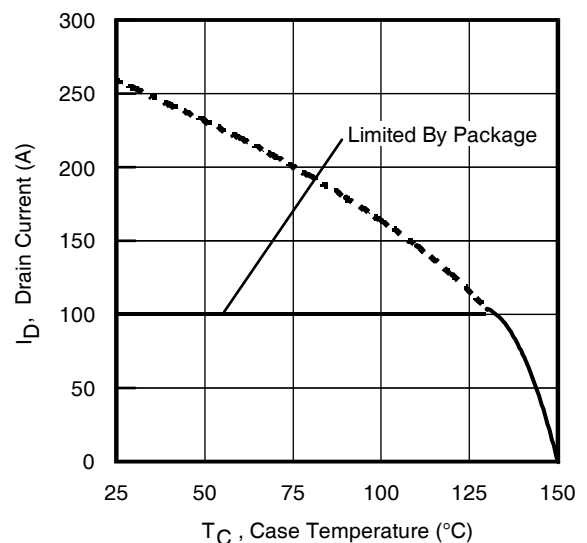

Fig 2. Maximum Drain Current vs. Case Temperature

Absolute Maximum Ratings

Symbol	Parameter	Max.	Units
$I_D @ T_C = 25^\circ\text{C}$	Continuous Drain Current, $V_{GS} @ 10\text{V}$ (Silicon Limited)	259 ^①	A
$I_D @ T_C = 100^\circ\text{C}$	Continuous Drain Current, $V_{GS} @ 10\text{V}$ (Silicon Limited)	164 ^①	
$I_D @ T_C = 25^\circ\text{C}$	Continuous Drain Current, $V_{GS} @ 10\text{V}$ (Wire Bond Limited)	100	
I_{DM}	Pulsed Drain Current ^②	1247	
$P_D @ T_C = 25^\circ\text{C}$	Maximum Power Dissipation	156	W
	Linear Derating Factor	1.3	W/°C
V_{GS}	Gate-to-Source Voltage	± 20	V
T_J	Operating Junction and	-55 to + 150	°C
T_{STG}	Storage Temperature Range		

Avalanche Characteristics

E_{AS} (Thermally limited)	Single Pulse Avalanche Energy ^③	191	mJ
E_{AS} (Thermally limited)	Single Pulse Avalanche Energy ^④	479	
I_{AR}	Avalanche Current ^②	See Fig. 14, 15, 22a, 22b	A
E_{AR}	Repetitive Avalanche Energy ^②		mJ

Thermal Resistance

Symbol	Parameter	Typ.	Max.	Units
$R_{\theta JC}$ (Bottom)	Junction-to-Case ^③	0.5	0.8	°C/W
$R_{\theta JC}$ (Top)	Junction-to-Case ^③	—	15	
$R_{\theta JA}$	Junction-to-Ambient ^③	—	34	
$R_{\theta JA} (<10\text{s})$	Junction-to-Ambient ^③	—	21	

Static @ $T_J = 25^\circ\text{C}$ (unless otherwise specified)

Symbol	Parameter	Min.	Typ.	Max.	Units	Conditions
$V_{(BR)DSS}$	Drain-to-Source Breakdown Voltage	40	—	—	V	$V_{GS} = 0\text{V}$, $I_D = 250\mu\text{A}$
$\Delta V_{(BR)DSS}/\Delta T_J$	Breakdown Voltage Temp. Coefficient	—	0.033	—	V/°C	Reference to 25°C , $I_D = 1.0\text{mA}$ ^②
$R_{DS(on)}$	Static Drain-to-Source On-Resistance	—	1.1	1.4	m Ω	$V_{GS} = 10\text{V}$, $I_D = 100\text{A}$ ^⑤
		—	1.7	—	m Ω	$V_{GS} = 6.0\text{V}$, $I_D = 50\text{A}$ ^⑤
$V_{GS(th)}$	Gate Threshold Voltage	2.2	3.0	3.9	V	$V_{DS} = V_{GS}$, $I_D = 150\mu\text{A}$
I_{DSS}	Drain-to-Source Leakage Current	—	—	1.0	μA	$V_{DS} = 40\text{V}$, $V_{GS} = 0\text{V}$
		—	—	150		$V_{DS} = 40\text{V}$, $V_{GS} = 0\text{V}$, $T_J = 125^\circ\text{C}$
I_{GSS}	Gate-to-Source Forward Leakage	—	—	100	nA	$V_{GS} = 20\text{V}$
	Gate-to-Source Reverse Leakage	—	—	-100		$V_{GS} = -20\text{V}$
R_G	Internal Gate Resistance	—	2.4	—	Ω	

Notes:

- ① Calculated continuous current based on maximum allowable junction temperature. Package is limited to 100A by production test capability. Note that current limitations arising from heating of the device leads may occur with some lead mounting arrangements. (Refer to AN-1140)
- ② Repetitive rating; pulse width limited by max. junction temperature.
- ③ Limited by T_{Jmax} , starting $T_J = 25^\circ\text{C}$, $L = 0.038\text{mH}$
 $R_G = 50\Omega$, $I_{AS} = 100\text{A}$, $V_{GS} = 10\text{V}$.
- ④ $I_{SD} \leq 100\text{A}$, $di/dt \leq 1366\text{A}/\mu\text{s}$, $V_{DD} \leq V_{(BR)DSS}$, $T_J \leq 150^\circ\text{C}$.
- ⑤ Pulse width $\leq 400\mu\text{s}$; duty cycle $\leq 2\%$.
- ⑥ C_{oss} eff. (TR) is a fixed capacitance that gives the same charging time as C_{oss} while V_{DS} is rising from 0 to 80% V_{DSS} .
- ⑦ C_{oss} eff. (ER) is a fixed capacitance that gives the same energy as C_{oss} while V_{DS} is rising from 0 to 80% V_{DSS} .
- ⑧ When mounted on 1 inch square 2 oz copper pad on 1.5 x 1.5 in. board of FR-4 material.
- ⑨ R_θ is measured at T_J approximately 90°C .
- ⑩ Limited by T_{Jmax} , starting $T_J = 25^\circ\text{C}$, $L = 1\text{mH}$, $R_G = 50\Omega$, $I_{AS} = 31\text{A}$, $V_{GS} = 10\text{V}$.

Dynamic @ $T_J = 25^\circ\text{C}$ (unless otherwise specified)

Symbol	Parameter	Min.	Typ.	Max.	Units	Conditions
g_{fs}	Forward Transconductance	117	—	—	S	$V_{DS} = 10\text{V}$, $I_D = 100\text{A}$
Q_g	Total Gate Charge	—	129	194	nC	$I_D = 100\text{A}$ $V_{DS} = 20\text{V}$ $V_{GS} = 10\text{V}$ ⑤
Q_{gs}	Gate-to-Source Charge	—	34	—		
Q_{gd}	Gate-to-Drain ("Miller") Charge	—	40	—		
Q_{sync}	Total Gate Charge Sync. ($Q_g - Q_{gd}$)	—	169	—		
$t_{d(on)}$	Turn-On Delay Time	—	15	—	ns	$V_{DD} = 20\text{V}$ $I_D = 30\text{A}$ $R_G = 2.7\Omega$ $V_{GS} = 10\text{V}$ ⑤
t_r	Rise Time	—	51	—		
$t_{d(off)}$	Turn-Off Delay Time	—	73	—		
t_f	Fall Time	—	49	—		
C_{iss}	Input Capacitance	—	6419	—	pF	$V_{GS} = 0\text{V}$ $V_{DS} = 25\text{V}$ $f = 1.0\text{MHz}$ $V_{GS} = 0\text{V}$, $V_{DS} = 0\text{V}$ to 32V ⑦ $V_{GS} = 0\text{V}$, $V_{DS} = 0\text{V}$ to 32V ⑧
C_{oss}	Output Capacitance	—	952	—		
C_{rss}	Reverse Transfer Capacitance	—	656	—		
C_{oss} eff. (ER)	Effective Output Capacitance (Energy Related)	—	1161	—		
C_{oss} eff. (TR)	Effective Output Capacitance (Time Related)	—	1305	—		

Diode Characteristics

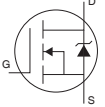
Symbol	Parameter	Min.	Typ.	Max.	Units	Conditions
I_S	Continuous Source Current (Body Diode)	—	—	100①	A	MOSFET symbol showing the integral reverse p-n junction diode. 
I_{SM}	Pulsed Source Current (Body Diode) ②	—	—	1247	A	
V_{SD}	Diode Forward Voltage	—	0.95	1.3	V	$T_J = 25^\circ\text{C}$, $I_S = 100\text{A}$, $V_{GS} = 0\text{V}$ ③
dv/dt	Peak Diode Recovery ④	—	2.5	—	V/ns	$T_J = 175^\circ\text{C}$, $I_S = 100\text{A}$, $V_{DS} = 40\text{V}$
t_{rr}	Reverse Recovery Time	—	35	—	ns	$T_J = 25^\circ\text{C}$ $V_R = 34\text{V}$, $T_J = 125^\circ\text{C}$ $I_F = 100\text{A}$
Q_{rr}	Reverse Recovery Charge	—	26	—		
		—	27	—		$T_J = 25^\circ\text{C}$ $T_J = 125^\circ\text{C}$ $di/dt = 100\text{A}/\mu\text{s}$ ⑤
I_{RRM}	Reverse Recovery Current	—	1.5	—	A	$T_J = 25^\circ\text{C}$

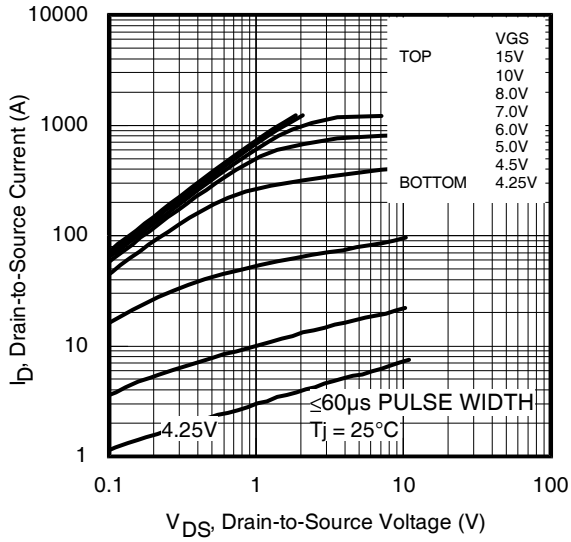
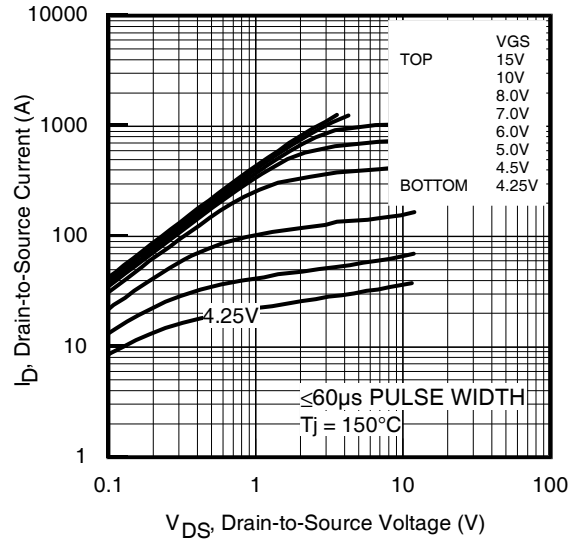
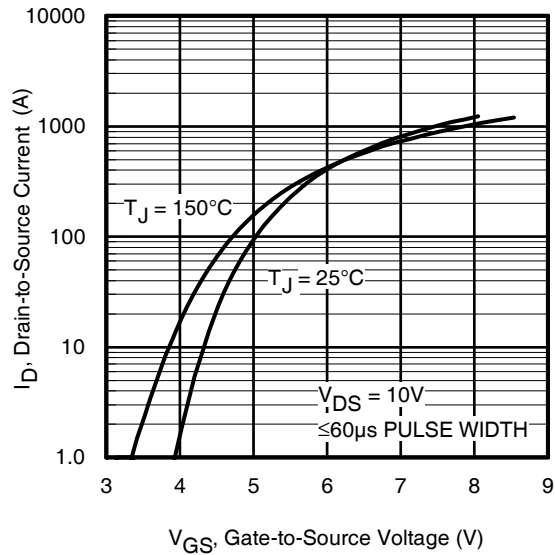
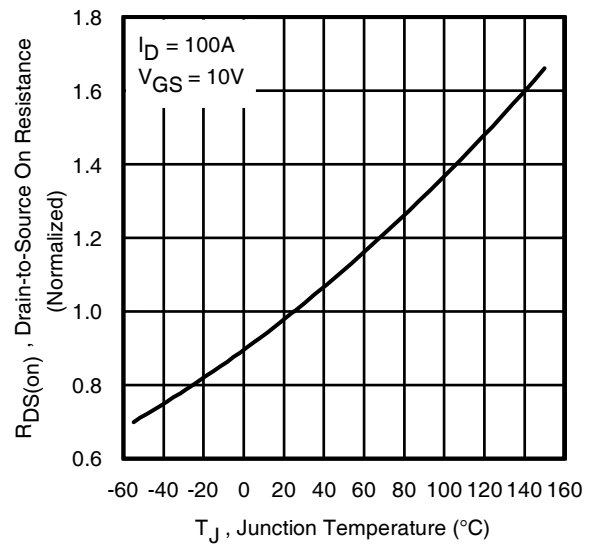
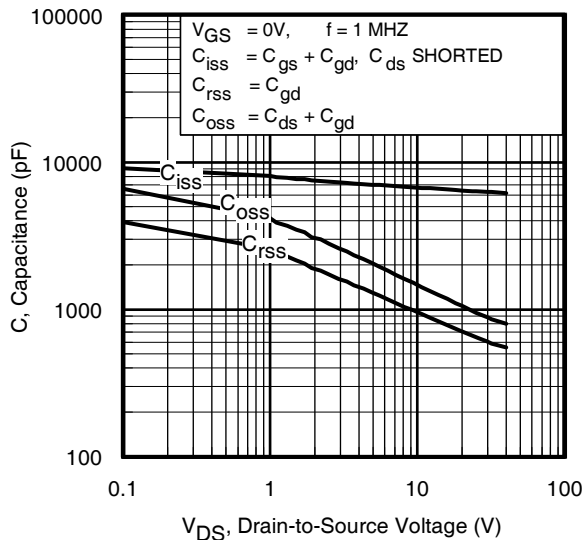
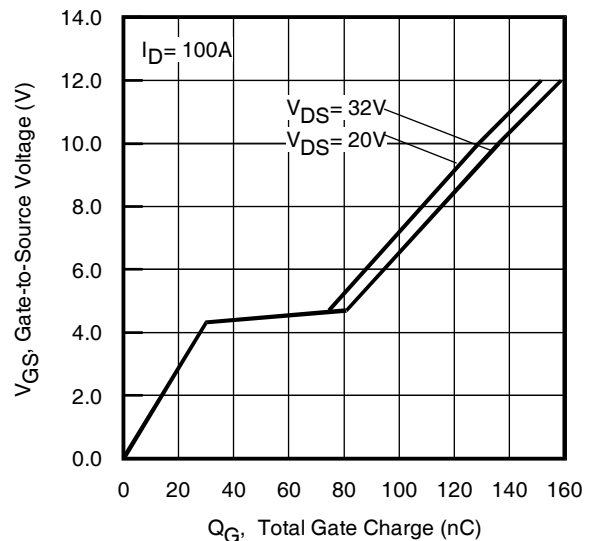
Fig 3. Typical Output Characteristics

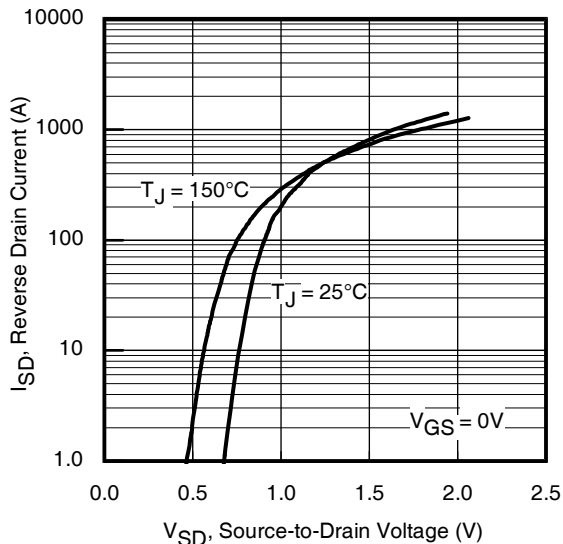
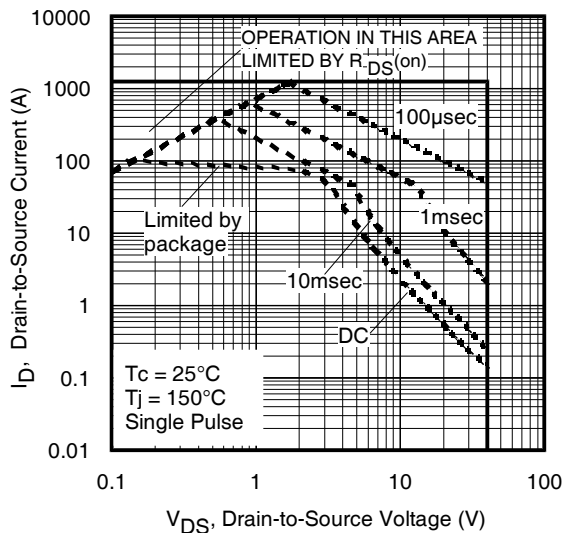
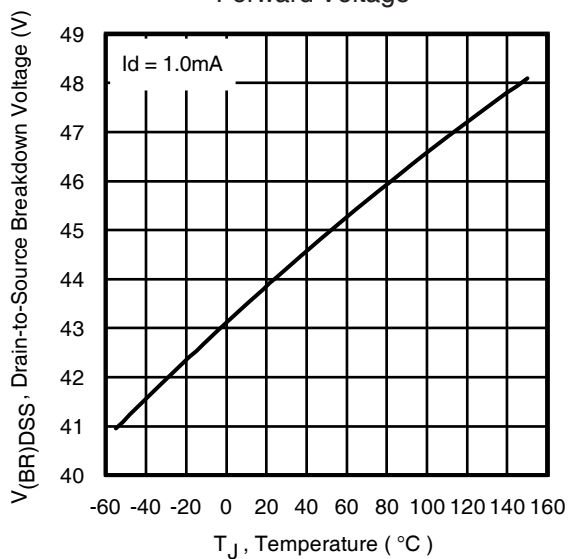
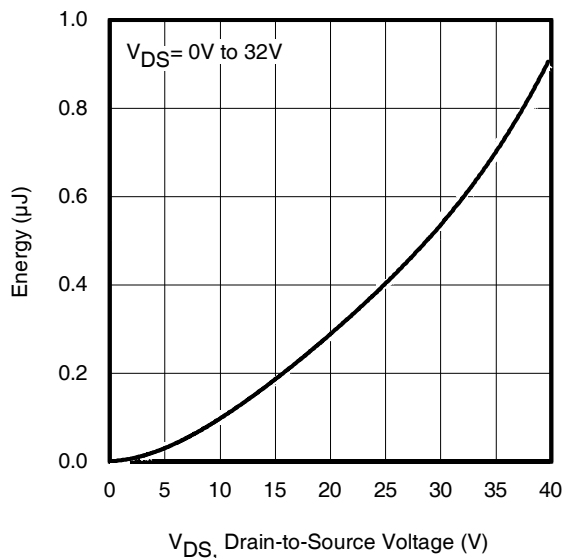
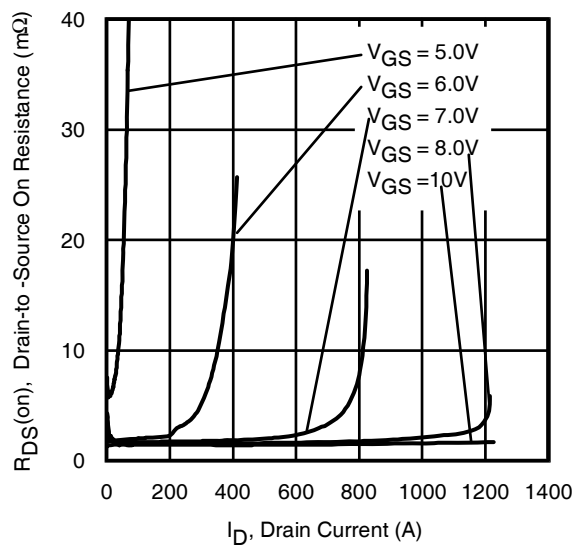
Fig 4. Typical Output Characteristics

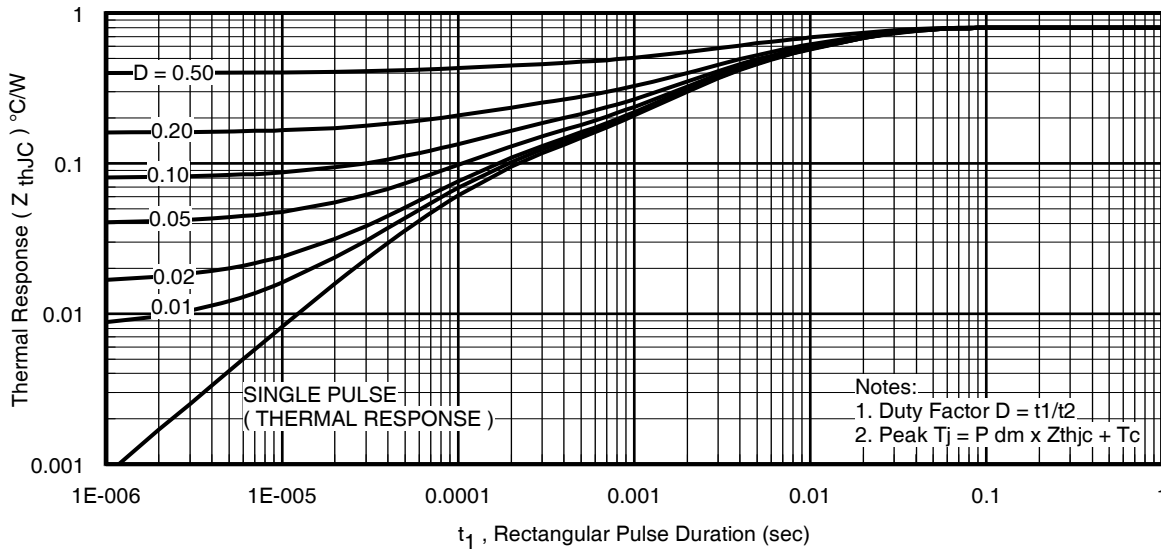
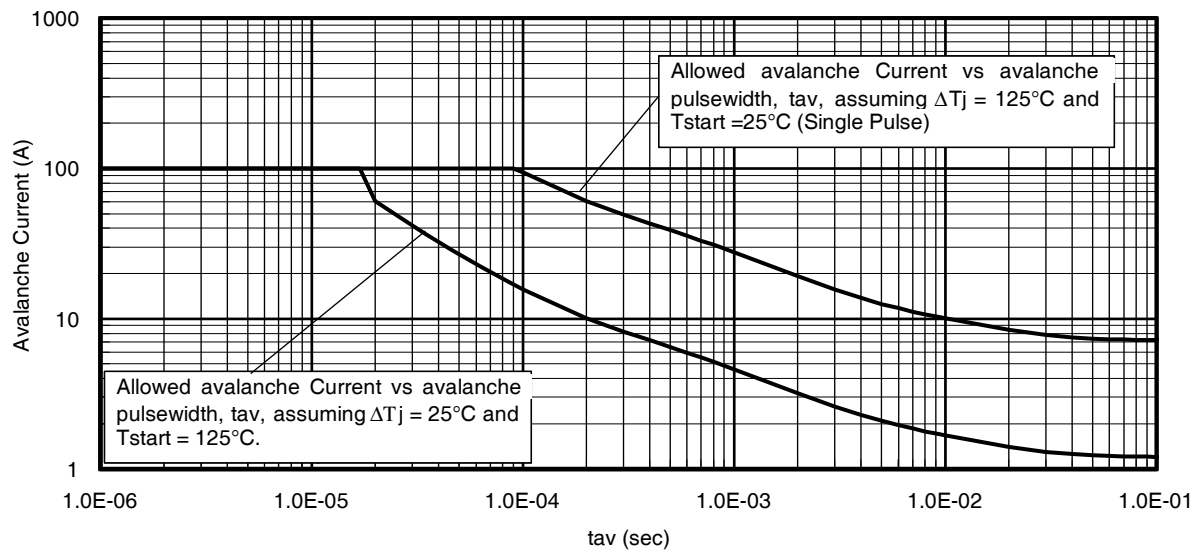
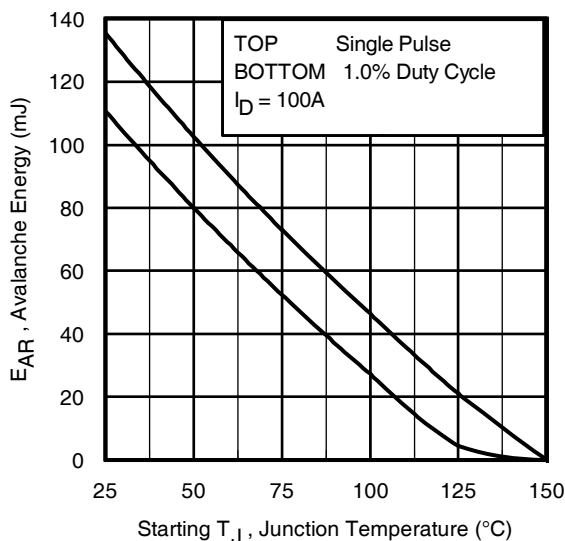
Fig 5. Typical Transfer Characteristics

Fig 6. Normalized On-Resistance vs. Temperature

Fig 7. Typical Capacitance vs. Drain-to-Source Voltage

Fig 8. Typical Gate Charge vs. Gate-to-Source Voltage

Fig 9. Typical Source-Drain Diode Forward Voltage

Fig 10. Maximum Safe Operating Area

Fig 11. Drain-to-Source Breakdown Voltage

Fig 12. Typical C_{OSS} Stored Energy

Fig 13. Typical On-Resistance vs. Drain Current

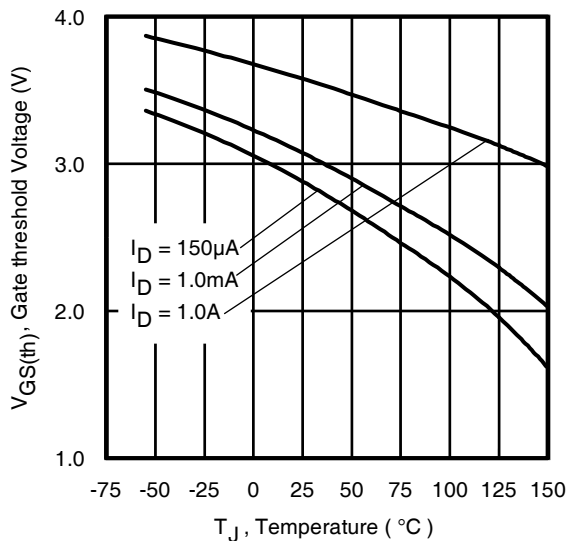
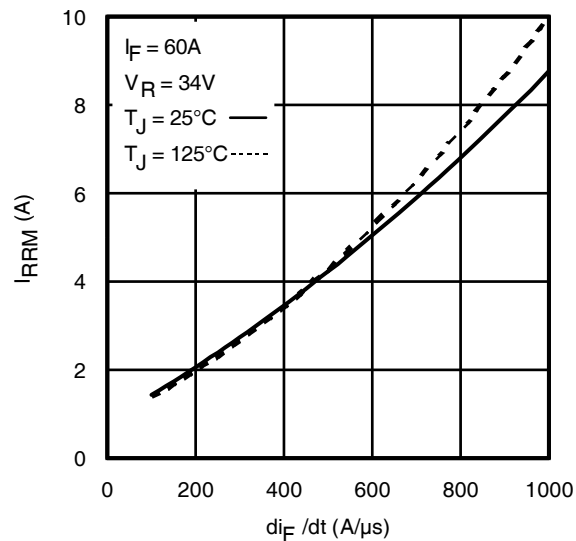
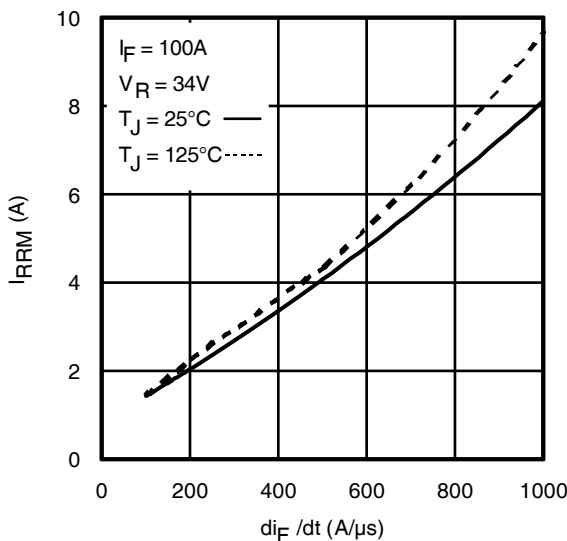
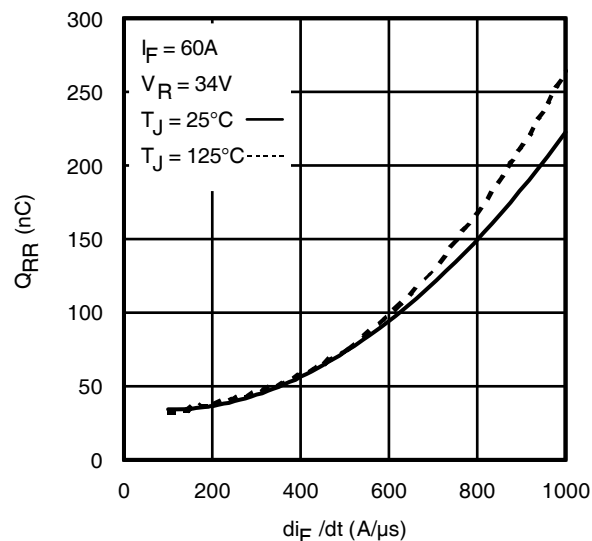
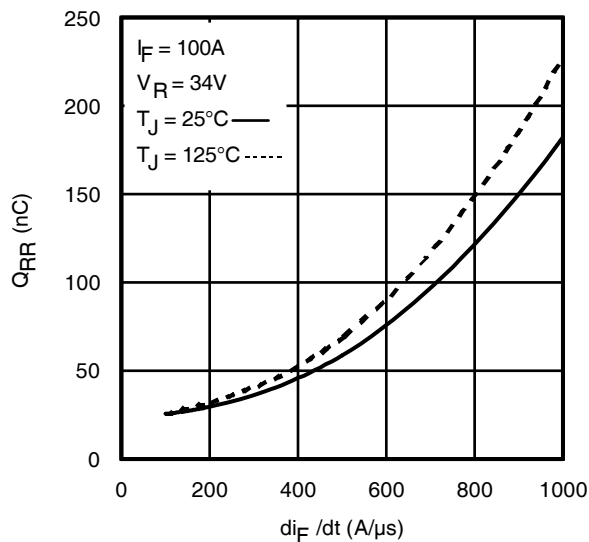

Fig 14. Maximum Effective Transient Thermal Impedance, Junction-to-Case

Fig 15. Typical Avalanche Current vs. Pulsewidth

Fig 16. Maximum Avalanche Energy vs. Temperature
**Notes on Repetitive Avalanche Curves , Figures 14, 15:
(For further info, see AN-1005 at www.irf.com)**

1. Avalanche failures assumption:
Purely a thermal phenomenon and failure occurs at a temperature far in excess of T_{jmax} . This is validated for every part type.
2. Safe operation in Avalanche is allowed as long as T_{jmax} is not exceeded.
3. Equation below based on circuit and waveforms shown in Figures 16a, 16b.
4. $P_{D(ave)}$ = Average power dissipation per single avalanche pulse.
5. BV = Rated breakdown voltage (1.3 factor accounts for voltage increase during avalanche).
6. I_{av} = Allowable avalanche current.
7. ΔT = Allowable rise in junction temperature, not to exceed T_{jmax} (assumed as 25°C in Figure 14, 15).
 t_{av} = Average time in avalanche.
 D = Duty cycle in avalanche = $t_{av} \cdot f$
 $Z_{thJC}(D, t_{av})$ = Transient thermal resistance, see Figures 13)

$$P_{D(ave)} = 1/2 (1.3 \cdot BV \cdot I_{av}) = \Delta T / Z_{thJC}$$

$$I_{av} = 2\Delta T / [1.3 \cdot BV \cdot Z_{th}]$$

$$E_{AS(AR)} = P_{D(ave)} \cdot t_{av}$$

Fig 17. Threshold Voltage vs. Temperature

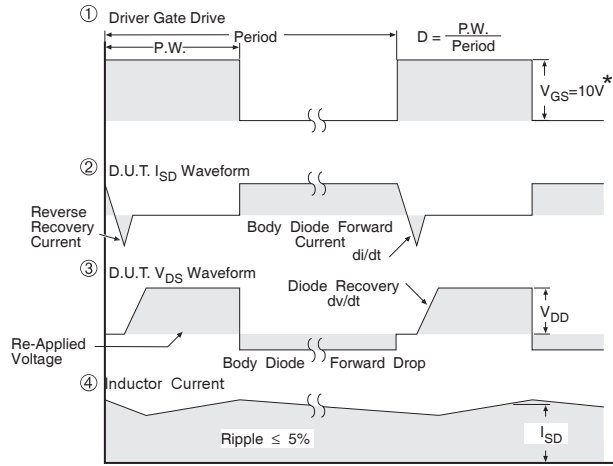
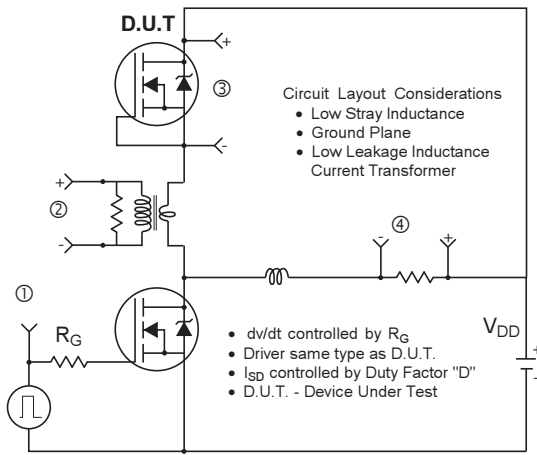
Fig. 18 - Typical Recovery Current vs. di_f/dt

Fig. 19 - Typical Recovery Current vs. di_f/dt

Fig. 20 - Typical Stored Charge vs. di_f/dt

Fig. 21 - Typical Stored Charge vs. di_f/dt



* $V_{GS} = 5V$ for Logic Level Devices

Fig 22. Peak Diode Recovery dv/dt Test Circuit for N-Channel HEXFET® Power MOSFETs

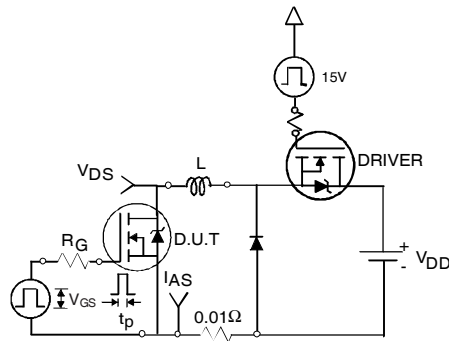

Fig 22a. Unclamped Inductive Test Circuit



Fig 22b. Unclamped Inductive Waveforms

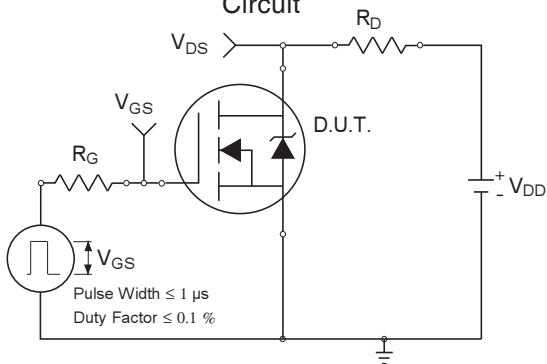

Fig 23a. Switching Time Test Circuit

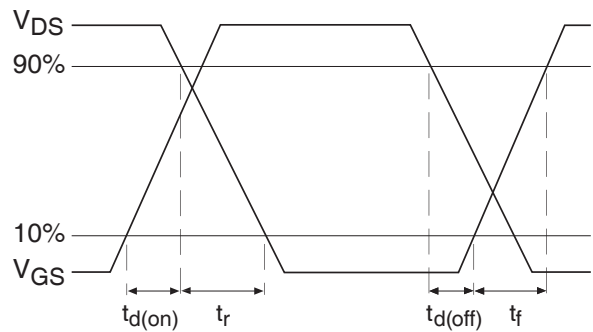

Fig 23b. Switching Time Waveforms

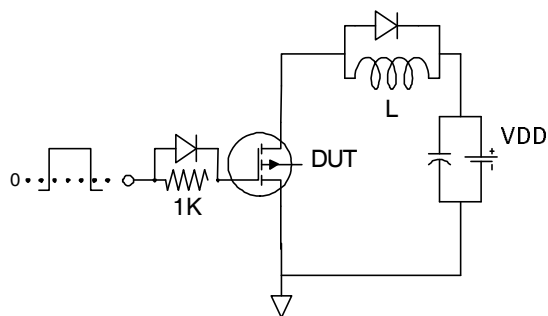
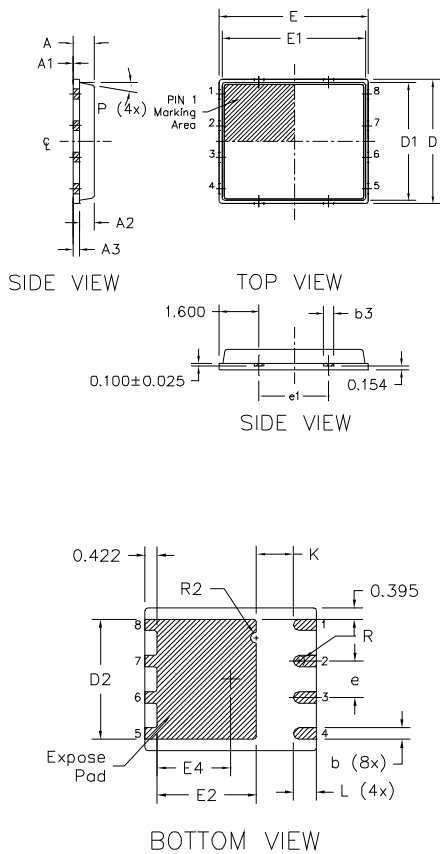

Fig 24a. Gate Charge Test Circuit



Fig 24b. Gate Charge Waveform

PQFN 5x6 Outline "B" Package Details



DIM SYMBOL	MILLIMETERS		INCH	
	MIN	MAX	MIN	MAX
A	0.800	0.900	0.0315	0.0543
A1	0.000	0.050	0.0000	0.0020
A3	0.200 REF		0.0079 REF	
b	0.350	0.470	0.0138	0.0185
b1	0.025	0.125	0.0010	0.0049
b2	0.210	0.410	0.0083	0.0161
b3	0.150	0.450	0.0059	0.0177
D	5.000 BSC		0.1969 BSC	
D1	4.750 BSC		0.1870 BSC	
D2	4.100	4.300	0.1614	0.1693
E	6.000 BSC		0.2362 BSC	
E1	5.750 BSC		0.2264 BSC	
E2	3.380	3.780	0.1331	0.1488
e	1.270 REF		0.0500 REF	
e1	2.800 REF		0.1102 REF	
K	1.200	1.420	0.0472	0.0559
L	0.710	0.900	0.0280	0.0354
P	0°	12°	0°	12°
R	0.200 REF		0.0079 REF	
R2	0.150	0.200	0.0059	0.0079

- Note:**
1. Dimensions and tolerancing confirm to ASME Y14.5M-1994
 2. Dimension L represents terminal full back from package edge up to 0.1mm is acceptable
 3. Coplanarity applies to the expose Heat Slug as well as the terminal
 4. Radius on terminal is Optional

For more information on board mounting, including footprint and stencil recommendation, please refer to application note AN-1136:

<http://www.irf.com/technical-info/appnotes/an-1136.pdf>

For more information on package inspection techniques, please refer to application note AN-1154:

<http://www.irf.com/technical-info/appnotes/an-1154.pdf>

PQFN 5x6 Part Marking

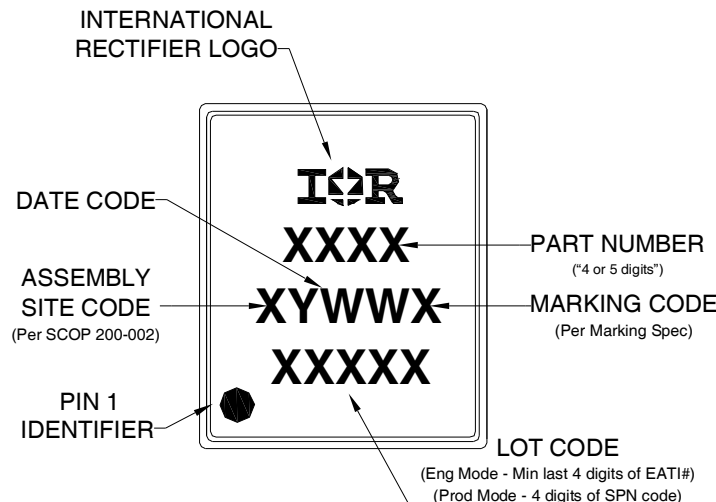

Note: For the most current drawing please refer to IR website at: <http://www.irf.com/package/>

PQFN 5x6 Tape and Reel

REEL DIMENSIONS

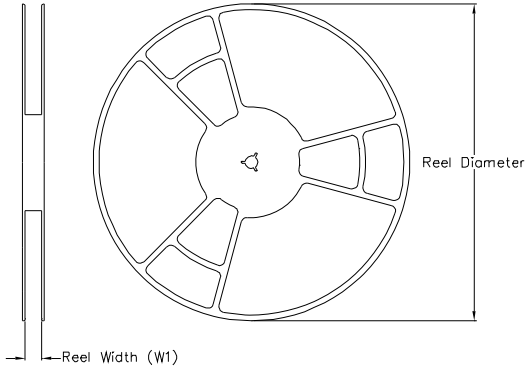

TAPE DIMENSIONS

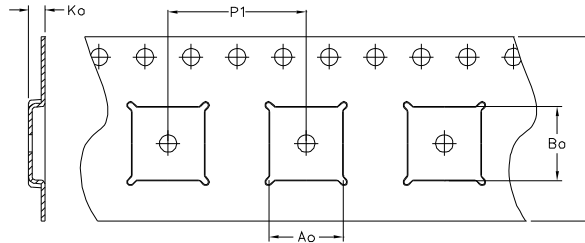

CODE	DESCRIPTION
Ao	Dimension design to accommodate the component width
Bo	Dimension design to accommodate the component length
Ko	Dimension design to accommodate the component thickness
W	Overall width of the carrier tape
P1	Pitch between successive cavity centers

QUADRANT ASSIGNMENTS FOR PIN 1 ORIENTATION IN TAPE

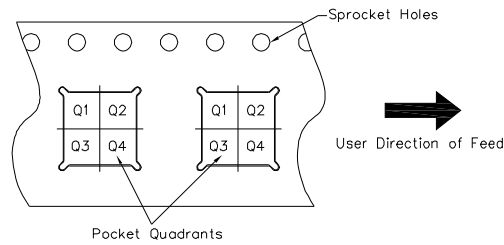

Note: All dimension are nominal

Package Type	Reel Diameter (Inch)	QTY	Reel Width W1 (mm)	Ao (mm)	Bo (mm)	Ko (mm)	P1 (mm)	W (mm)	Pin 1 Quadrant
5 X 6 PQFN	13	4000	12.4	6.300	5.300	1.20	8.00	12	Q1

Note: For the most current drawing please refer to IR website at: <http://www.irf.com/package/>

Qualification information[†]

Qualification level	Industrial (per JEDEC JESD47F ^{††} guidelines)	
Moisture Sensitivity Level	PQFN 5mm x 6mm	MSL1 (per JEDEC J-STD-020D ^{††})
RoHS compliant	Yes	

† Qualification standards can be found at International Rectifier's web site: <http://www.irf.com/product-info/reliability/>

†† Applicable version of JEDEC standard at the time of product release.

Revision History

Date	Comment
2/19/2015	<ul style="list-style-type: none"> • Updated $E_{AS(L=1mH)} = 479mJ$ on page 2 • Updated note 10 "Limited by T_{Jmax}, starting $T_J = 25^{\circ}C$, $L = 1mH$, $R_G = 50\Omega$, $I_{AS} = 31A$, $V_{GS} = 10V$". on page 2
3/17/2015	<ul style="list-style-type: none"> • Updated package outline and tape and reel on pages 9 and 10.

IMPORTANT NOTICE

The information given in this document shall in no event be regarded as a guarantee of conditions or characteristics ("Beschaffheitsgarantie").

With respect to any examples, hints or any typical values stated herein and/or any information regarding the application of the product, Infineon Technologies hereby disclaims any and all warranties and liabilities of any kind, including without limitation warranties of non-infringement of intellectual property rights of any third party.

In addition, any information given in this document is subject to customer's compliance with its obligations stated in this document and any applicable legal requirements, norms and standards concerning customer's products and any use of the product of Infineon Technologies in customer's applications.

The data contained in this document is exclusively intended for technically trained staff. It is the responsibility of customer's technical departments to evaluate the suitability of the product for the intended application and the completeness of the product information given in this document with respect to such application.

For further information on the product, technology, delivery terms and conditions and prices please contact your nearest Infineon Technologies office (www.infineon.com).

WARNINGS

Due to technical requirements products may contain dangerous substances. For information on the types in question please contact your nearest Infineon Technologies office.

Except as otherwise explicitly approved by Infineon Technologies in a written document signed by authorized representatives of Infineon Technologies, Infineon Technologies' products may not be used in any applications where a failure of the product or any consequences of the use thereof can reasonably be expected to result in personal injury.