

IRFB812PbF

HEXFET® Power MOSFET

Applications

- Zero Voltage Switching SMPS
- Uninterruptible Power Supplies
- Motor Control applications

V_{DSS}	$R_{DS(on)}$ typ.	T_{rr} typ.	I_D
500V	1.75Ω	75ns	3.6A

Features and Benefits

- Fast body diode eliminates the need for external diodes in ZVS applications.
- Lower Gate charge results in simpler drive requirements.
- Higher Gate voltage threshold offers improved noise immunity.

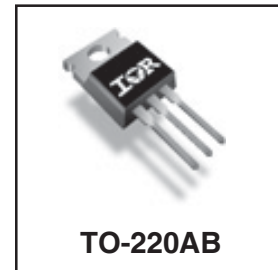

Absolute Maximum Ratings

	Parameter	Max.	Units
I_D @ $T_C = 25^\circ\text{C}$	Continuous Drain Current, V_{GS} @ 10V	3.6	A
I_D @ $T_C = 100^\circ\text{C}$	Continuous Drain Current, V_{GS} @ 10V	2.3	
I_{DM}	Pulsed Drain Current ①	14.4	
P_D @ $T_C = 25^\circ\text{C}$	Power Dissipation	78	W
	Linear Derating Factor	0.63	W/°C
V_{GS}	Gate-to-Source Voltage	± 20	V
dv/dt	Peak Diode Recovery dv/dt ③	32	V/ns
T_J T_{STG}	Operating Junction and Storage Temperature Range	-55 to + 150	°C
	Soldering Temperature, for 10 seconds	300 (1.6mm from case)	
	Mounting torque, 6-32 or M3 screw	10lb·in (1.1N·m)	

Diode Characteristics

Symbol	Parameter	Min.	Typ.	Max.	Units	Conditions
I_S	Continuous Source Current (Body Diode)	—	—	3.6	A	MOSFET symbol showing the integral reverse p-n junction diode.
I_{SM}	Pulsed Source Current (Body Diode) ①	—	—	14.4		
V_{SD}	Diode Forward Voltage	—	—	1.2	V	$T_J = 25^\circ\text{C}$, $I_S = 3.6\text{A}$, $V_{GS} = 0\text{V}$ ④
t_{rr}	Reverse Recovery Time	—	75	110	ns	$T_J = 25^\circ\text{C}$, $I_F = 3.6\text{A}$
		—	94	140		$T_J = 125^\circ\text{C}$, $di/dt = 100\text{A}/\mu\text{s}$ ④
Q_{rr}	Reverse Recovery Charge	—	135	200	nC	$T_J = 25^\circ\text{C}$, $I_S = 3.6\text{A}$, $V_{GS} = 0\text{V}$ ④
		—	220	330		$T_J = 125^\circ\text{C}$, $di/dt = 100\text{A}/\mu\text{s}$ ④
I_{RRM}	Reverse Recovery Current	—	3.2	4.8	A	$T_J = 25^\circ\text{C}$
t_{on}	Forward Turn-On Time	Intrinsic turn-on time is negligible (turn-on is dominated by LS+LD)				

Notes ① through ⑥ are on page 2

www.irf.com

IRFB812PbF

International
IR Rectifier

Static @ $T_J = 25^\circ\text{C}$ (unless otherwise specified)

Symbol	Parameter	Min.	Typ.	Max.	Units	Conditions
$V_{(BR)DSS}$	Drain-to-Source Breakdown Voltage	500	—	—	V	$V_{GS} = 0V, I_D = 250\mu\text{A}$
$\Delta V_{(BR)DSS}/\Delta T_J$	Breakdown Voltage Temp. Coefficient	—	0.37	—	V/°C	Reference to $25^\circ\text{C}, I_D = 250\mu\text{A}$
$R_{DS(on)}$	Static Drain-to-Source On-Resistance	—	1.75	2.2	Ω	$V_{GS} = 10V, I_D = 2.2A$ ④
$V_{GS(th)}$	Gate Threshold Voltage	3.0	—	5.0	V	$V_{DS} = V_{GS}, I_D = 250\mu\text{A}$
I_{DSS}	Drain-to-Source Leakage Current	—	—	25	μA	$V_{DS} = 500V, V_{GS} = 0V$
		—	—	2.0	mA	$V_{DS} = 400V, V_{GS} = 0V, T_J = 125^\circ\text{C}$
I_{GSS}	Gate-to-Source Forward Leakage	—	—	100	nA	$V_{GS} = 20V$
	Gate-to-Source Reverse Leakage	—	—	-100	nA	$V_{GS} = -20V$

Dynamic @ $T_J = 25^\circ\text{C}$ (unless otherwise specified)

Symbol	Parameter	Min.	Typ.	Max.	Units	Conditions
g_{fs}	Forward Transconductance	7.6	—	—	S	$V_{DS} = 50V, I_D = 2.2A$
Q_g	Total Gate Charge	—	—	20	nC	$I_D = 3.6A$ $V_{DS} = 400V$ $V_{GS} = 10V$, See Fig.14a & 14b ④
Q_{gs}	Gate-to-Source Charge	—	—	7.3		
Q_{gd}	Gate-to-Drain ("Miller") Charge	—	—	7.1		
$t_{d(on)}$	Turn-On Delay Time	—	14	—	ns	$V_{DD} = 250V$ $I_D = 3.6A$ $R_G = 17\Omega$ $V_{GS} = 10V$, See Fig. 15a & 15b ④
t_r	Rise Time	—	22	—		
$t_{d(off)}$	Turn-Off Delay Time	—	24	—		
t_f	Fall Time	—	17	—		
C_{iss}	Input Capacitance	—	810	—	pF	$V_{GS} = 0V$ $V_{DS} = 25V$ $f = 1.0\text{MHz}$, See Fig. 5 $V_{GS} = 0V, V_{DS} = 1.0V, f = 1.0\text{MHz}$ $V_{GS} = 0V, V_{DS} = 400V, f = 1.0\text{MHz}$ $V_{GS} = 0V, V_{DS} = 0V$ to $400V$ ⑤
C_{oss}	Output Capacitance	—	47	—		
C_{riss}	Reverse Transfer Capacitance	—	7.3	—		
C_{oss}	Output Capacitance	—	610	—		
C_{oss}	Output Capacitance	—	16	—		
$C_{oss \text{ eff.}}$	Effective Output Capacitance	—	5.9	—		
$C_{oss \text{ eff. (ER)}}$	Effective Output Capacitance (Energy Related)	—	37	—		

Avalanche Characteristics

Symbol	Parameter	Typ.	Max.	Units
E_{AS}	Single Pulse Avalanche Energy ②	—	150	mJ
I_{AR}	Avalanche Current ①	—	1.8	A
E_{AR}	Repetitive Avalanche Energy ①	—	7.8	mJ

Thermal Resistance

Symbol	Parameter	Typ.	Max.	Units
$R_{\theta JC}$	Junction-to-Case ⑥	—	1.6	°C/W
$R_{\theta CS}$	Case-to-Sink, Flat, Greased Surface	0.5	—	
$R_{\theta JA}$	Junction-to-Ambient ⑥	—	62	

Notes:

- ① Repetitive rating; pulse width limited by max. junction temperature. (See Fig. 11)
- ② Starting $T_J = 25^\circ\text{C}$, $L = 93\text{mH}$, $R_G = 25\Omega$, $I_{AS} = 1.8A$. (See Figure 13).
- ③ $I_{SD} = 3.6A$, $di/dt \leq 520A/\mu\text{s}$, $V_{DD}V_{(BR)DSS}$, $T_J \leq 150^\circ\text{C}$.

④ Pulse width $\leq 300\mu\text{s}$; duty cycle $\leq 2\%$.

⑤ $C_{oss \text{ eff.}}$ is a fixed capacitance that gives the same charging time as C_{oss} while V_{DS} is rising from 0 to 80% V_{DSS} .

$C_{oss \text{ eff. (ER)}}$ is a fixed capacitance that stores the same energy as C_{oss} while V_{DS} is rising from 0 to 80% V_{DSS} .

⑥ R_{θ} is measured at T_J approximately 90°C

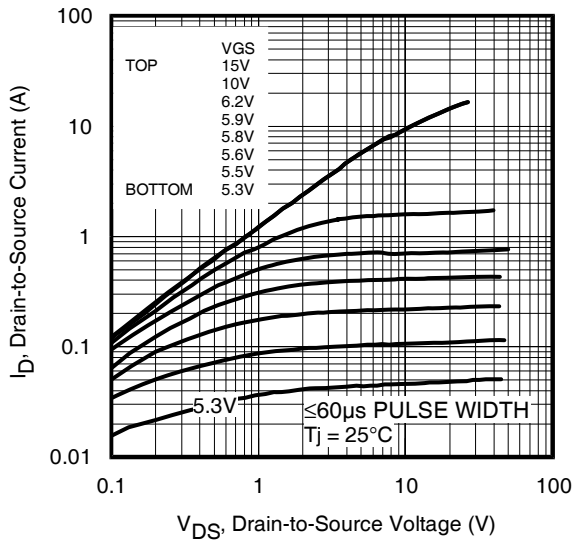

Fig 1. Typical Output Characteristics

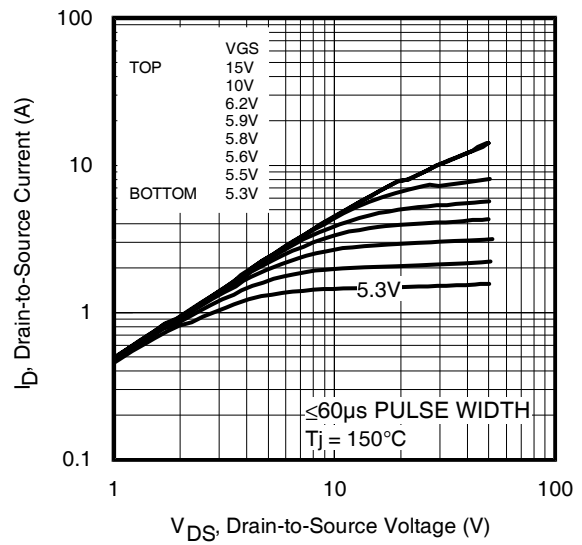

Fig 2. Typical Output Characteristics

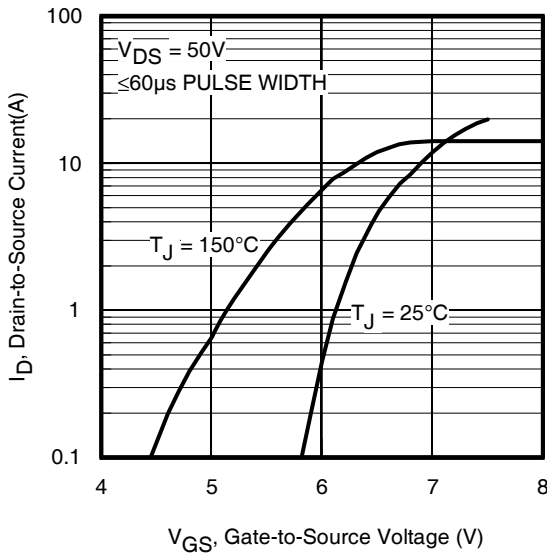

Fig 3. Typical Transfer Characteristics

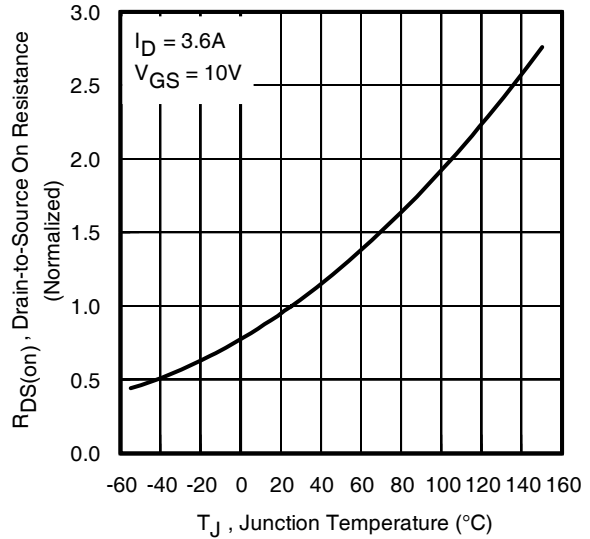

Fig 4. Normalized On-Resistance Vs. Temperature

IRFB812PbF

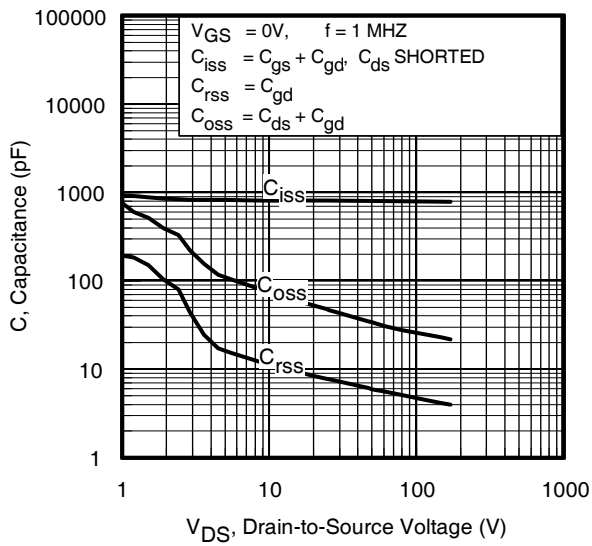

Fig 5. Typical Capacitance Vs. Drain-to-Source Voltage

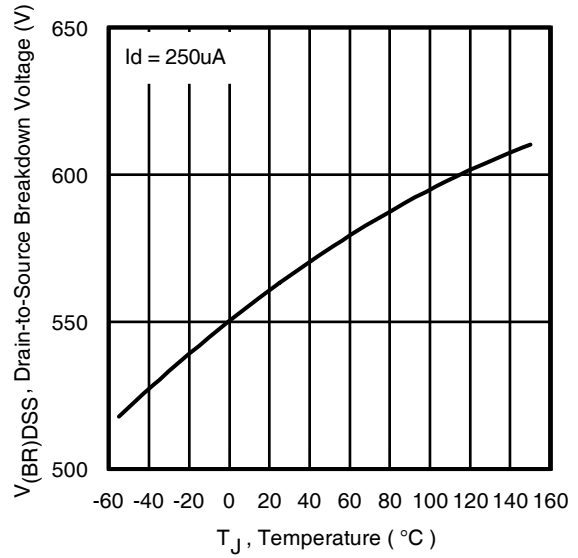
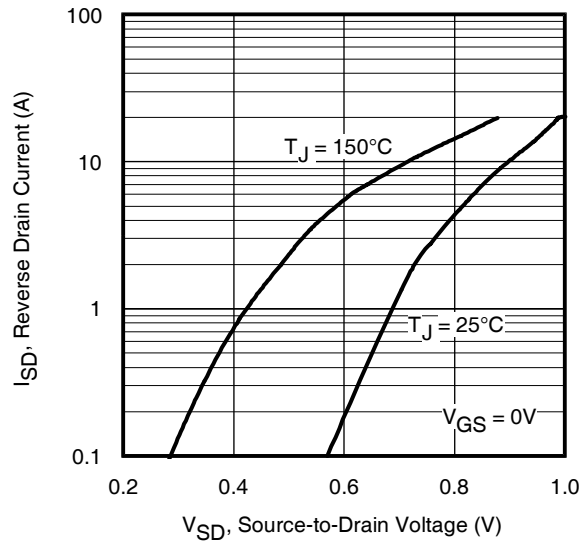
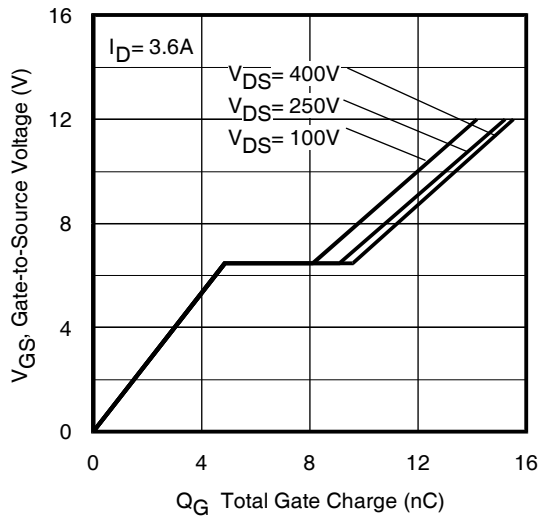

Fig 6. Typ. Breakdown Voltage vs. Temperature



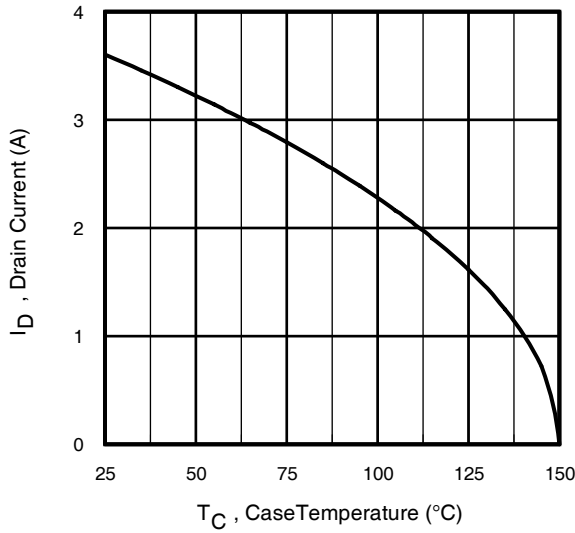

Fig 9. Maximum Drain Current Vs. Case Temperature

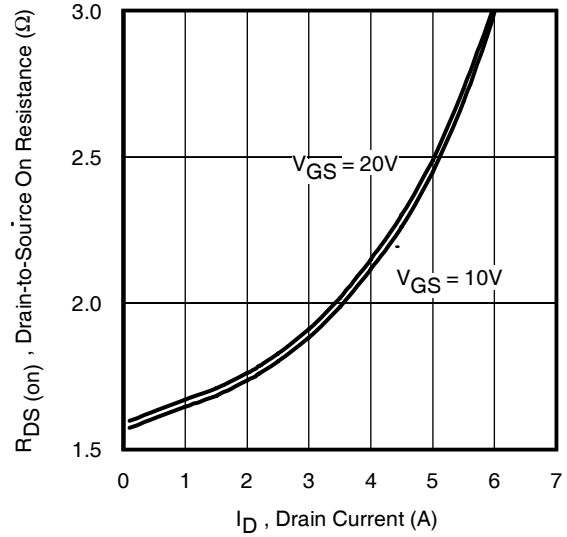

Fig 9. Typical $R_{DS(on)}$ Vs. Drain Current

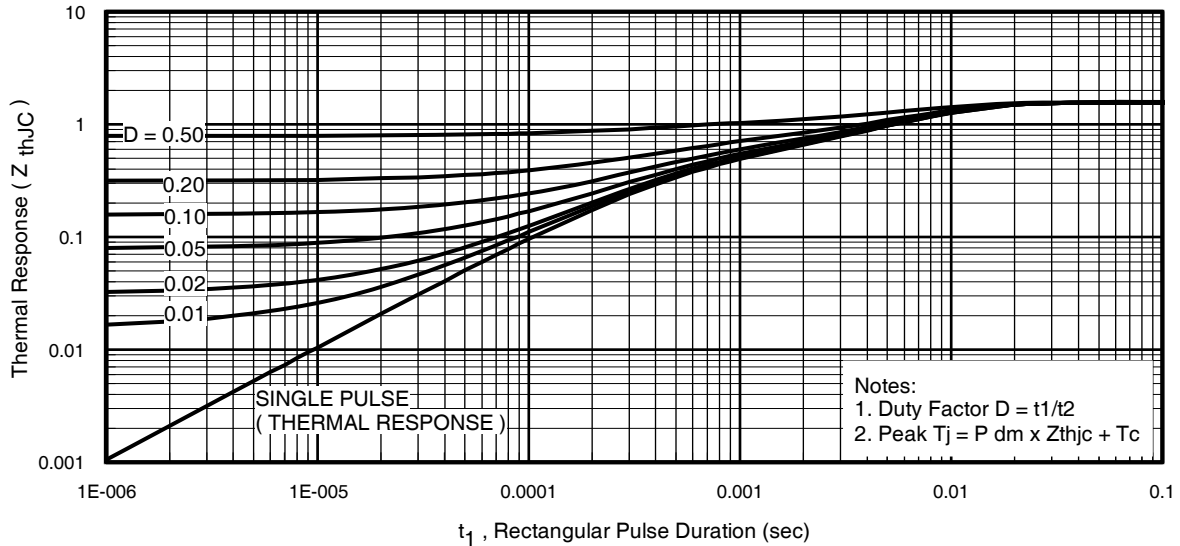

Fig 11. Maximum Effective Transient Thermal Impedance, Junction-to-Case

IRFB812PbF

International
IR Rectifier

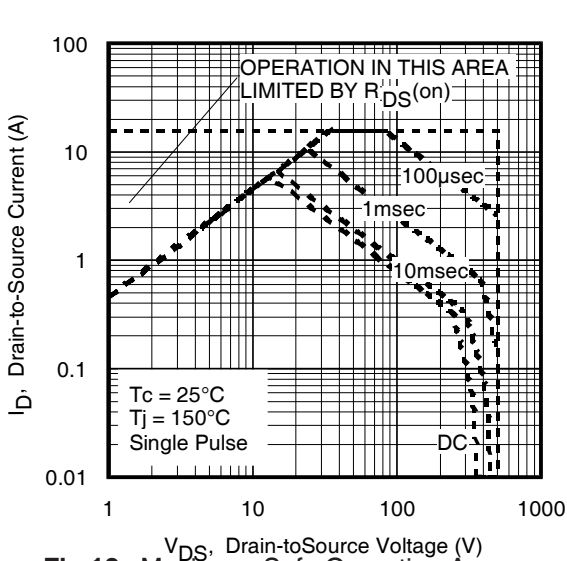

Fig 12. Maximum Safe Operating Area

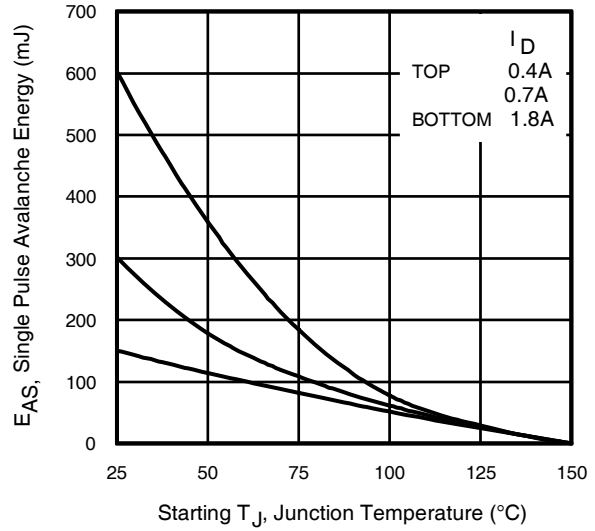

Fig 13. Maximum Avalanche Energy vs. Drain Current

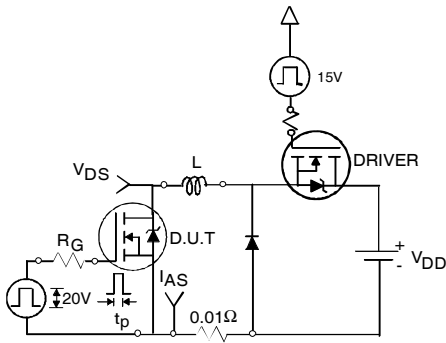

Fig 13a. Unclamped Inductive Test Circuit

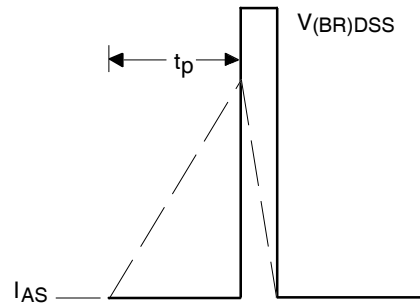

Fig 13b. Unclamped Inductive Waveforms

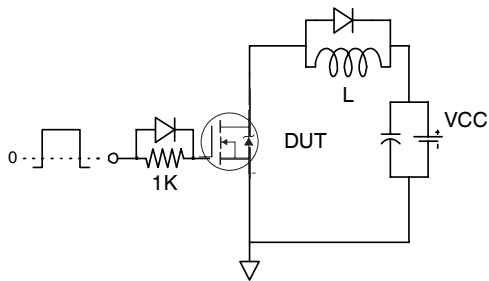

Fig 14a. Gate Charge Test Circuit

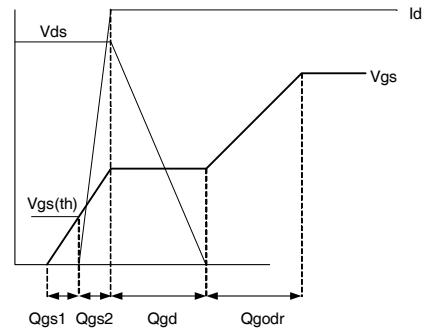

Fig 14b. Gate Charge Waveform

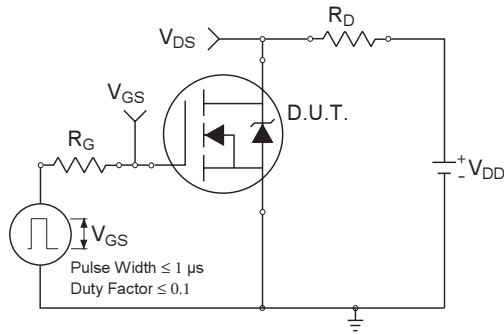

Fig 15a. Switching Time Test Circuit

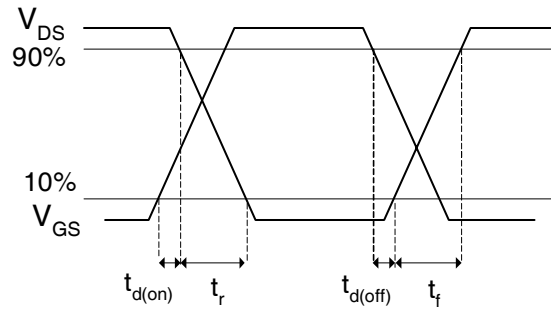
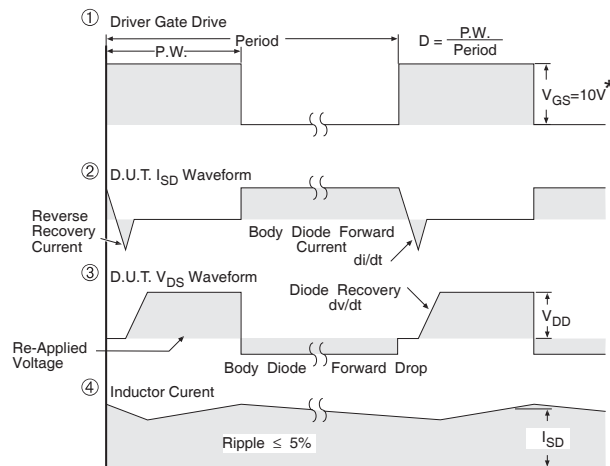
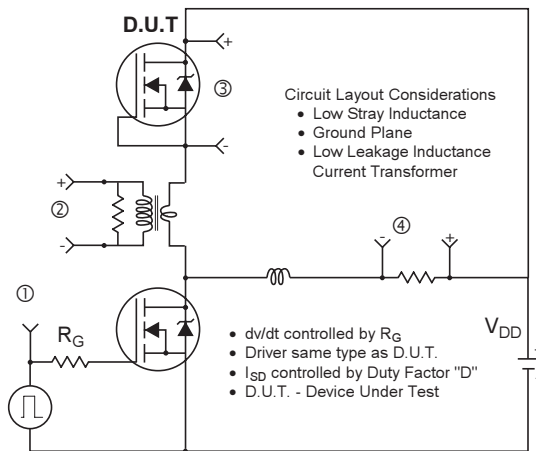

Fig 15b. Switching Time Waveforms



* $V_{GS} = 5V$ for Logic Level Devices

Fig 16. Peak Diode Recovery dv/dt Test Circuit for N-Channel HEXFET[®] Power MOSFETs

IRFB812PbF

TO-220AB Package Outline

Dimensions are shown in millimeters (inches)

International
IR Rectifier

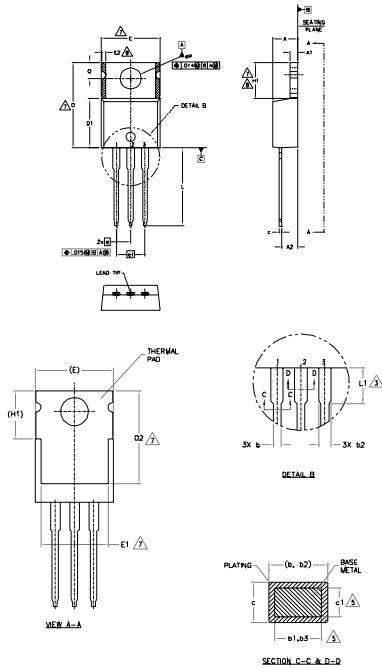

- NOTES:
- 1.- DIMENSIONING AND TOLERANCING AS PER ASME Y14.5 M- 1994.
 - 2.- DIMENSIONS ARE SHOWN IN INCHES (MILLIMETERS).
 - 3.- LEAD DIMENSION AND FINISH UNCONTROLLED IN LT.
 - 4.- DIMENSION D1, D1 & E DO NOT INCLUDE WELD FLASH; WELD FLASH SHALL NOT EXCEED .005" (0.127) PER SIDE. THESE DIMENSIONS ARE MEASURED AT THE OUTERMOST EXTREMES OF THE PLASTIC BODY.
 - 5.- DIMENSION B1, B2 & C1 APPLY TO BASE METAL ONLY.
 - 6.- CONTROLLING DIMENSION - INCHES.
 - 7.- THERMAL PAD CONTOUR OPTIONAL WITHIN DIMENSIONS E1, D2 & E1.
 - 8.- DIMENSION E2 X H1 DEFINE A ZONE WHERE STAMPING AND SIMULATION IRREGULARITIES ARE ALLOWED.
 - 9.- OUTLINE CONFORMS TO JEDEC TO-220, EXCEPT A2 (max.) AND D2 (min.) WHERE DIMENSIONS ARE DERIVED FROM THE ACTUAL PACKAGE OUTLINE.

SYMBOL	DIMENSIONS				NOTES
	MILLIMETERS		INCHES		
	MIN.	MAX.	MIN.	MAX.	
A	3.56	4.83	.140	.190	
A1	0.51	1.40	.020	.056	
A2	2.03	2.92	.080	.115	
b	0.38	1.01	.015	.040	
b1	0.38	0.97	.015	.038	5
b2	1.14	1.78	.045	.070	
b3	1.14	1.73	.045	.068	5
c	0.36	0.61	.014	.024	
c1	0.36	0.56	.014	.022	5
D	14.22	16.51	.560	.650	4
D1	8.38	9.02	.330	.355	
D2	11.58	12.88	.460	.507	7
E	9.65	10.67	.380	.420	4,7
E1	6.86	8.89	.270	.350	7
E2	-	0.76	-	.030	8
e	2.54	2.54	.100	.100	
e1	0.76	0.76	.030	.030	
H1	5.84	6.86	.230	.270	7,8
L	12.70	14.75	.500	.580	
L1	3.56	4.06	.140	.160	5
MP	3.54	4.08	.139	.161	
Q	2.54	3.42	.100	.135	

- LEAD ASSIGNMENTS
- 1.- GATE
 - 2.- DIODE
 - 3.- SOURCE
- WELD SYMBOLS
- 1.- GATE
 - 2.- DIODE
 - 3.- EMITTER
- DOSES
- 1.- INCH
 - 2.- MILLIMETER
 - 3.- INCH

TO-220AB Part Marking Information

EXAMPLE: THIS IS AN IRF1010
LOT CODE 1789
ASSEMBLED ON WW 19, 2000
IN THE ASSEMBLY LINE "C"

Note: "P" in assembly line position
indicates "Lead - Free"

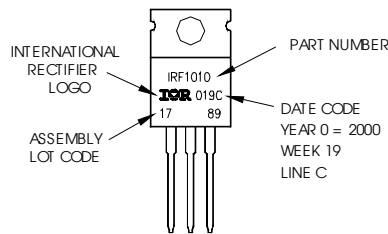

TO-220AB packages are not recommended for Surface Mount Application.

Note: For the most current drawing please refer to IR website at <http://www.irf.com/package/>

Data and specifications subject to change without notice.
This product has been designed and qualified for the Industrial market.
Qualification Standards can be found on IR's Web site.

International
IR Rectifier

IR WORLD HEADQUARTERS: 233 Kansas St., El Segundo, California 90245, USA Tel: (310) 252-7105
TAC Fax: (310) 252-7903

Visit us at www.irf.com for sales contact information.06/11

www.irf.com

IMPORTANT NOTICE

The information given in this document shall in no event be regarded as a guarantee of conditions or characteristics ("Beschaffheitsgarantie").

With respect to any examples, hints or any typical values stated herein and/or any information regarding the application of the product, Infineon Technologies hereby disclaims any and all warranties and liabilities of any kind, including without limitation warranties of non-infringement of intellectual property rights of any third party.

In addition, any information given in this document is subject to customer's compliance with its obligations stated in this document and any applicable legal requirements, norms and standards concerning customer's products and any use of the product of Infineon Technologies in customer's applications.

The data contained in this document is exclusively intended for technically trained staff. It is the responsibility of customer's technical departments to evaluate the suitability of the product for the intended application and the completeness of the product information given in this document with respect to such application.

For further information on the product, technology, delivery terms and conditions and prices please contact your nearest Infineon Technologies office (www.infineon.com).

WARNINGS

Due to technical requirements products may contain dangerous substances. For information on the types in question please contact your nearest Infineon Technologies office.

Except as otherwise explicitly approved by Infineon Technologies in a written document signed by authorized representatives of Infineon Technologies, Infineon Technologies' products may not be used in any applications where a failure of the product or any consequences of the use thereof can reasonably be expected to result in personal injury.