

Application Note AN-1116

IRS2112 and IR2112 Comparison

By Jason Nguyen, Min Fang, David New

Table of Contents

	Page
Introduction	1
Block Diagrams	2
Electrical Characteristic Differences.....	2
Figures	3
Summary.....	10

Introduction

The IRS2112 is a new HVIC product that replaces the IR2112 HVICs and is pin-to-pin compatible with its corresponding predecessor. In many cases, little or no change is necessary to use the new products. This application note describes the various differences between the IRS2112 and the IR2112 HVICs.

The IRS2112 is a high voltage, high speed power MOSFET and IGBT driver with independent high and low side referenced output channels. Proprietary HVIC and latch immune CMOS technologies enable ruggedized monolithic construction. Logic inputs are compatible with standard CMOS or LSTTL outputs, down to 3.3 V logic. The output drivers feature a high pulse current buffer stage designed for minimum driver cross-conduction. The floating channel can be used to drive an N-channel power MOSFET or IGBT in the high side configuration which operates up to 600 V.

Block Diagrams

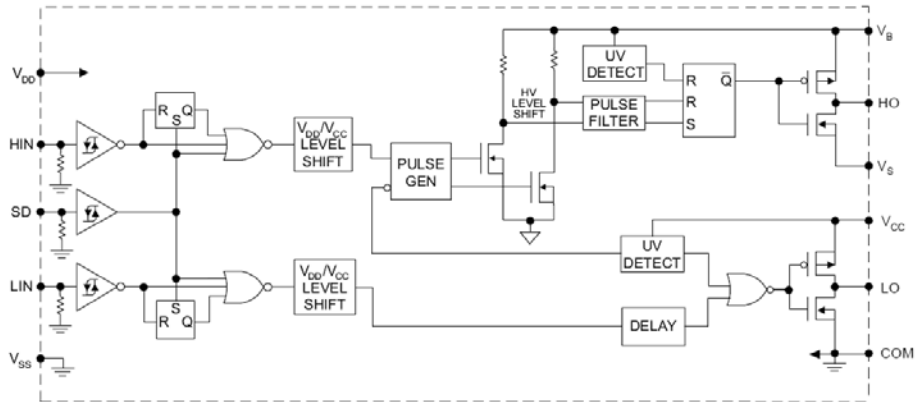

The IRS2112 and IR2112 share the same block diagram. There are no functional changes between corresponding part numbers.

Electrical Characteristic Differences

All measurement conditions remain unchanged unless noted. Parameters not mentioned in this document have not changed.

Absolute Maximum Ratings

There are no changes in the Absolute Maximum Ratings.

Recommended Operating Conditions

There are no changes in the Recommended Operating Conditions.

Dynamic Electrical Characteristics

Parameter		IR2112		IRS2112		Units
Symbol	Definition	typ	max	typ	max	
t_{on}	Turn-on Propagation Delay ($V_s = 0\text{ V}$)	125	180	135	180	ns
t_{off}	Turn-off Propagation Delay ($V_s = 600\text{ V}$)	105	160	130	160	
t_{sd}	Shutdown Propagation Delay ($V_s = 600\text{ V}$)	105	160	130	160	
t_r	Turn-on rise time ($V_s = 0\text{ V}$)	80	130	75	130	
t_f	Turn-off fall time ($V_s = 0\text{ V}$)	40	65	35	65	

The IRS2112 has increased propagation delay and faster rise and fall times when compared to the IR2112.

Static Electrical Characteristics

Parameter		IR2112			IRS2112			Units
Symbol	Definition	min	typ	max	min	typ	max	
V_{OH}	High level output voltage, $V_{BIAS} - V_O$	-	-	0.1	-	0.05	0.2	V
		I _o = 0 mA			I _o = 2 mA			
V_{OL}	Low level output voltage, V_O	-	-	0.1	-	0.02	0.1	
		I _o = 0 mA			I _o = 2 mA			
I_{O+}	Output high short circuit pulsed current ($V_O = 0\text{ V}$, $V_{IN} = V_{DD}$, $PW \leq 10\mu s$)	200	250	-	200	290	-	mA
I_{O-}	Output low short circuit pulsed current ($V_O = 15\text{ V}$, $V_{IN} = 0\text{ V}$, $PW \leq 10\mu s$)	420	500	-	420	600	-	

With the IRS2112,

1. The V_{OH} and V_{OL} are tested using a new standardized test condition of $I_{O} = 2\text{ mA}$. The output driver's on resistance is slightly lower for IRS2112.
2. The typical values for I_{O+} and I_{O-} are higher, which allows faster switching.

Figures

This figures shown in this section compare figures shown in the IR2112 (left column) and IRS2112 (right column) datasheets. Illustrations that have not changed between the two datasheets have not been included in this section.

IR2112	IRS2112
---------------	----------------

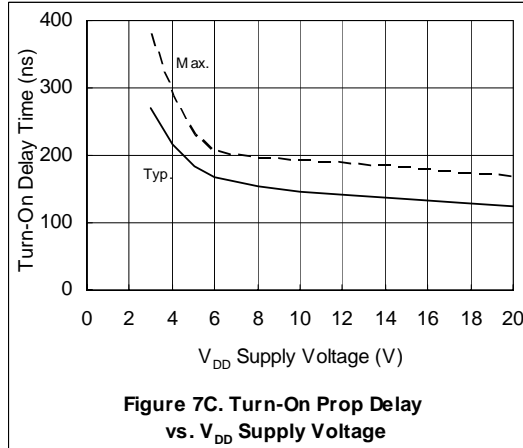
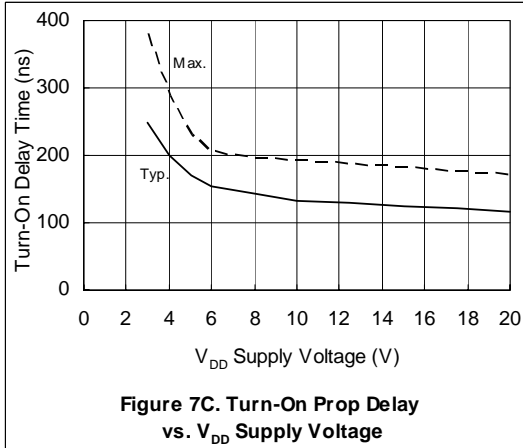
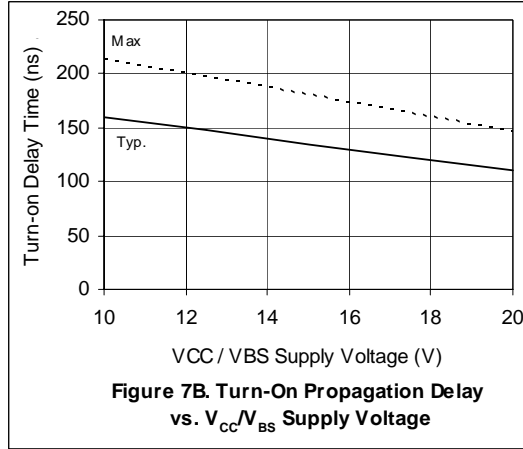
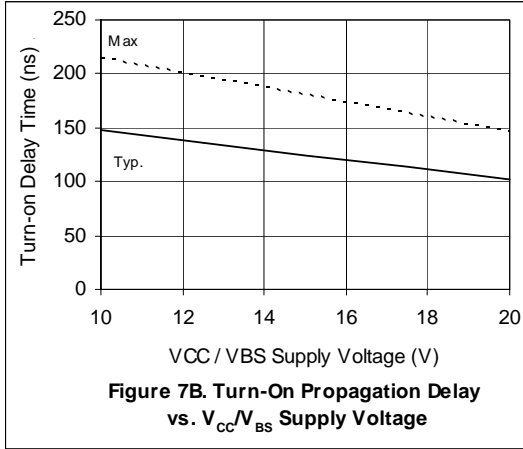
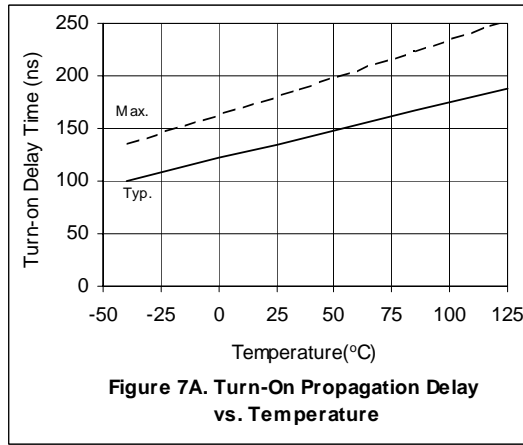
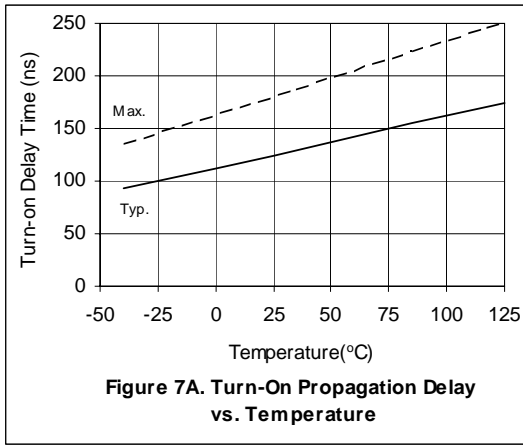

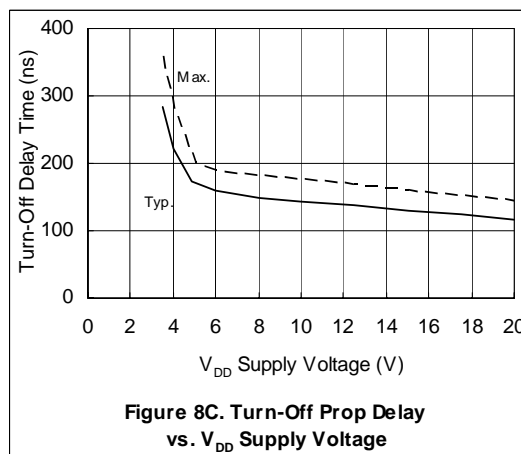
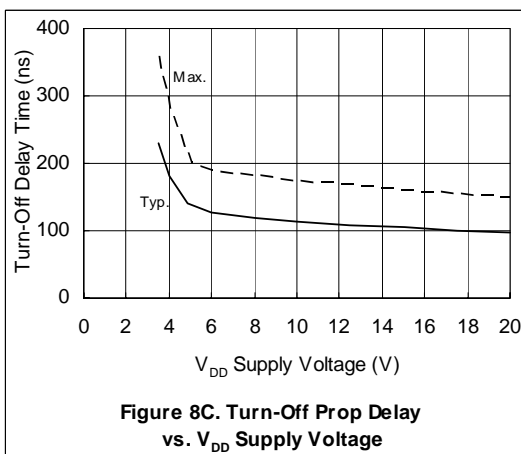
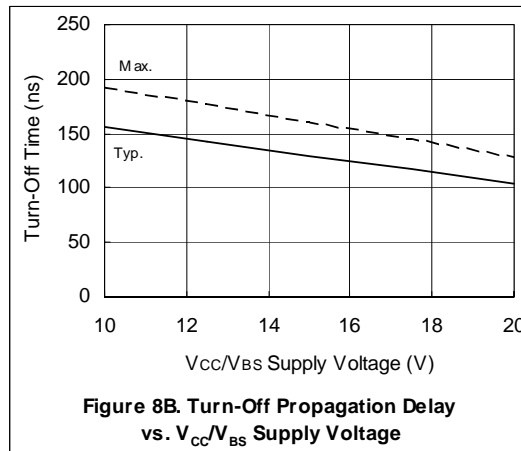
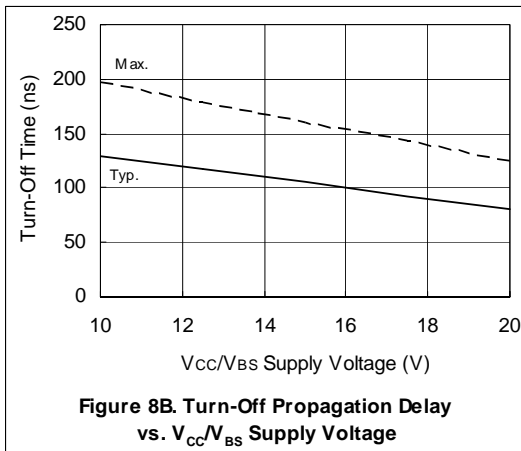
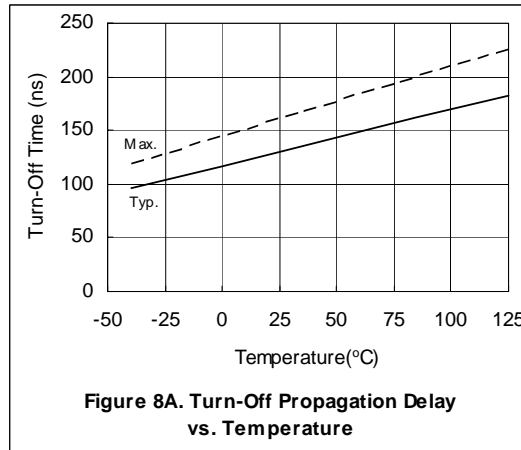
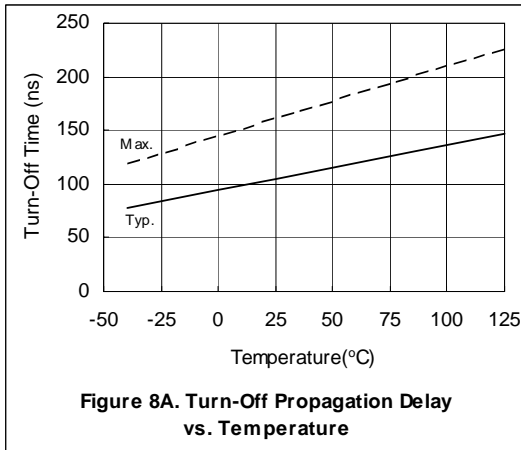

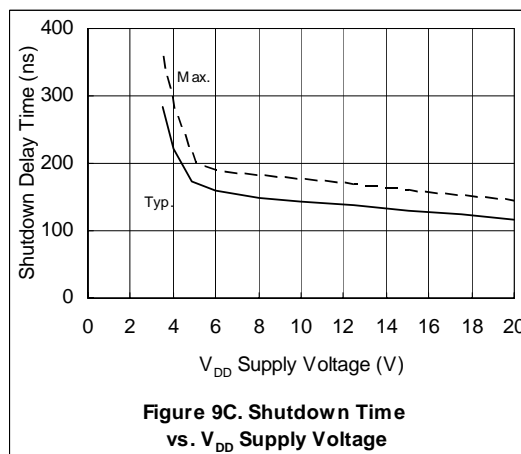
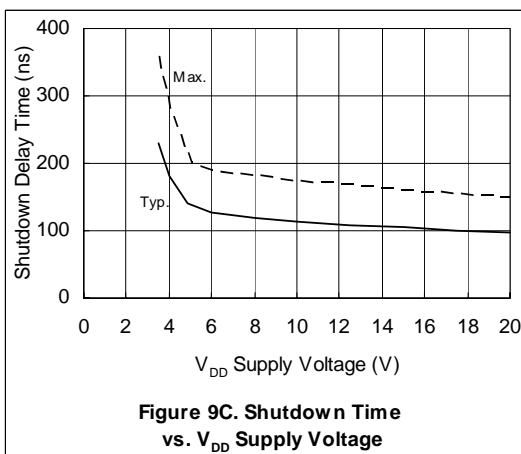
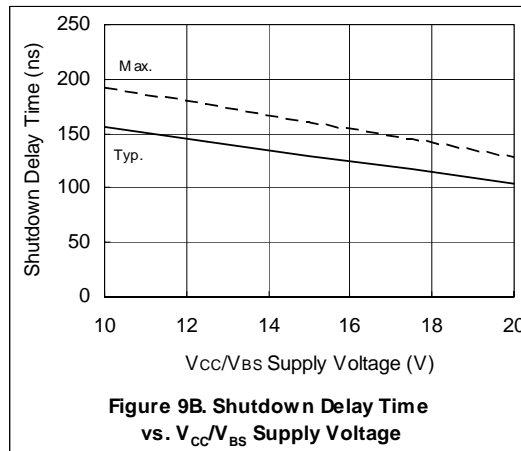
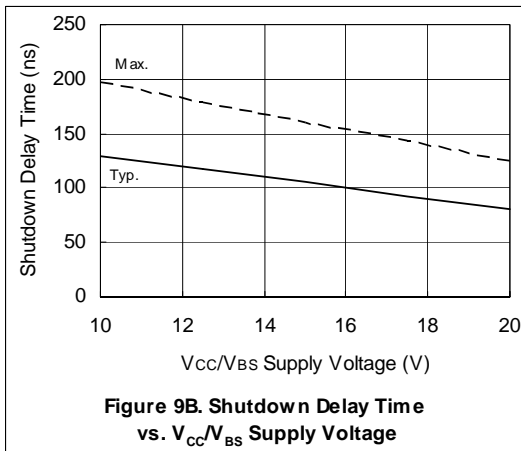
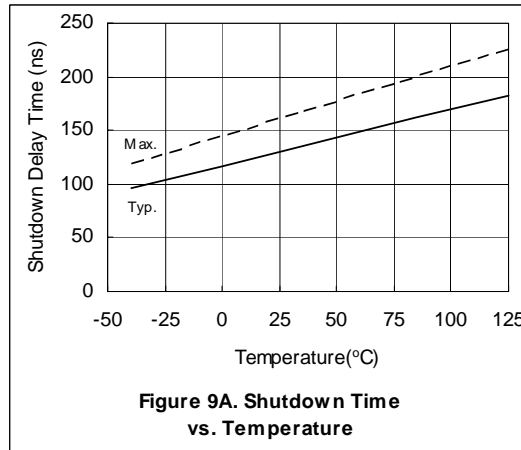
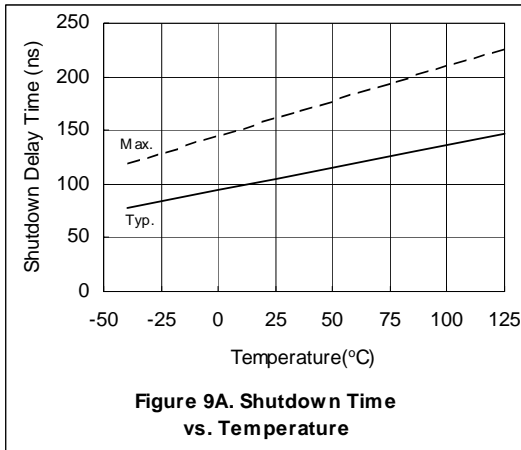

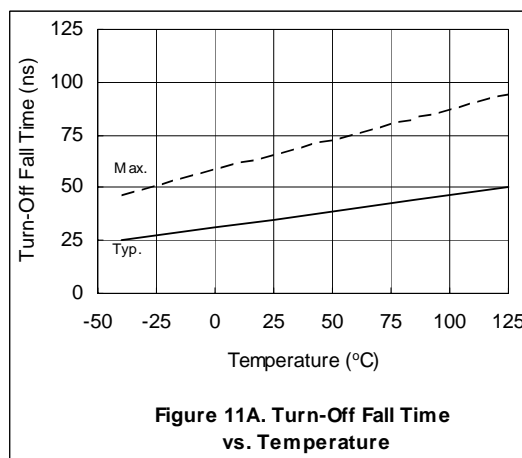
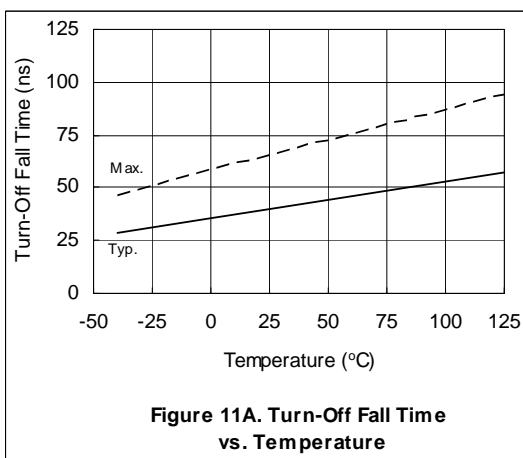
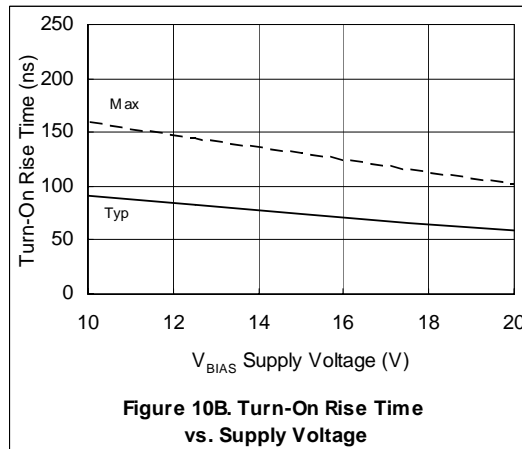
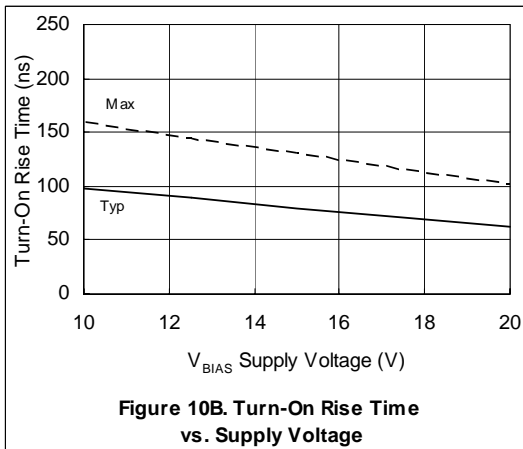
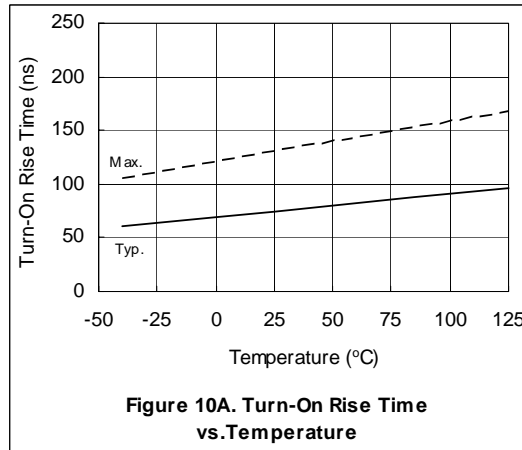
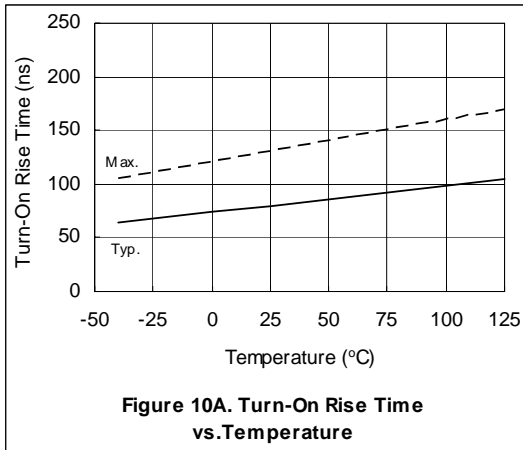

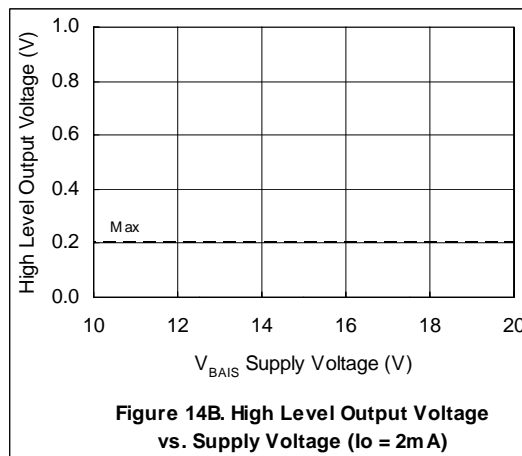
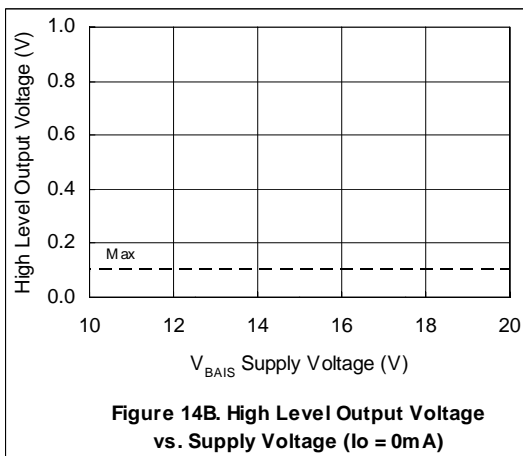
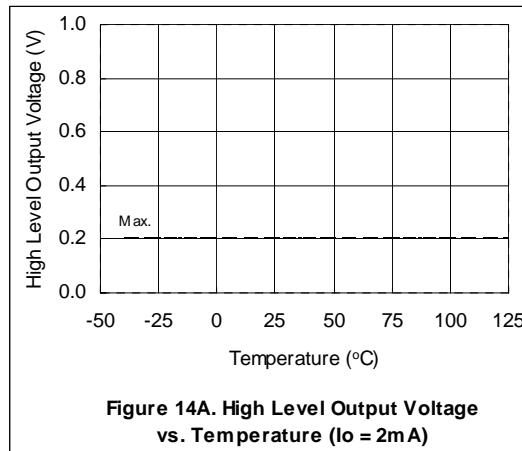
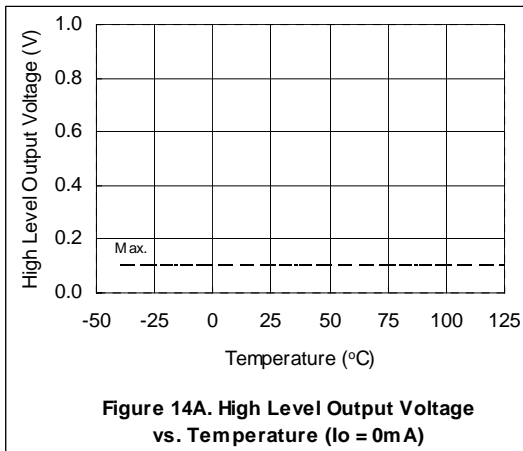
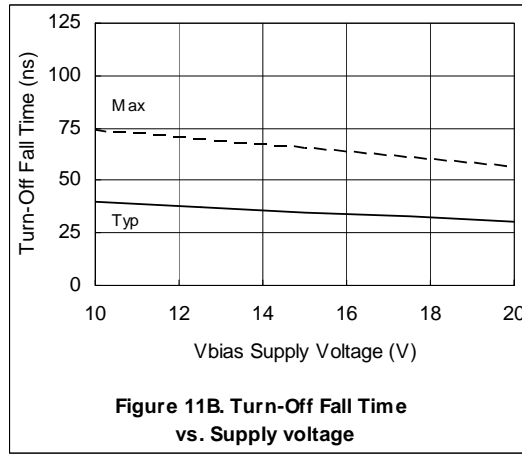
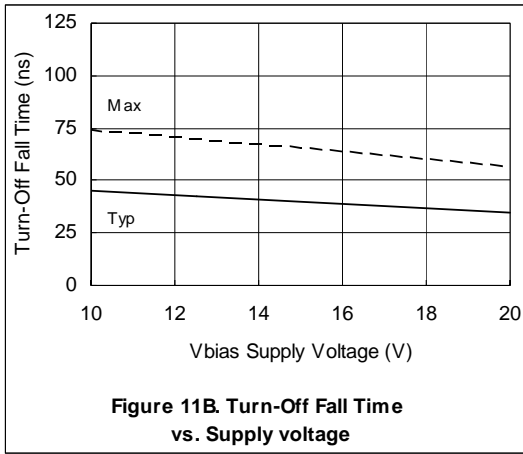

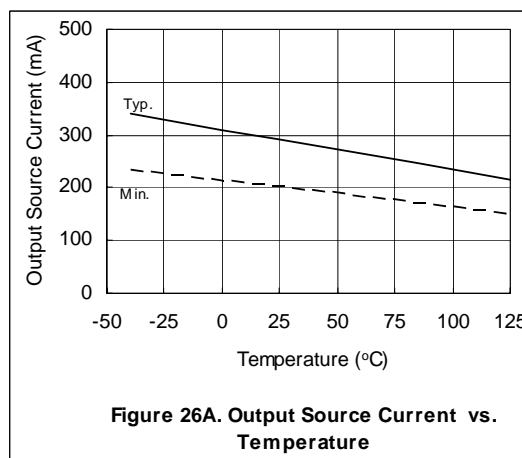
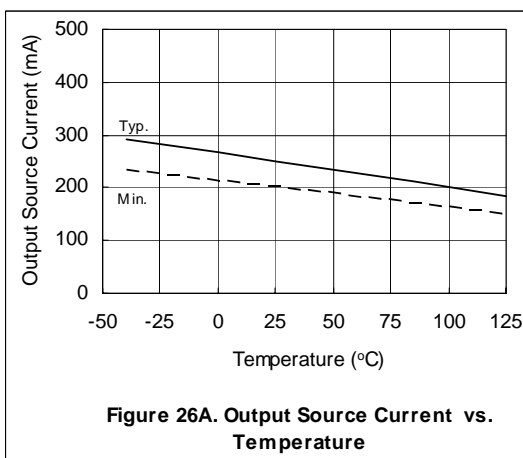
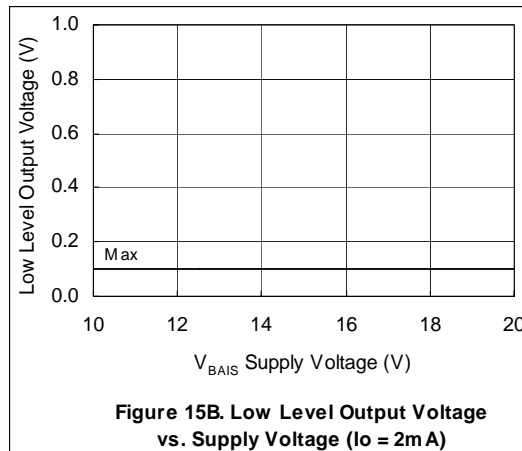
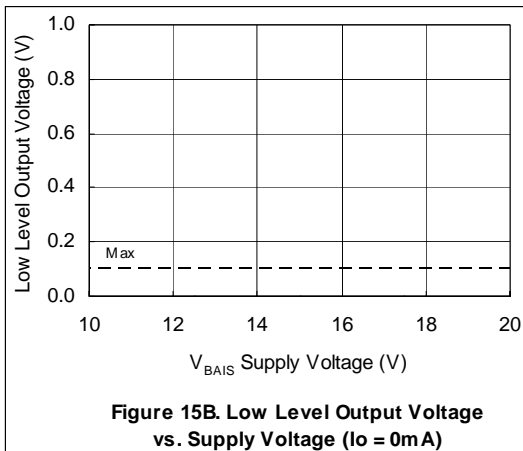
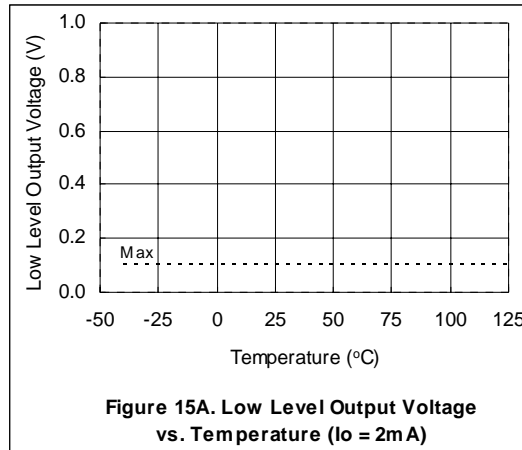
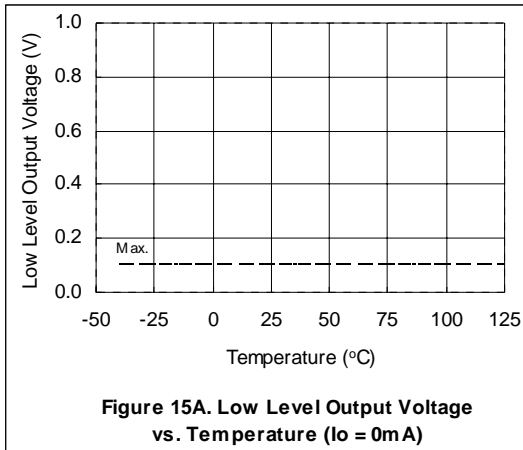

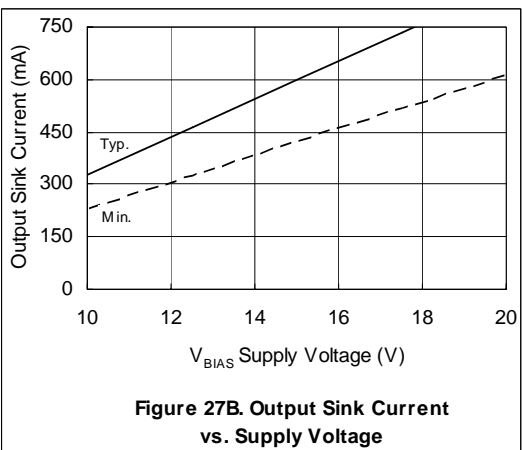
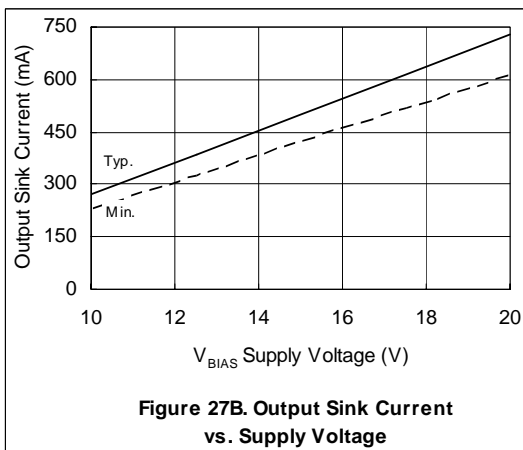
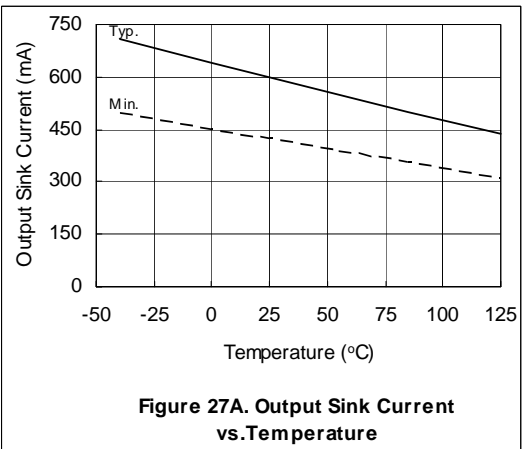
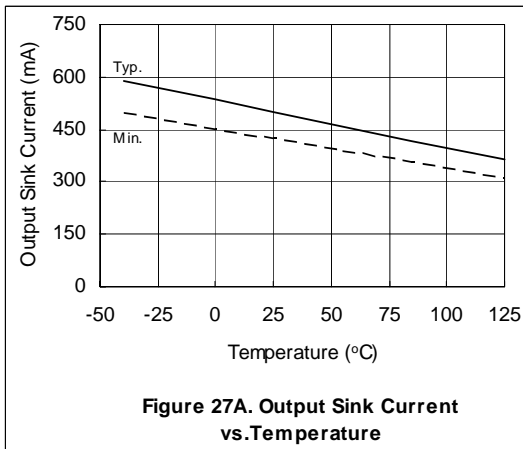
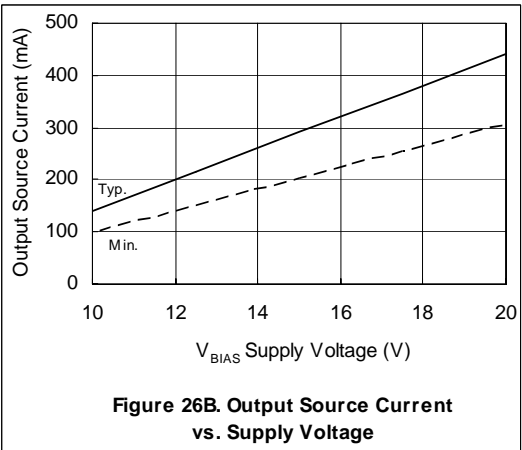
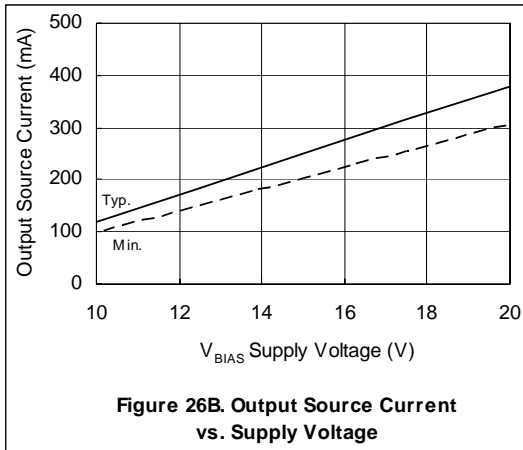

Summary

As shown by this document, the IRS2112 and the IR2112 are very similar with only a few parametric differences.