

Application Note AN-1112

IRS2304 and IR2304 Comparison

By Jason Nguyen, Min Fang, David New

Table of Contents

	Page
Introduction	1
Block Diagrams	2
Electrical Characteristic Differences.....	2
Summary.....	7

Introduction

The IRS2304 is a new HVIC product that replaces the IR2304 HVICs and is pin-to-pin compatible with its corresponding predecessor. In many cases, little or no change is necessary to use the new product. This application note describes the various differences between the IRS2304 and the IR2304 HVICs.

The IRS2304 is a high voltage, high speed power MOSFET and IGBT drivers with independent high and low side referenced output channels. Proprietary HVIC and latch immune CMOS technologies enable ruggedized monolithic construction. The logic input is compatible with standard CMOS or LSTTL output, down to 3.3V logic. The output driver features a high pulse current buffer stage designed for minimum driver cross-conduction. The floating channel can be used to drive an N-channel power MOSFET or IGBT in the high side configuration which operates up to 600 V.

Block Diagrams

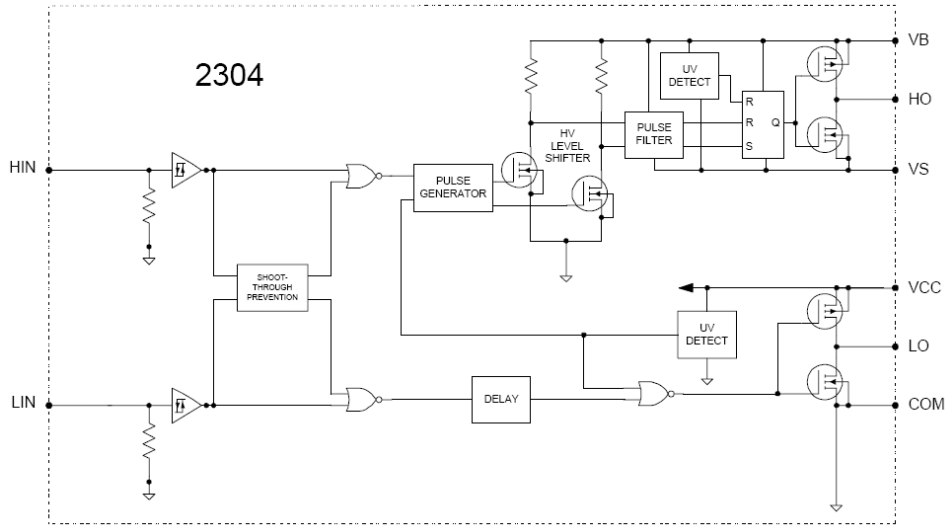

The IRS2304 and IR2304 share the same block diagram. There are no functional changes between corresponding part numbers.

Electrical Characteristic Differences

All measurement conditions remain unchanged unless noted. Parameters not mentioned in this document have not changed.

Absolute Maximum Ratings

There are no changes in the Absolute Maximum Ratings.

Recommended Operating Conditions

There are no changes in the Recommended Operating Conditions.

Static Electrical Characteristics

V_{OH}	High level output voltage, $V_{BIAS} - V_o$ ($I_o = 20$ mA)	-	-	2.8	-	0.05	0.2	V
		I _o = 20 mA			I _o = 2 mA			
V_{OL}	Low level output voltage, V_o ($I_o = 20$ mA)	-	-	1.2	-	0.02	0.1	V
		I _o = 20 mA			I _o = 2 mA			
I_{o+}	Output high short circuit pulsed current ($V_o = 0$ V, $V_{IN} = \text{Logic "1"}$, $PW \leq 10$ μ s)	60	-	-	60	290	-	mA
I_{o-}	Output low short circuit pulsed current ($V_o = 15$ V, $V_{IN} = \text{Logic "0"}$, $PW \leq 10$ μ s)	130	-	-	130	600	-	

With the IRS2304,

1. The V_{OH} and V_{OL} are tested using a new standardized test condition of $I_o = 2$ mA. The output driver's R_{ON} is lower for the IRS2304, which improves immunity against the Miller effect.
2. The typical values for I_{o+} and I_{o-} are higher, which allows faster switching

Dynamic Electrical Characteristics

Parameter		IR2304			IRS2304			Units
Symbol	Definition	min	typ	max	min	typ	max	
t_{on}	Turn-on propagation delay ($V_s = 0$ V)	120	220	320	90	150	210	ns
t_{off}	Turn-off propagation delay ($V_s = 0$ V or 600 V)	130	220	330	90	150	210	
t_r	Turn-on rise time	60	200	300	-	70	120	
t_f	Turn-off fall time	20	100	170	-	35	50	

The IRS2304 has faster rise and fall times when compared to the IR2304.

Figures

This figures shown in this section compare figures shown in the IR2304 (left column) and IRS2304 (right column) datasheets. Illustrations that have not changed between the two datasheets have not been included in this section.

IR2304

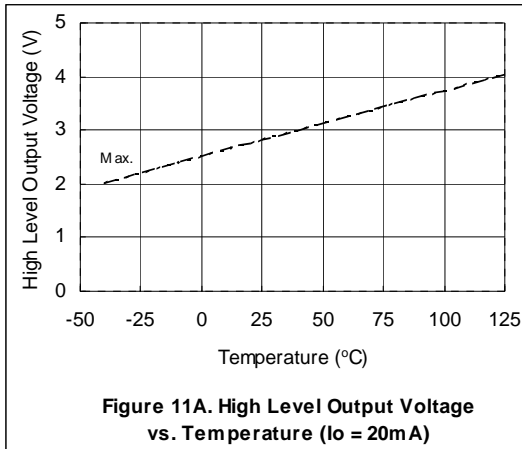

IRS2304

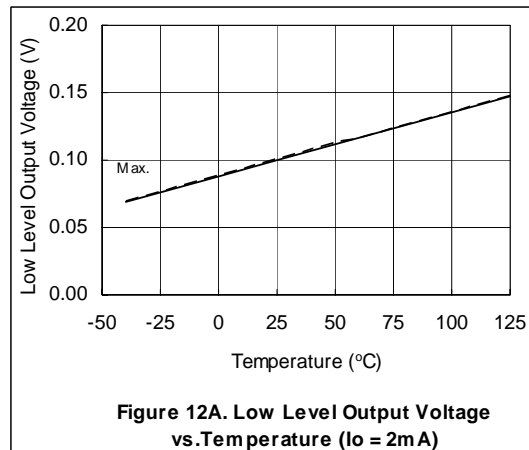
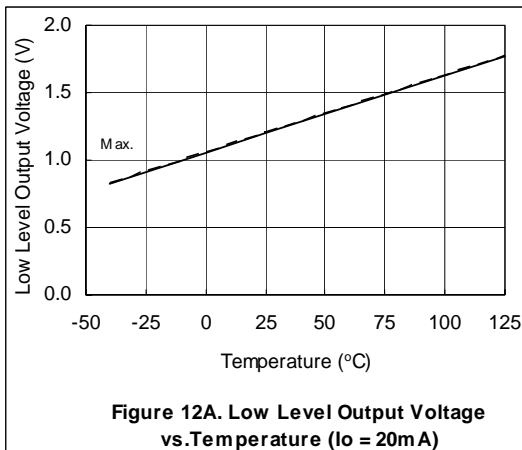
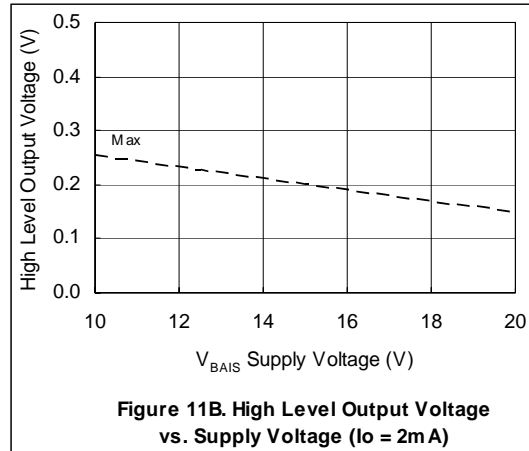
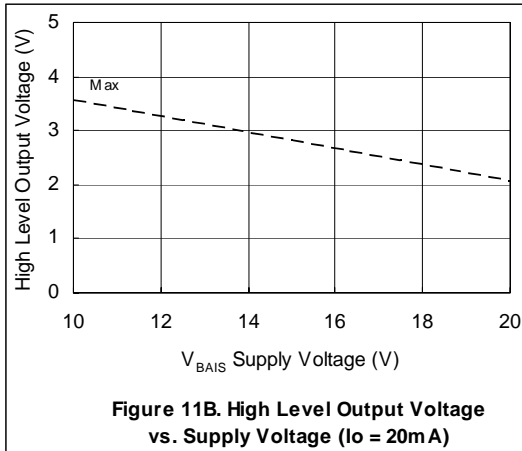
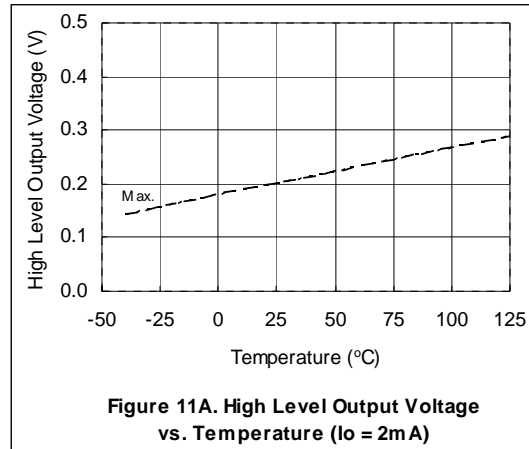

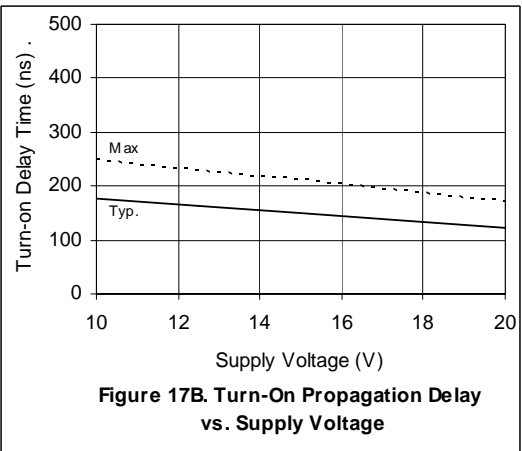
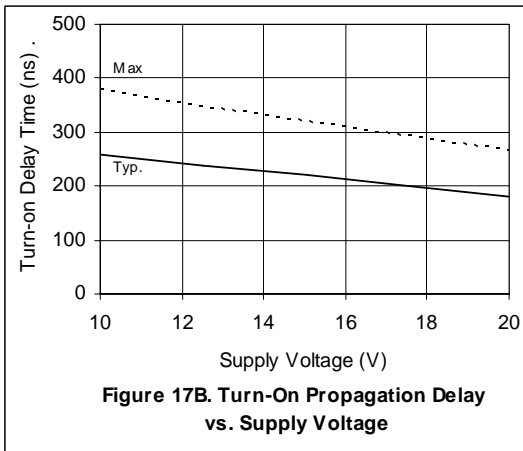
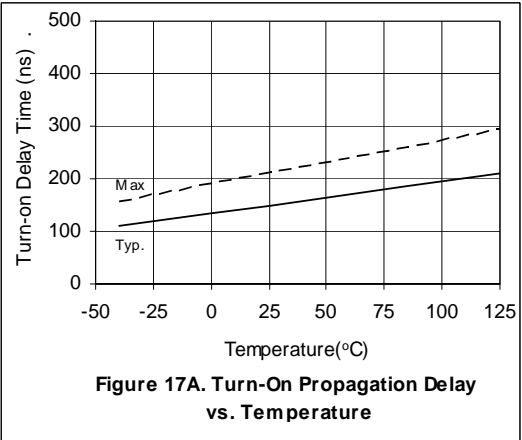
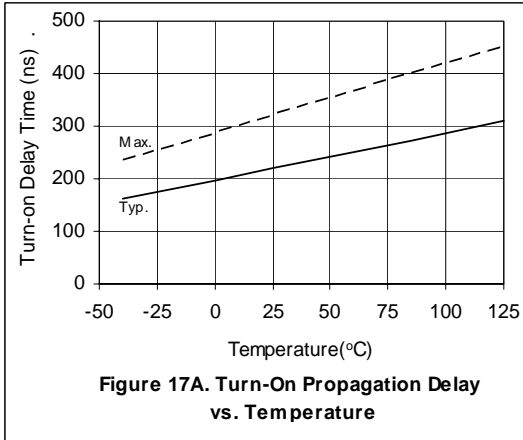
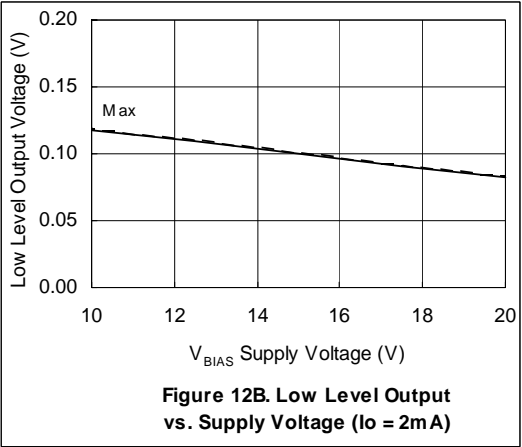
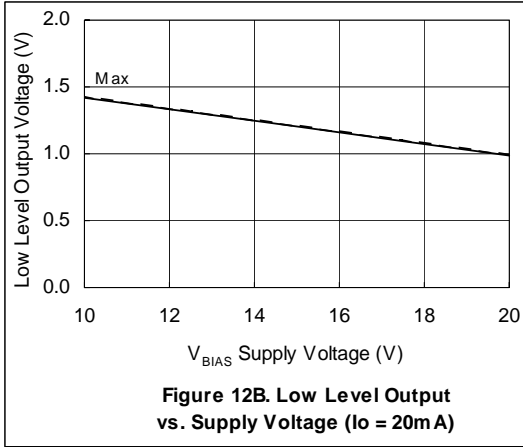

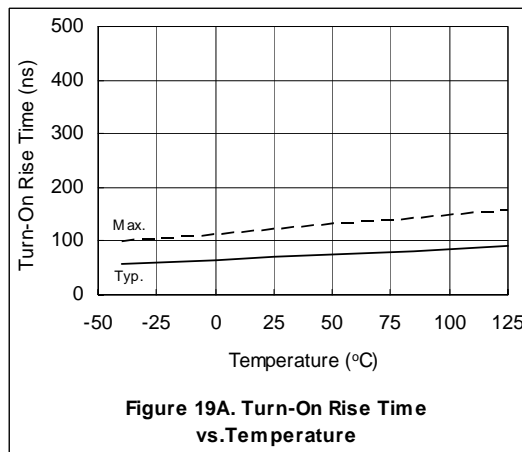
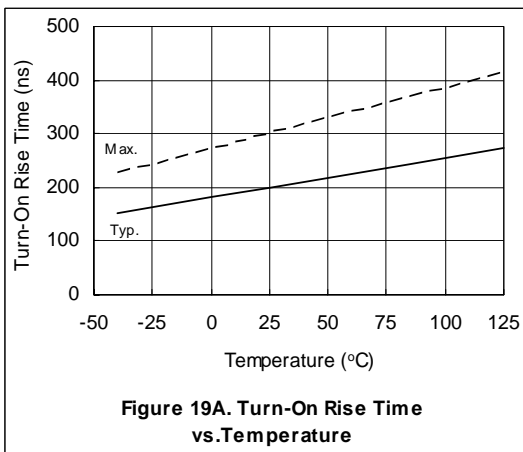
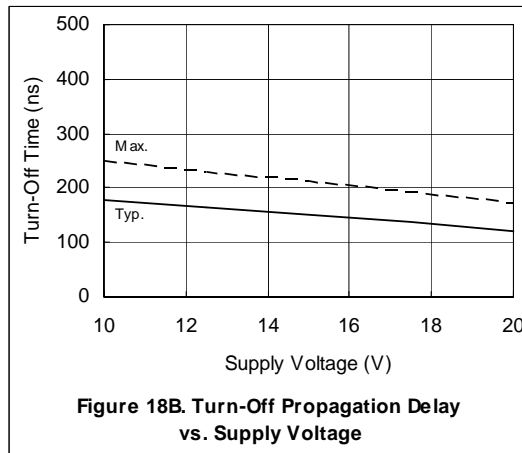
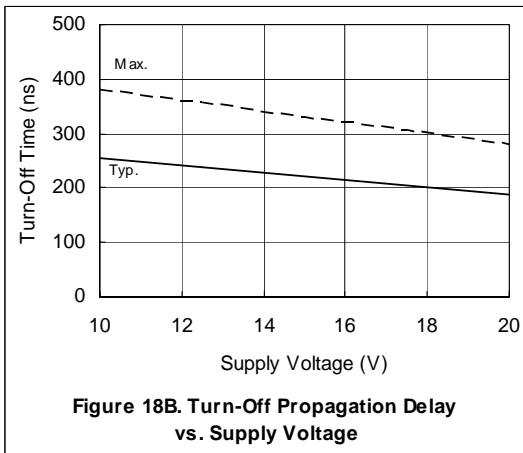
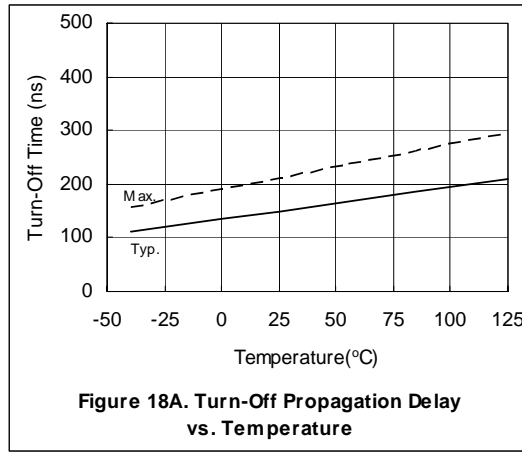
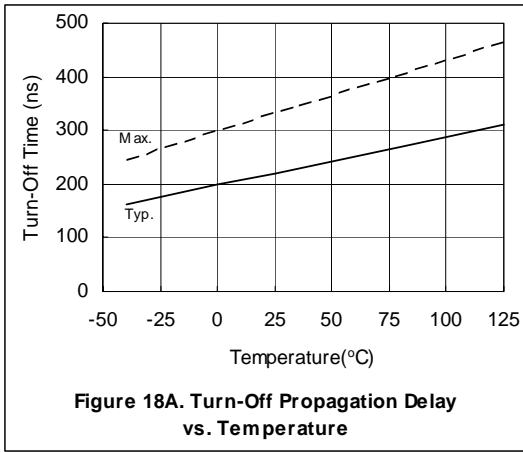

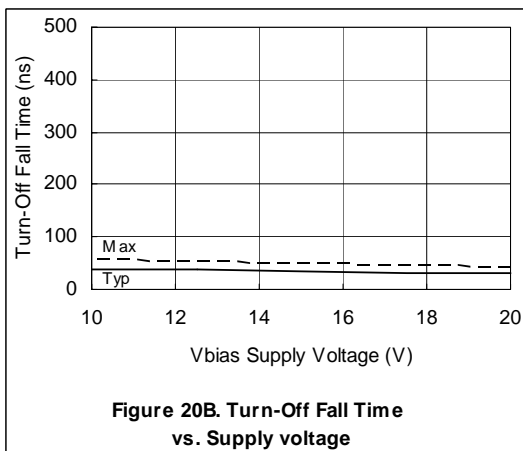
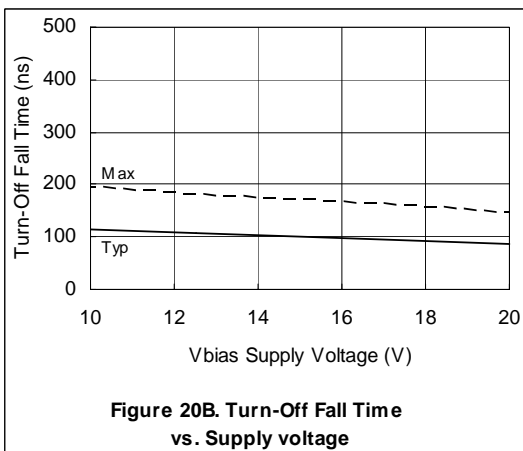
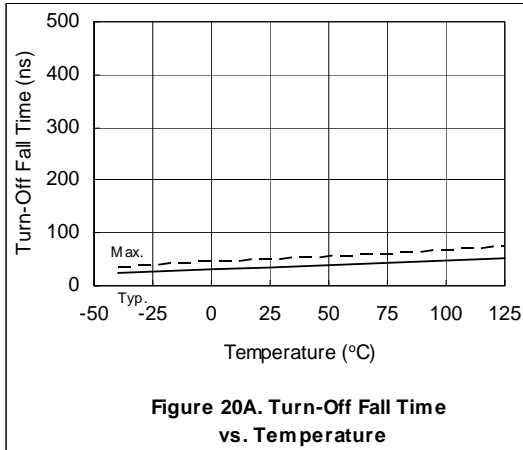
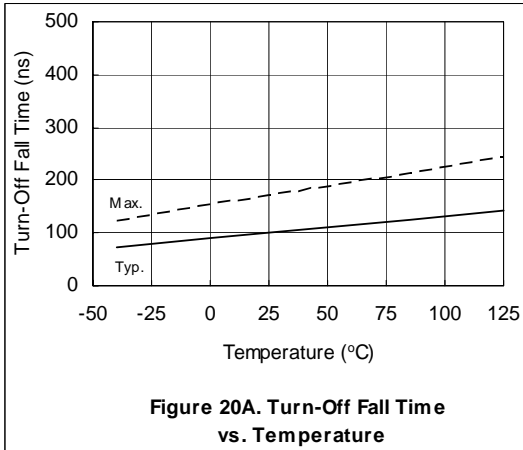
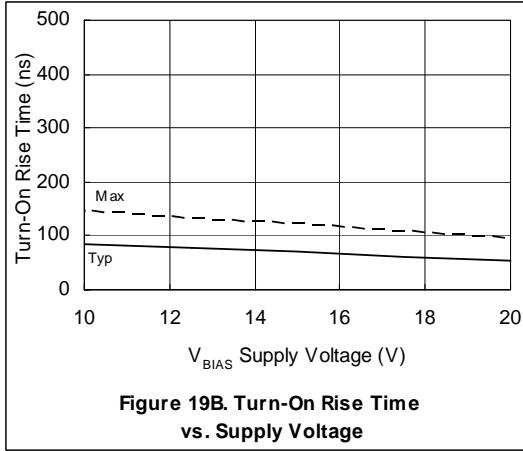
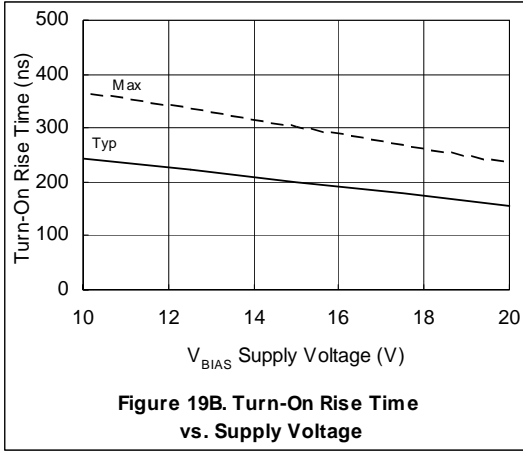

Summary

As shown by this document, the IRS2304 and the IR2304 are very similar with only a few negligible parametric differences.