

Application Note AN-1103

IRS2103 and IR2103 Comparison

By Jason Nguyen, Min Fang, David New

Table of Contents

	Page
Introduction	1
Block Diagram.....	2
Electrical Characteristic Differences.....	3
Figures	3
Summary.....	8

Introduction

The IRS2103 is a new HVIC product that replaces the IR2103 and is pin-to-pin compatible with its corresponding predecessor. In many cases, little or no change is necessary to use the new product. This application note describes the various differences between the IRS2103 and the IR2103 HVICs.

The IRS2103 is a high voltage, high speed power MOSFET and IGBT driver with independent high and low side referenced output channels. Proprietary HVIC and latch immune CMOS technologies enable ruggedized monolithic construction. The logic input is compatible with standard CMOS or LSTTL outputs, down to 3.3 V logic. The output drivers feature a high pulse current buffer stage designed for minimum driver cross-conduction. The floating channel can be used to drive an N-channel power MOSFET or IGBT in the high side configuration which operates up to 600 V.

Block Diagram

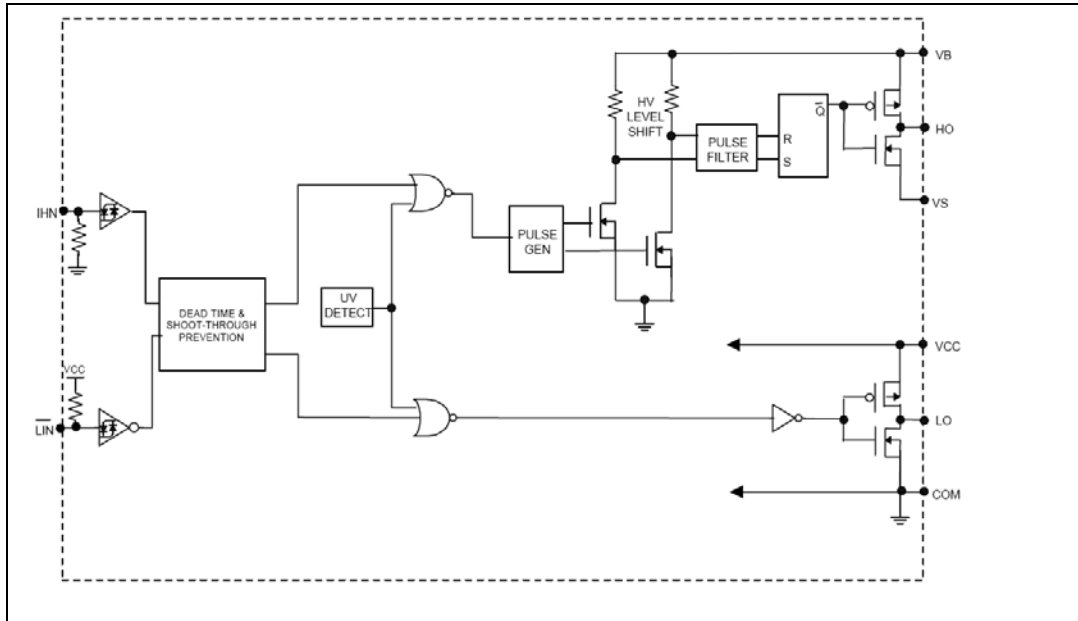

The IRS2103 and the IR2103 share the same block diagram. The functionality of the two ICs is the same.

Electrical Characteristic Differences

All measurement conditions remain unchanged unless noted. Parameters not mentioned in this document have not changed.

Absolute Maximum Ratings

There are no changes in the Absolute Maximum Ratings.

Recommended Operating Conditions

There are no changes in the Recommended Operating Conditions.

Dynamic Electrical Characteristics

Parameter		IR2103		IRS2103		Units
Symbol	Definition	typ	max	typ	max	
t_r	Turn-on rise time	100	170	70	170	ns
t_f	Turn-off fall time	50	90	35	90	

The IRS2103 has faster rise and fall times when compared to the IR2103.

Static Electrical Characteristics

Parameter		IR2103			IRS2103			Units
Symbol	Definition	min	typ	max	min	typ	max	
V_{IH}	Logic "1" input voltage ($V_{CC} = 10\text{ V to }20\text{ V}$)	3	-	-	2.5	-	-	V
V_{IL}	Logic "0" input voltage ($V_{CC} = 10\text{ V to }20\text{ V}$)	-	-	0.8	-	-	0.8	
V_{OH}	High level output voltage, $V_{BIAS} - V_O$	-	-	0.1	-	0.05	0.2	
V_{OL}	Low level output voltage, V_O	-	-	0.1	-	0.02	0.1	
		I _o = 0 mA			I _o = 2 mA			
I_{O+}	Output high short circuit pulsed current ($V_O = 0\text{ V}$, $V_{IN} = \text{Logic "1"}$, $PW \leq 10\mu\text{s}$)	130	210	-	130	290	-	mA
I_{O-}	Output low short circuit pulsed current ($V_O = 15\text{ V}$, $V_{IN} = \text{Logic "0"}$, $PW \leq 10\mu\text{s}$)	270	360	-	270	600	-	

With the IRS2103,

- V_{IH} has been reduced to 2.5 V for better 3.3 V logic compatibility.
- The V_{OH} and V_{OL} are tested using a new standardized test condition of $I_o = 2\text{ mA}$. The output driver's on resistance is lower for IRS2103, which improves immunity against the Miller effect.
- The typical values for I_{O+} and I_{O-} are increased, which allows faster switching.

Figures

This figures shown in this section compare figures shown in the IR2103 (left column) and IRS2103 (right column) datasheets. Illustrations that have not changed between the two datasheets have not been included in this section.

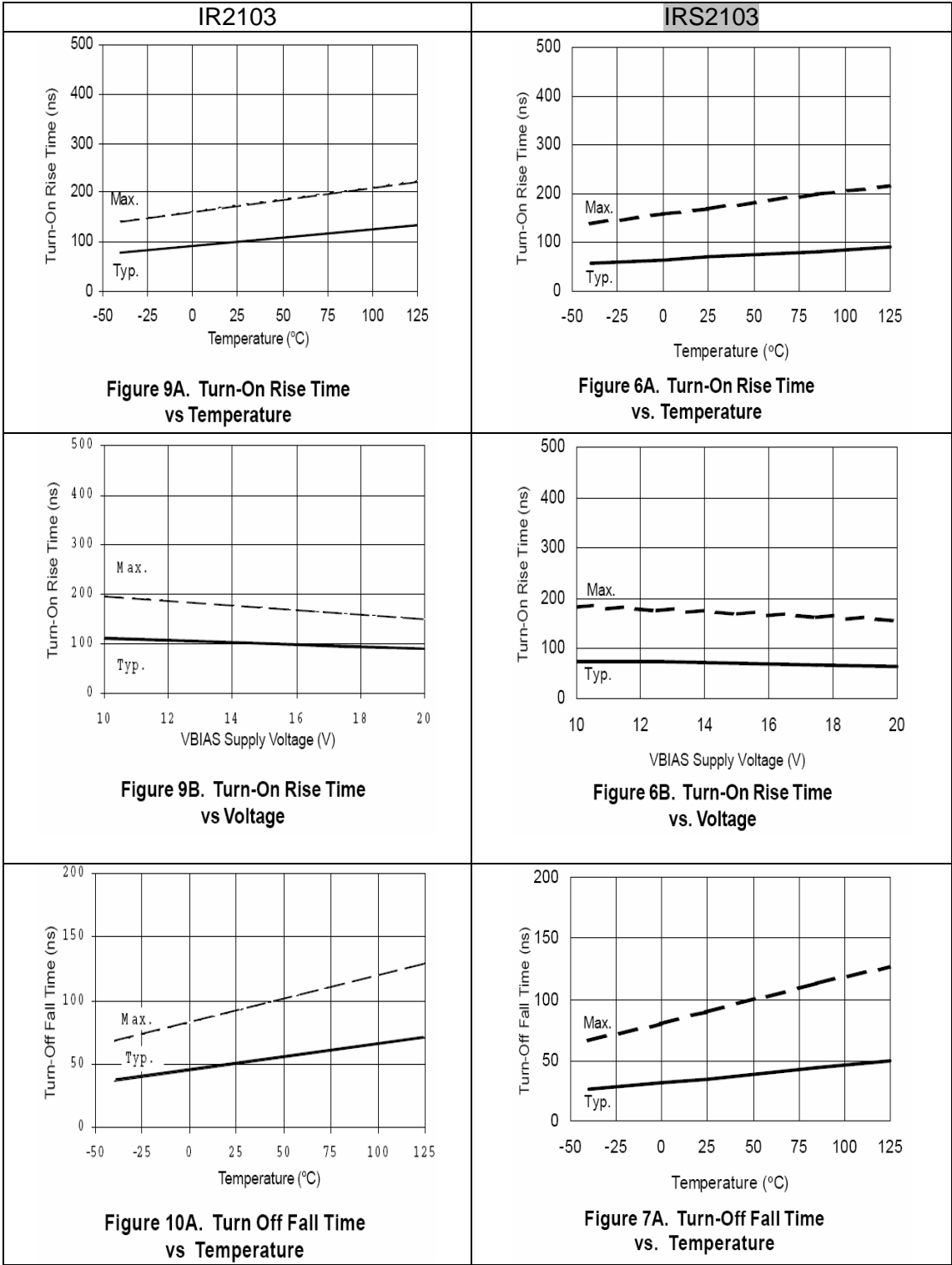

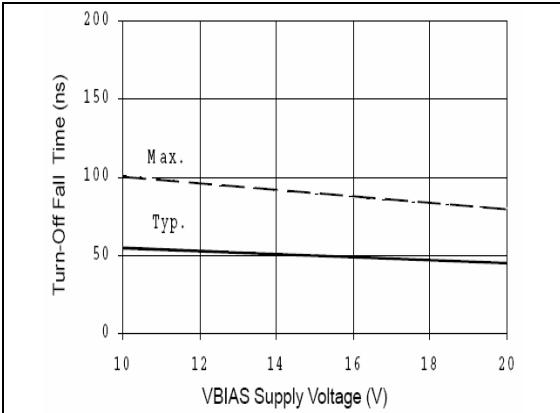

Figure 10B. Turn Off Fall Time vs Voltage

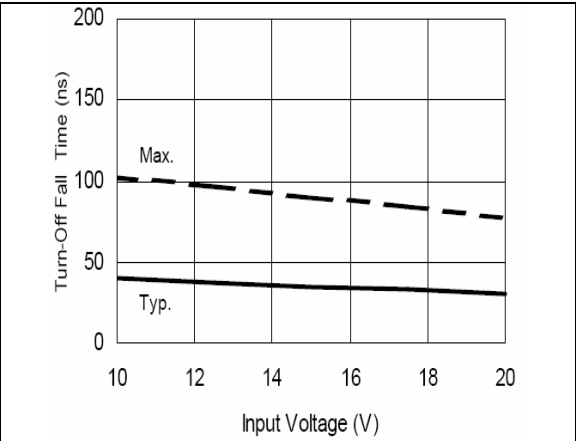

Figure 7B. Turn-Off Fall Time vs. Voltage

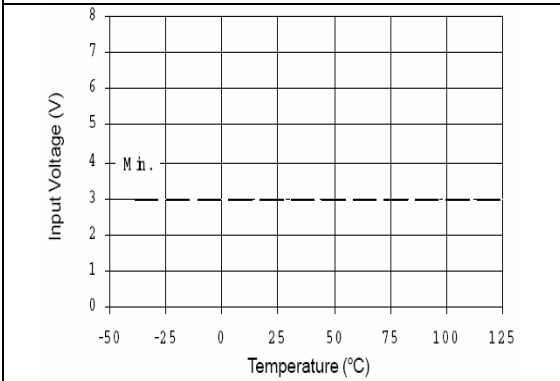

Figure 12A. Logic "1" (\overline{HIN}) & Logic "0" (\overline{LIN}) Input Voltage vs Temperature

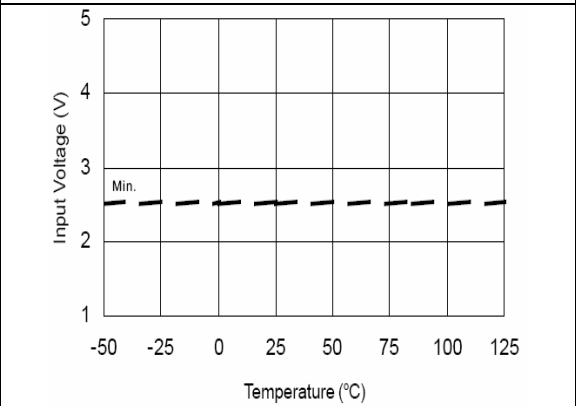

Figure 9A. Logic "1" Input Voltage vs. Temperature

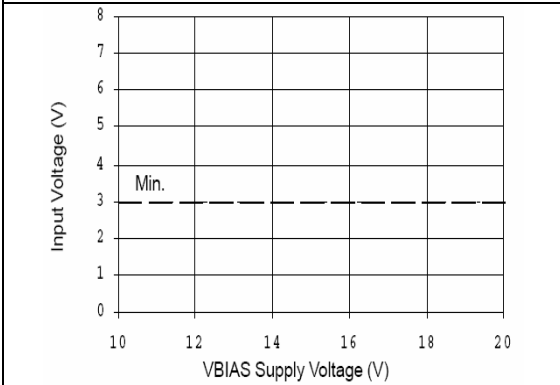

Figure 12B. Logic "1" (\overline{HIN}) & Logic "0" (\overline{LIN}) Input Voltage vs Voltage

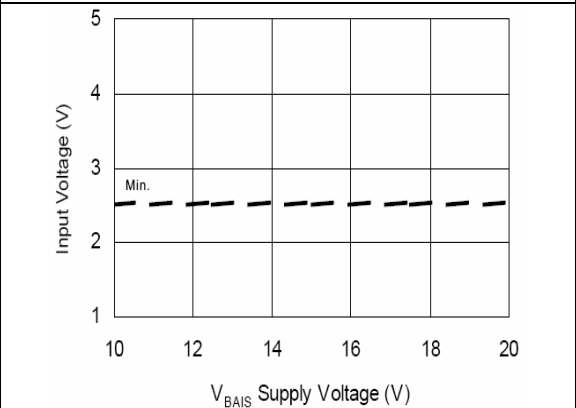

Figure 9B. Logic "1" Input Voltage vs. Supply Voltage

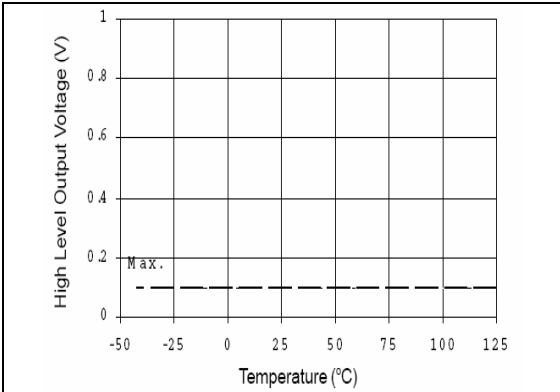

Figure 14A. High Level Output vs Temperature

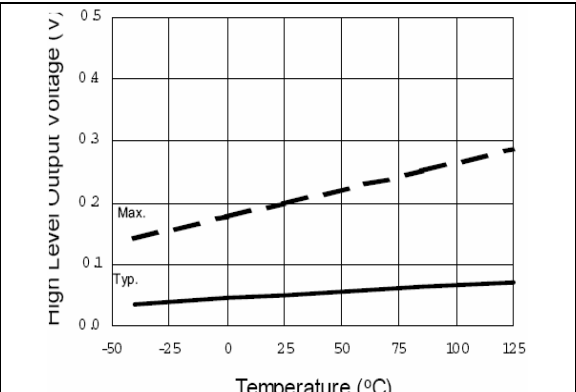

Figure 11A. High Level Output Voltage vs. Temperature

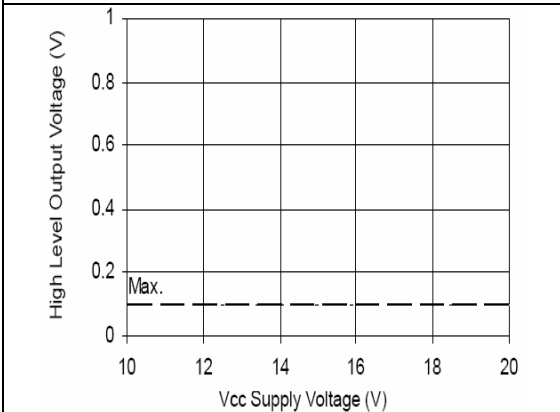

Figure 14B. High Level Output vs Voltage

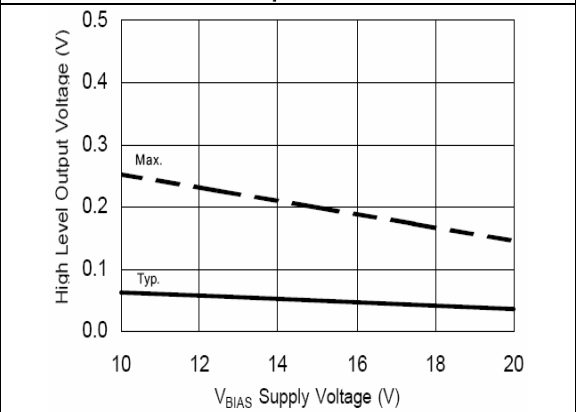

Figure 11B. High Level Output Voltage vs. Supply Voltage

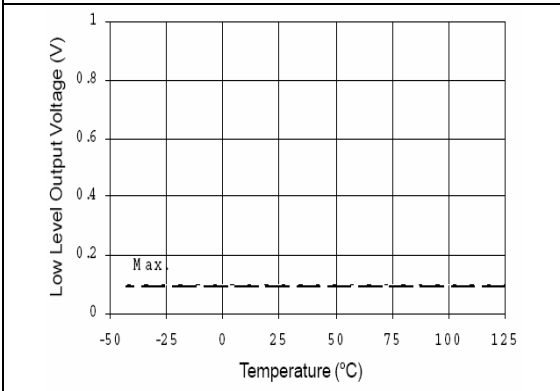

Figure 15A. Low Level Output vs Temperature

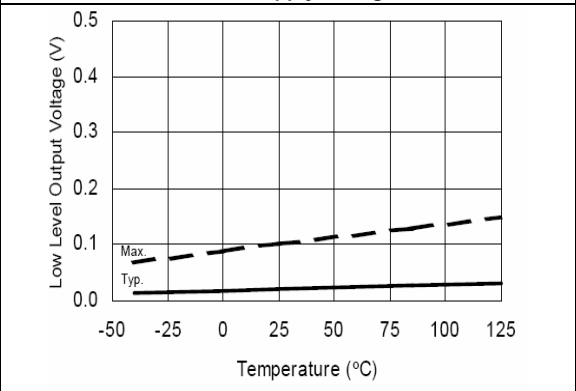

Figure 12A. Low Level Output Voltage vs. Temperature

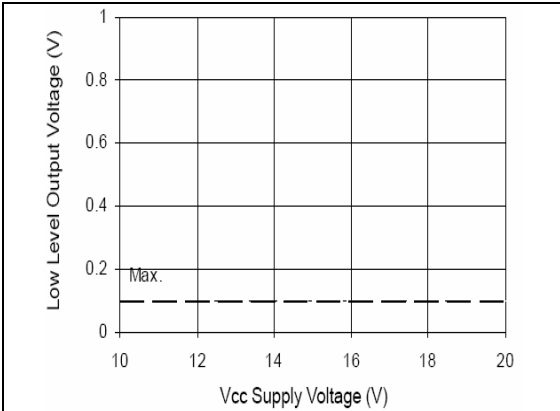

Figure 15B. Low Level Output vs Voltage

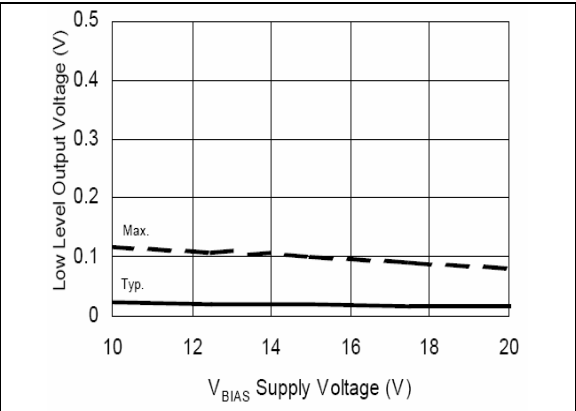

Figure 12B. Low Level Output Voltage vs. Supply Voltage

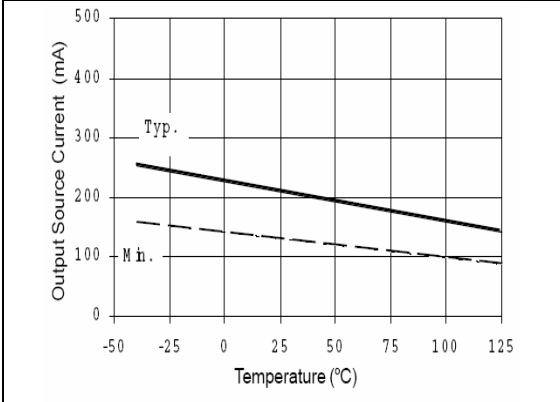

Figure 22A. Output Source Current vs Temperature

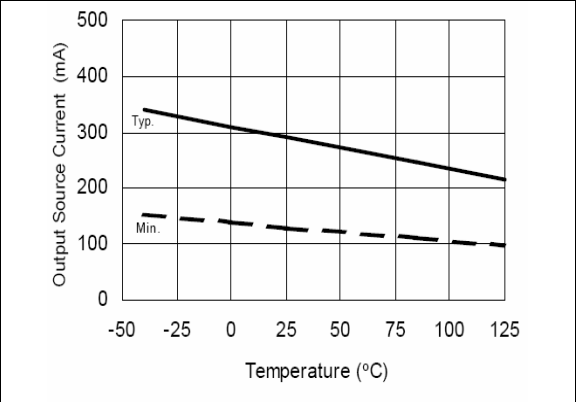

Figure 19A. Output Source Current vs. Temperature

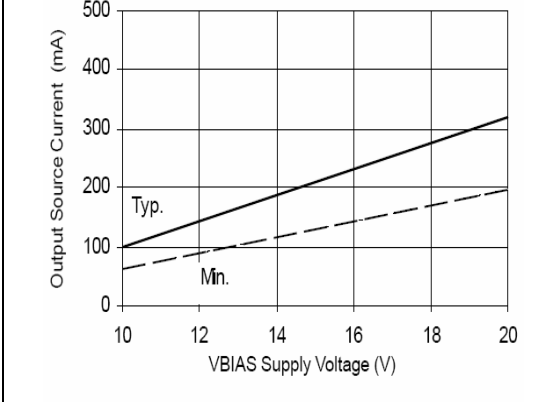

Figure 22B. Output Source Current vs Voltage

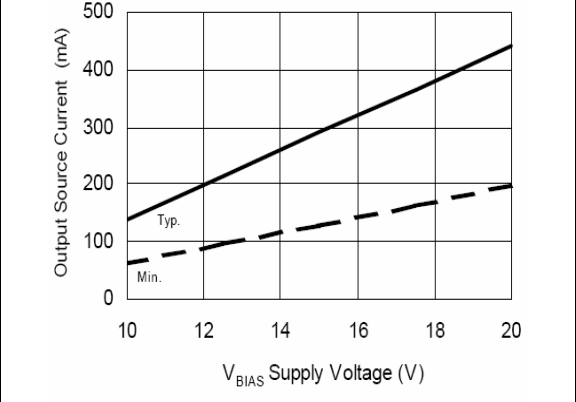
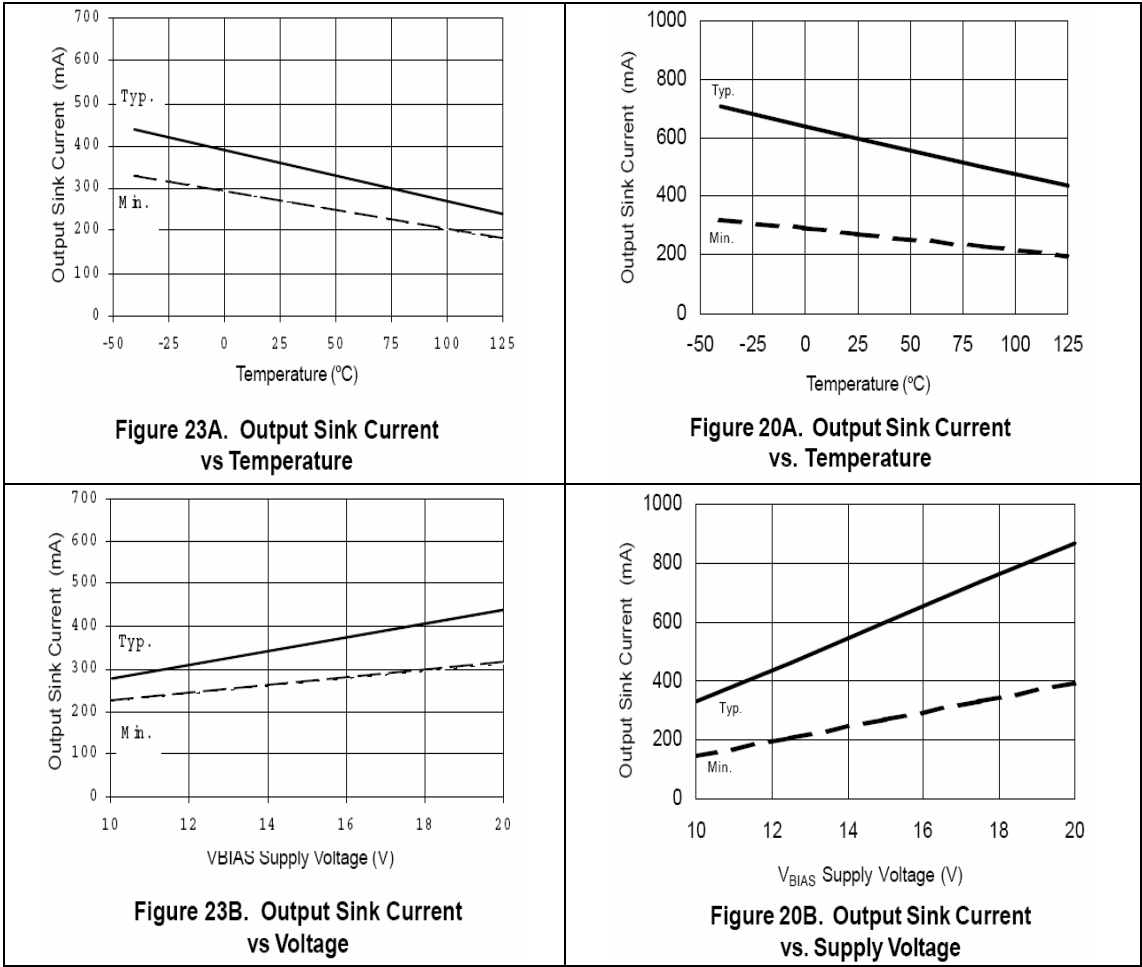

Figure 19B. Output Source Current vs. Supply Voltage



Summary

As shown by this document, the IRS2103 and the IR2103 are very similar with only a few negligible parametric differences.