

Application Note AN-1102

IRS210(9,94) and IR210(9,94) Comparison

By Jason Nguyen, Min Fang, David New

Table of Contents

	Page
Introduction	1
Block Diagrams	2
Electrical Characteristic Differences.....	3
Figures	4
Summary.....	8

Introduction

The IRS210(9,94) are new HVIC products that replace the IR210(9,94) HVICs and are pin-to-pin compatible with their corresponding predecessors. In many cases, little or no change is necessary to use the new products. This application note describes the various differences between the IRS210(9,94) and the IR210(9,94) HVICs.

The IRS210(9,94) are high voltage, high speed power MOSFET and IGBT drivers with independent high and low side referenced output channels. Proprietary HVIC and latch immune CMOS technologies enable ruggedized monolithic construction. The logic input is compatible with standard CMOS or LSTTL outputs, down to 3.3 V logic. The output drivers feature a high pulse current buffer stage designed for minimum driver cross-conduction. The floating channel can be used to drive an N-channel power MOSFET or IGBT in the high side configuration which operates up to 600 V.

Block Diagrams

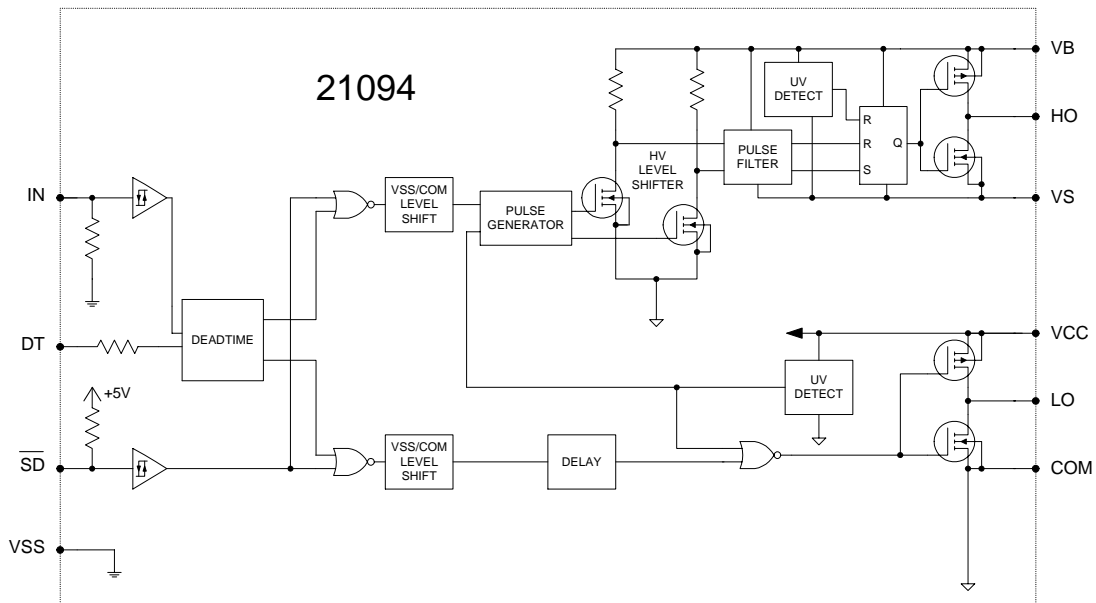
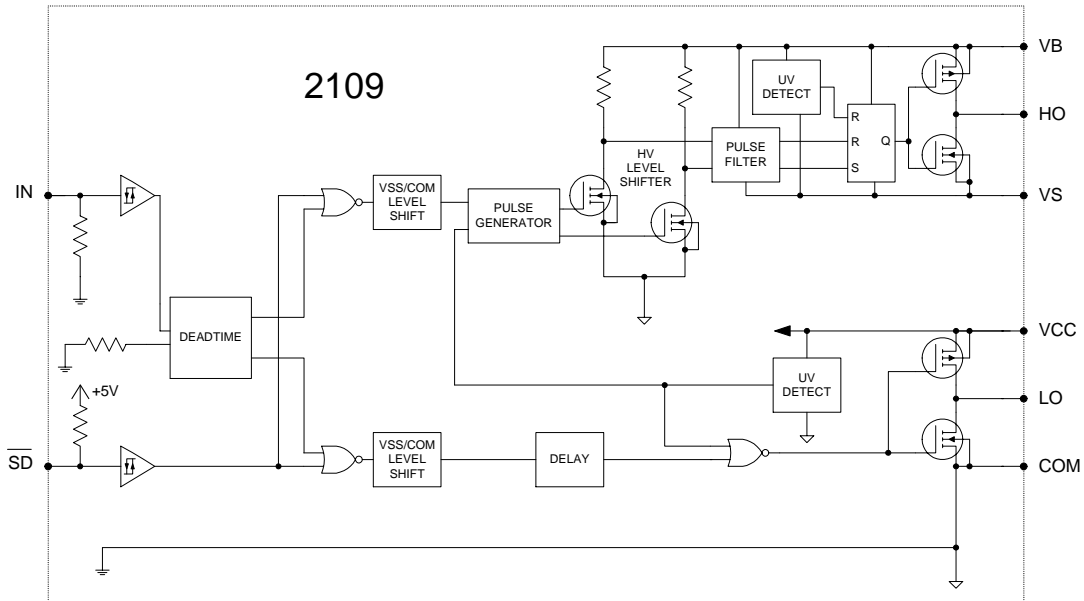

The IRS2109 and IR2109 share the same block diagram. The IRS21094 and IR21094 share the same block diagram. There are no functional changes between corresponding part numbers.

Electrical Characteristic Differences

All measurement conditions remain unchanged unless noted. Parameters not mentioned in this document have not changed.

Absolute Maximum Ratings

There are no changes in the Absolute Maximum Ratings.

Recommended Operating Conditions

There are no changes in the Recommended Operating Conditions.

Dynamic Electrical Characteristics

Parameter		IR210(9,94)		IRS210(9,94)		Units
Symbol	Definition	typ	max	typ	max	
t_r	Turn-on rise time ($V_s = 0$ V)	150	220	100	220	ns
t_f	Turn-off fall time ($V_s = 0$ V)	50	80	35	80	

The IRS210(9,94) has faster rise and fall times when compared to the IR210(9,94).

Static Electrical Characteristics

Parameter		IR210(9,94)			IRS210(9,94)			Units
Symbol	Definition	min	typ	max	min	typ	max	
V_{IH}	Logic "1" input voltage ($V_{CC} = 10$ V to 20 V)	2.9	-	-	2.5	-	-	V
V_{IL}	Logic "0" input voltage ($V_{CC} = 10$ V to 20 V)	-	-	0.8	-	-	0.8	
$V_{SD,TH+}$	SD input positive going threshold	2.9	-	-	2.5	-	-	
$V_{SD,TH-}$	SD input negative going threshold	-	-	0.8	-	-	0.8	
V_{OH}	High level output voltage, $V_{BIAS} - V_O$	-	0.8	1.4	-	0.05	0.2	
		I _o = 20 mA			I _o = 2 mA			
V_{OL}	Low level output voltage, V_O	-	0.3	0.6	-	0.02	0.1	
		I _o = 20 mA			I _o = 2 mA			
I_{O+}	Output high short circuit pulsed current ($V_O = 0$ V, $V_{IN} = \text{Logic "1"}$, $PW \leq 10$ us)	120	200	-	120	290	-	mA
I_{O-}	Output low short circuit pulsed current ($V_O = 15$ V, $V_{IN} = \text{Logic "0"}$, $PW \leq 10$ us)	250	350	-	250	600	-	

With the IRS210(9,94),

1. The V_{IH} and $V_{SD, TH+}$ are reduced to 2.5 V for better 3.3 V logic compatibility.
2. The V_{OH} and V_{OL} are tested using a new standardized test condition of I_o=2 mA. The output driver's on resistance is lower for IRS210(9,94), which improves immunity against the Miller effect.
3. The typical values for I_{O+} and I_{O-} are increased, which allows faster switching.

Figures

This figures shown in this section compare figures shown in the IR210(9,94) (left column) and IRS210(9,94) (right column) datasheets. Illustrations that have not changed between the two datasheets have not been included in this section.

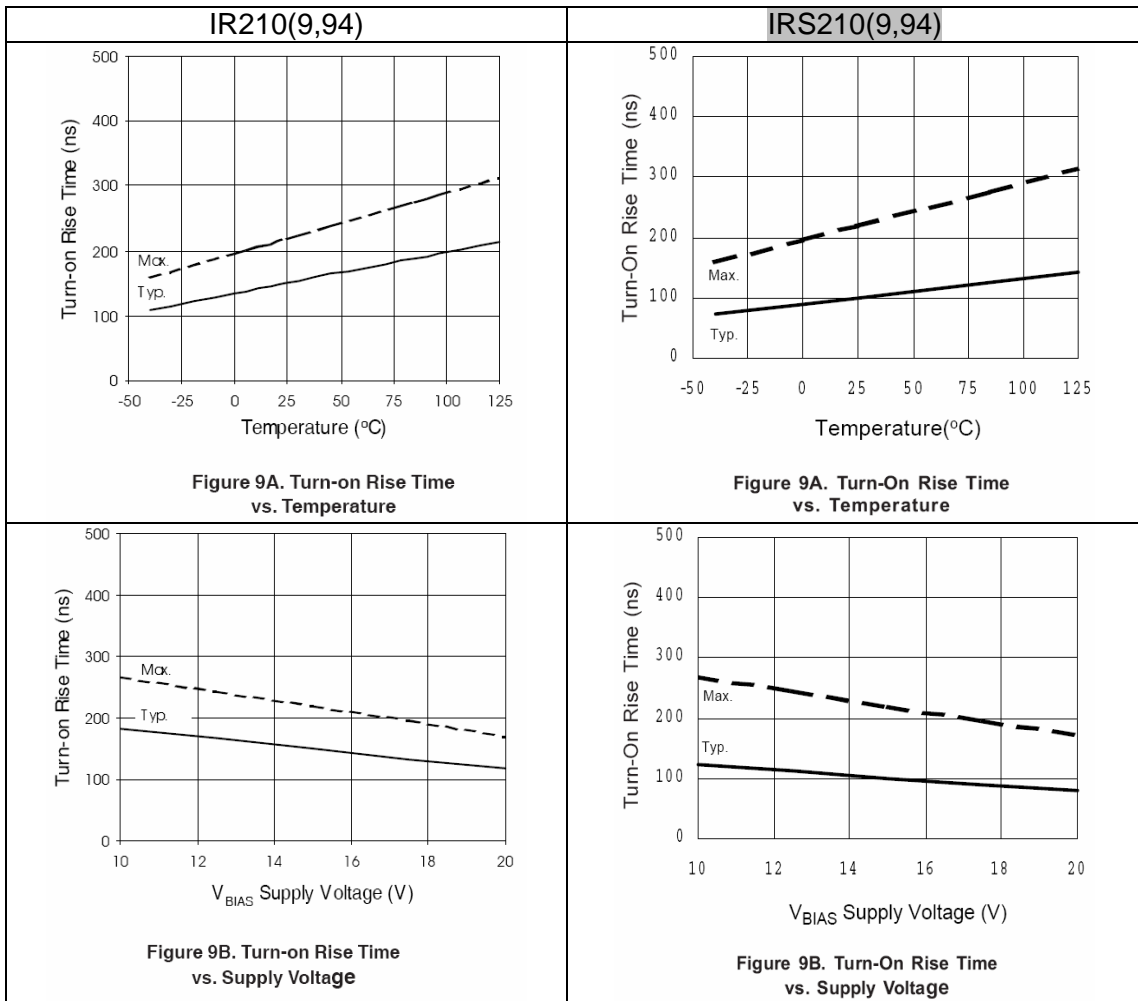

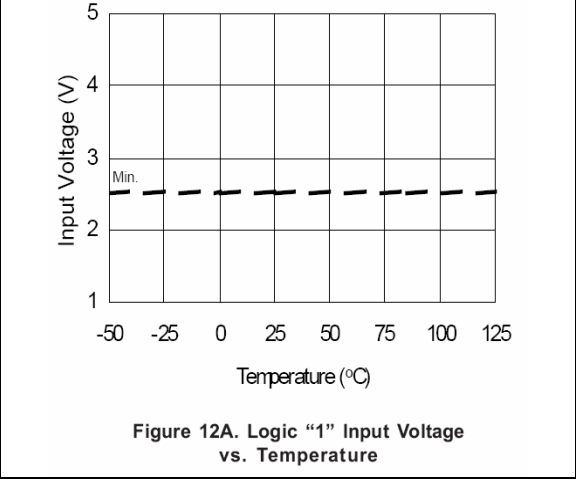
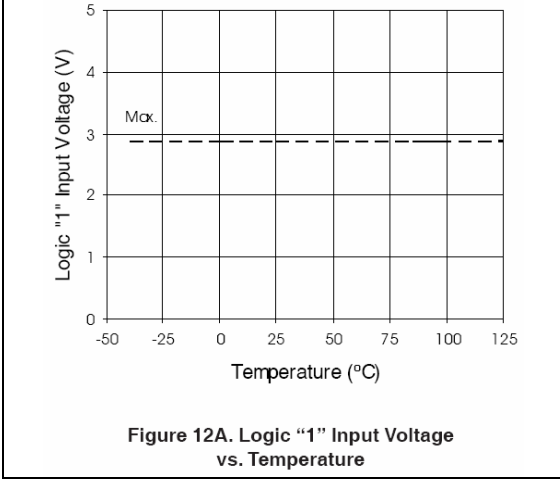
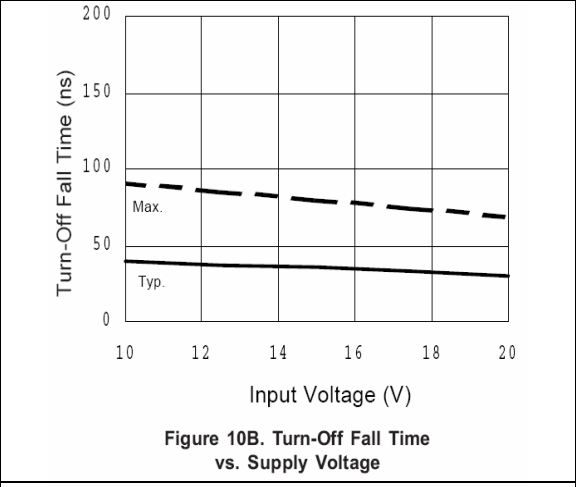
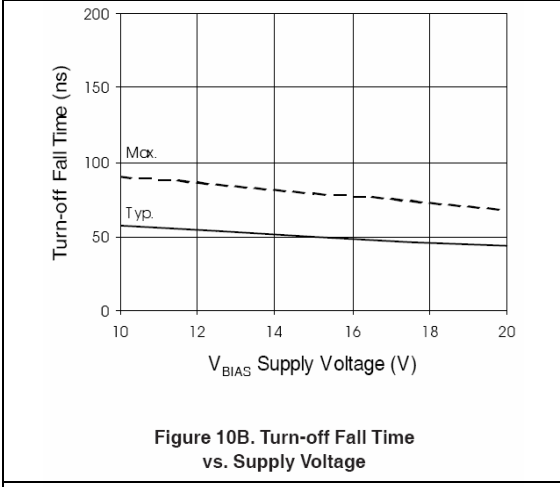
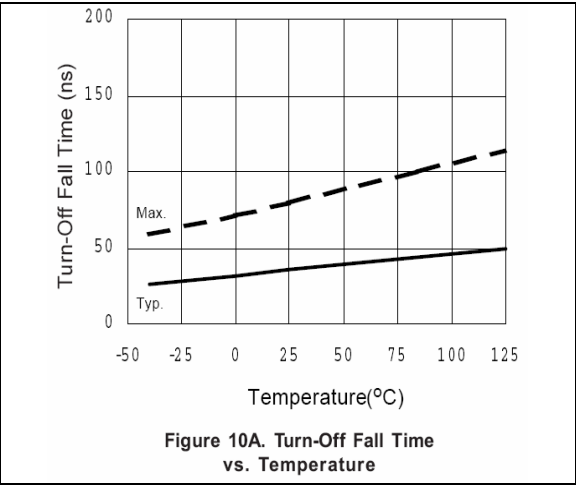
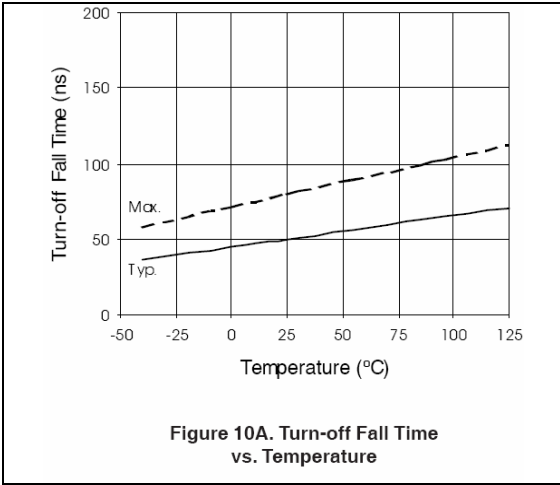

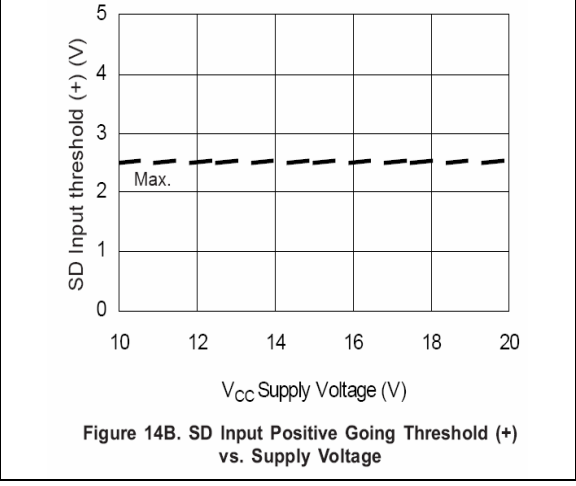
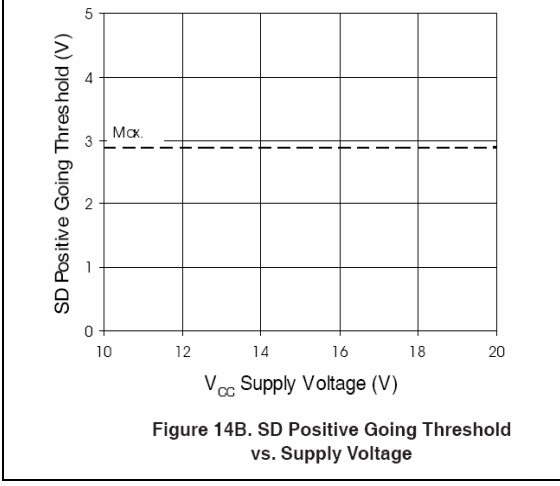
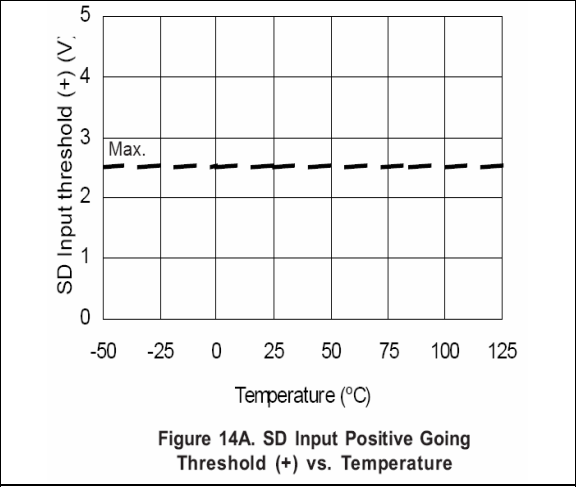
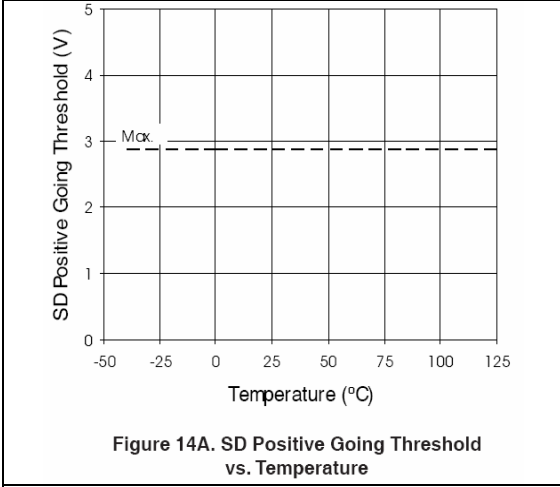
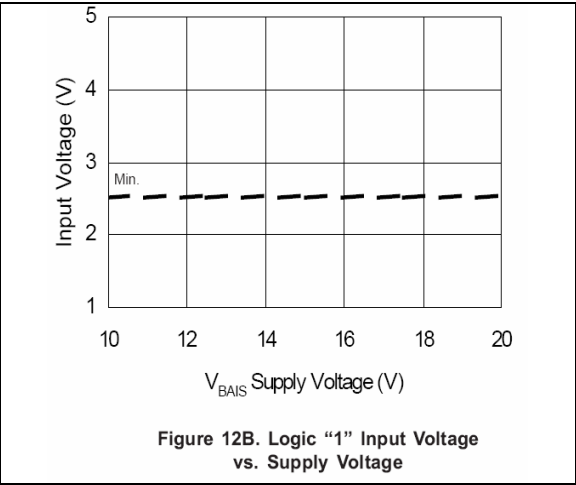
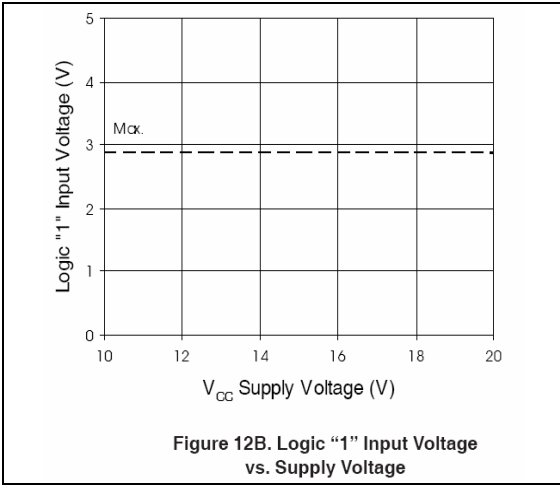

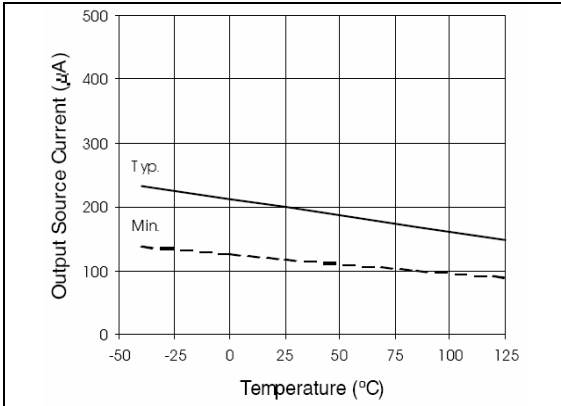

Figure 27A. Output Source Current vs. Temperature

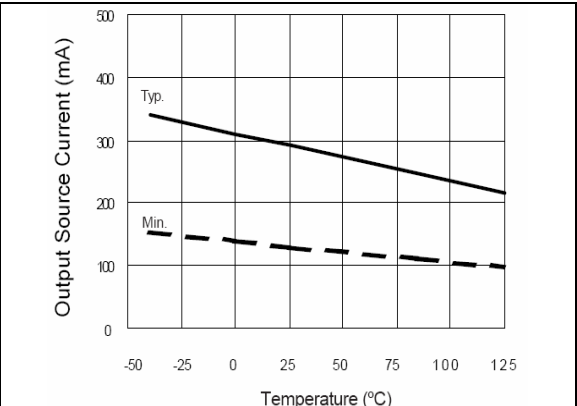

Figure 27A. Output Source Current vs. Temperature

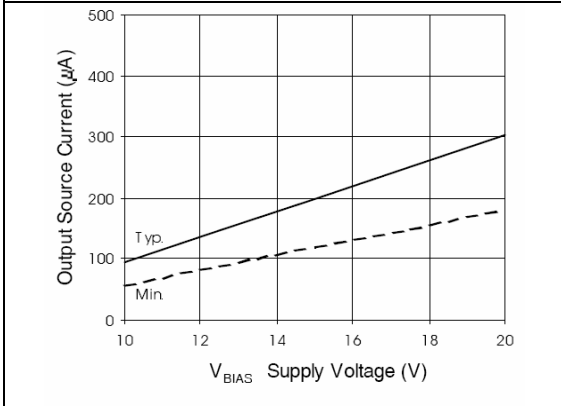

Figure 27B. Output Source Current vs. Supply Voltage

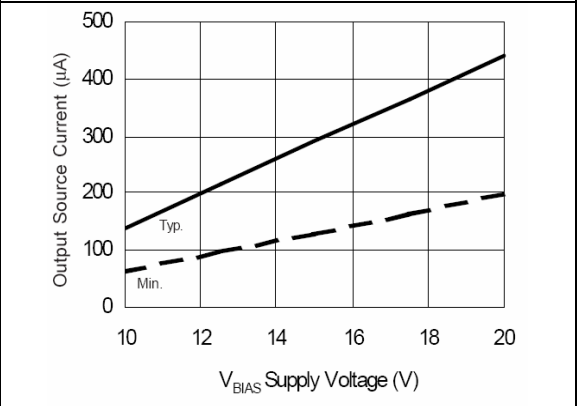

Figure 27B. Output Source Current vs. Supply Voltage

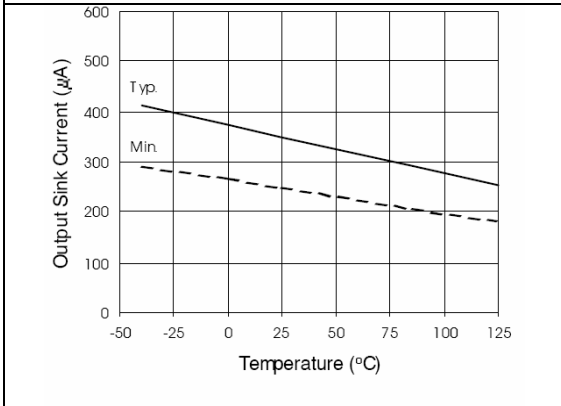

Figure 28A. Output Sink Current vs. Temperature

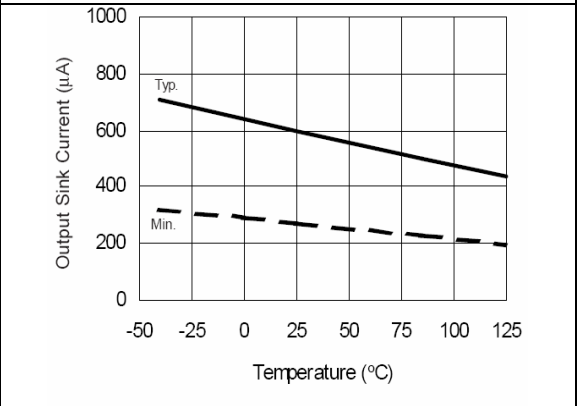
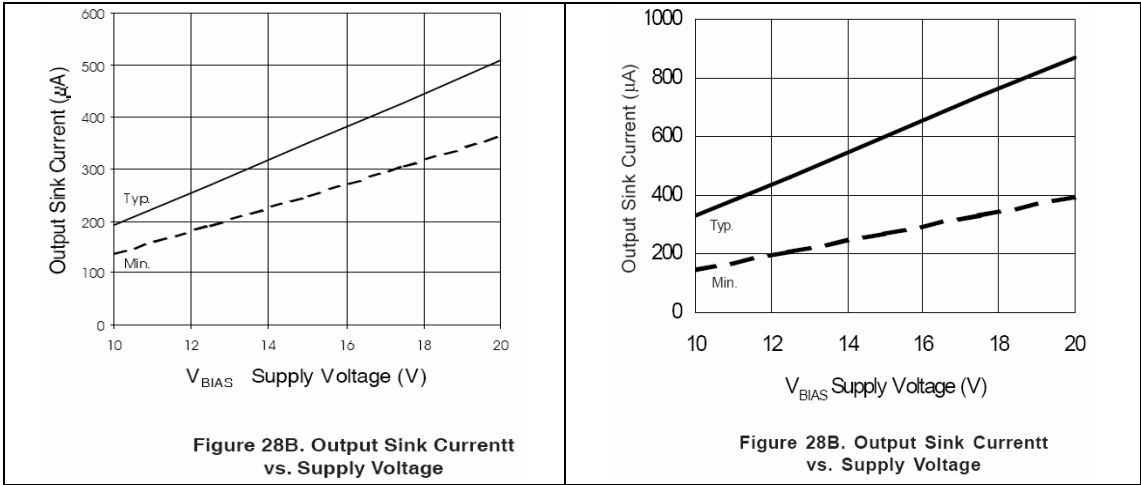

Figure 28A. Output Sink Current vs. Temperature



Summary

As shown by this document, the IRS210(9,94) and the IR210(9,94) are very similar with only a few negligible parametric differences.