

# Application Note AN-1100

## IRS211(0,3) and IR211(0,3) Comparison

*By Jason Nguyen, Min Fang, David New*

### Table of Contents

	<b>Page</b>
Introduction .....	1
Block Diagram.....	2
Electrical Characteristic Differences.....	2
Figures .....	3
Summary.....	7

### Introduction

The IRS211(0,3) are new HVIC products that replace the IR211(0,3) HVICs and are pin-to-pin compatible with their corresponding predecessor. In many cases, little or no change is necessary to use the new products. This application note describes the various differences between the next and previous generation.

The IR211(0,3) are high voltage, high speed power MOSFET and IGBT drivers with independent high and low side referenced output channels. Proprietary HVIC and latch immune CMOS technologies enable ruggedized monolithic construction. Logic inputs are compatible with standard CMOS or LSTTL outputs, down to 3.3 V logic. The output drivers feature a high pulse current buffer stage designed for minimum driver cross-conduction. Propagation delays are matched to simplify its use in high frequency applications. The floating channel can be used to drive an N-channel power MOSFET or IGBT in the high side configuration which operates up to 500 V or 600 V.

### Block Diagram

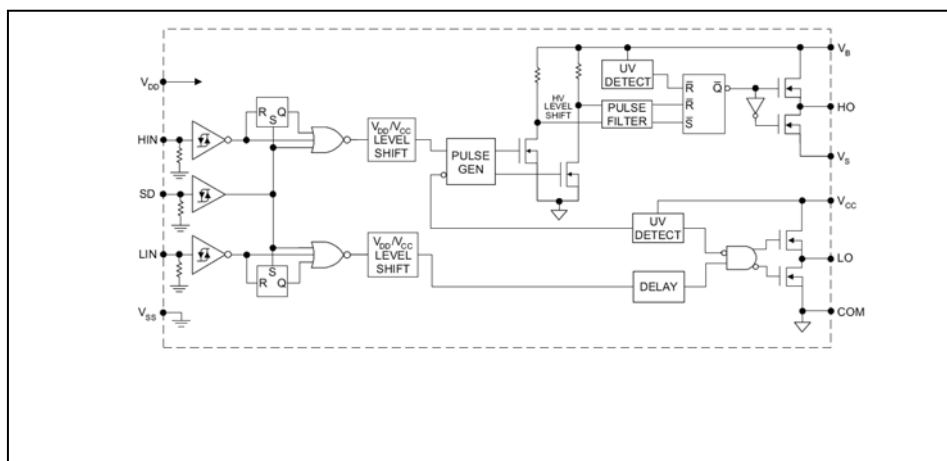

The IRS211(0,3) and the IR211(0,3) share the same block diagram. There are no functional changes between corresponding part numbers.

### Electrical Characteristic Differences

All measurement conditions remain unchanged unless noted. Parameters not mentioned in this document have not changed.

### Absolute Maximum Ratings

Parameter		IR2110/2113		IRS2110/2113		Units	
Symbol	Definition	min	max	min	max		
V <sub>B</sub>	High side floating supply voltage	(IR2110/IRS2110)	-0.3	525	-0.3	520 (Note1)	V
		(IR2113/IRS2113)	-0.3	625	-0.3	620 (Note1)	
V <sub>S</sub>	High side floating supply offset voltage	V <sub>B</sub> - 25	V <sub>B</sub> + 0.3	V <sub>B</sub> - 20	V <sub>B</sub> + 0.3		
V <sub>CC</sub>	Low side fixed supply voltage	-0.3	25	-0.3	20 (Note1)		
V <sub>DD</sub>	Logic supply voltage	-0.3	V <sub>SS</sub> + 25	-0.3	V <sub>SS</sub> - 20 (Note1)		
V <sub>SS</sub>	Logic supply offset voltage	V <sub>CC</sub> - 25	V <sub>CC</sub> + 0.3	V <sub>CC</sub> - 20	V <sub>CC</sub> + 0.3		

Note1: In IRS211(0,3), all supplies are fully tested at 25 V and an internal 20 V clamp exists for each supply. The 20 V, internal clamp improves the IC survivability against supply transient spikes but at the same time reduces the absolute maximum rating to 20 V.

For applications that require recovery from an output short-circuit to negative bus, do not allow V<sub>BS</sub> ≥ 25 V for more than 1 μs in such a short-circuit recovery event. To help ensure this parameter corresponds to the datasheet DC condition limit, consider:

1. decreasing the di/dt by increasing  $R_{g,OFF}$ ,
2. decreasing the  $V_S$  to COM distance on the PCB,
3. reducing the short-circuit current level,
4. adding  $R_B$  in series with  $C_B$ ,
5. or increasing the size of  $C_B$ .

## Recommended Operating Conditions

There are no changes in the Recommended Operating Conditions.

## Dynamic Electrical Characteristics

Parameter		IR2110/2113		IRS2110/2113		Units
Symbol	Definition	typ	max	typ	max	
$t_{on}$	Turn-on propagation delay ( $V_S = 0$ V)	120	150	130	160	ns
$t_{off}$	Turn-off propagation delay ( $V_S = 500$ V / 600 V)	94	125	120	150	
$t_{sd}$	Shutdown propagation delay ( $V_S = 500$ V / 600 V)	110	140	130	160	

There is a small difference in propagation delays between the IRS211(0,3) and the IR211(0,3).

## Static Electrical Characteristics

Parameter		IR2110/2113			IRS2110/2113			Units
Symbol	Definition	min	typ	max	min	typ	max	
$V_{OH}$	High level output voltage, $V_{BIAS} - V_O$	-	-	1.2 ( $I_O=0$ mA)	-	-	1.2 ( $I_O=0$ mA)	V
$V_{OL}$	Low level output voltage, $V_O$	-	-	0.1 ( $I_O=0$ mA)	-	-	0.15 ( $I_O=20$ mA)	

The  $V_{OL}$  is tested using a new standardized test condition of  $I_O=20$  mA.

## Figures

This figures shown in this section compare figures shown in the IR211(0,3) (left column) and IRS211(0,3) (right column) datasheets. Illustrations that have not changed between the two datasheets have not been included in this section.

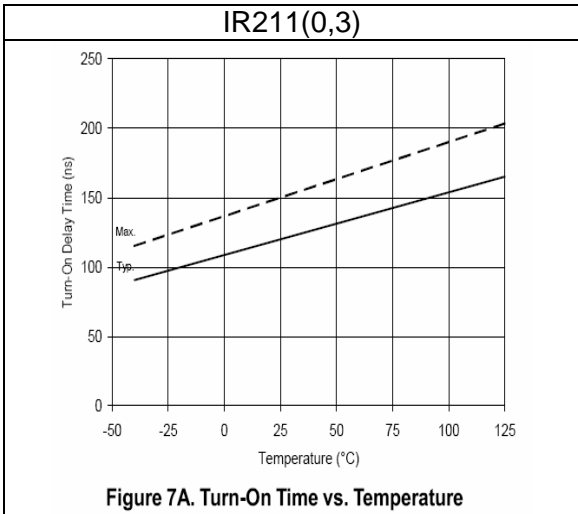

Figure 7A. Turn-On Time vs. Temperature

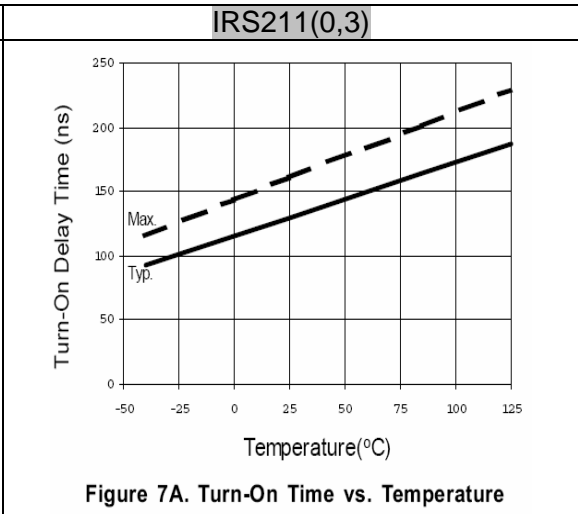

Figure 7A. Turn-On Time vs. Temperature

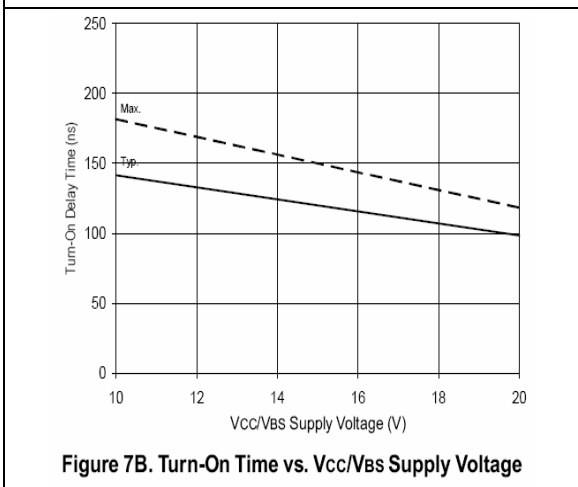

Figure 7B. Turn-On Time vs. Vcc/Vbs Supply Voltage

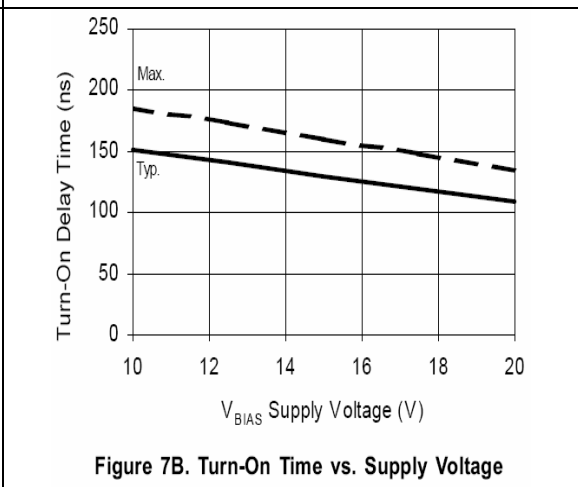

Figure 7B. Turn-On Time vs. Supply Voltage

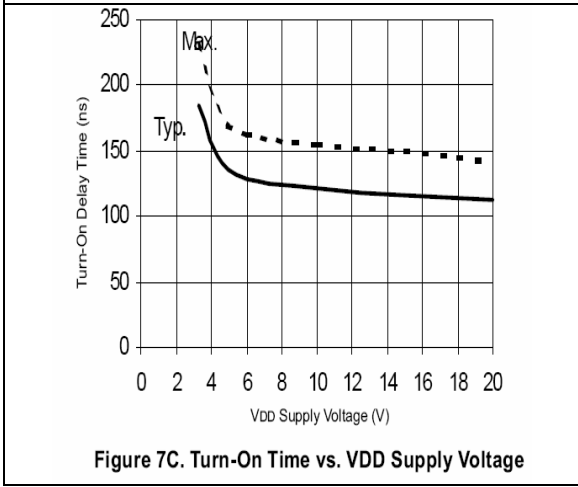

Figure 7C. Turn-On Time vs. V<sub>DD</sub> Supply Voltage

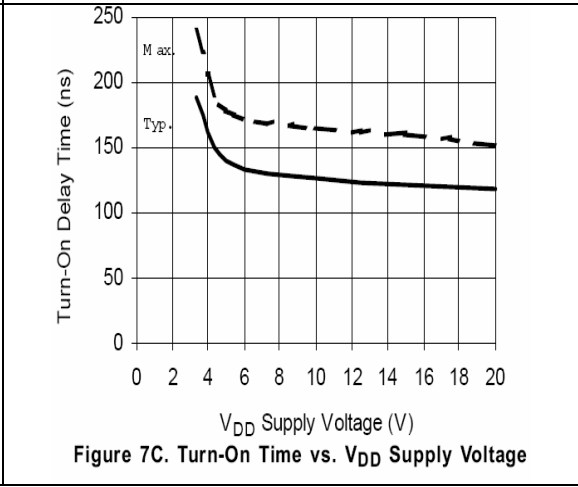

Figure 7C. Turn-On Time vs. V<sub>DD</sub> Supply Voltage

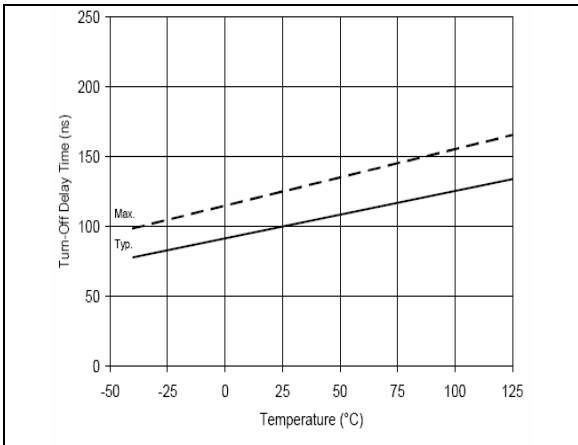

Figure 8A. Turn-Off Time vs. Temperature

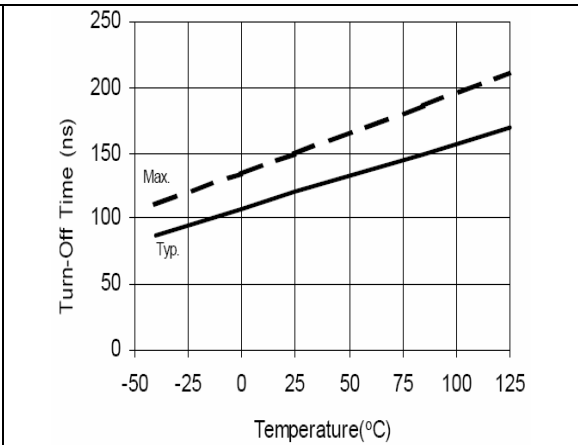

Figure 8A. Turn-Off Time vs. Temperature

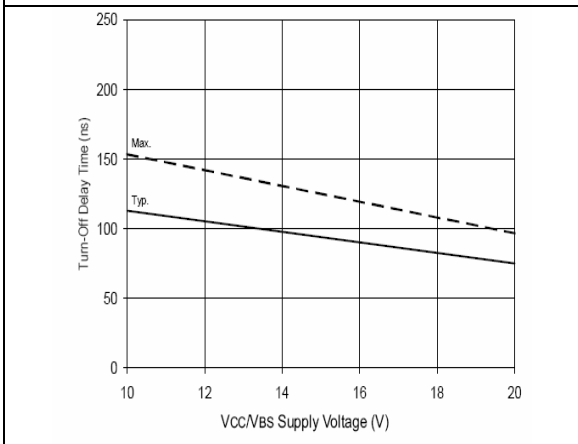

Figure 8B. Turn-Off Time vs. Vcc/Vs Supply Voltage

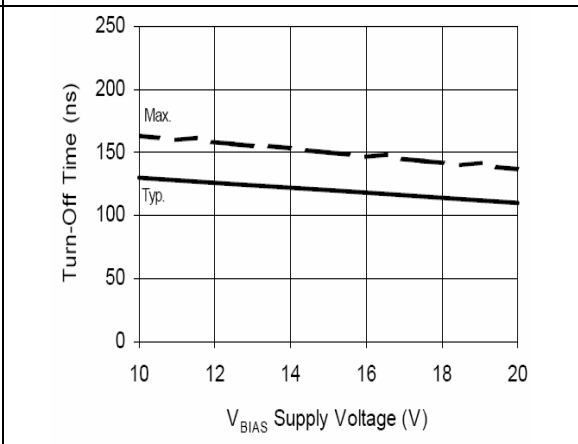

Figure 8B. Turn-Off Time vs. Supply Voltage

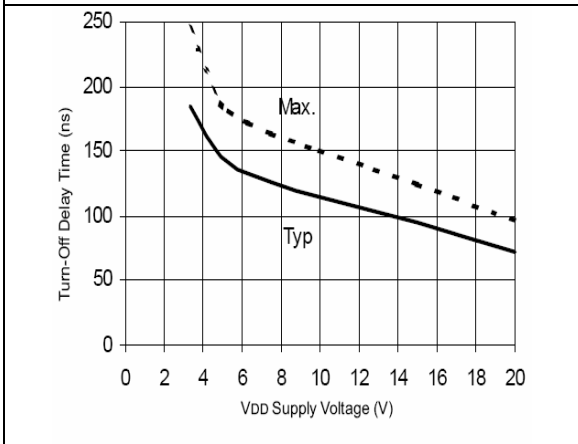

Figure 8C. Turn-Off Time vs. VDD Supply Voltage

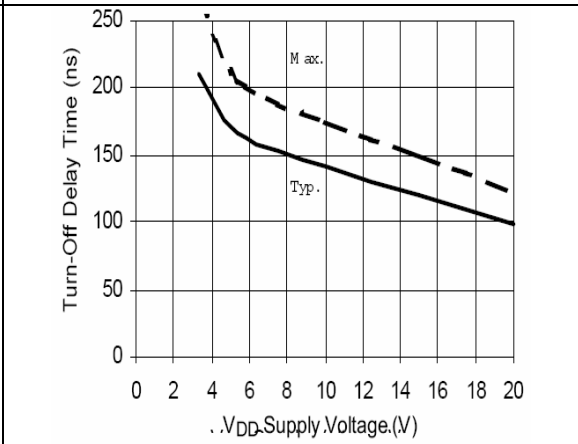
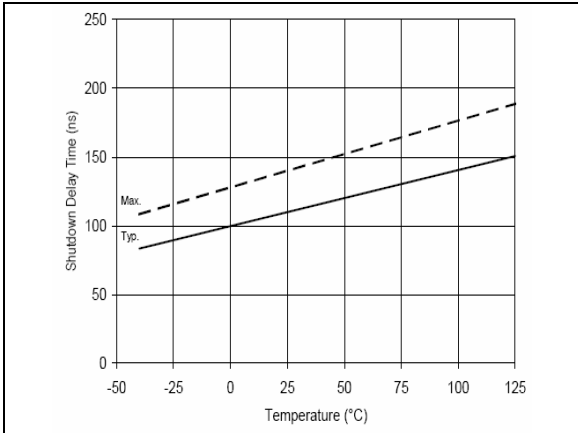
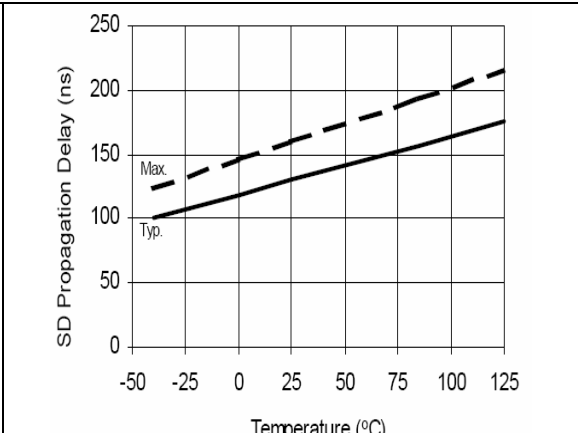

Figure 8C. Turn-Off Time vs. VDD Supply Voltage



**Figure 9A. Shutdown Time vs. Temperature**



**Figure 9A. Shutdown Time vs. Temperature**

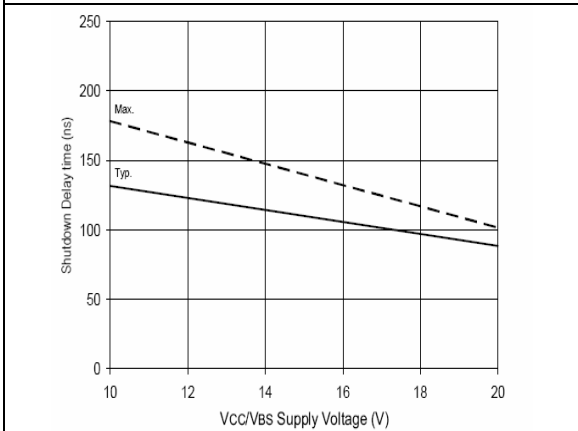

**Figure 9B. Shutdown Time vs. Vcc/Vbs Supply Voltage**

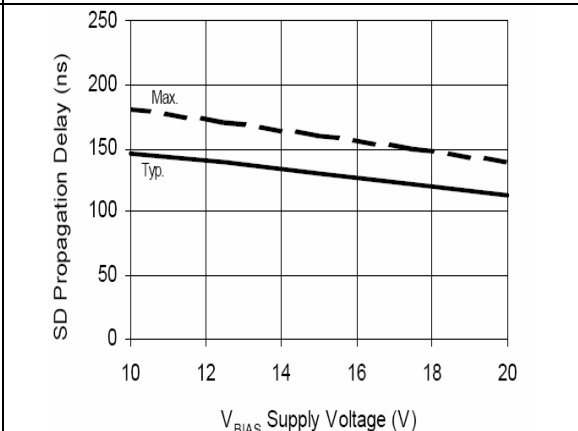

**Figure 9B. Shutdown Time vs. Supply Voltage**

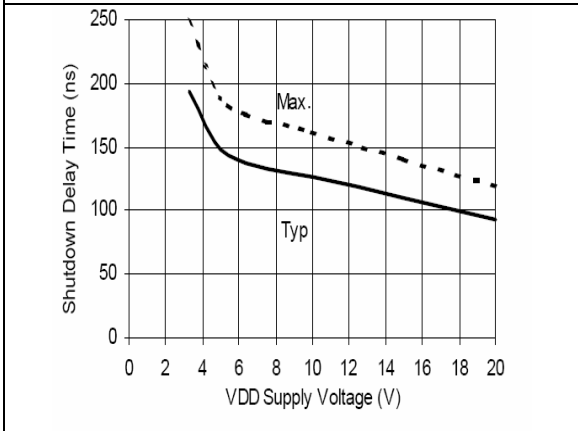

**Figure 9C. Shutdown Time vs. V<sub>DD</sub> Supply Voltage**

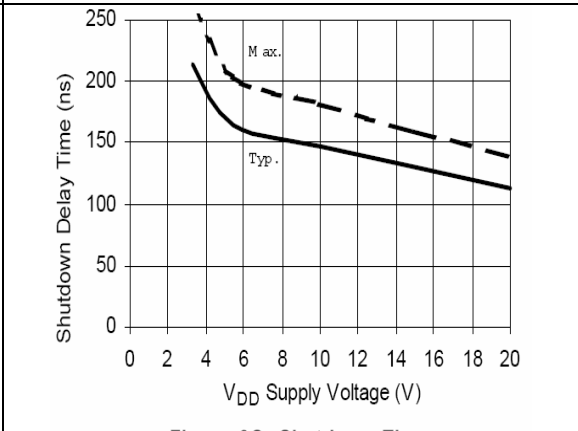

**Figure 9C. Shutdown Time vs. V<sub>DD</sub> Supply Voltage**

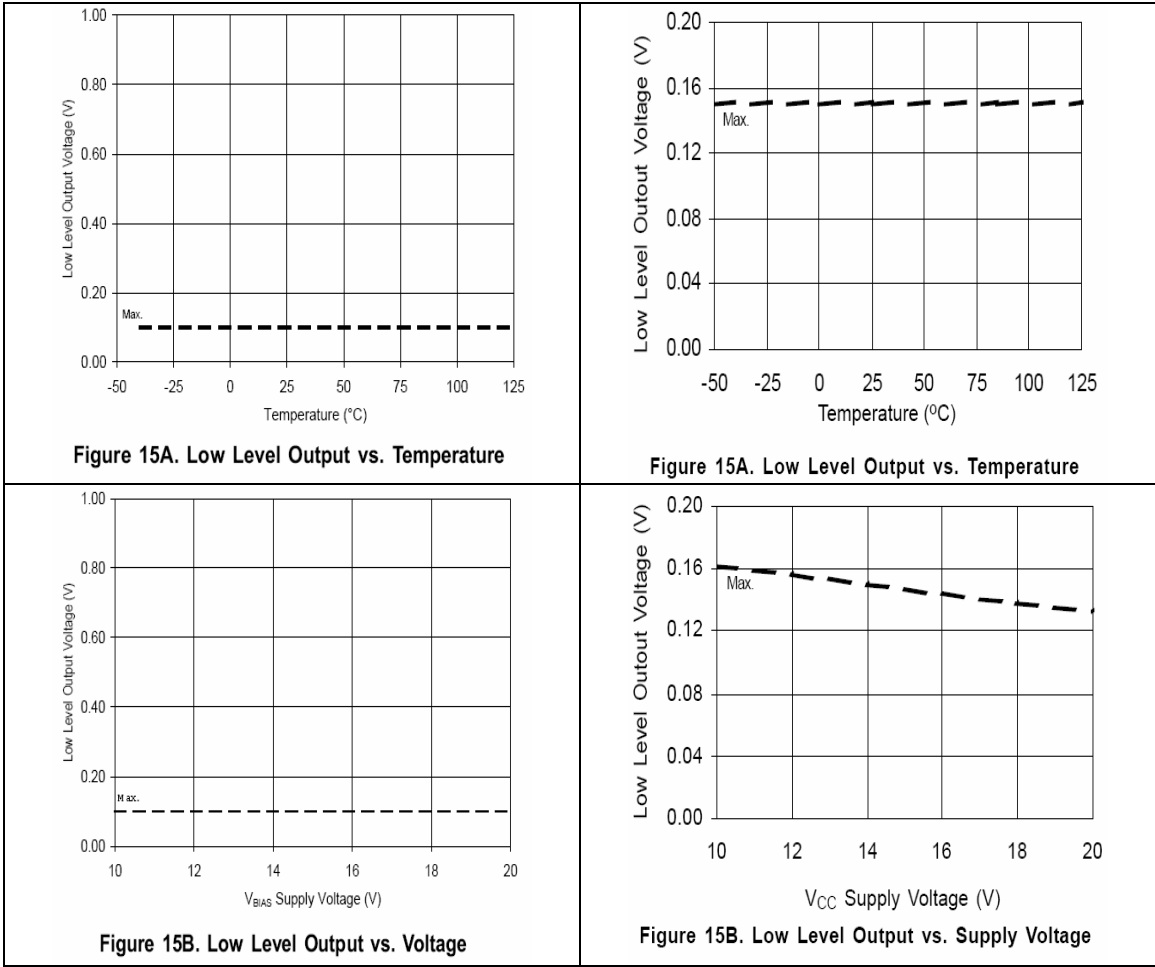

## Summary

As shown by this document, the IRS211(0,3) and the IR211(0,3) are very similar with only a few negligible parametric differences.