

## Package Outline

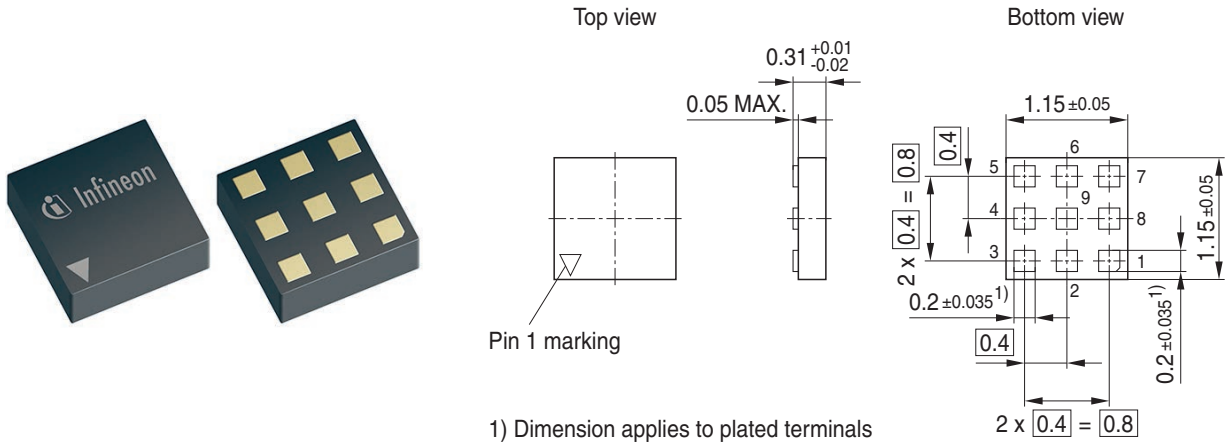

## Foot Print

Soldering Type: Reflow Soldering

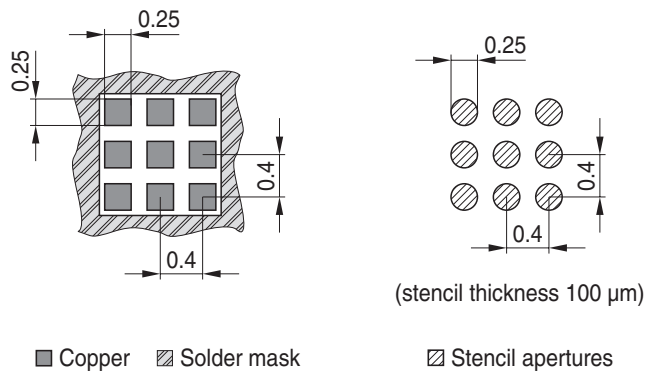

## Marking Layout

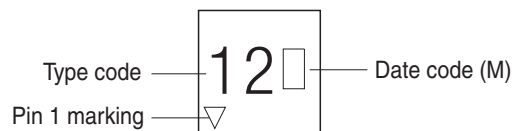

## Tape and Reel

Reel ø180 mm: 7.500 Pieces/Reel  
Reels/Box: 1

