

First Quarter FY2009

Quarterly Update

Infineon Technologies
Investor Relations



Never stop thinking

Disclaimer

This presentation was prepared as of February 6, 2009 and is current only as of that date.

This presentation includes forward-looking statements about the future of Infineon's business and the industry in which we operate. These include statements relating to general economic conditions, future developments in the world semiconductor market (including the market for memory products), our ability to manage our costs and to achieve our savings and growth targets, the resolution of Qimonda's insolvency proceedings and the liabilities we may face as a result of Qimonda's insolvency, the benefits of research and development alliances and activities, our planned levels of future investment, the introduction of new technology at our facilities, the continuing transitioning of our production processes to smaller structure sizes, and our continuing ability to offer commercially viable products. These forward-looking statements are subject to a number of uncertainties, including broader economic developments, trends in demand and prices for semiconductors generally and for our products in particular, the success of our development efforts, both alone and with partners, the success of our efforts to introduce new production processes at our facilities, the actions of competitors, the availability of funds, the outcome of antitrust investigations and litigation matters, and actions by Qimonda and its creditors and other interested parties, as well as the other factors mentioned in this presentation and those described in the "Risk Factors" section of the annual report of Infineon on Form 20-F filed with the U.S. Securities and Exchange Commission on December 29th, 2008. As a result, Infineon's actual results could differ materially from those contained in these forward-looking statements. You are cautioned not to place undue reliance on these forward-looking statements.

Infineon does not undertake any obligation to publicly update or revise any forward-looking statements in light of developments which differ from those anticipated.

→ Infineon Results and Outlook

→ Qimonda Update

→ Business Highlights

Q1 FY09 Revenue EUR 830m, Segment Result EUR -102m

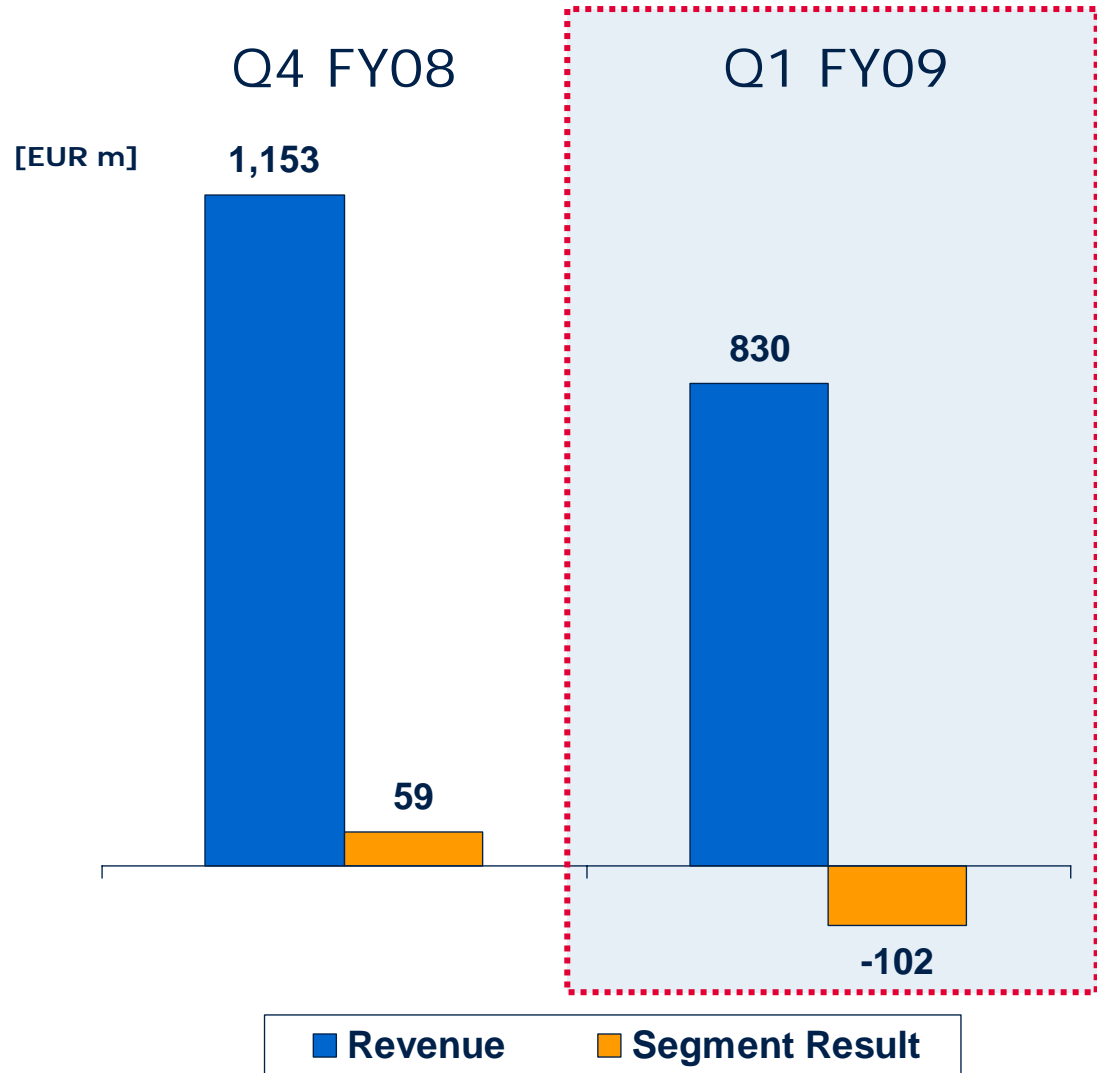
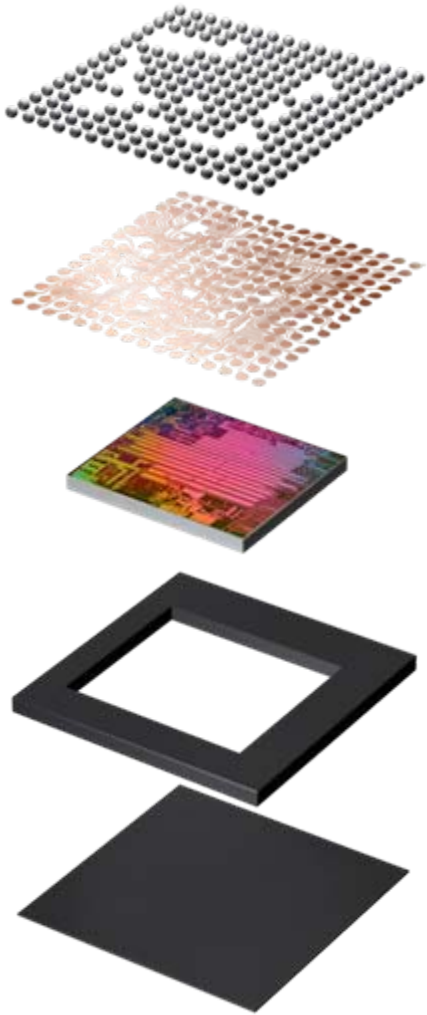

Q1 FY09 Revenue and Segment Result per Segment

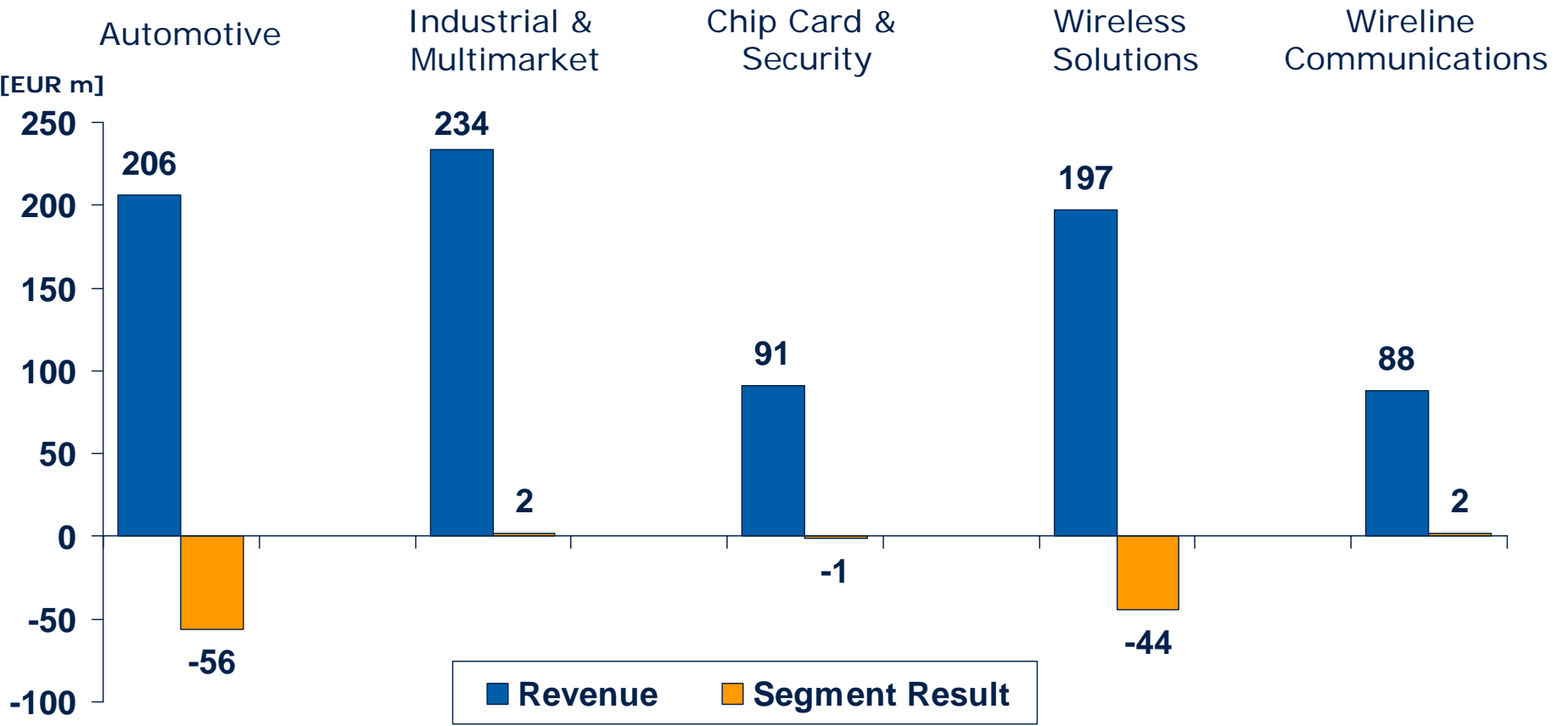

Focus Areas and Target Markets

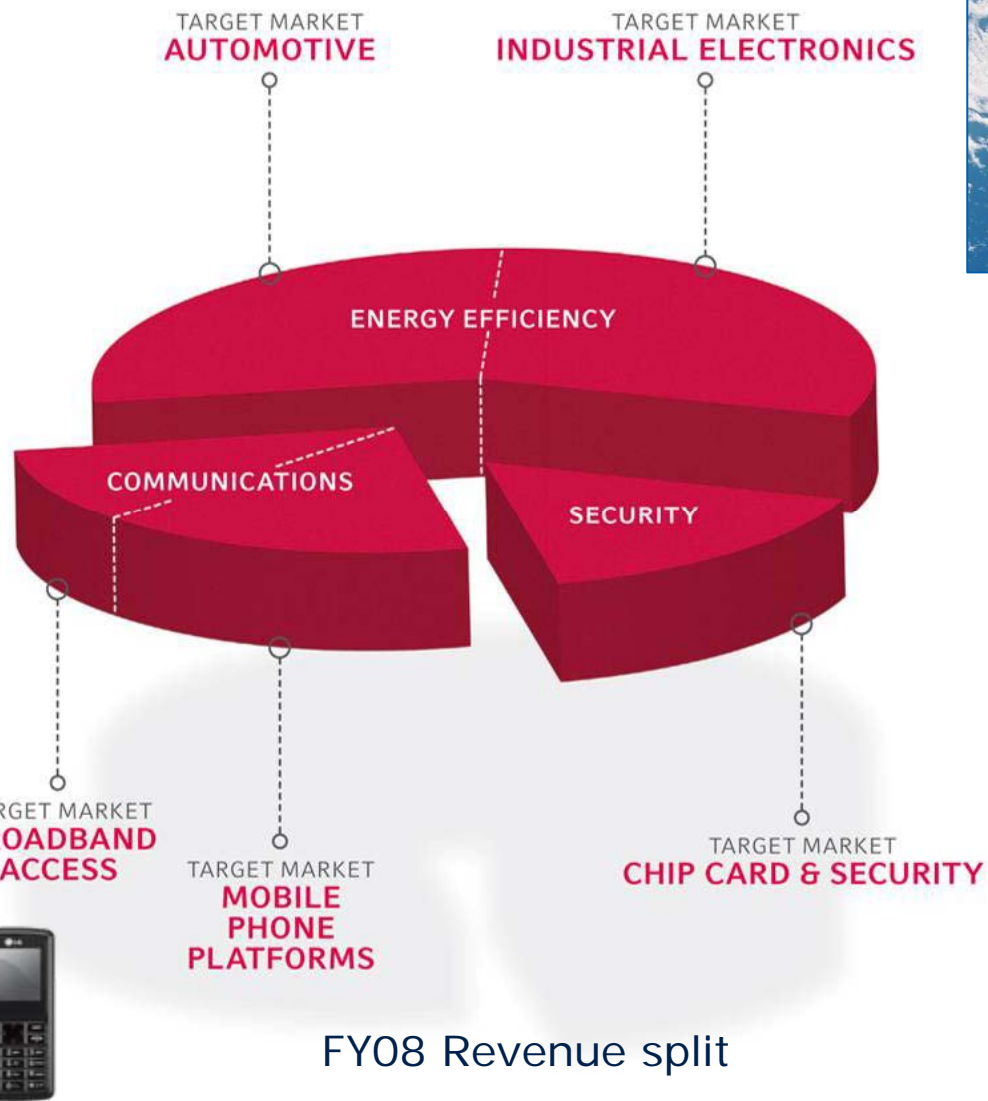

FY08 Revenue split

Organic Growth of Infineon on Constant Currency Basis



Growth Rate

- excluding acquisitions, divestitures
- calculated on constant Q1 FY09 FX rates

	y-o-y	q-o-q
Infineon Technologies	-26%	-32%
Automotive	-36%	-36%
Industrial & Multimarket	-16%	-30%
Chip Card & Security	-27%	-27%
Wireless Solutions	-27%	-37%
Wireline Communications	-20%	-22%

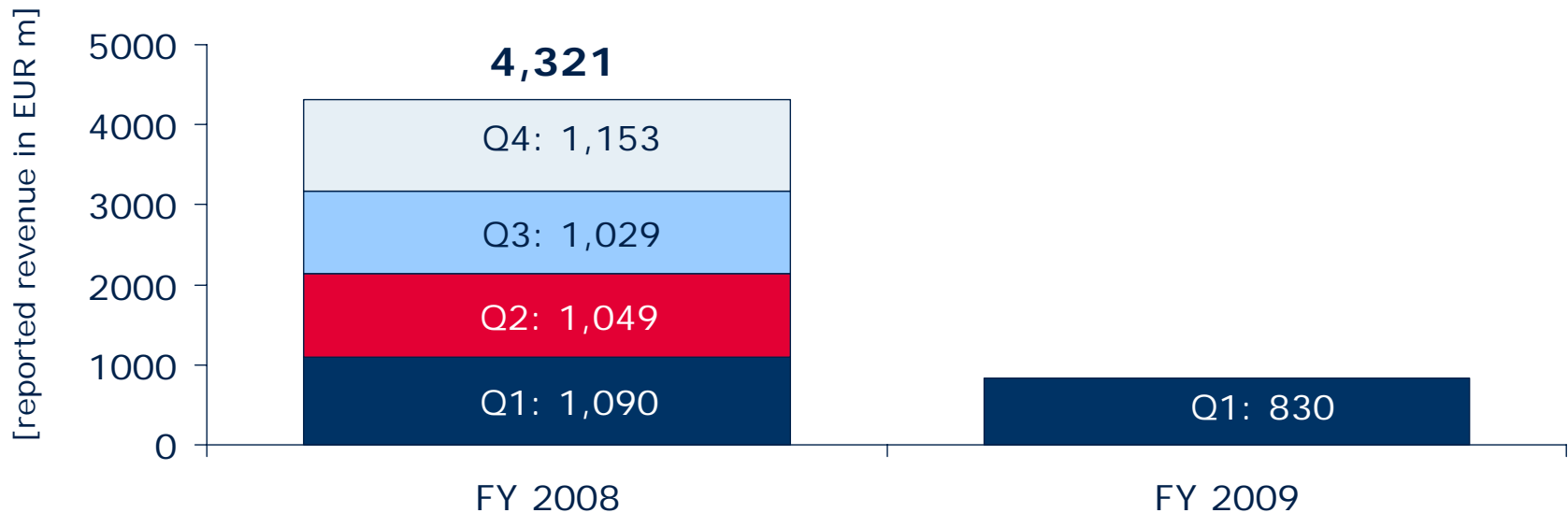

Managing Cash: Working Capital, D&A and CapEx (IFRS)



Working Capital

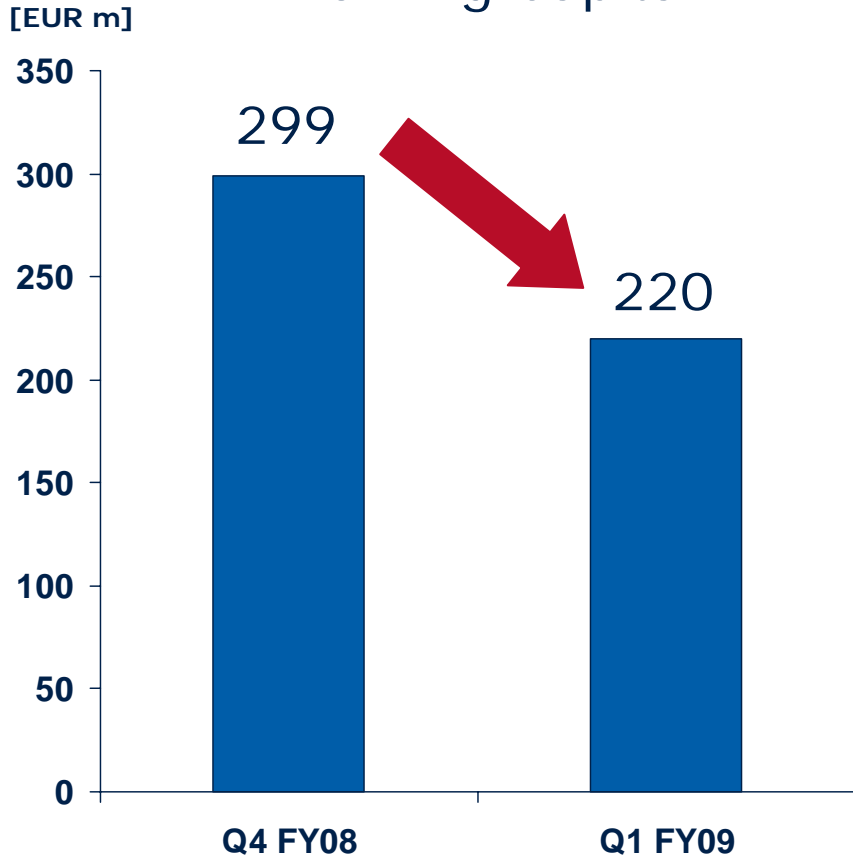

= (Current Assets - Cash - Available for sale financial assets) - (Current liabilities - short term debt)

D&A and CapEx*

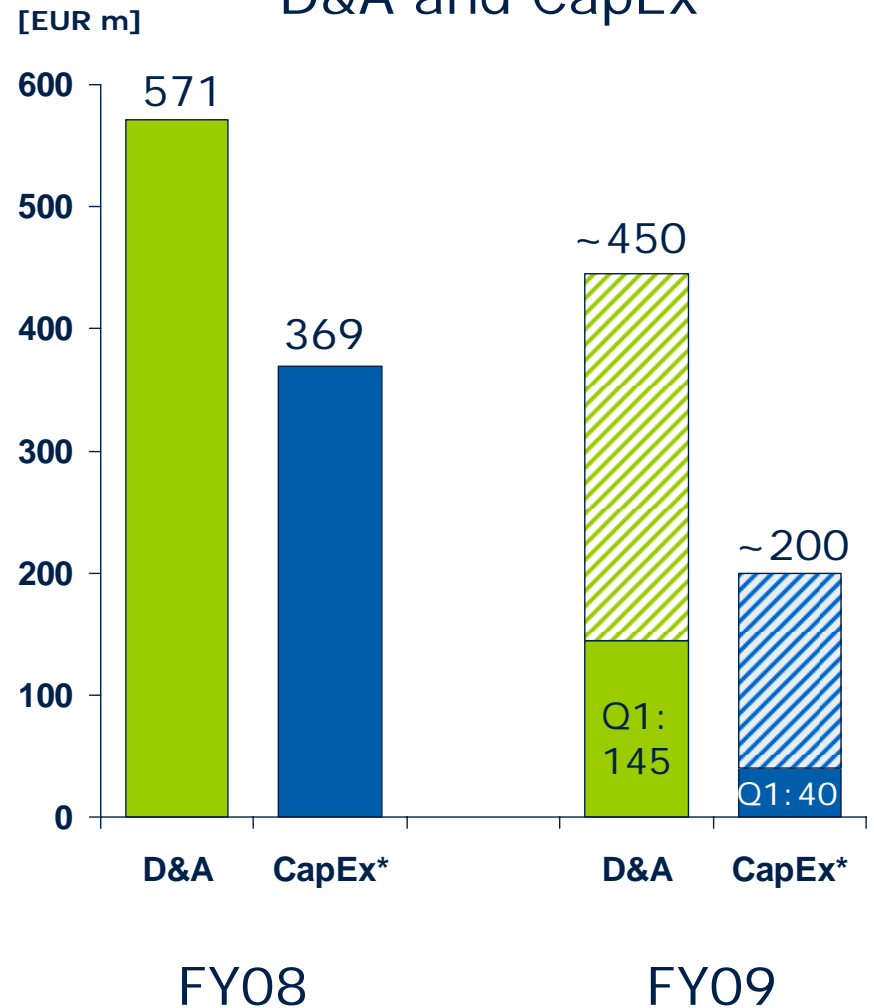

* CapEx including capitalized R&D and intangibles

Gross Cash, Gross Debt and Net Debt

[EUR m]

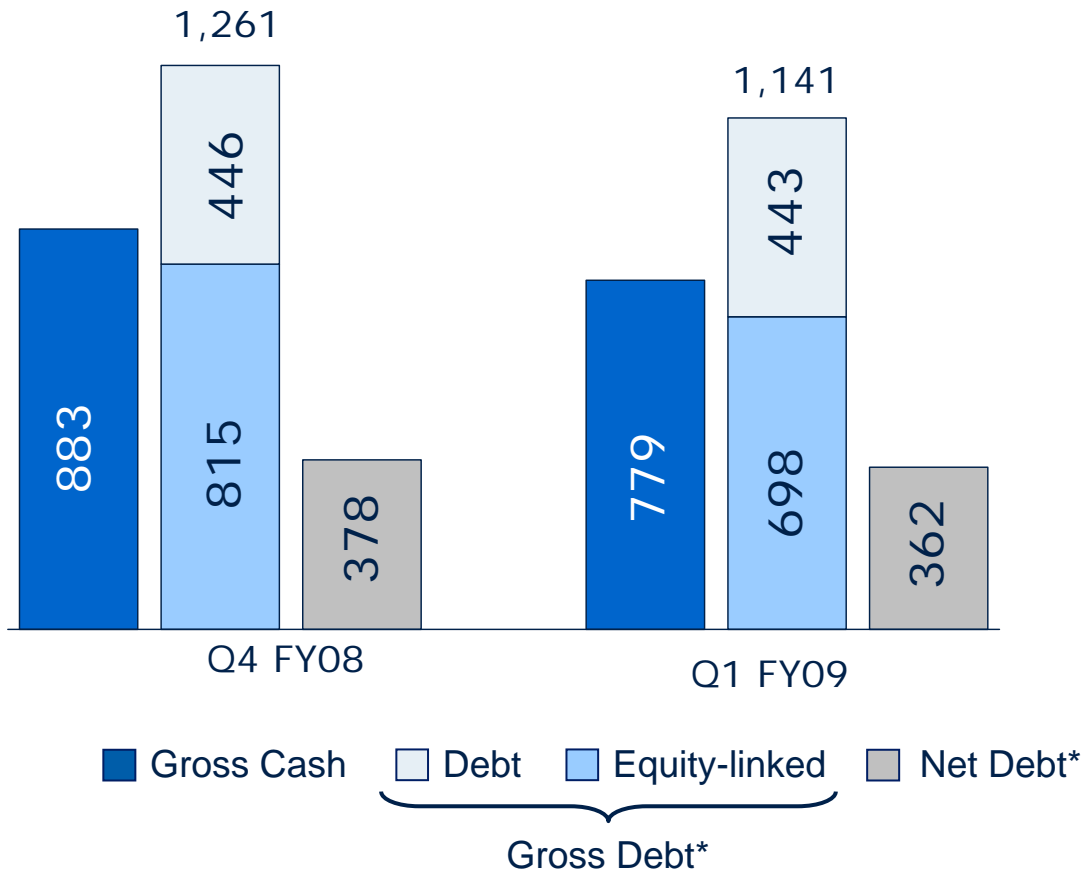

*all figures are nominal values

Debt Repurchase:

In the December quarter 2008, Infineon repurchased nominal amounts of EUR 95m of its exchangeable and EUR 22m of its convertible bonds.

Net debt, using nominal debt value, decreased slightly from the previous quarter despite the severe revenue and earnings drop.

Second Quarter FY 2009 Outlook (IFRS)

Revenues

IFX expects revenues in the second quarter to decrease by approximately 10 percent compared to the first quarter. After the significant decrease in demand in the Automotive and Wireless Solutions segments in the first quarter, the company expects these segments to be more resilient in the second quarter compared to the first quarter. By contrast, the three other segments, Industrial & Multimarket, Chip Card & Security and Wireline Communications, are expected to be more severely affected by the continuing slow-down in the second quarter.

Segment Result

Additional savings measures implemented under the IFX10+ program are expected to result in substantial additional cost and cash savings. As a consequence of continued sales declines and an aggressive reduction in factory loading in order to reduce inventory, Infineon expects combined Segment Result margin in the second quarter to be within the range of a negative mid-to-high teens percentage.

IFX10+ Savings

Implemented savings in Q1 FY09

- Cost savings of EUR 45m in the OpEx vs. Q4FY08
- Approx. 85% of the announced headcount reduction achieved
- EUR 25m cash outflow for IFX10+ in Q1 FY09
- Exit of employers' union

Additional Savings Measures:

- Reduced work hours in production sites Regensburg and Dresden
- Change in bonus scheme for 2009 fiscal year
- New and very stringent travel policy
- CapEx reduction from EUR 300m to EUR 200m for FY09

→ Infineon Results and Outlook

→ Qimonda Update

→ Business Highlights

Qimonda

- Infineon may be exposed to a number of significant liabilities relating to the Qimonda business, including pending antitrust and securities law claims, potential claims for repayment of governmental subsidies received, and employee-related contingencies.



- IFX increased provisions and allowances by Euro 195 million.
- Unrecognized currency translation effects of EUR 100m in Q2 FY08.
- Deconsolidation of Qimonda in Q2 FY09.

The recognition of such accumulated losses will not have any impact on Infineon's shareholders' equity.

→ Infineon Results and Outlook

→ Qimonda Update

→ Business Highlights

Automotive Segment Outstanding Quality and Satisfied Customers



NovalithIC™



High-current
motor drives
for automotive
applications

Seat Control Application

Door Module Application

Engine Application

Seatbelt Application

Infineon gained another significant design win with a major European Tier 1 for the **32bit TriCore microcontroller** family. The ECUs with Infineon microcontroller for engine and gearbox management will ramp in 2012.



Industrial & Multimarket Segment

Reducing Losses in the Whole Energy Chain



LTT: Light-triggered Thyristor



IGBT Modules (up to 6500V)

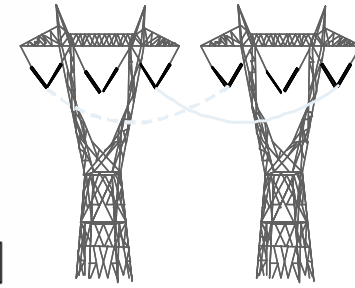
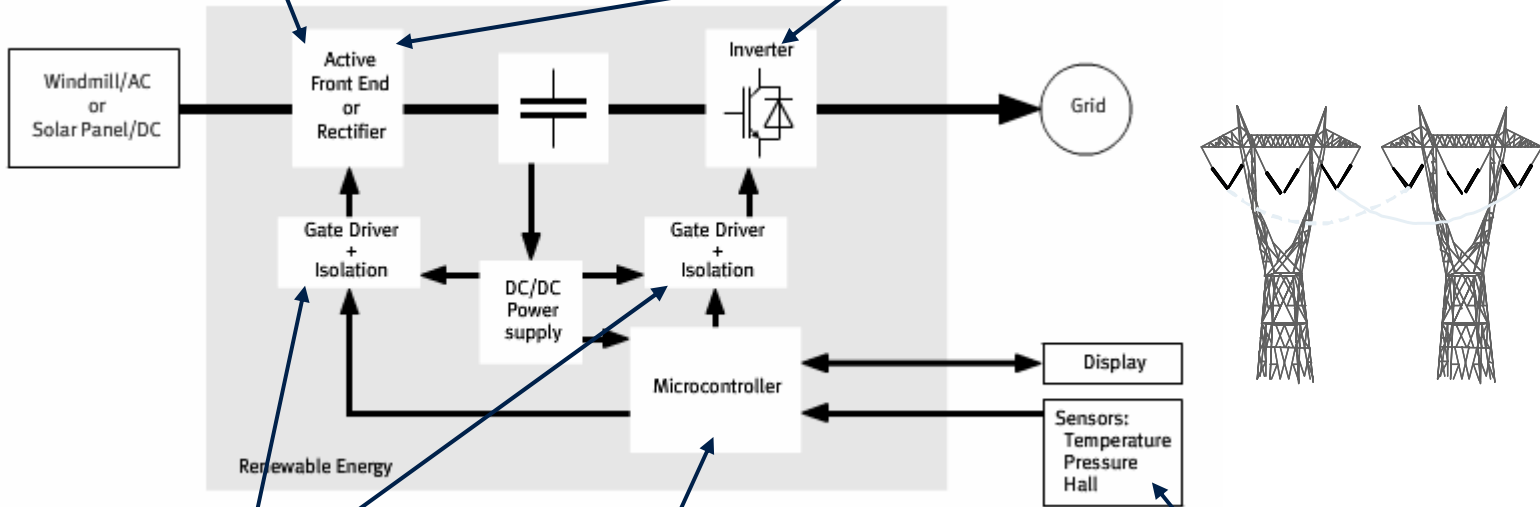

EiceDRIVER™



Industrial Microcontroller (8/16/32bit)



Sensors

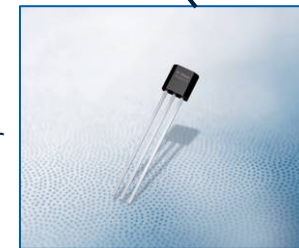

Chip Card & Security Segment Supplier to Major National Projects



(Extract)



Infineon has implemented projects in more than 60 countries.

Wireless Solutions Segment

Next Generation Ultra-Low-Cost Single Chip



X-GOLD™ 110

- third Generation Single Chip
- Ultra-Low-Cost segment (GSM)
- Baseband + RF Trans. + Power Mgmt
- 65nm technology
- MP3 and FM radio
- Samples available Q2 CY09

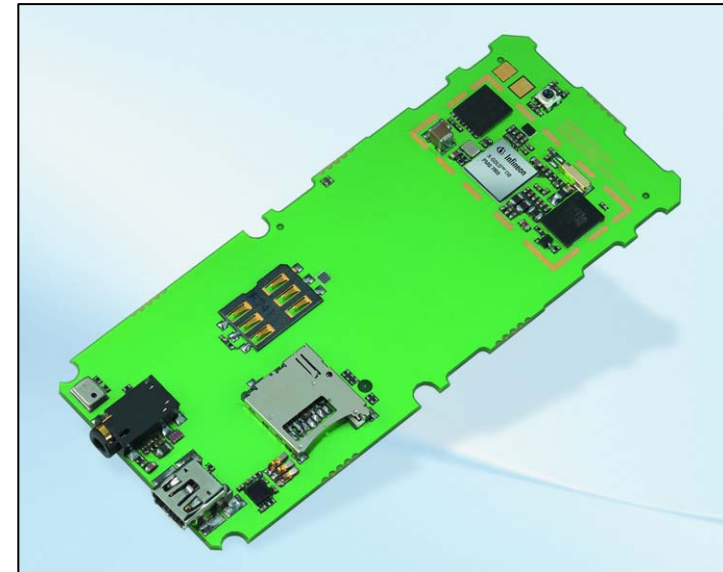

Wireless Solutions Segment Leading RF Technology



LTE Mobile Data



- World's most advanced LTE multimode trans.
- LTE / 3G / 2G single chip RF CMOS trans.
- up to 150 Mbps downlink
- DigRF v4 interface
- 65nm standard CMOS technology

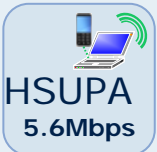
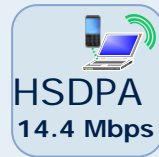

3G Low Cost



- 3G / 2G single chip transceiver
- low cost 3G market (China and India)
- DigRF v3.09 interface
- eliminating LNA and Rx filters
- enabling lowest BOM for 3G RF subsystems
- 130nm standard CMOS technology



Wireline Communications Segment

Leading Single-Chip ADSL Gateway Solution



XWAY™ ARX168:

- ✓ ADSL2+
downstream up to 25Mbit/s
upstream up to 1Mbit/s
- ✓ Gigabit Ethernet LAN
- ✓ 2x USB2.0
- ✓ Concurrent WLAN 11b/g/n



Highlights:

- True single-chip ADSL2+ solution with smallest footprint in the market (17 x 17 mm²)
- High performance 32-bit smart CPU architecture
- Support for high WLAN 802.11n throughput of more than 150Mbit/s
- Advanced IPTV features for highest quality of experience
- Support of EU Code of Conduct on Energy Consumption of Broadband Equipment

Operations

Fast Reaction to Drastic Volume Reduction



- The current focus is on idle cost management to conserve cash. Volume decrease is even higher than revenue decrease due to stock netting.

Fab Management

- Temporary fab shut down (Christmas, Chinese new year etc.)
- Insourcing of volume from Silicon foundry and Subcontractors
- Reduction of productive equipment, consecutive reduction of maintenance, electricity and material consumption
- Further invest reduction

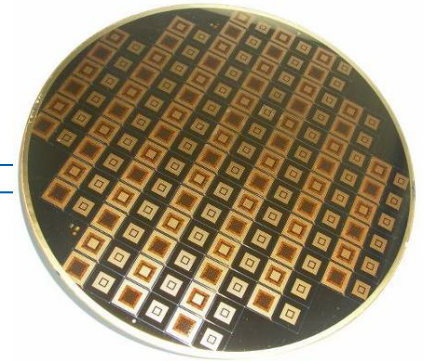

Labor Cost Management

- Reduction of temporary workers
- Short time working, unpaid leave
- Reduction of shifts, reduction of overtime and vacation
- Further Headcount reduction

A person wearing a white lab coat, a white face mask, and safety glasses is working in a laboratory. They are holding a piece of equipment, possibly a pipette or a small container, and are looking towards the camera. The background is a blurred laboratory setting with various pieces of equipment and shelves.

We commit.
We innovate.
We partner.
We create value.



Never stop thinking

Infineon Condensed Consolidated Statements of Operations (IFRS)



in Euro million	3 months ended		
	Dec 31, 07	Sep 30, 08	Dec 31, 08
Revenue	1,090	1,153	830
Cost of goods sold	(705)	(780)	(678)
Gross profit	385	373	152
Research and development expenses	(181)	(174)	(149)
Selling, general and administrative expenses	(136)	(150)	(112)
Other operating income	33	17	3
Other operating expense	(19)	(315)	(11)
Operating income (loss)	82	(249)	(117)
Financial income	18	21	60
Financial expense	(40)	(57)	(56)
Income from investments accounted for using the equity method, net	-	1	1
Income (loss) from continuing operations before income taxes	60	(284)	(112)
Income tax expense	(12)	(13)	(4)
Income (loss) from continuing operations	48	(297)	(116)
Loss from discontinued operations, net of income taxes	(577)	(587)	(288)
Net loss	(529)	(884)	(404)
Attributable to:			
Minority interests	(120)	(173)	(30)
Shareholders of Infineon Technologies AG	(409)	(711)	(374)

Basic and diluted earnings (loss) per share attributable to shareholders of Infineon Technologies AG (in Euro)*:

Weighted average shares outstanding (in million) – basic and diluted	750	750	750
Basic and diluted earnings (loss) per share from continuing operations	0.05	(0.45)	(0.16)
Basic and diluted loss per share from discontinued operations	(0.60)	(0.50)	(0.34)
Basic and diluted loss per share	(0.55)	(0.95)	(0.50)

Infineon consolidated Balance Sheet (IFRS)

in Euro million	Sep 30, 08	Dec 31, 08
Assets		
Current assets:		
Cash and cash equivalents	749	647
Available-for-sale financial assets	134	132
Trade and other receivables	799	521
Inventories	665	661
Income tax receivable	29	19
Other current financial assets	19	49
Other current assets	124	127
Assets classified as held for disposal	2,129	1,933
Total current assets	4,648	4,089
Property, plant and equipment	1,310	1,208
Goodwill and other intangible assets	443	428
Investments accounted for using the equity method	20	21
Deferred tax assets	400	411
Other financial assets	133	111
Other assets	28	21
Total assets	6,982	6,289
in Euro million	Sep 30, 08	Dec 31, 08
Liabilities and shareholders' equity		
Current liabilities:		
Short-term debt and current maturities of long-term debt	207	212
Trade and other payables	506	317
Current provisions	424	439
Income tax payable	87	99
Other current financial liabilities	63	77
Other current liabilities	263	231
Liabilities associated with assets classified as held for disposal	2,123	1,927
Total current liabilities	3,673	3,302
Long-term debt	963	860
Pension plans and similar commitments	43	42
Deferred tax liabilities	19	33
Long-term provisions	27	113
Other financial liabilities	20	3
Other liabilities	76	73
Total liabilities	4,821	4,426
Shareholders' equity:		
Ordinary share capital	1,499	1,499
Additional paid-in capital	6,008	6,008
Accumulated deficit	(5,252)	(5,626)
Other components of equity	(164)	(79)
Total equity attributable to shareholders of Infineon Technologies AG	2,091	1,802
Minority interests	70	61
Total equity	2,161	1,863
Total liabilities and equity	6,982	6,289

Infineon Condensed Consolidated Statements of Cash Flows (IFRS)



3 months ended	December 31, 2007 (€millions)	December 31, 2008 (€millions)
Net loss	(529)	(404)
Less: net loss from discontinued operations	577	288
Adjustments to reconcile net loss to cash provided by (used in) operating activities:		
Depreciation and amortization	147	145
Provision for doubtful accounts	-	1
Gains on sales of businesses and interests in subsidiaries	(28)	(1)
Losses (gains) on disposals of property, plant, and equipment	13	-
Income from investments accounted for using the equity method	-	(1)
Stock-based compensation	1	-
Deferred income taxes	-	3
Trade and other receivables	70	250
Inventories	(28)	5
Other current assets	(7)	(46)
Trade and other payables	(75)	(179)
Provisions	(29)	(66)
Other current liabilities	(16)	(5)
Other assets and liabilities	19	(8)
Interest received	8	9
Interest paid	(9)	(7)
Income tax received (paid)	4	21
Net cash provided by operating activities from continuing operations	118	5
Net cash used in operating activities from discontinued operations	(127)	(354)
Net cash used in operating activities	(9)	(349)
Cash flows from investing activities:		
Purchases of available-for-sale financial assets	(324)	-
Proceeds from sales of available-for-sale financial assets	-	5
Proceeds from sales of businesses and interests in subsidiaries	36	-
Business acquisitions, net of cash acquired	(316)	13
Purchases of intangible assets, and other assets	(13)	(11)
Purchases of property, plant and equipment	(98)	(29)
Proceeds from sales of property, plant and equipment	3	-
Net cash used in investing activities from continuing operations	(712)	(22)
Net cash provided by (used in) investing activities from discontinued operations	(64)	307
Net cash provided by (used in) investing activities	(776)	285
Cash flows from financing activities:		
Net change in short-term debt	-	10
Net change in related party financial receivables and payables	(3)	(2)
Proceeds from issuance of long-term debt	102	1
Principal repayments of long-term debt	(9)	(84)
Change in restricted cash	-	(1)
Dividend payments to minority interests	(65)	-
Capital contribution	-	(5)
Net cash provided by (used in) financing activities from continuing operations	25	(81)
Net cash provided by (used in) financing activities from discontinued operations	(38)	19
Net cash used in financing activities	(13)	(62)
Net decrease in cash and cash equivalents	(798)	(126)
Effect of foreign exchange rate changes on cash and cash equivalents	(8)	(9)
Cash and cash equivalents at beginning of period	1,809	1,171
Cash and cash equivalents at end of period	1,003	1,036
Less: Cash and cash equivalents at end of period from discontinued operations	502	389
Cash and cash equivalents at end of period from continuing operations	501	647

Financial Calendar

- Feb 12, 2009 **Annual General Meeting 2009, Munich**
- Feb 17, 2009 **Presentation at Mobile World Congress, Barcelona**
- Apr 30, 2009* **Q2 FY09 results**
- Jul 29, 2009* **Q3 FY09 results**
- Nov 19, 2009* **Q4 FY09 and full year results**

* = Preliminary Date