

Package Outline

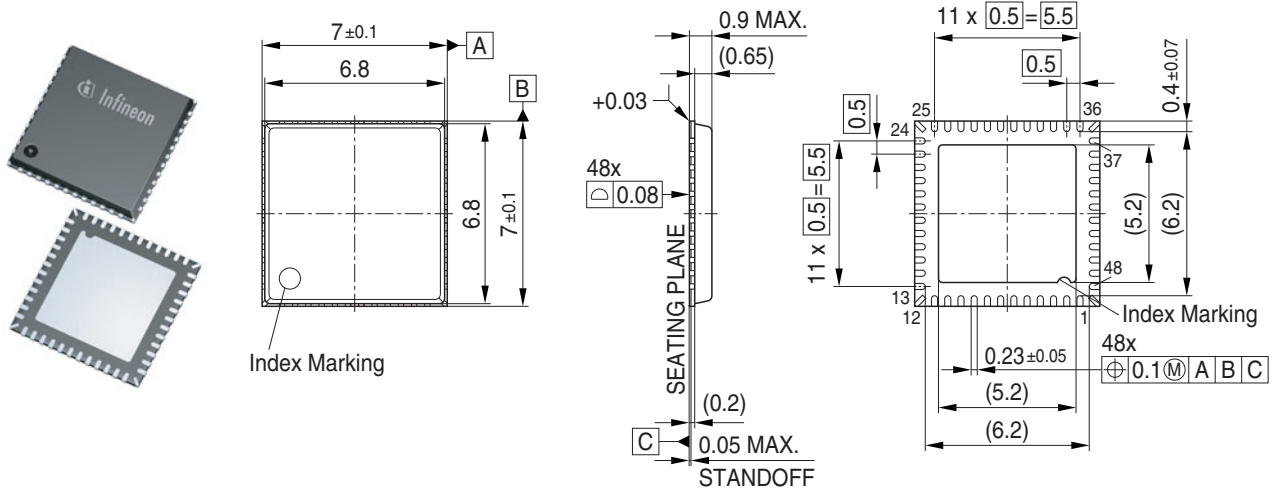

Foot Print

Soldering Type: Reflow Soldering

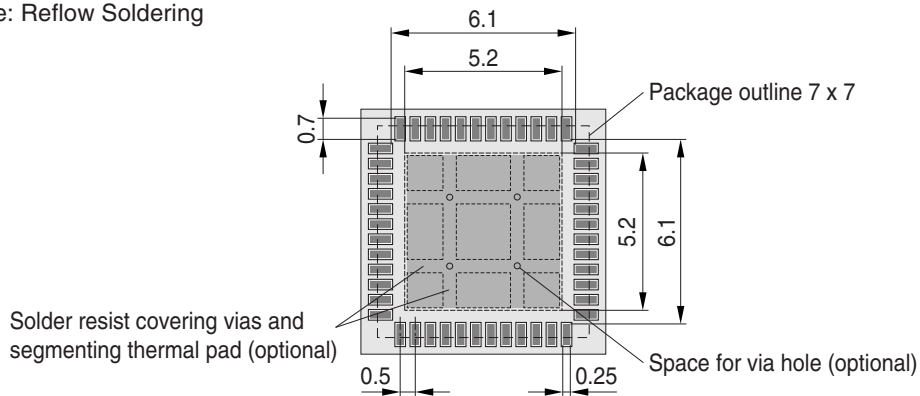

Marking Layout

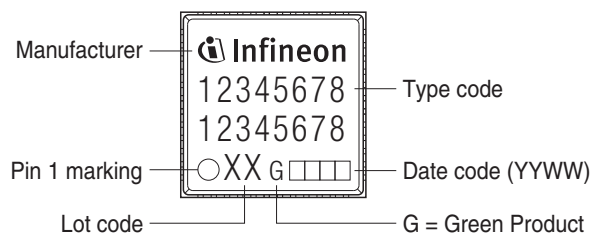

Tape and Reel

Reel \varnothing 330 mm: 2.500 Pieces/Reel
 Reels/Box: 1 x 2.500 = 2.500

