

XMC4800 IoT Amazon FreeRTOS Connectivity kit WiFi with EtherCAT® Kit-V1.0

For XMC4000 family

About this document

Scope and purpose

This document provides a hardware description of the XMC4800 IoT Amazon FreeRTOS Connectivity kit with EtherCAT® including schematics and list of material. For fast software development you can find the mapping of XMC4800 functions to the on-board components in various tables.

Intended audience

This document is intended for anyone who wants to develop software on the XMC4800 IoT Amazon FreeRTOS Connectivity kit with EtherCAT® or wants to use this kit for evaluating and demonstrating the capabilities of the XMC4800 microcontroller.

Table of contents

About this document	1
Table of contents	1
1 Introduction	2
1.1 Key features	2
1.2 Block diagram	3
2 Hardware description	4
2.1 Power supply.....	4
2.2 Arduino compatible connector	5
2.3 mikroBUS™ socket	7
2.4 User push buttons and user LEDs.....	8
2.5 Debugging and UART-to-USB communication	8
2.5.1 On-board debug probe.....	8
2.5.2 Cortex® debug connector (10-pin).....	8
2.6 Reset.....	9
2.7 CAN transceiver.....	9
2.8 Phy-2-Phy EtherCAT® connection	9
3 Production data	11
3.1 Schematics.....	11
3.2 Components placement and geometry.....	16
3.3 Bill of material.....	16
Revision history	19

Introduction

1 Introduction

This document describes the features and hardware details of the XMC4800 IoT Amazon FreeRTOS Connectivity kit with EtherCAT® equipped with an ARM® Cortex®-M4 based XMC microcontroller from Infineon Technologies AG.

It can be used with a wide range of development tools including Infineon’s free of charge Eclipse based IDE DAVE . The XMC4800 IoT Amazon FreeRTOS Connectivity kit with EtherCAT® is designed to evaluate the capabilities of the XMC4800 microcontroller especially in EtherCAT® slave applications. Table 1 shows the kit specification.

This kit includes the WiFi module mikroBUS from MikroElektronica based on ESP-WROOM-02 device. More Information about this module can be found [here](#).

Table 1 Kit specification

Processor	Infineon’s ARM® Cortex®-M4 XMC4800 microcontroller running at 144 MHz in LQFP100 package (order number XMC4800-F100K2048 AA)
RAM memory	352 kByte SRAM
Flash memory	2 MB of Flash
Dimensions	75 x 138 mm (91 x 144 mm with connectors incl. Phy-2-Phy)
Clock crystals	12 MHz and 32.768 kHz crystal for CPU
Power	<ul style="list-style-type: none"> • Via USB connector (Micro-AB USB) or • Via On-Board Debugger (Micro-AB USB)
Connectors	<ul style="list-style-type: none"> • EtherCAT® Slave IN and OUT interface via RJ45 jack • mikroBUS™ socket (2x8-pin) • Arduino compatible connectors (1x10-pin, 2x8-pin, 1x6pin, 2x3pin) • USB connector (Micro-AB USB) • CAN connector (D-Sub DE-9) • EtherCAT® Phy-2-Phy connector (not assembled) • Serial Wire Debug interface (2x5, 50 mil pitch) to XMC™ (not assembled) (on board debugger can be overridden by externally connected debugger)
Debugger	<p>On-Board J-Link debug probe via USB supporting</p> <ul style="list-style-type: none"> • Serial Wire Debug (SWD) • UART-to-USB bridge (virtual COM)
Others	<ul style="list-style-type: none"> • On-board debug probe, based on XMC4200 microcontroller • 2x EtherCAT® Phys • CAN transceiver • 2 user push-buttons, • 2 user LEDs • Reset push-button

1.1 Key features

The XMC4800 IoT Amazon FreeRTOS Connectivity kit with EtherCAT® has the following key features and components:

- XMC4800 microcontroller (ARM® Cortex®-M4 based), 144 MHz, 2MB Flash, 352 kB SRAM, LQFP100 package
- On-board debug probe with USB interface supporting SWD + SWO
- Virtual COM port via on-board debug probe
- EtherCAT® slave components: 2 EtherCAT® phys and 2 RJ45 jacks
- Prepared for EtherCAT® Phy-2-Phy connection for backplane applications (assembly option)
- Arduino compatible connector and voltage level shifter for 3.3 V / 5 V Arduino shields
- mikroBUS™ socket for plug-and-play click boards™
- CAN transceiver and CAN connector (D-Sub DE-9)

Introduction

- USB interface (Micro-AB USB plug)
- Voltage regulator 5 V -> 3.3 V
- 2 x User push-buttons
- 2 x User LED
- Reset push-button
- 12 MHz crystal
- 32.768 kHz RTC crystal

1.2 Block diagram

The block diagram in Figure 1 shows the main components of the XMC4800 IoT Amazon FreeRTOS Connectivity kit with EtherCAT® and their interconnections. There are following main building blocks:

- XMC4800 microcontroller in a LQFP100 package
- On-board USB debug probe based on XMC4200 for SWD, SWV and Virtual COM port support
- 2 EtherCAT® Phy with 2 RJ45 plugs
- Connection Header for Arduino
- mikroBUS™ socket
- 2 User push-buttons, 2 User LEDs, Reset push-button
- Micro-AB USB Plug
- CAN transceiver

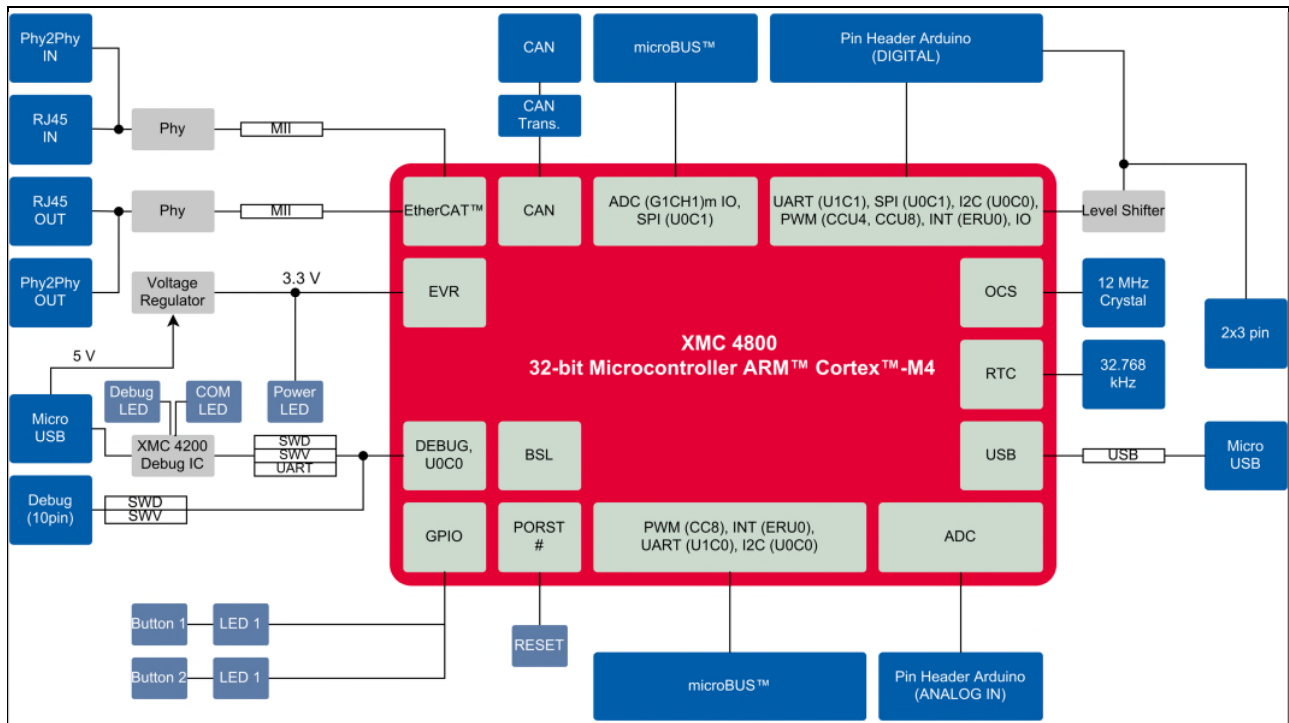

Figure 1 Block diagram of the XMC4800 IoT Amazon FreeRTOS Connectivity kit with EtherCAT®

Hardware description

2 Hardware description

The following chapters provide a detailed description of the hardware and how it can be used. The hardware is depicted in Figure 2.

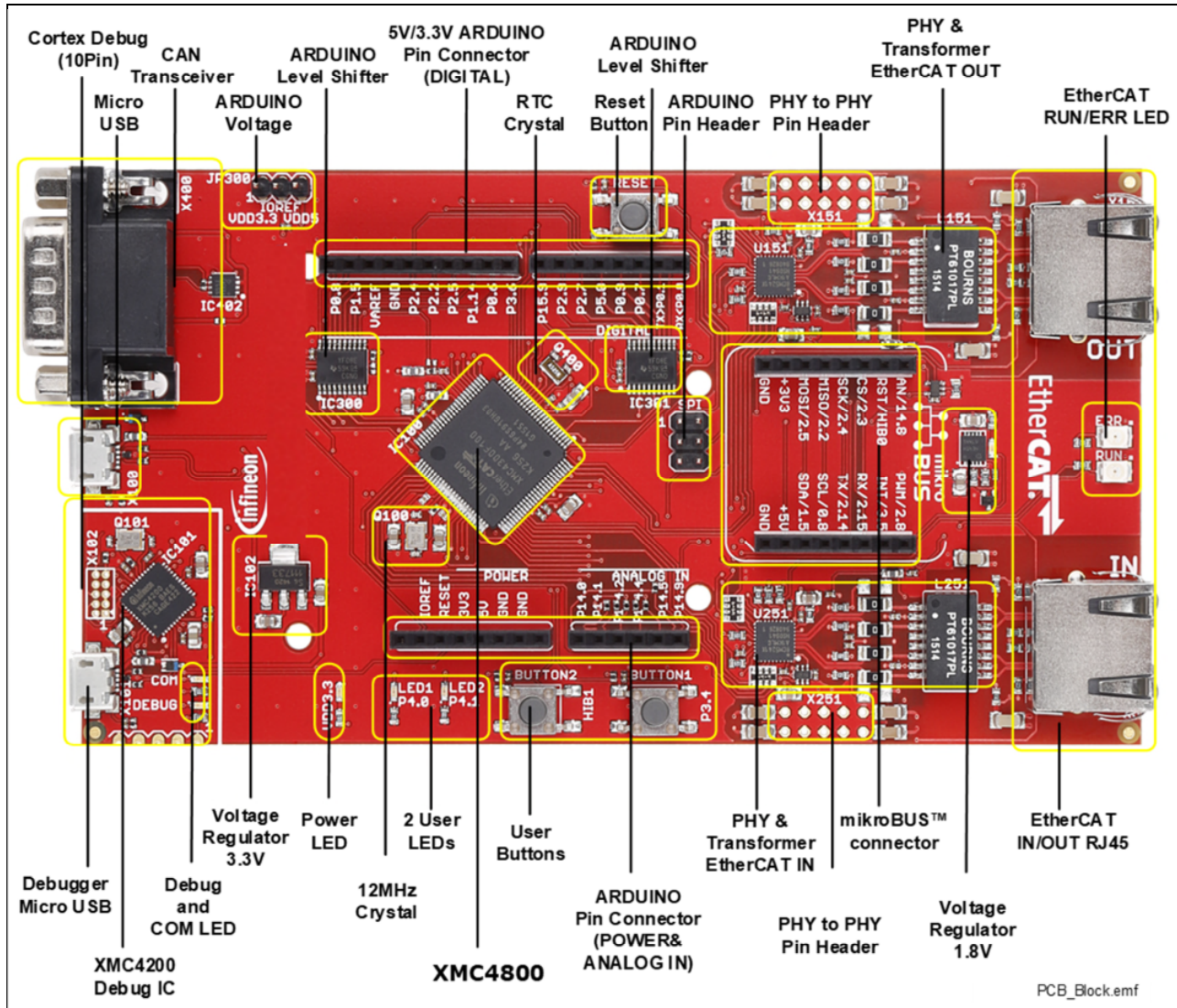

Figure 2 PCB of the XMC4800 IoT Amazon FreeRTOS Connectivity kit with EtherCAT®

2.1 Power supply

The XMC4800 IoT Amazon FreeRTOS Connectivity kit with EtherCAT® must be supplied by an external 5 volt DC power supply connected to any of the micro USB plugs (X100, X101). Out of the box with the pre-programmed EtherCAT® slave application and the on-board debug probe in operation, the XMC4800 IoT Amazon FreeRTOS Connectivity kit with EtherCAT® typically draws about 440 mA in an EtherCAT® environment. This current can be delivered via the USB plug of a PC, which is specified to deliver up to 500 mA. The green Power LED (VDD3.3) indicates the presence of the generated 3.3 V supply voltage.

On-board reverse current protection diodes will ensure safe operation when power is provided through both USB plugs at the same time. These protection diodes allows to use the on-board debug probe connected with a PC/Notebook via X101 and a second host PC/Laptop connected with the XMC4800 IoT Amazon FreeRTOS Connectivity kit with EtherCAT® via X100.

Hardware description

If the board is powered via a USB plug, it is not recommended to apply an additional 5 Volt power supply to one of the 5 Volt power pins (VDD5, 5 V) on the Arduino headers or mikroBUS™ socket, because there is no protection against reverse current into the external power supply. These power pins can be used to power an external circuit, but care must be taken not to draw more current than USB can deliver. A PC acting as a USB host can typically deliver up to 500 mA current. If higher currents are required and in order to avoid damage to the USB host, the use of an external USB power supply which is able to deliver higher currents than 500 mA is strongly recommended.

After power-up the green DEBUG LED starts blinking. When there is a connection to a PC via the Debug USB plug X101 and the USB Debug Device drivers are installed on this PC, the DEBUG LED will turn from blinking to constant illumination.

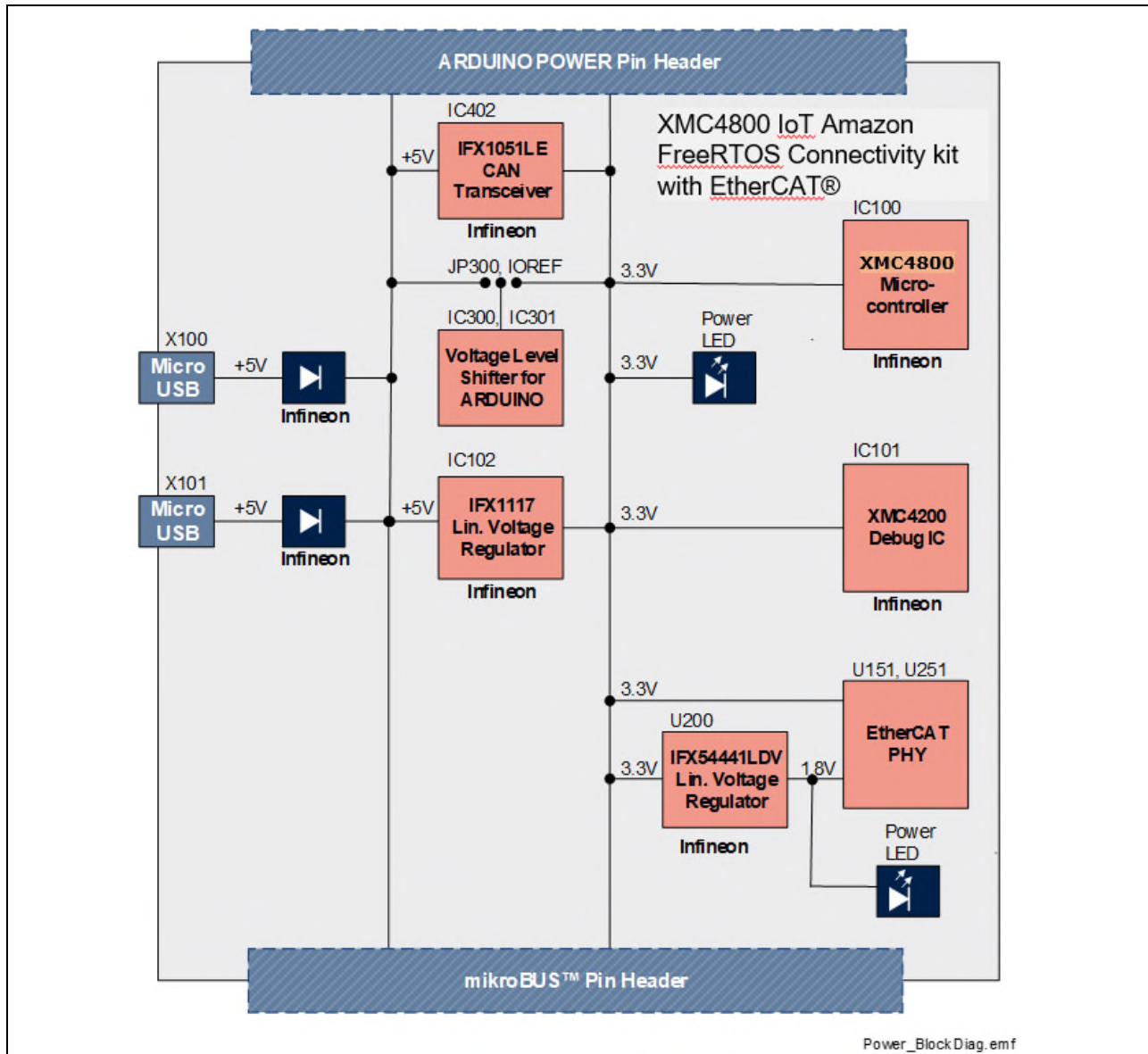

Figure 3 Power supply concept

2.2 Arduino compatible connector

The mapping of GPIOs and XMC™ pin functions to Arduino compatible functions can be found in Figure 4. The Arduino compatible connector supports

Hardware description

- SPI interface (SPI_XXX)
- I2C interface (I2C_XXX)
- UART interface (UART_XXX)
- PWM signal outputs (PWM0-5)
- ADC input (ADC0-5)
- Interrupt input (INT0-1)
- Reset

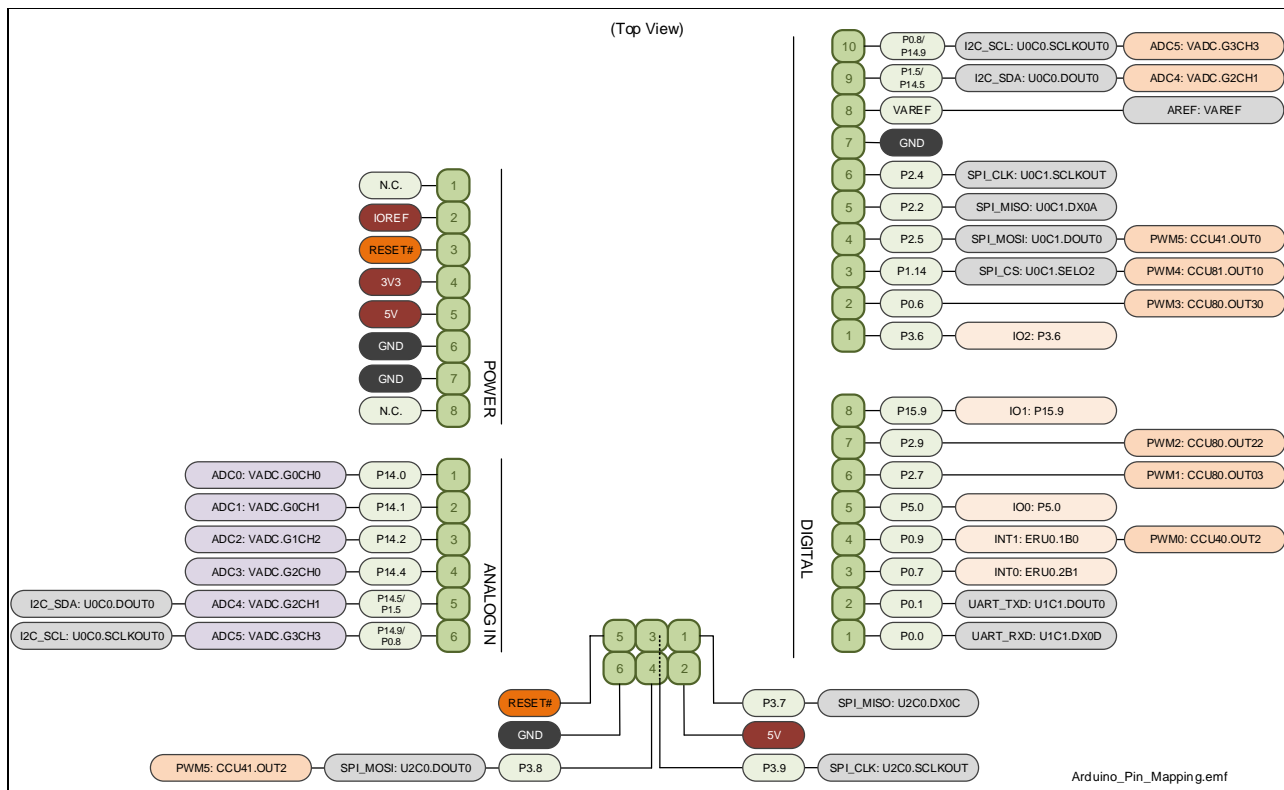

Figure 4 Mapping of Arduino™ functions to XMC™ pin functions

The XMC4800 IoT Amazon FreeRTOS Connectivity kit with EtherCAT® features a bi-directional voltage level shifter and therefore supports 5 V Arduino shields as well as 3.3 V Arduino shields. Jumper JP300 (IOREF) determines whether the Arduino shield is driven with 5 V or 3.3 V.

The analog input signals (ADC0-5) are limited to 3.3 V input voltage. A serial 100 Ohm resistor protects the analog input pin against overcurrent.

Primarily, ADC0 to ADC3 should be used as analog inputs, because there is no additional circuit connected to these pins, whereas ADC4 and ADC5 have additional circuitry and require an input signal with low input impedance (<500 Ohm).

Note: Parallel operation of I2C and ADC4 / ADC5 is not possible, because they share the same Arduino pins.

Hardware description

2.3 mikroBUS™ socket

This kit includes the WiFi module mikroBUS™ from MikroElektronika based on ESP-WROOM-02 device. More Information about this module can be found in the link: <https://www.mikroe.com/wifi-esp-click>

The mapping of GPIOs and XMC™ pin functions to mikroBUS™ functions can be found in Table 5. The mikroBUS™ connector supports

- SPI interface with one chip select (SPI_XXX)
- I2C interface (I2C_XXX)
- UART interface (UART_XXX)
- PWM signal output (PWM)
- ADC input (ADC)
- Interrupt input (INT)
- Reset (RST)

Attention: Jumper JP300 (IOREF) must be set to 3.3 V (VDD3.3) when using click™ boards. 5 V click™ boards cannot be used with the XMC4300 Relax EtherCAT® Kit.

Note: The mikroBUS™ UART and debugger's UART shares the same USIC channel (U1C0) of the XMC4800 device, but do not share the same pins. Parallel operation by time multiplexing is possible.

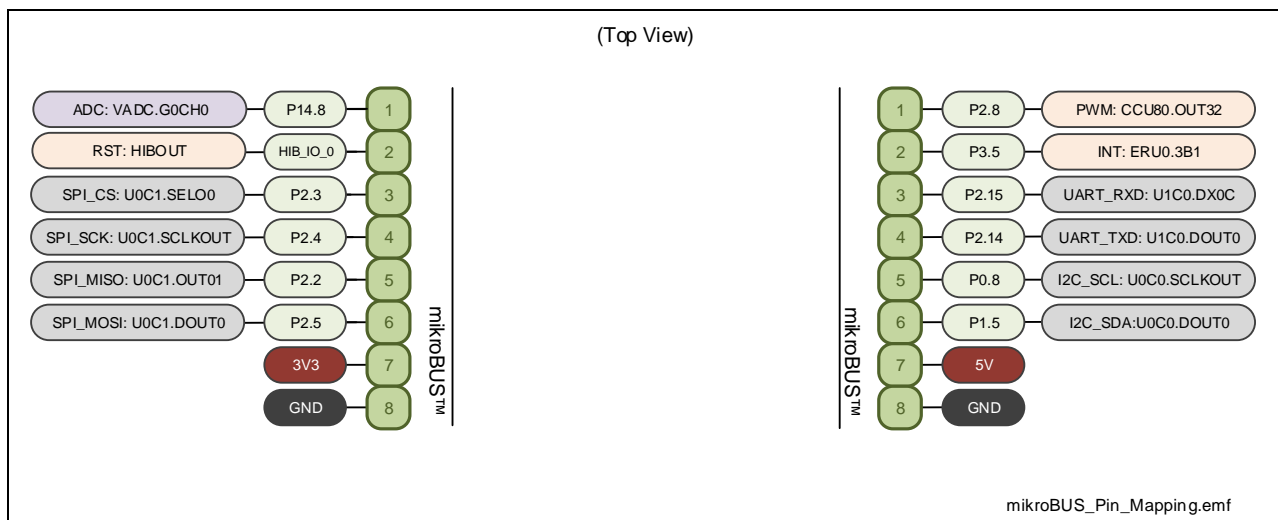

Figure 5 Mapping of Arduino™ functions to XMC™ pin functions

Hardware description

2.4 User push buttons and user LEDs

The XMC4800 IoT Amazon FreeRTOS Connectivity kit with EtherCAT® provides two push buttons and two LEDs. The port pins used can be found in Table 2 and Table 3. These pins are used exclusively for this function and they are not mapped to other devices or connectors.

Table 2 XMC4800 pin mapping for user LEDs

LED	XMC pin
LED1	P4.0
LED2	P4.1

Table 3 XMC4800 pin mapping for user push buttons

Button	XMC pin
BUTTON1	P3.4
BUTTON2	HIB_IO_1

2.5 Debugging and UART-to-USB communication

The XMC4800 IoT Amazon FreeRTOS Connectivity kit with EtherCAT® supports debugging via 2 different channels:

- On-board debug probe
- 10-pin Cortex® Debug connector (not assembled)

2.5.1 On-board debug probe

The on-board debug probe supports Serial Wire Debug (SWD) and UART communication. Both require the installation of Segger's J-Link Driver which is part of the DAVE™ installation. DAVE™ is a highly efficient development platform for the XMC® microcontroller families to simplify and shorten software development. It can be downloaded at www.infineon.com/dave. The latest Segger J-Link Driver can be downloaded at <http://www.segger.com/jlink-software.html>. Table 4 shows the pin assignment of the XMC4800 used for debugging and UART communication.

Table 4 XMC4800 pins mapping for debugging and UART-communication

Pin function	Input/Output	XMC Pin
Data pin for debugging via SWD	I/O	TMS
Clock pin for debugging via SWD	O	TCK
Transmit pin for UART communication (PC_RXD)	O	P0.5 (U1C0.DOUT0)
Receive pin for UART communication (PC_TXD)	I	P0.4 (U1C0.DX0A)

2.5.2 Cortex® debug connector (10-pin)

The 10-pin Cortex® debug connector supports Serial Wire Debug (SWD) and Serial Wire Viewer (SWV). The pin assignment of the Cortex® debug connector is shown in Table 5.

Table 5 Pin assignment of the Cortex® Debug Connector (X102)

Pin No.	Signal name	Description
1	VCC	+3.3 V
2	TMS	Serial Wire Data I/O
3	GND	Ground
4	TCK	Serial Wire Clock

Hardware description

Pin No.	Signal name	Description
5	GND	Ground
6	SWV	Serial Wire Viewer (Trace Data Out)
7	Key	Key
8	NC	Not connected
9	GND_Detect	Ground detect
10	RESET	Rest (active low)

2.6 Reset

The reset pin (PORST#) of the XMC4800 is a bi-directional pin in open drain mode. An internal pull-up resistor keeps the PORST# pin high during normal operation. A low level at this pin will force a hardware reset. In case of a MCU internal reset the PORST# pin will drive a low signal.

A reset signal can be issued by

- the on-board Reset Button (SW102, "RESET")
- the on-board debug probe (IC101.46)
- the external debugger connected to the 10-pin Cortex® debug probe connector (X102)
- the Arduino Power Header (RESET)
- the mikroBUS™ socket (RST)

An XMC™ internal circuit always ensures a safe Power-on-Reset. The XMC™ does not require any additional external components to generate a reset signal during power-up.

2.7 CAN transceiver

The XMC4800 IoT Amazon FreeRTOS Connectivity kit with EtherCAT® provides a CAN interface via a D-Sub DE-9 connector. Infineon's high speed CAN transceiver {IFX1051LE} for industrial applications supports 3.3V I/O logic and is suitable for 12 V and 24 V bus systems with an excellent EMC performance. The CAN bus (signals CANH, CANL) are terminated by a 120 Ohm resistor.

Table 6 CAN signals and XMC4800 pin mapping

Signal name	Pin no. at D-Sub DE-9 (X400)	XMC Pin, XMC function
CANH	X400.7	-
CANL	X400.2	-
CAN_TX	-	P2.0, CAN.N0_TXD
CAN_RX	-	P14.3, CAN.N0_RXDB
GND	X400.3, X400.6	-
VDD5	X400.9 (needs to be connected)	-

2.8 Phy-2-Phy EtherCAT® connection

For backplane/mid-plane oriented EtherCAT® applications, communication can be implemented without using isolation transformers. Instead, low-cost ceramic capacitors can be used. The PCB layout of the XMC4800 IoT Amazon FreeRTOS Connectivity kit with EtherCAT® has been prepared for EtherCAT® operation through direct Phy-2-Phy connection.

For this purpose two XMC4800 IoT Amazon FreeRTOS Connectivity kit with EtherCAT® are required and some modifications must be made to the kits (see Figure 6). All components required for this modification can be found attached to the kit.

Hardware description

- Remove four 0 Ohm resistors from each XMC4800 IoT Amazon FreeRTOS Connectivity kit with EtherCAT®
- Solder two 0 Ohm resistors onto each XMC4800 IoT Amazon FreeRTOS Connectivity kit with EtherCAT®
- Solder the connectors onto the XMC4800 IoT Amazon FreeRTOS Connectivity kit with EtherCAT®

After this modification EtherCAT® communication through the RJ45 is disabled.

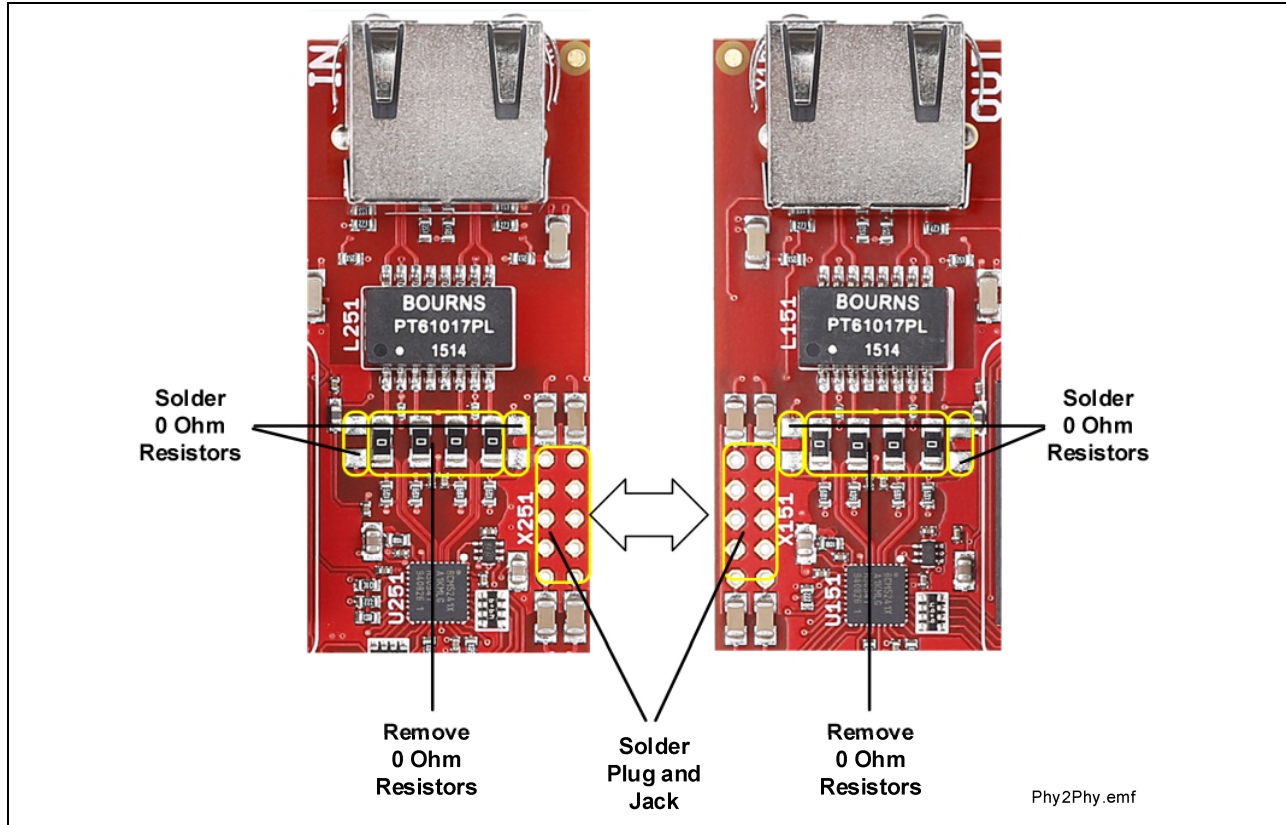

Figure 6 Phy-2-Phy EtherCAT® connection between two XMC4800 IoT Amazon FreeRTOS Connectivity kit with EtherCAT®

3 Production data

This chapter covers schematics, board dimensions, component placement and the bill of material.

3.1 Schematics

The following figures show the schematics of the XMC4800 IoT Amazon FreeRTOS Connectivity kit with EtherCAT® in hardware version 1.0:

- Figure 7: Schematic: MCU, Push Buttons, LEDs, Reset Button, Crystals, USB
- Figure 8: Schematic: EtherCAT® Phys, Magnetics, Phy-2-Phy
- Figure 9: Schematic: Arduino, mikroBUS, CAN
- Figure 10: Schematic: On-Board Debug Probe, Power Supply

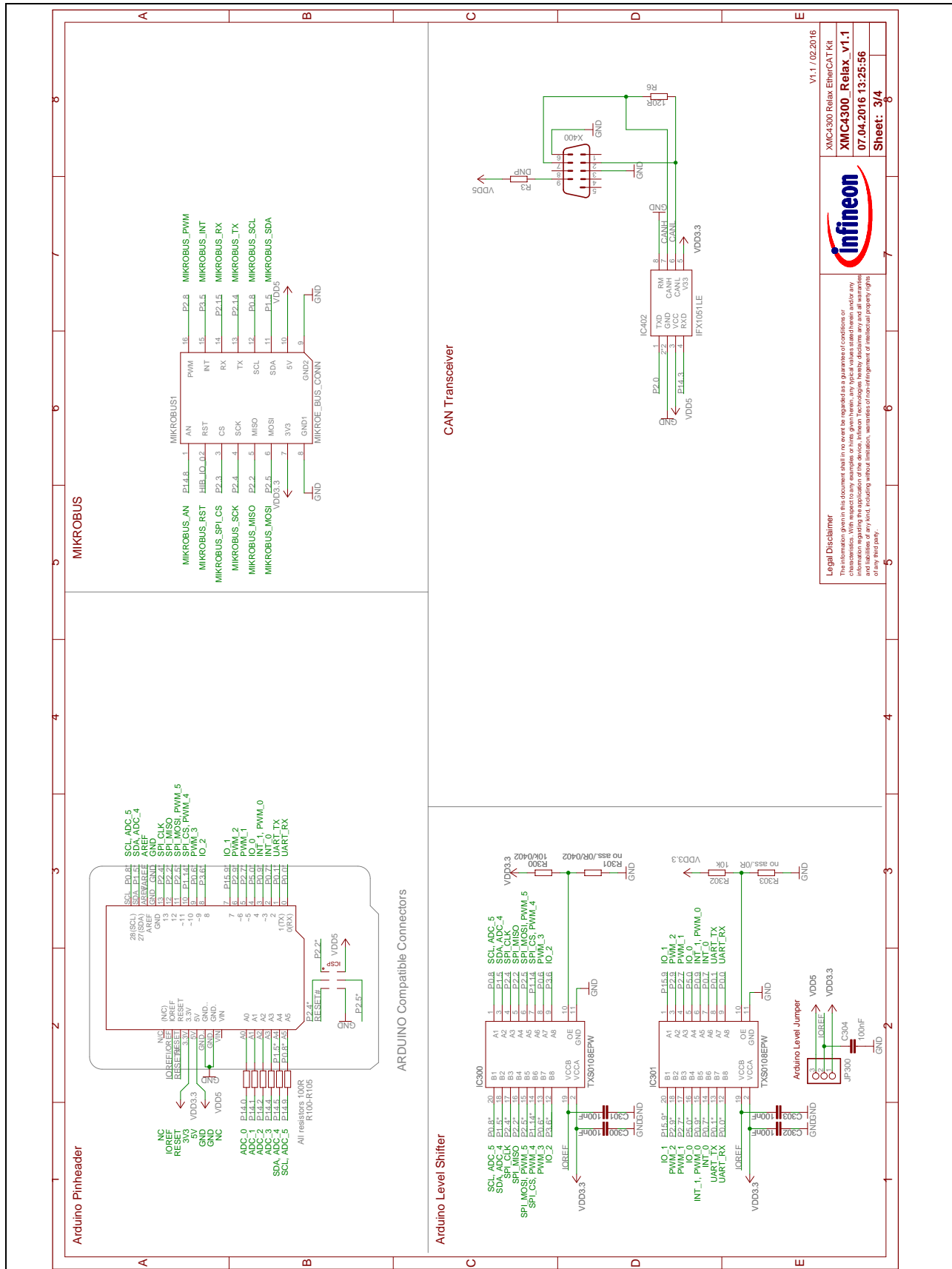

Figure 9 Schematic: Arduino, mikroBUS, CAN

Production data

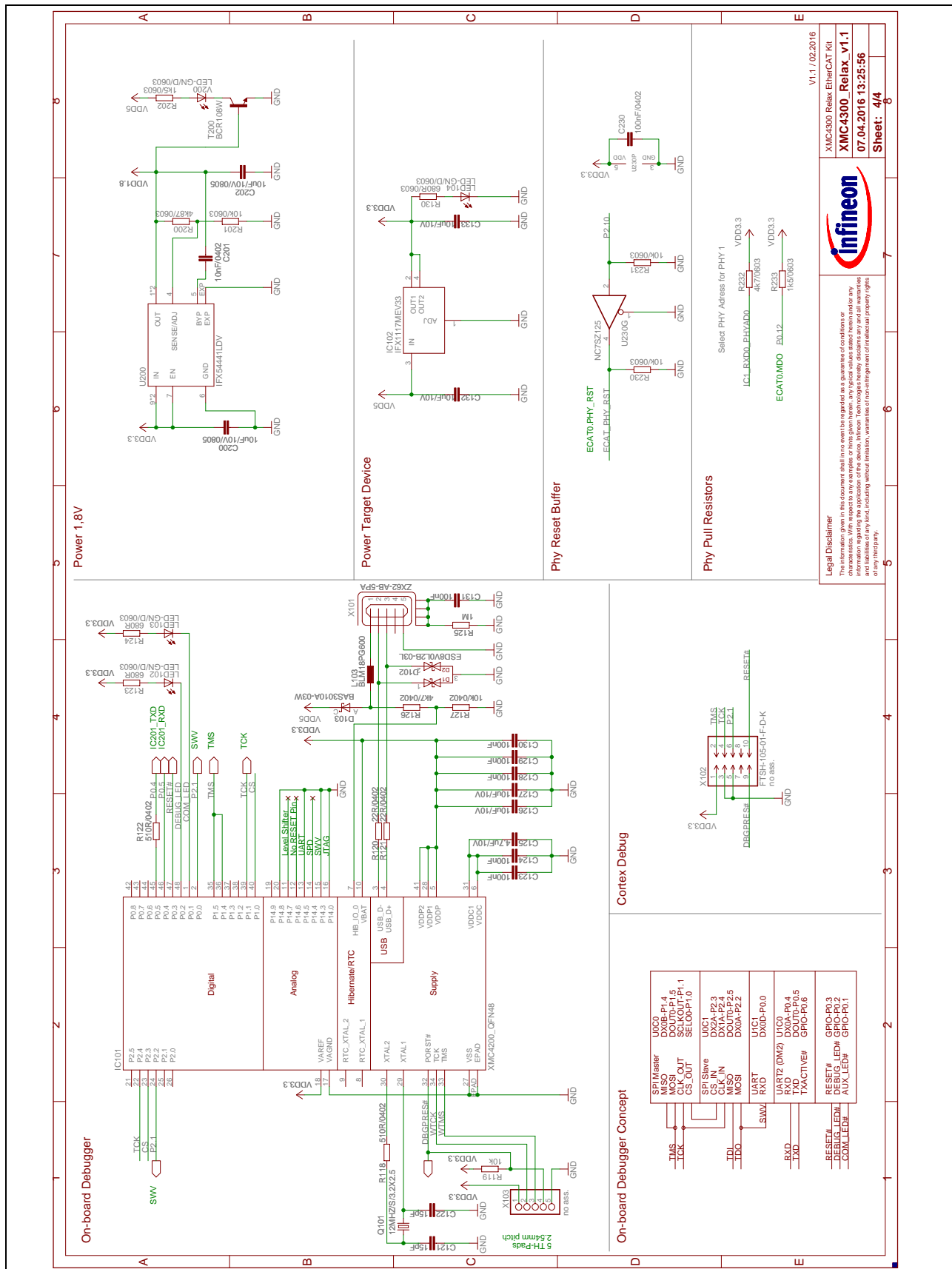

Figure 10 Schematic: On-Board Debug Probe, Power Supply

3.2 Components placement and geometry

Figure 11 shows the board dimensions and the placement of components on the PCB.

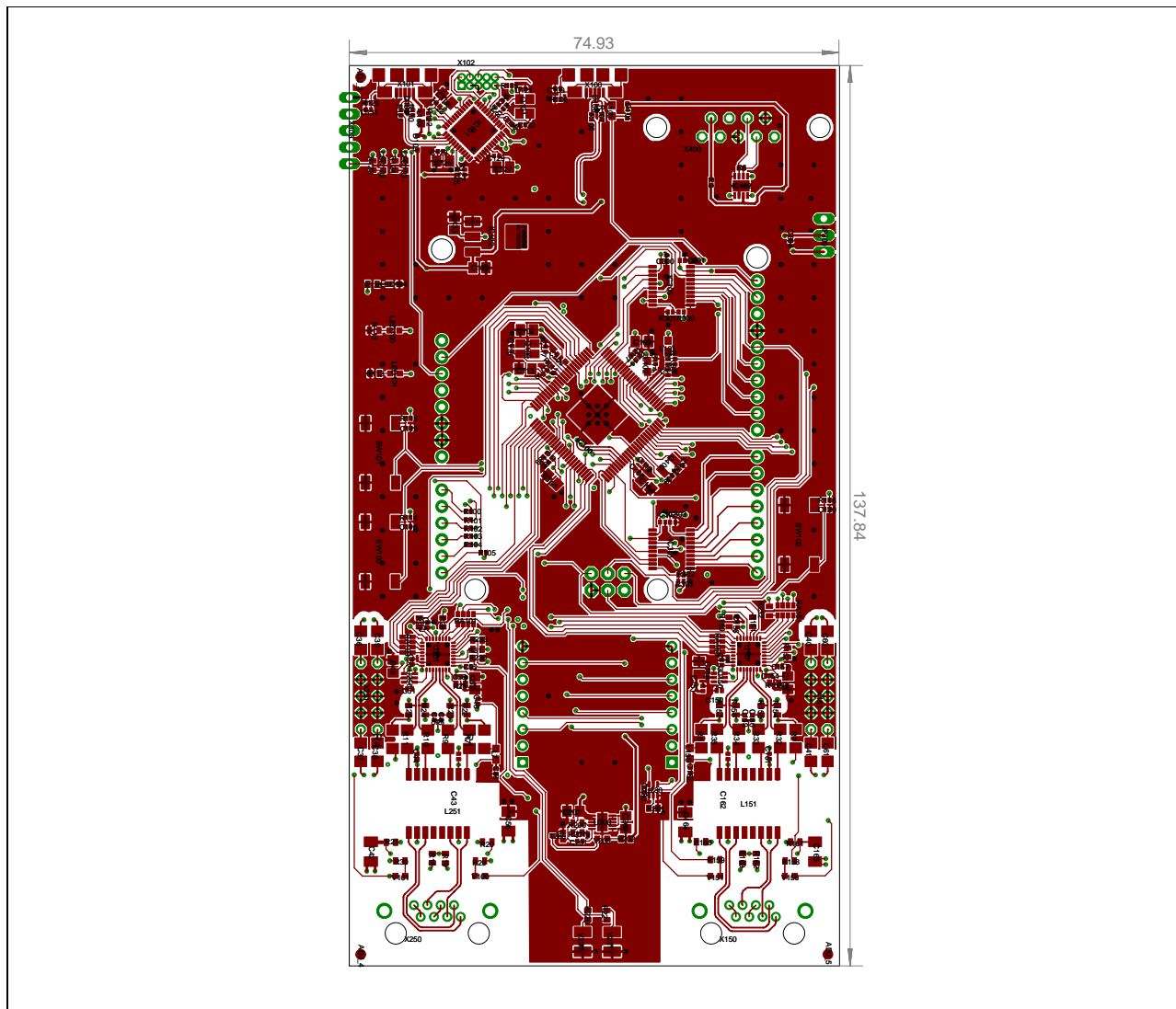

Figure 11 Components placement and geometry

3.3 Bill of material

The BOM is valid for the XMC4800 IoT Amazon FreeRTOS Connectivity kit with EtherCAT® in hardware version 1.0.

Table 7 List of material

Value	Device	Qty	Reference designator
IFX1051LE TSON8	CAN transceiver Infineon	1	IC402
15pF 50V 10% 0402	Capacitor COG	6	C116, C117, C121, C122, C400, C401
1000pF 2kV 10% 1206	Capacitor X5R	4	C42, C56, C163, C164
10nF 50V 10% 0402	Capacitor X5R	1	C120, C201
4.7uF 10V 10% 0805	Capacitor X5R	1	C125

Production data

Value	Device	Qty	Reference designator
100 nF 50 V 10% 0402	Capacitor X7R	47	C43, C44, C45, C46, C47, C48, C50, C51, C53, C54, C55, C100, C105, C106, C107, C108, C109, C110, C111, C112, C114, C115, C118, C119, C123, C124, C128, C129, C130, C131, C150, C151, C152, C153, C154, C156, C157, C159, C160, C161, C162, C230, C300, C301, C302, C303, C304
100 nF 50 V 10% 1206	Capacitor X7R	8	C36, C37, C38, C39, C40, C41, C60, C61
10 uF 10 V 10% 0805	Capacitor X7R	15	C49, C52, C101, C102, C103, C104, C113, C126, C127, C132, C133, C155, C158, C200, C202
ARDUINO_UNO_V2	Connection Headers for Arduino UNO	1	PCB1
MIKROE_BUS_CONN	Connection Headers for mikroBus	1	MIKROBUS1
DSUB9-male	Connector D-SUB male 9pol R/A THT	1	X400
ZX62-AB-5PA	Connector Micro USB AB SMD Hirose	2	X100, X101
43860-0010	Connector RJ45 R/A Molex	2	X150, X250
12 MHz 3.2x2.5	Crystal 12 MHz 4Pad NX3225SA 12 MHz NDK	2	Q100, Q101
32.768KHz 3.2x1.5	Crystal 32.768 KHz SMD 12.5pF NDK NX3215SA-32.768K	1	Q400
ESD8V0L2B-03L TSLP-3-1	Diode protection Infineon	2	D100, D102
BAS3010A-03W SOD323	Diode Schottky 30 V 1 A Infineon	2	D101, D103
BCM5241XA1KMLG MLP-32	Ethernet PHY Broadcom	2	U151, U251
PT61017PEL	Ethernet Transformer 1:1 SMD Bourns	2	L151, L251
BLM18PG600SN1D 0603	Ferrite Bead 60R 500 mA Murata	6	L7, L100, L101, L102, L103, L150
NC7SZ157P6X	IC 2-Input Multiplexer	2	U150, U250
NC7SZ125	IC Buffer with 3-state output	1	U230
TXS0108EPW TSSOP-20	IC Level Shifter 8-bit	2	IC300, IC301
LED GN 0603	LED green SMD	6	LED102, LED103, LED104, V101, V151, V200
LED GE 0603	LED yellow SMD	2	V100, V150
LED GN P-LCC2	LED green SMD	1	V230
LED RT 0603	LED red SMD	2	LED100, LED101
LED RT P-LCC2	LED red SMD	1	V231
XMC4200-Q48K256 QFN48	Microcontroller XMC4200 Infineon	1	IC101
XMC4800-F100K2048 AA LQFP100	Microcontroller XMC4800 Infineon	1	IC100
no ass. 2x5-pin 0.1" female	Pin Header THT no assembly	1	X151
no ass. 2x5-pin 0.1" male	Pin Header THT no assembly	1	X251
3-pin 0.1"	Pin Header THT	1	JP300
no ass. 2x5pin 0.05"	Pin Header THT FTSH-105-01-F-D-K no assembly	1	X102
no ass. 5-pin 0.1"	Pin Header THT no assembly	1	X103
FSM2JSMA	Pushbutton ON SMD Tyco	3	SW100, SW101, SW102
0R 0402	Resistor	1	R110

Production data

Value	Device	Qty	Reference designator
0R 1206	Resistor	8	R7, R9, R10, R11, R32, R33, R34, R35
100R 1% 0402	Resistor	6	R100, R101, R102, R103, R104, R105
10k 1% 0402	Resistor	7	R114, R115, R116, R119, R127, R300, R302
10k 1% 0603	Resistor	3	R201, R230, R231
120R 1% 0402	Resistor	1	R6
1M 10% 0402	Resistor	2	R106, R125
1k24 1% 0603	Resistor	2	R26, R153
1k5 1% 0603	Resistor	2	R202, R233
22R 1% 0402	Resistor	2	R107, R108, R120, R121
270R 1% 0603	Resistor	4	R29, R30, R158, R159
2k2 1% 0603	Resistor	2	R31, R152
49R9 1% 0603	Resistor	12	R22, R23, R24, R25, R27, R28, R150, R151, R154, R155, R156, R157
4k7 1% 0402	Resistor	1	R126
4k7 1% 0603	Resistor	1	R232
4k87 1% 0603	Resistor	1	R200
510R 1% 0402	Resistor	3	R111, R118, R122
680R 1% 0603	Resistor	7	R112, R113, R123, R124, R130, R220, R221
75R 1/ 0603	Resistor	8	R18, R19, R20, R21, R160, R161, R162, R163
no ass. 0R 0402	Resistor	1	R3
no ass. 0R 0402	Resistor	1	R303
no ass. 0R 0402	Resistor	2	R109, R301
no ass. 0R 1206	Resistor	4	R1, R2, R4, R5
4*49R9 1% ARRAY4_0.8	Resistor Array	4	RA100, RA101, RA150, RA151
BCR108W SOT323	Transistor NPN Infineon	1	T200
IFX1117MEV33 SOT223	Voltage regulator 3.3 V Infineon	1	IC102
IFX54441LDV TSON-10	Voltage regulator adj. Infineon	1	U200



Production data

Revision history

Major changes since the last revision

Page or reference	Description of change

Trademarks of Infineon Technologies AG

μ HVIC™, μ IPM™, μ PFC™, AU-ConvertIR™, AURIX™, C166™, CanPAK™, CIPOS™, CIPURSE™, CoolDP™, CoolGaN™, COOLiR™, CoolMOS™, CoolSET™, CoolSiC™, DAVE™, DI-POL™, DirectFET™, DrBlade™, EasyPIM™, EconoBRIDGE™, EconoDUAL™, EconoPACK™, EconoPIM™, EiceDRIVER™, eupec™, FCOS™, GaNpowIR™, HEXFET™, HITFET™, HybridPACK™, iMOTION™, IRAM™, ISOFACE™, IsoPACK™, LEDrivIR™, LITIX™, MIPAQ™, ModSTACK™, my-d™, NovalithiC™, OPTIGA™, OptiMOS™, ORIGA™, PowIRaudio™, PowIRstage™, PrimePACK™, PrimeSTACK™, PROFET™, PRO-SiL™, RASIC™, REAL3™, SmartLEWIS™, SOLID FLASH™, SPOC™, StrongIRFET™, SupIRBuck™, TEMPFET™, TRENCHSTOP™, TriCore™, UHVIC™, XHP™, XMC™

Trademarks updated November 2015

Other Trademarks

All referenced product or service names and trademarks are the property of their respective owners.

EtherCAT® is registered trademark and patented technology, licensed by Beckhoff Automation GmbH, Germany.

Edition 2016-04-15

Published by

Infineon Technologies AG

81726 Munich, Germany

© 2019 Infineon Technologies AG.

All Rights Reserved.

Do you have a question about this document?

Email: erratum@infineon.com

**Document reference
UG_201604_PL30_017**

IMPORTANT NOTICE

The information contained in this application note is given as a hint for the implementation of the product only and shall in no event be regarded as a description or warranty of a certain functionality, condition or quality of the product. Before implementation of the product, the recipient of this application note must verify any function and other technical information given herein in the real application. Infineon Technologies hereby disclaims any and all warranties and liabilities of any kind (including without limitation warranties of non-infringement of intellectual property rights of any third party) with respect to any and all information given in this application note.

The data contained in this document is exclusively intended for technically trained staff. It is the responsibility of customer's technical departments to evaluate the suitability of the product for the intended application and the completeness of the product information given in this document with respect to such application.

For further information on the product, technology, delivery terms and conditions and prices please contact your nearest Infineon Technologies office (www.infineon.com).

WARNINGS

Due to technical requirements products may contain dangerous substances. For information on the types in question please contact your nearest Infineon Technologies office.

Except as otherwise explicitly approved by Infineon Technologies in a written document signed by authorized representatives of Infineon Technologies, Infineon Technologies' products may not be used in any applications where a failure of the product or any consequences of the use thereof can reasonably be expected to result in personal injury.