

# TVS3V3L4U

## Protection device

TVS (transient voltage suppressor)

Bi/uni-directional, 3.3 V, 2 pF, RoHS and halogen free compliant

## Feature list

- ESD/Transient/Surge protection according to:
  - IEC61000-4-2 (ESD):  $\pm 30$  kV (air/contact discharge)
  - IEC61000-4-4 (EFT):  $\pm 4$  kV/ $\pm 80$  A (5/50 ns)
  - IEC61000-4-5 (Surge):  $\pm 20$  A (8/20  $\mu$ s)
- Reverse working voltage up to:  $V_{RWM} = 3.3$  V
- Low leakage current:  $I_R < 50$  nA
- Low capacitance:  $C_L = 2$  pF (typical, I/O to GND), 1 pF (typical, I/O to I/O)
- Low clamping voltage:  $V_{CL} = 7.7$  V (typical) at  $I_{pp} = 20$  A (8/20  $\mu$ s)
- Pb-free (RoHS compliant) and halogen free package



## Potential applications

- 10/100/1000 Ethernet
- 4 lines uni-directional (pin 1, 3, 4, 6 to GND)
- 2 lines bi-directional (pin 2 n.c.)

## Product validation

Qualified for industrial applications according to the relevant tests of JEDEC47/20/22

## Device information

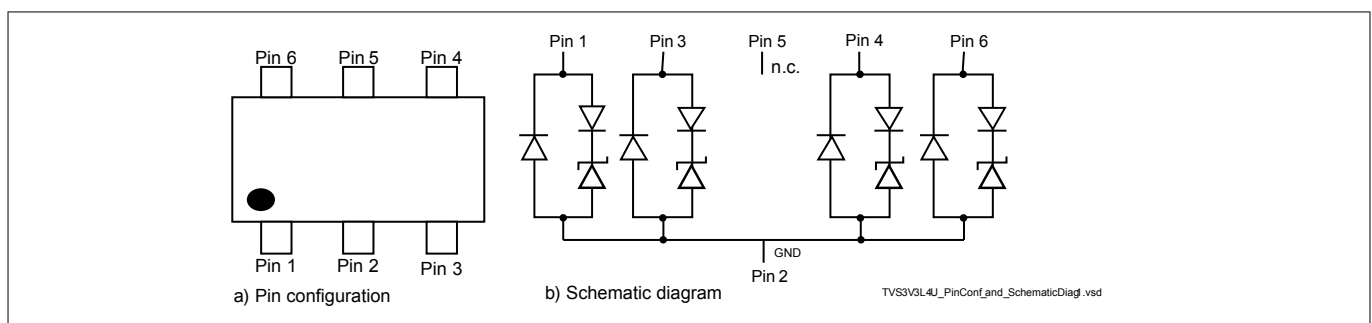

Figure 1 Pin configuration and schematic diagram

Table 1 Part information

Type	Package	Configuration	Marking code
TVS3V3L4U	SC74-6-2	4-lines uni-directional or 2-lines bi-directional	E1s

## Table of contents

	<b>Feature list</b> .....	1
	<b>Potential applications</b> .....	1
	<b>Product validation</b> .....	1
	<b>Device information</b> .....	1
	<b>Table of contents</b> .....	2
<b>1</b>	<b>Maximum ratings</b> .....	3
<b>2</b>	<b>Electrical characteristics</b> .....	4
<b>3</b>	<b>Typical characteristic diagrams</b> .....	6
<b>4</b>	<b>Package information</b> .....	12
4.1	SC74-6-2 package .....	12
<b>5</b>	<b>References</b> .....	13
	<b>Revision history</b> .....	13
	<b>Disclaimer</b> .....	14

**Maximum ratings**

**1 Maximum ratings**

Note:  $T_A = 25\text{ °C}$ , unless otherwise specified.

**Table 2 Maximum ratings**

Parameter	Symbol	Values		Unit	Note or test condition
		Min.	Max.		
ESD discharge <sup>1)</sup>	$V_{ESD}$	-30	30	kV	air
		-30	30		contact
Peak pulse current	$I_{pp}$	-20	20	A	$t_p = 8/20\ \mu\text{s}$ <sup>2)</sup>
Peak pulse power	$P_{PK}$	-	154	W	$t_p = 8/20\ \mu\text{s}$ <sup>2)</sup>
		-	1044		$t_p = 100\ \text{ns}$ <sup>3)</sup>
Operating temperature	$T_{OP}$	-55	125	°C	-
Storage temperature	$T_{stg}$	-55	150		-

**Attention:** Stresses above the maximum values listed here may cause permanent damage to the device. Exposure to absolute maximum rating conditions for extended periods may affect device reliability. Maximum ratings are absolute ratings. Exceeding only one of these values may cause irreversible damage to the component.

<sup>1</sup>  $V_{ESD}$  according to IEC61000-4-2

<sup>2</sup>  $I_{pp}$  according to IEC61000-4-5.  $P_{PK}$  is calculated by  $I_{pp} \times V_{CL}$

<sup>3</sup> Please refer to AN210 [1].  $P_{PK}$  is calculated by  $I_{TLP} \times V_{CL}$

**Electrical characteristics**

**2 Electrical characteristics**

Note:  $T_A = 25\text{ }^\circ\text{C}$ , unless otherwise specified.

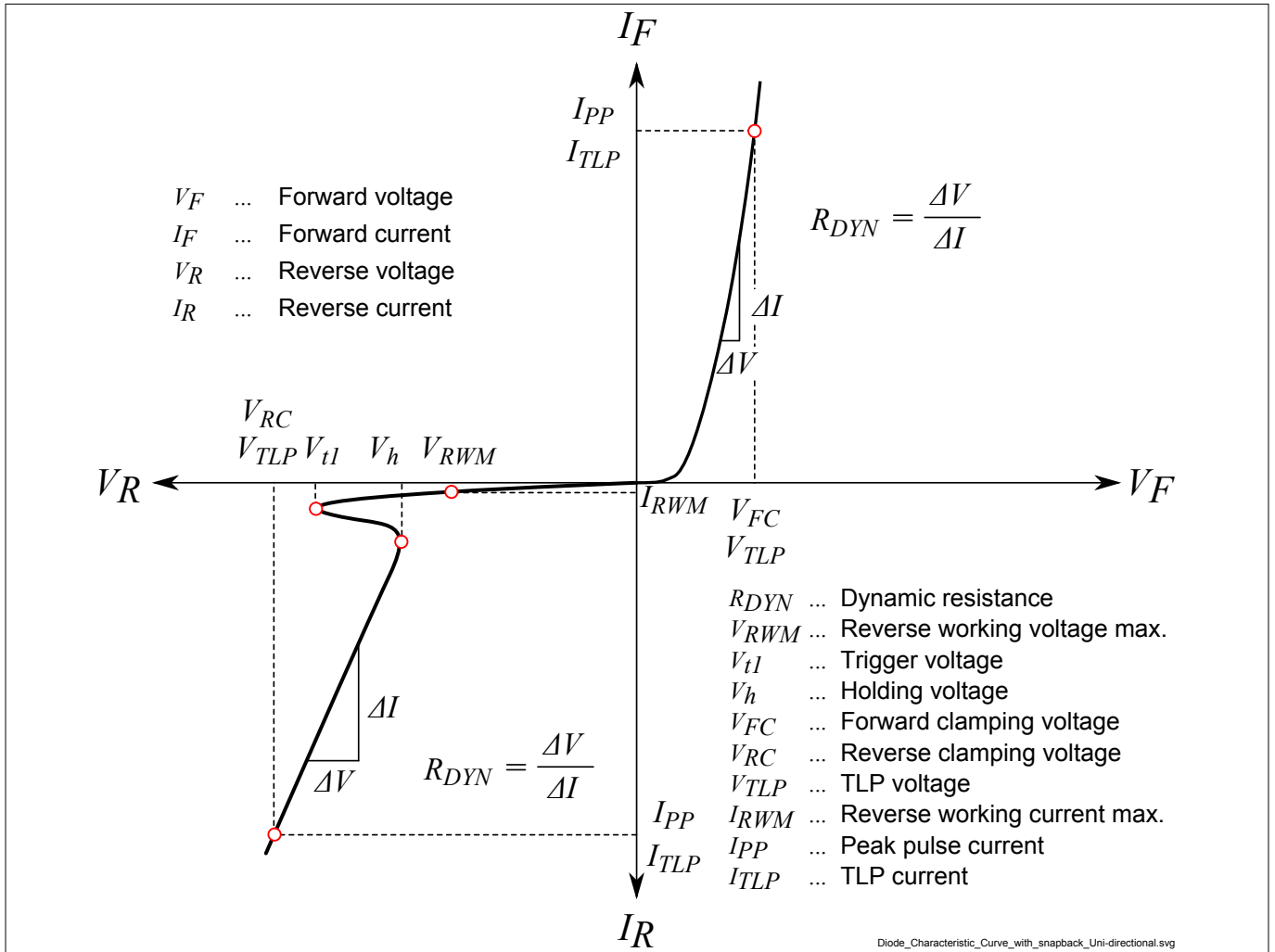

**Figure 2** Definitions of electrical characteristics

**Electrical characteristics**

**Table 3 DC characteristics**

Parameter	Symbol	Values			Unit	Note or test condition
		Min.	Typ.	Max.		
Reverse working voltage	$V_{RWM}$	–	–	3.3	V	–
Reverse current	$I_R$	–	–	50	nA	$V_R = 3.3$ V

**Table 4 RF characteristics**

Parameter	Symbol	Values			Unit	Note or test condition
		Min.	Typ.	Max.		
Line capacitance	$C_L$	–	2	3	pF	I/O to GND, $V_R = 0$ V, $f = 1$ MHz
		–	1	–		I/O to I/O, $V_R = 0$ V, $f = 1$ MHz

**Table 5 ESD characteristics**

Parameter	Symbol	Values			Unit	Note or test condition
		Min.	Typ.	Max.		
Reverse clamping voltage <sup>1)</sup>	$V_{CL}$	–	4.2	–	V	I/O to GND, $t_p = 8/20$ $\mu$ s, $I_{PP} = 1$ A
		–	4.9	–		I/O to GND, $t_p = 8/20$ $\mu$ s, $I_{PP} = 5$ A
		–	5.8	–		I/O to GND, $t_p = 8/20$ $\mu$ s, $I_{PP} = 10$ A
		–	6.7	–		I/O to GND, $t_p = 8/20$ $\mu$ s, $I_{PP} = 15$ A
		–	7.7	–		I/O to GND, $t_p = 8/20$ $\mu$ s, $I_{PP} = 20$ A
Reverse clamping voltage <sup>2)</sup>		–	5.8	–		I/O to GND, $t_p = 100$ ns, $I_{PP} = 16$ A
Forward clamping voltage <sup>1)</sup>	$V_{FC}$	–	1.1	–		GND to I/O, $t_p = 8/20$ $\mu$ s, $I_{PP} = 1$ A
		–	4	–		GND to I/O, $t_p = 8/20$ $\mu$ s, $I_{PP} = 20$ A
Forward clamping voltage <sup>2)</sup>		–	3.1	–		GND to I/O, $t_p = 100$ ns, $I_{PP} = 16$ A
Dynamic resistance <sup>1)</sup>	$R_{DYN}$	–	0.15	–	$\Omega$	I/O to GND, $t_p = 8/20$ $\mu$ s
Dynamic resistance <sup>2)</sup>		–	0.09	–		I/O to GND, $t_p = 100$ ns

<sup>1)</sup>  $I_{PP}$  according to IEC61000-4-5

<sup>2)</sup> Please refer to application note AN210 [1], TLP parameters:  $Z_0 = 50$   $\Omega$ ,  $t_p = 100$  ns,  $t_r = 300$  ps, averaging window:  $t_1 = 30$  ns to  $t_2 = 60$  ns, extraction of dynamic resistance using least squares fit of TLP characteristics between  $I_{PP1} = 10$  A and  $I_{PP2} = 40$  A

Typical characteristic diagrams

### 3 Typical characteristic diagrams

Note:  $T_A = 25\text{ }^\circ\text{C}$ , unless otherwise specified.

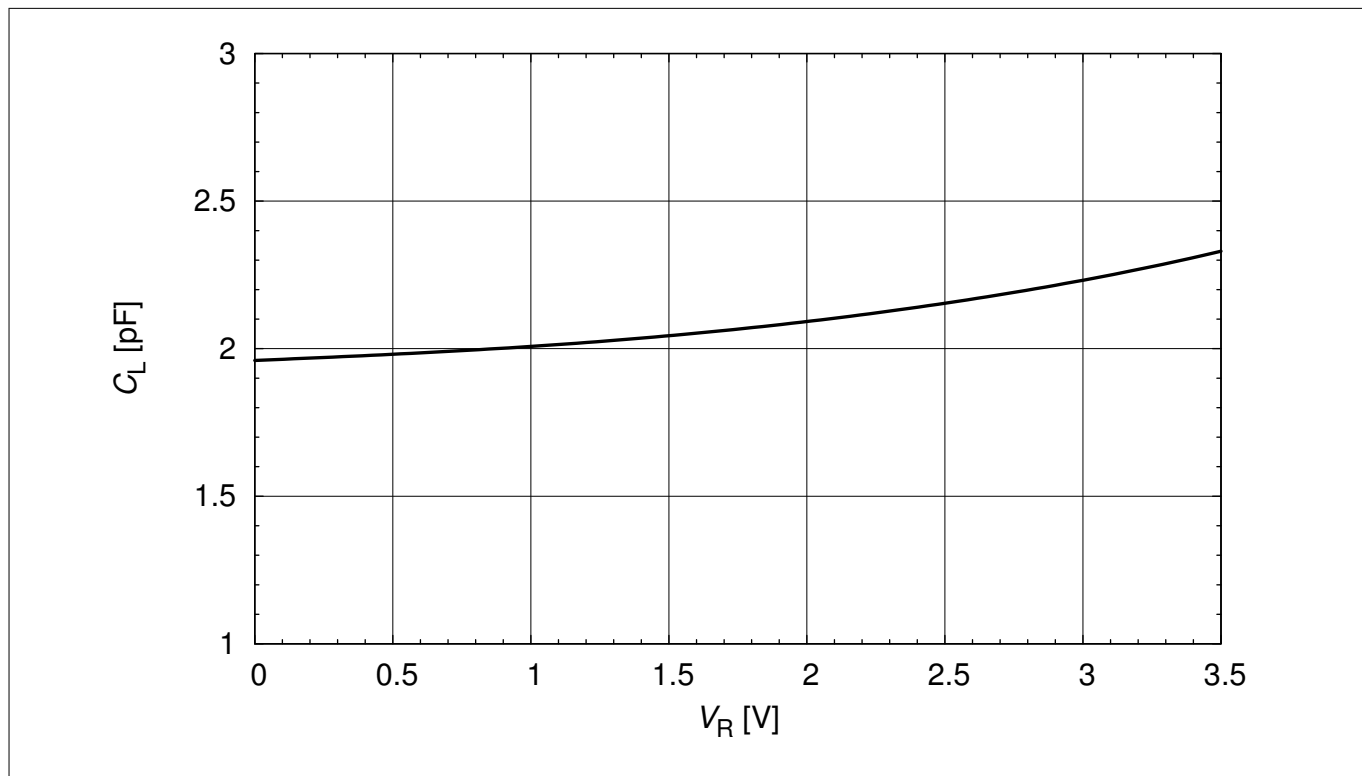

Figure 3 Line capacitance:  $C_L = f(V_R)$

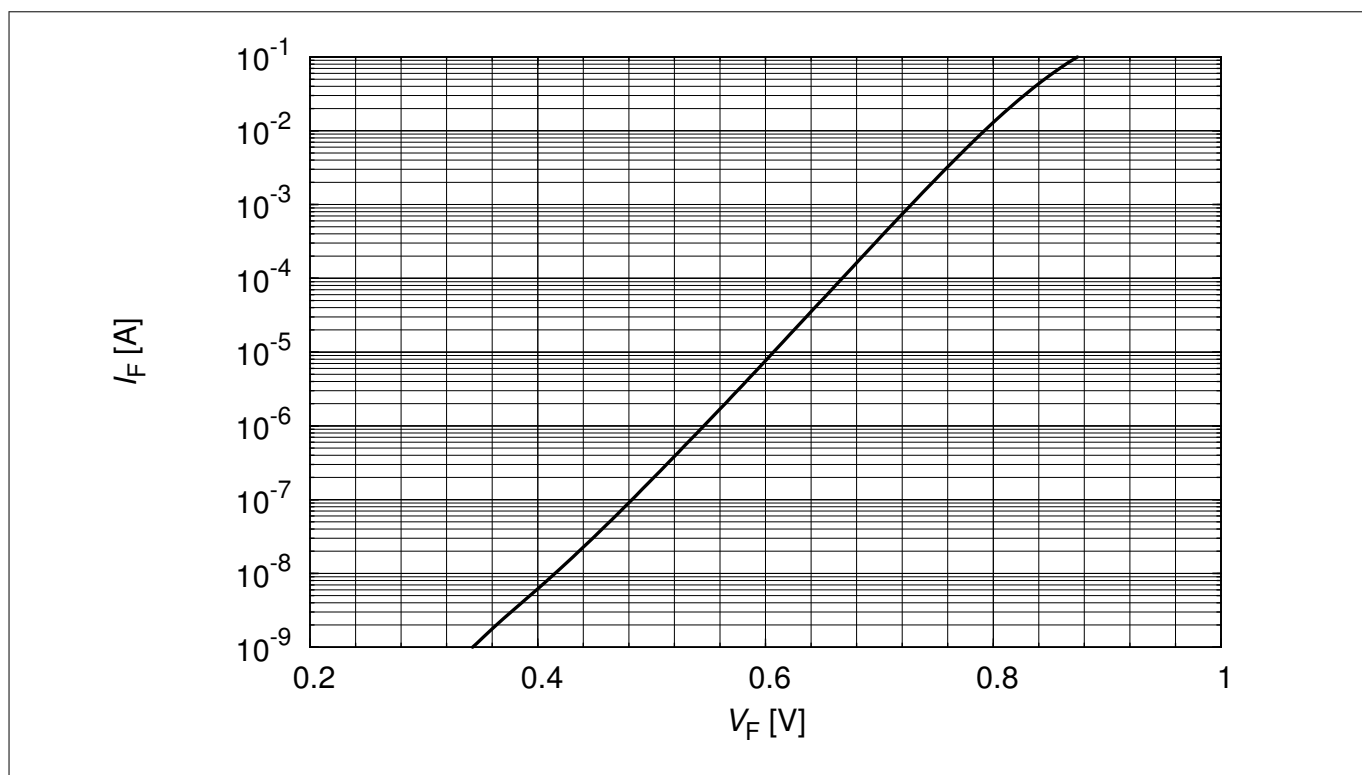

Figure 4 Forward characteristic:  $I_F = f(V_F)$

Typical characteristic diagrams

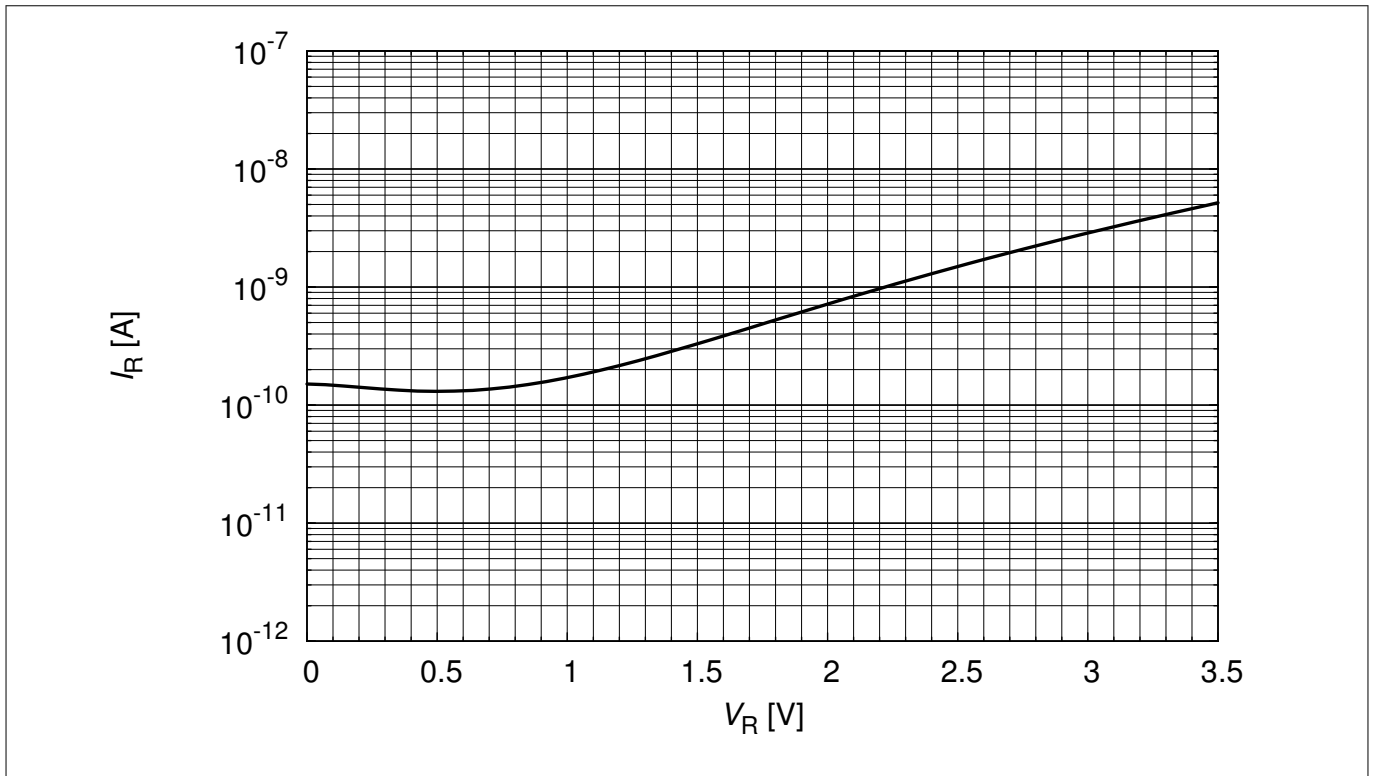

Figure 5 Reverse current:  $I_R = f(V_R)$

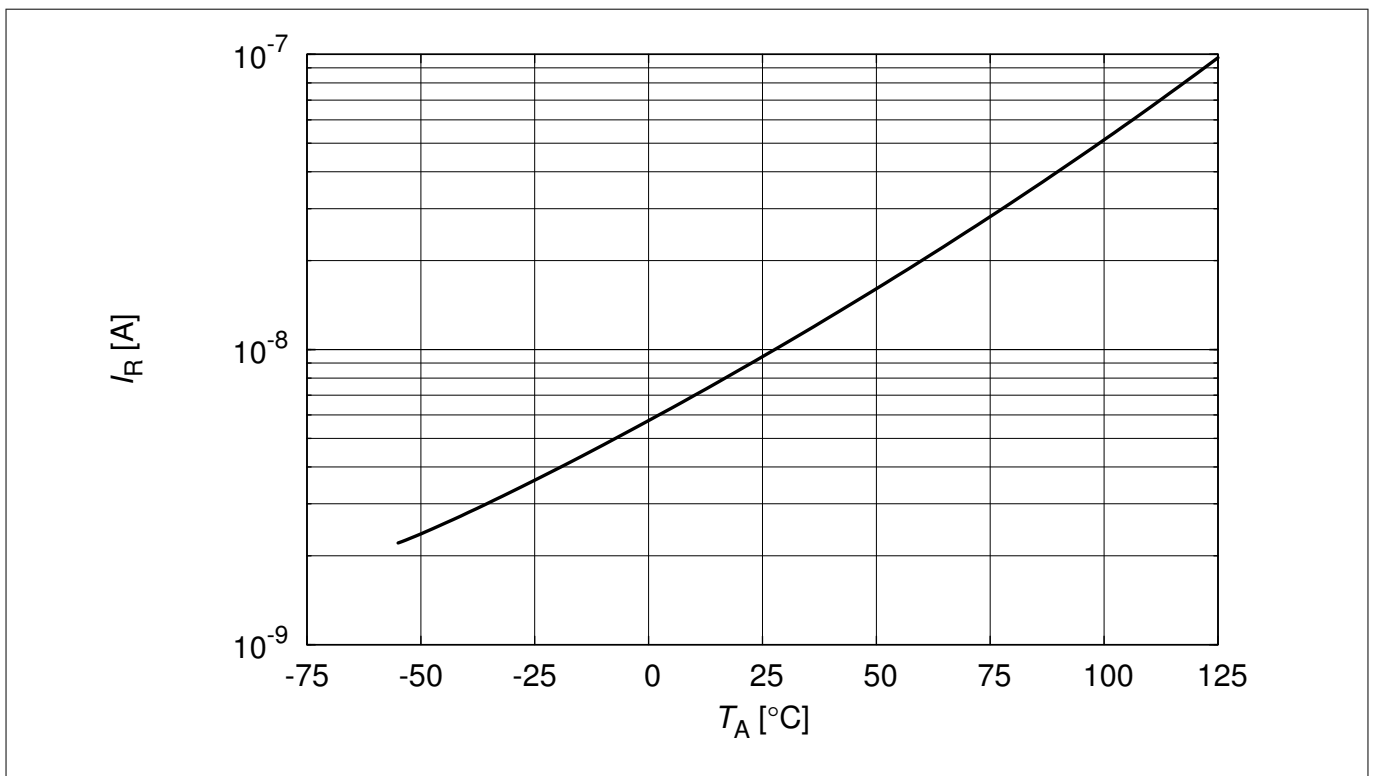

Figure 6 Reverse current:  $I_R = f(T_A)$ ,  $V_R = 3.3$  V

Typical characteristic diagrams

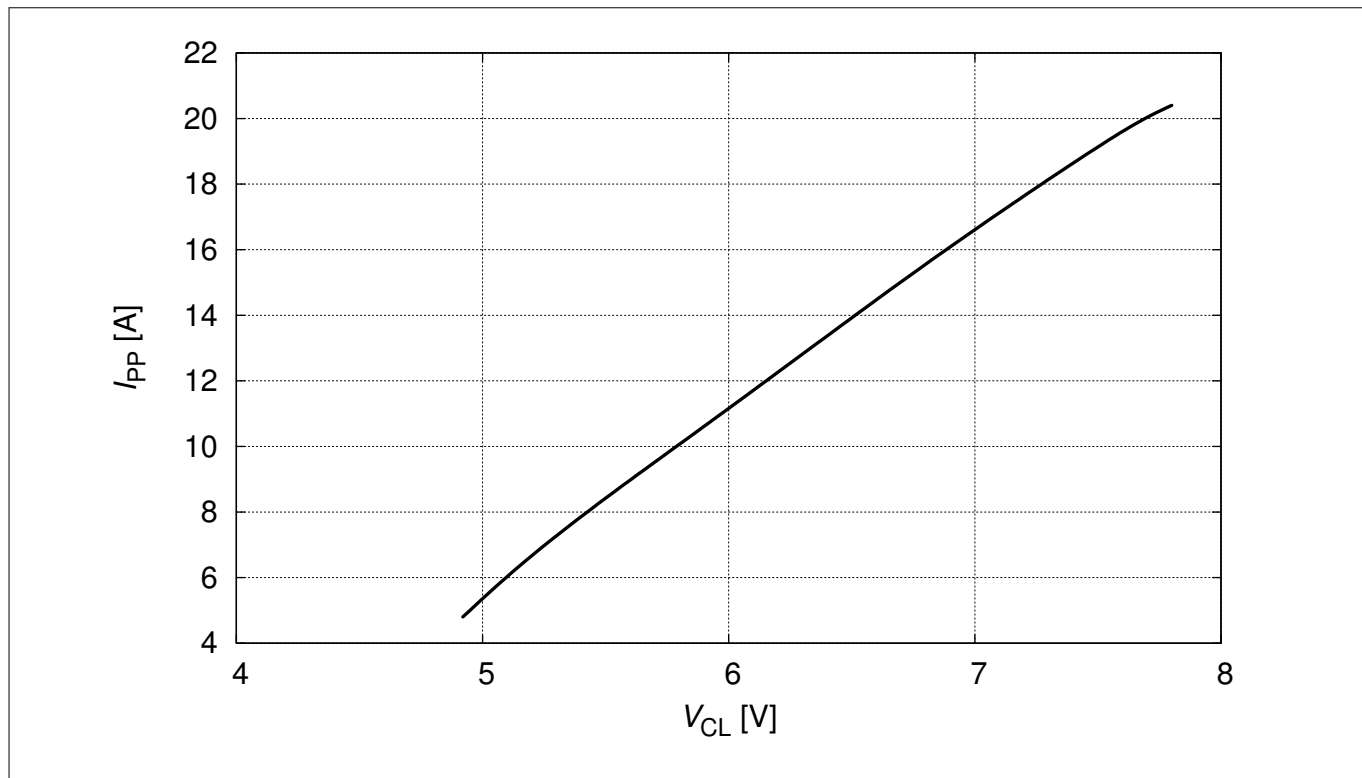

Figure 7 Pulse reverse current versus clamping voltage:  $I_{PP} = f(V_{CL})$ , according to IEC61000-4-5

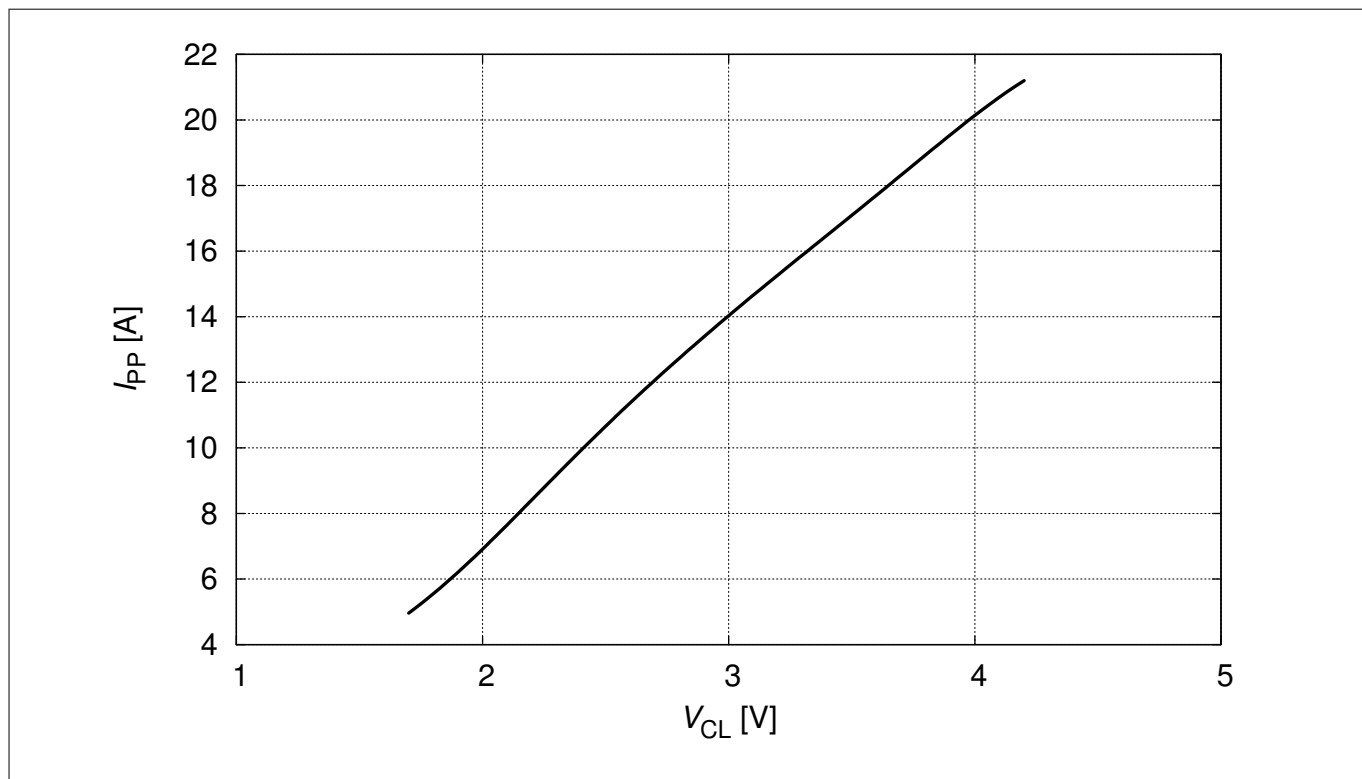

Figure 8 Pulse forward current versus clamping voltage:  $I_{PP} = f(V_{CL})$ , according to IEC61000-4-5



Typical characteristic diagrams

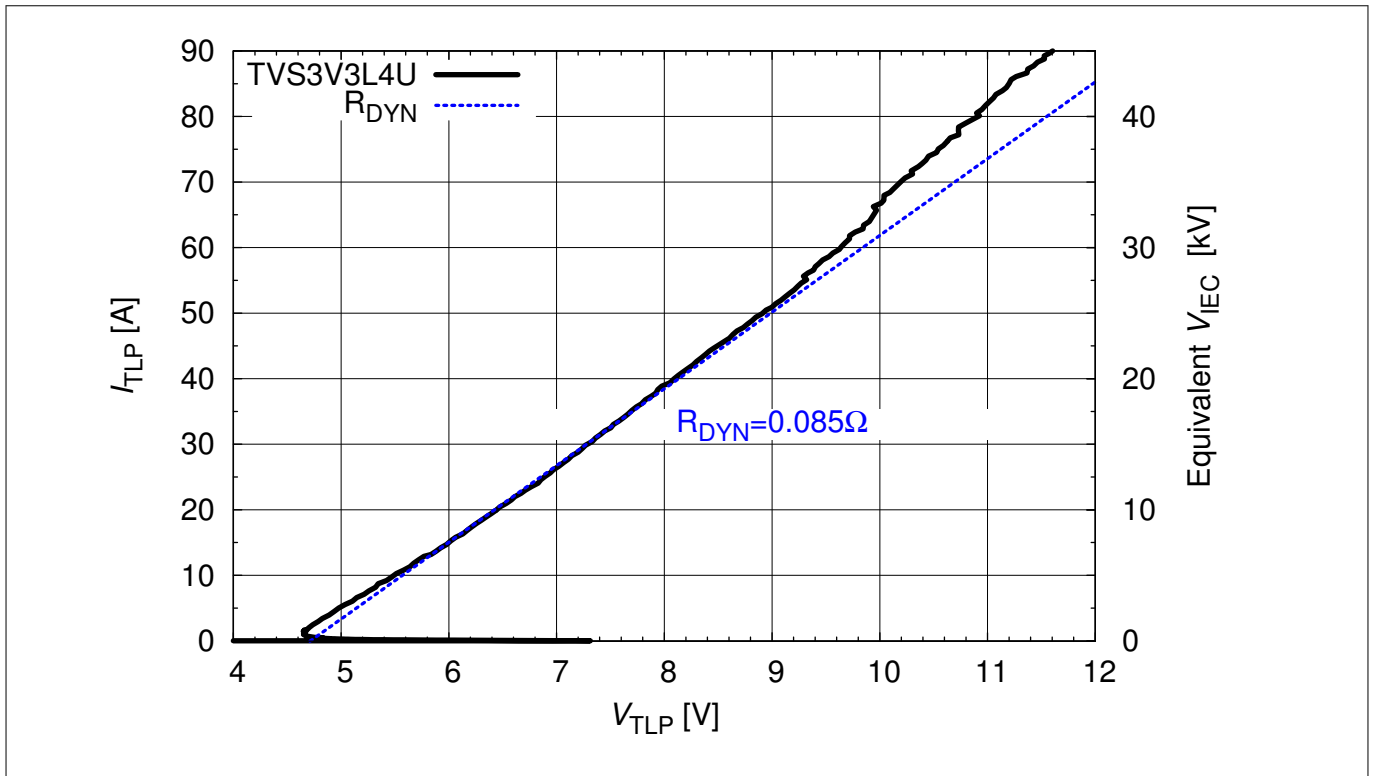

Figure 9 Clamping voltage (TLP):  $I_{TLP} = f(V_{TLP})$ , reverse pulse [1]

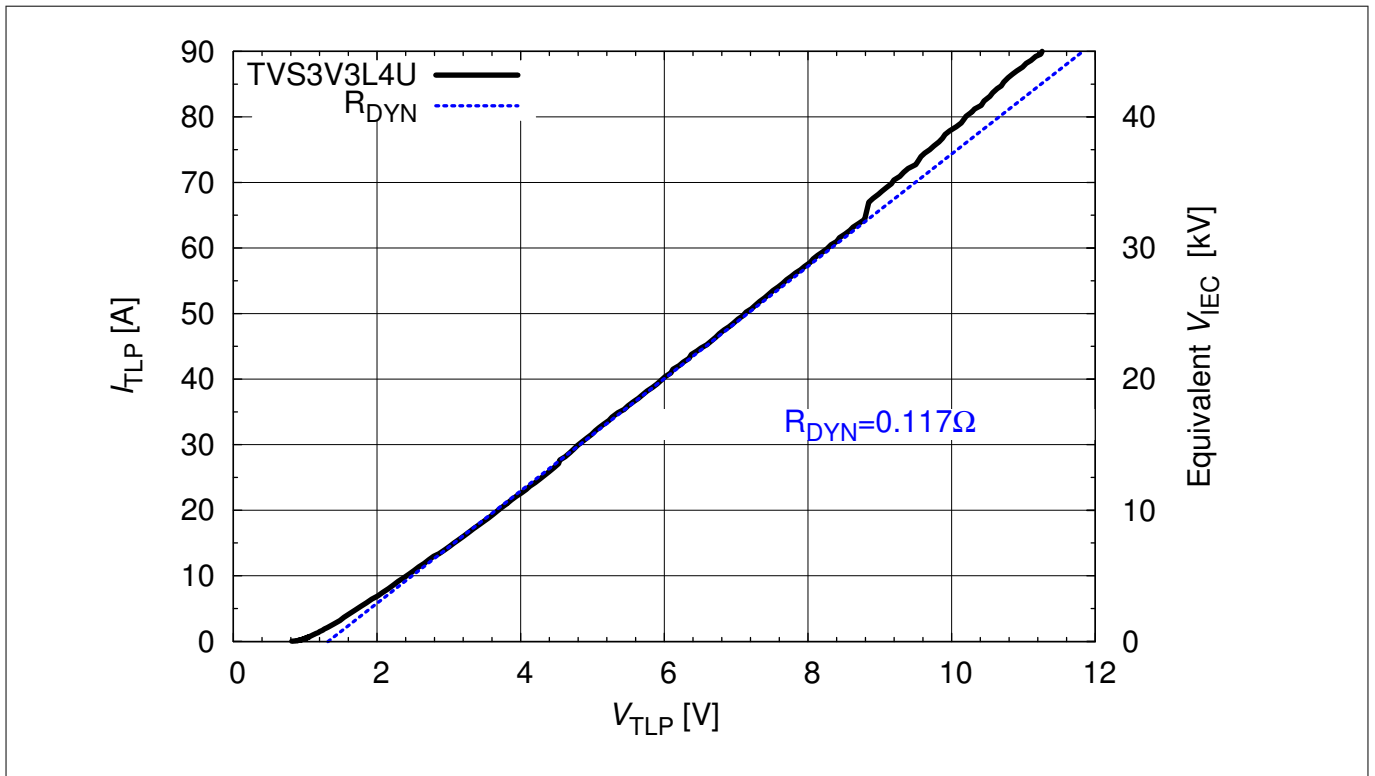
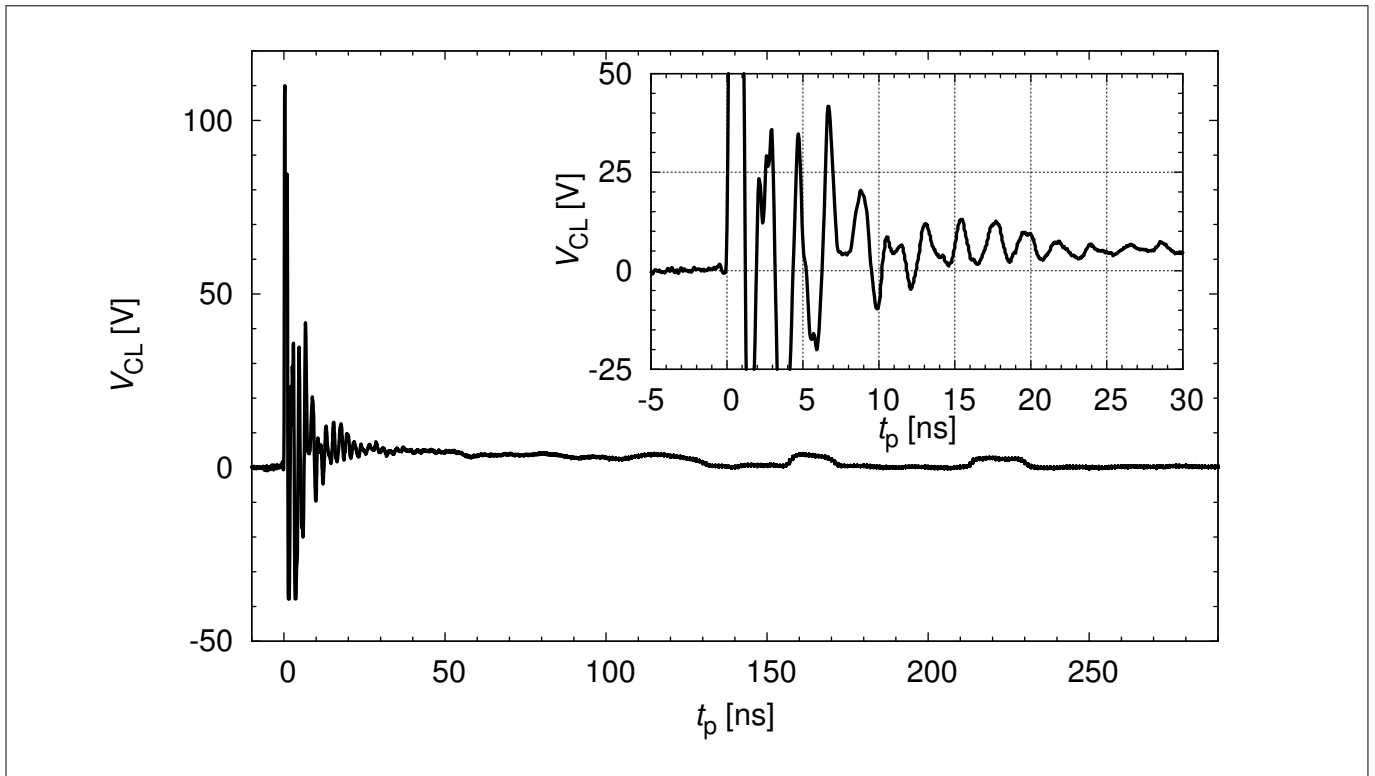
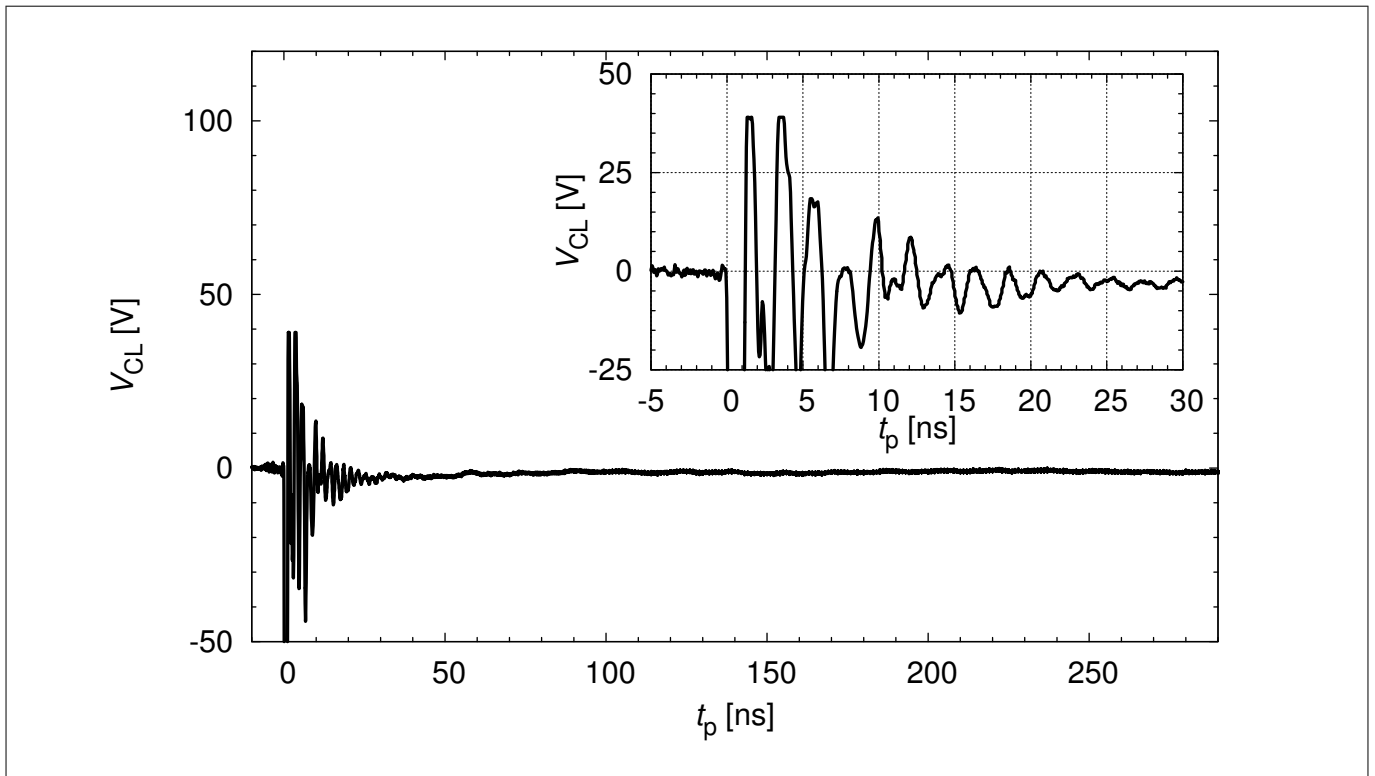

Figure 10 Clamping voltage (TLP):  $I_{TLP} = f(V_{TLP})$ , forward pulse [1]

**Typical characteristic diagrams**

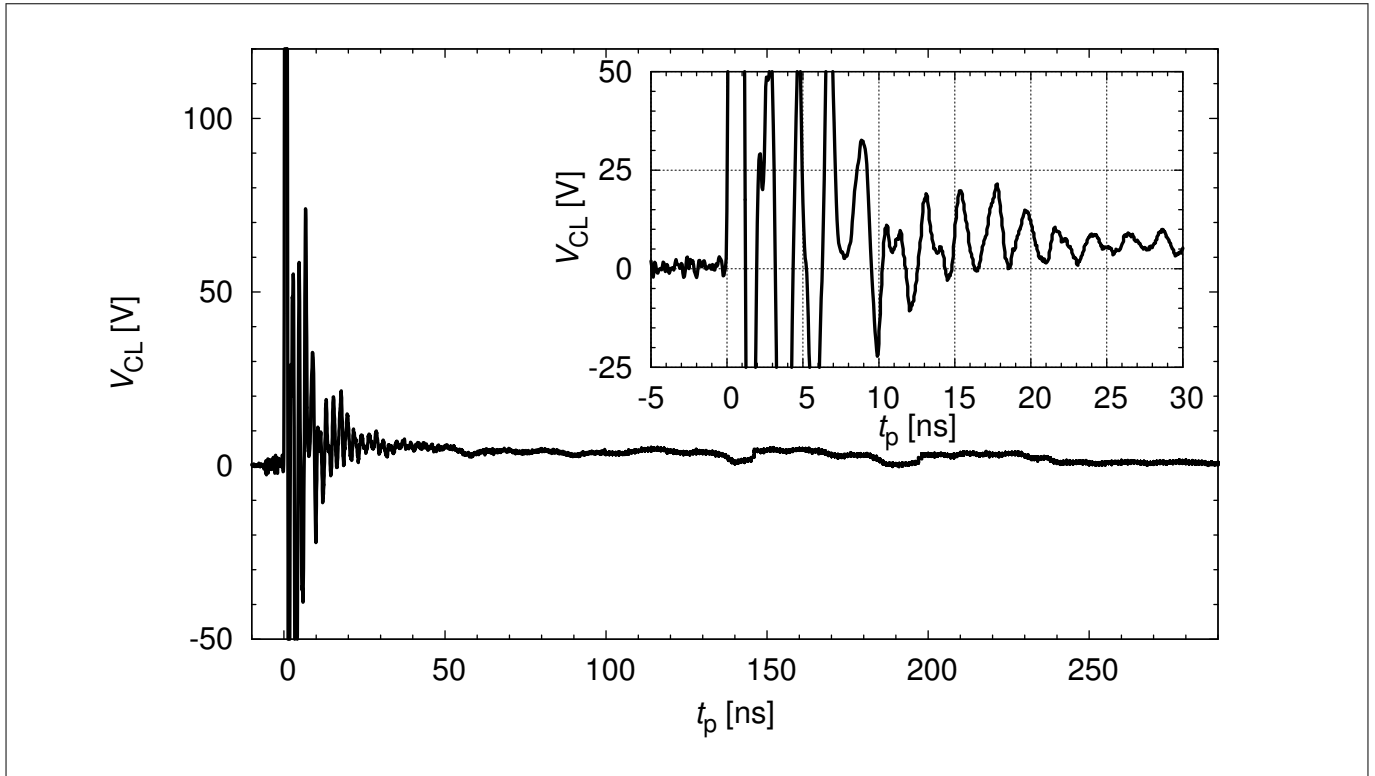

**Figure 11 Clamping voltage (ESD):  $V_{CL} = f(t)$ , 8 kV positive pulse according to IEC61000-4-2**

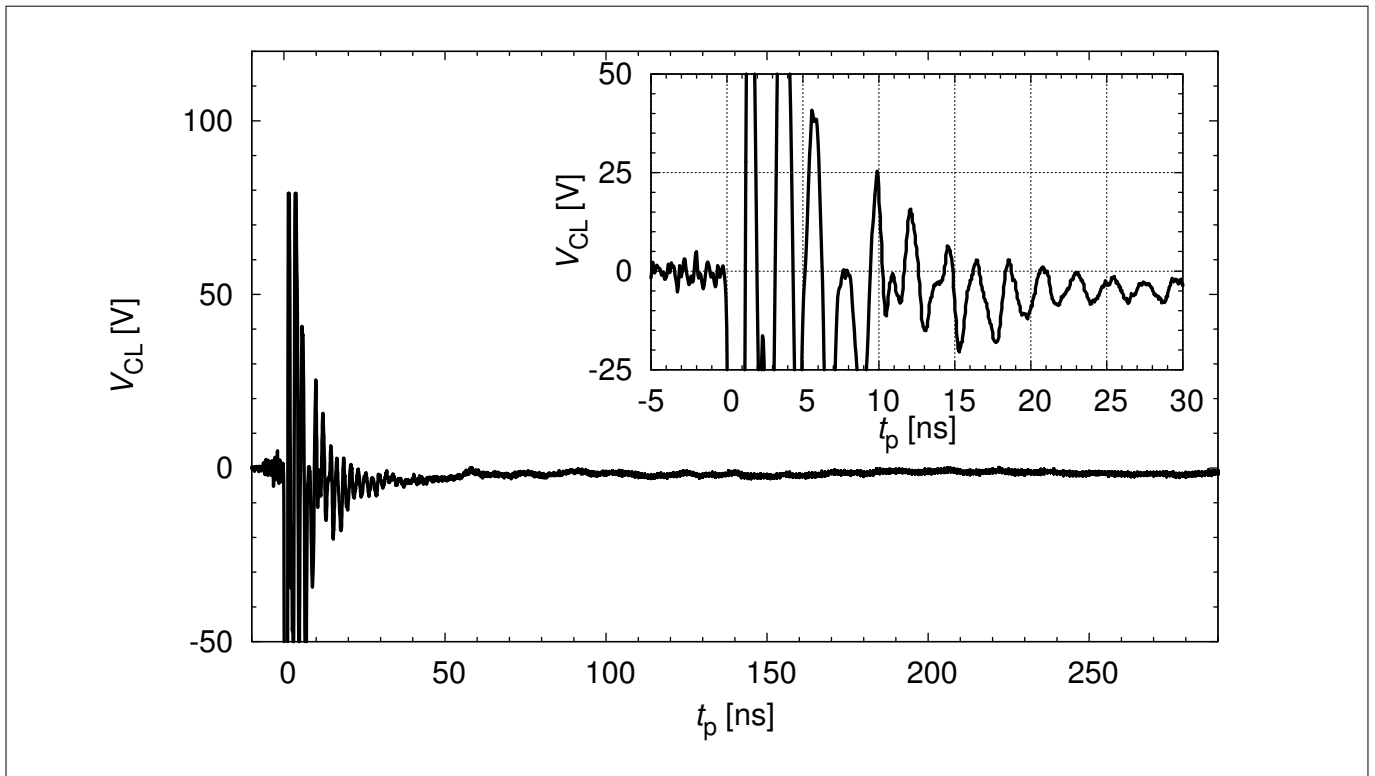

**Figure 12 Clamping voltage (ESD):  $V_{CL} = f(t)$ , -8 kV negative pulse according to IEC61000-4-2**

**Typical characteristic diagrams**



**Figure 13 Clamping voltage (ESD):  $V_{CL} = f(t)$ , +15 kV positive pulse according to IEC61000-4-2**



**Figure 14 Clamping voltage (ESD):  $V_{CL} = f(t)$ , -15 kV negative pulse according to IEC61000-4-2**

Package information

## 4 Package information

Note: Dimensions in mm.

### 4.1 SC74-6-2 package

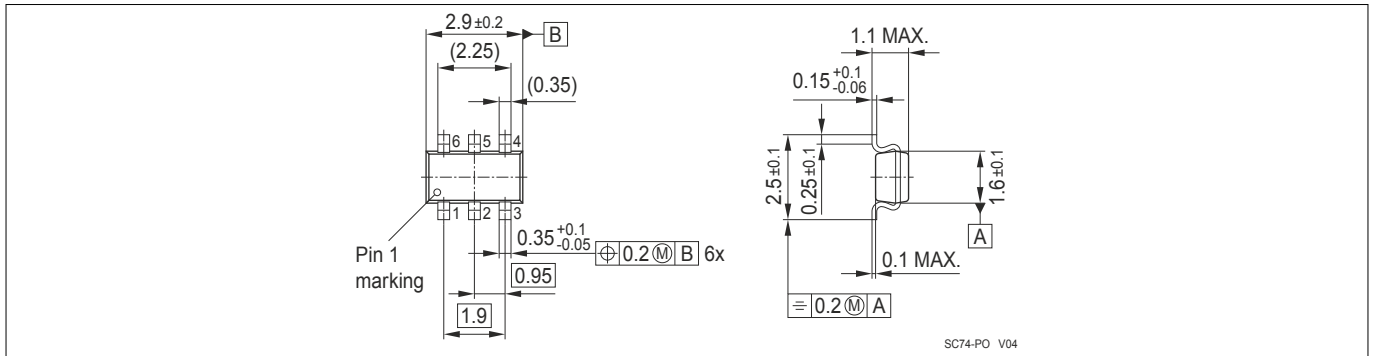

Figure 15 SC74-6-2 package outline

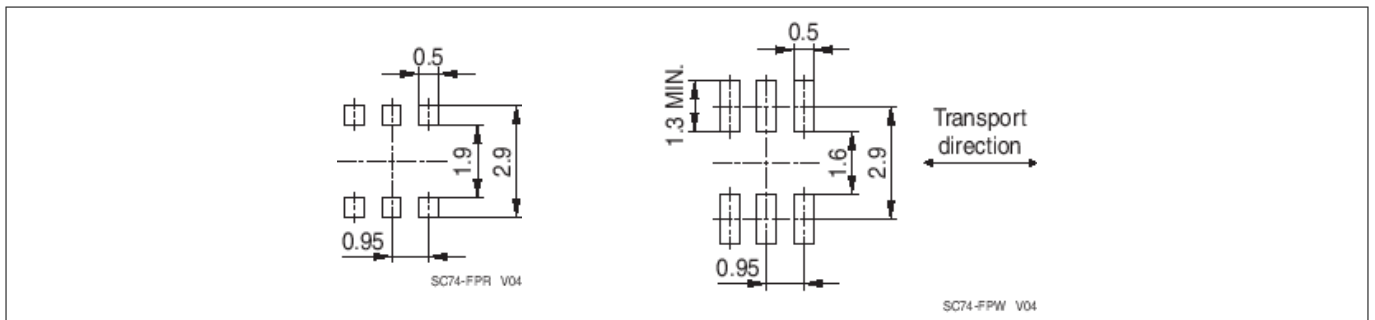

Figure 16 SC74-6-2 footprint

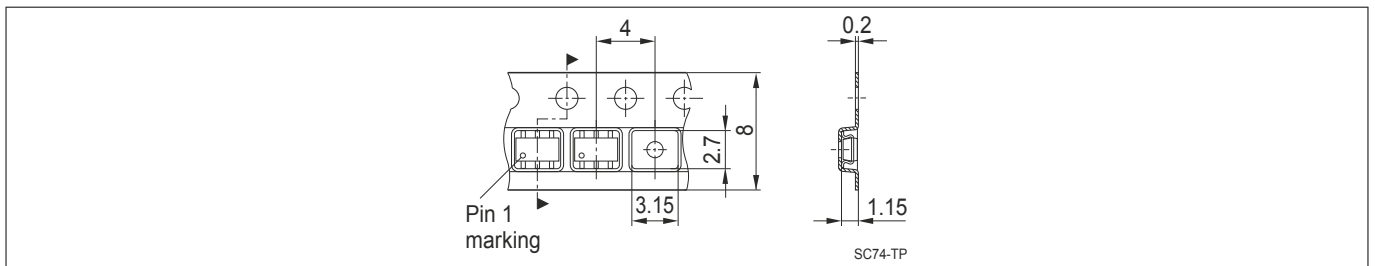

Figure 17 SC74-6-2 packing

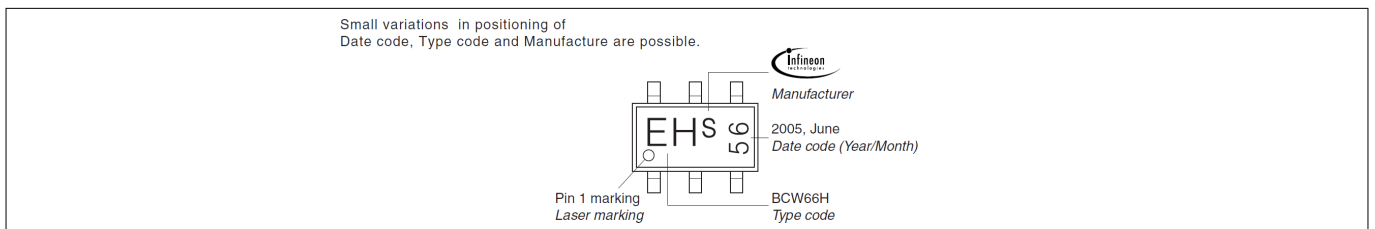

Figure 18 SC74-6-2 marking example (marking code see [Device information](#))

---

References

## 5 References

- [1] Infineon AG - **Application Note AN210**: Effective ESD protection design at system level using VF-TLP characterization methodology

## Revision history

---

**Revision history: Rev. 2.4. 2013-02-06**

Page or Item	Subjects (major changes since previous revision)
Revision 2.5, 2018-02-16	
All	Data sheet layout changed, editorial changes, references updated

## Trademarks

All referenced product or service names and trademarks are the property of their respective owners.

**Edition 2018-02-16**

**Published by**  
**Infineon Technologies AG**  
**81726 Munich, Germany**

**© 2018 Infineon Technologies AG**  
**All Rights Reserved.**

**Do you have a question about any**  
**aspect of this document?**  
**Email: [erratum@infineon.com](mailto:erratum@infineon.com)**

**Document reference**  
**IFX-rza1515758558601**

## IMPORTANT NOTICE

The information given in this document shall in no event be regarded as a guarantee of conditions or characteristics ("Beschaffheitsgarantie").

With respect to any examples, hints or any typical values stated herein and/or any information regarding the application of the product, Infineon Technologies hereby disclaims any and all warranties and liabilities of any kind, including without limitation warranties of non-infringement of intellectual property rights of any third party.

In addition, any information given in this document is subject to customer's compliance with its obligations stated in this document and any applicable legal requirements, norms and standards concerning customer's products and any use of the product of Infineon Technologies in customer's applications.

The data contained in this document is exclusively intended for technically trained staff. It is the responsibility of customer's technical departments to evaluate the suitability of the product for the intended application and the completeness of the product information given in this document with respect to such application.

## WARNINGS

Due to technical requirements products may contain dangerous substances. For information on the types in question please contact your nearest Infineon Technologies office.

Except as otherwise explicitly approved by Infineon Technologies in a written document signed by authorized representatives of Infineon Technologies, Infineon Technologies' products may not be used in any applications where a failure of the product or any consequences of the use thereof can reasonably be expected to result in personal injury