

REVISIONS						
PAGE	ZONE	REV	ECN	DESCRIPTION	DATE	APPROVED
-	-	**	2692761	NEW RELEASE	04/17/09	
ALL	-	*A	3598936	UPDATED DRAWING BASED ON SUPPLIER'S LATEST DRAWING REVISION CHANGE TEMPLATE	04/25/12	QAD/UYO/AVC

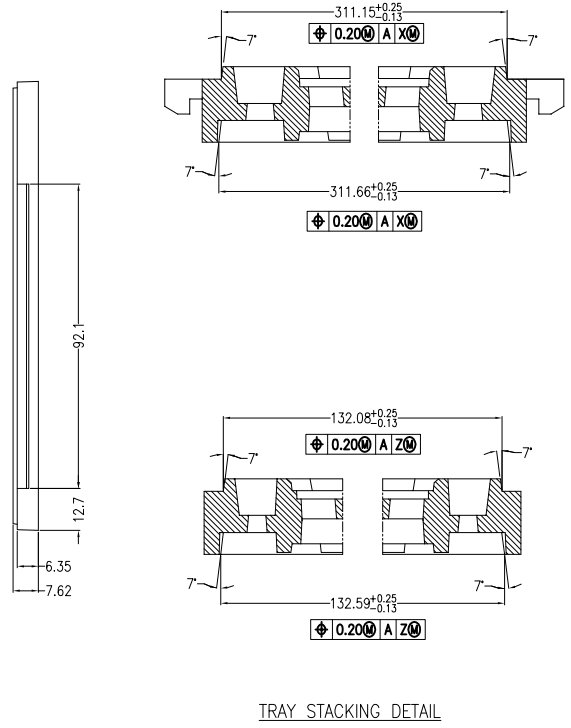

TRAY STACKING DETAIL

13mmx15mm FBGA 8x17
KS - 88146 REV 01

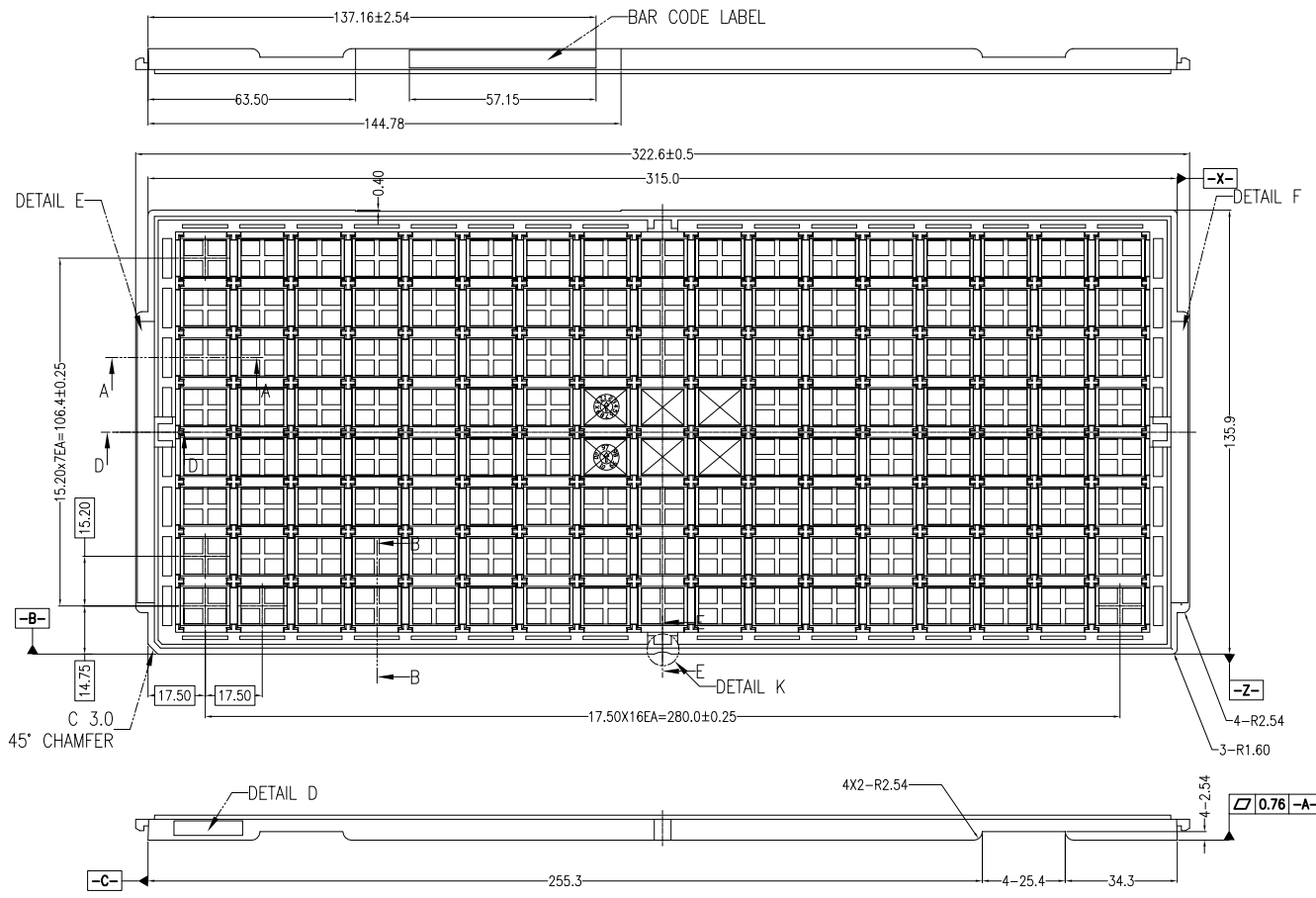
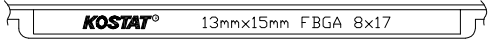

DETAIL D
SCALE 2/1

DETAIL E
SCALE 2/1

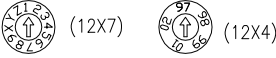

DATE DETAIL
SCALE 2/1



DETAIL F
SCALE 2/1

DESCRIPTION	MATERIAL	COLOR	TEMP °C	E S D
NON-BAKEABLE	ABS	BLUE,RED	50°C	10 ¹⁰ TO 10 ¹² ohms/SQ.
BAKEABLE	KS-6120	BLACK	140°C	10 ⁶ TO 10 ¹¹ ohms/SQ.
BAKEABLE	KS-6110	BLACK	150°C	10 ⁶ TO 10 ¹¹ ohms/SQ.
BAKEABLE	KS-6100	BLACK	180°C	10 ⁶ TO 10 ¹¹ ohms/SQ.

*SUPPLIER P/N: KS-88146

UNLESS OTHERWISE SPECIFIED ALL DIMENSIONS ARE IN MILLIMETERS STANDARD TOLERANCES ON: DECIMALS .X ± 0.25 .XX ± 0.13 .XXX ± 0.13 ANGLES ± 1°	DESIGNED BY	DATE
	DRAWN BY AQJ	DATE 04/25/12
	CHECKED BY AVC	DATE 04/25/12
	APPROVED BY QAD	DATE 04/25/12
MATERIAL SEE NOTES	APPROVED BY UYO	DATE 04/25/12
FINISH	APPROVED BY	DATE



TITLE
TRAY, FBGA 15X13 MM (KOSTAT)

SIZE A	PART NO. TBB15131.4J-*	DWG NO 001-52948	REV *A
SCALED TO FIT	ENG'G REV	SHEET 1 OF 2	

THIS DRAWING CONTAINS INFORMATION WHICH IS THE PROPRIETARY PROPERTY OF CYPRESS SEMICONDUCTOR CORPORATION. THIS DRAWING IS RECEIVED IN CONFIDENCE AND ITS CONTENTS MAY NOT BE DISCLOSED WITHOUT WRITTEN CONSENT OF CYPRESS SEMICONDUCTOR CORPORATION.

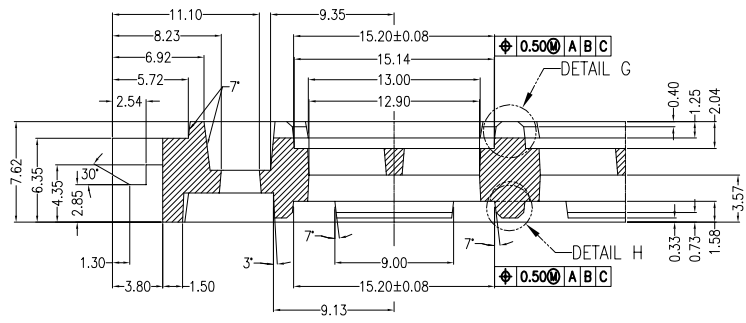

SECTION A-A
SCALE 4/1

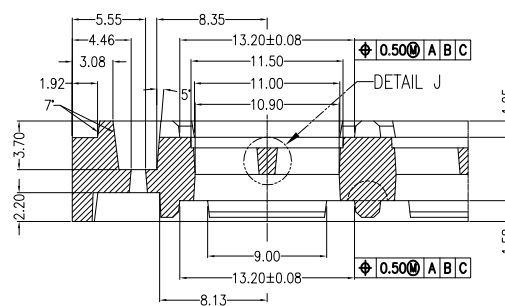

SECTION B-B
SCALE 4/1

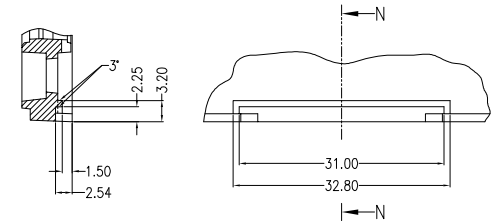

SECTION N-N
SCALE 4/1

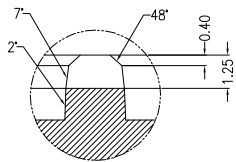

DETAIL G
SCALE 8/1

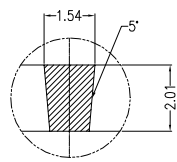

DETAIL J
SCALE 10/1

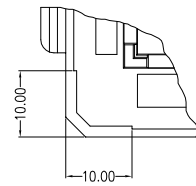

STACKING DETAIL
SCALE 2/1

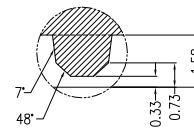

DETAIL H
SCALE 10/1

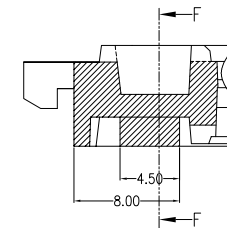

SECTION D-D
SCALE 4/1

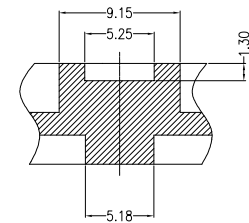

SECTION F-F
SCALE 4/1

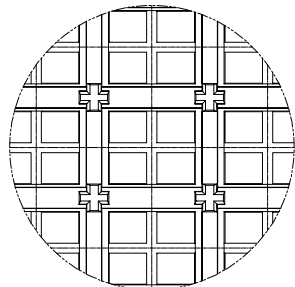

TOP VIEW
SCALE 2/1

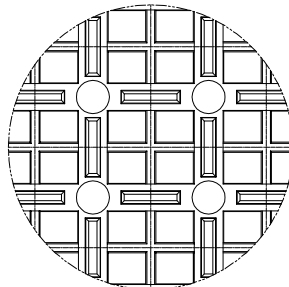

BOTTOM VIEW
SCALE 2/1

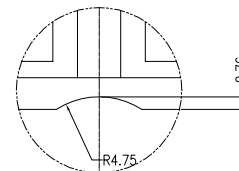

DETAIL K
SCALE 4/1

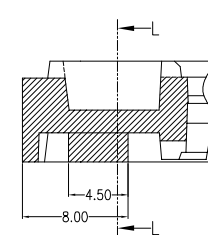

SECTION E-E
SCALE 4/1

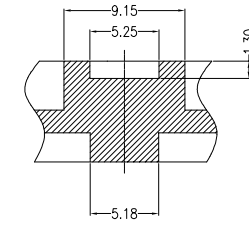

SECTION L-L
SCALE 4/1

THIS DRAWING CONTAINS INFORMATION WHICH IS THE PROPRIETARY PROPERTY OF CYPRESS SEMICONDUCTOR CORPORATION. THIS DRAWING IS RECEIVED IN CONFIDENCE AND ITS CONTENTS MAY NOT BE DISCLOSED WITHOUT WRITTEN CONSENT OF CYPRESS SEMICONDUCTOR CORPORATION.

 CYPRESS Company Confidential			
TITLE TRAY, FBGA 15X13 MM (KOSTAT)			
SIZE A	PART NO. TBB15131.4J-*	DWG NO 001-52948	REV *A
SCALED TO FIT		ENG'G REV	SHEET 2 OF 2