

OPTIREG™ linear TLS850B0TEV50

Low dropout linear voltage regulator



Features

- Wide input voltage range from 3.0 V to 40 V
- Fixed output voltage 5 V
- Output voltage accuracy $\leq \pm 2\%$
- Output current capability up to 500 mA
- Ultra low current consumption, typical 20 μ A
- Very low dropout voltage, typical 100 mV at 100 mA
- Stable with ceramic output capacitor of 1 μ F
- Enable function
- Overtemperature shutdown
- Output current limitation
- Wide temperature range
- Green Product (RoHS-compliant)

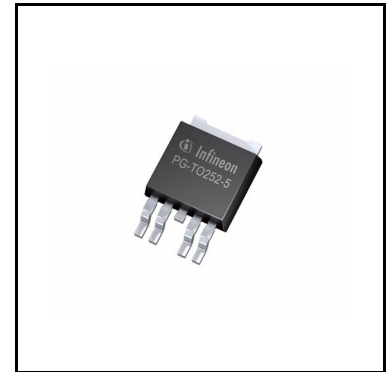

Potential applications

- Automotive or other supply systems that are connected to the battery permanently
- Automotive supply systems that need to operate in cranking condition

Product validation

Qualified for automotive applications. Product validation according to AEC-Q100.

Description

The OPTIREG™ linear TLS850B0TEV50 is a high performance, very low dropout linear voltage regulator for 5 V supply in a PG-TO252-5 package.

The input voltage range of 3 V to 40 V and a very low quiescent current of 20 μ A make it the perfect match for automotive or other supply systems connected to the battery permanently.

The new loop concept combines fast regulation and very high stability. Below an output current of 100 mA, the typical dropout voltage is below 100 mV. The operating range starts at an input voltage of only 3 V (extended operating range). This makes the TLS850B0TEV50 suitable for automotive systems that need to operate during cranking condition.

The device can be switched on and off by the enable feature.

Internal protection features such as output current limitation and overtemperature shutdown protect the device from immediate damage due to failures such as output shorted to GND, overcurrent, and overtemperature.

Choosing external components

An input capacitor C_i is recommended to compensate line influences.

The output capacitor C_o is necessary for the stability of the regulating circuit. TLS850B0TEV50 is designed to operate stable with low-ESR ceramic capacitors.

Type	Package	Marking
TLS850B0TEV50	PG-TO252-5	850B0V50

Table of contents

	Features	1
	Potential applications	1
	Product validation	1
	Description	1
	Choosing external components	2
	Table of contents	3
1	Block diagram	4
2	Pin configuration	5
2.1	Pin assignment	5
2.2	Pin definitions and functions	5
3	General product characteristics	6
3.1	Absolute maximum ratings	6
3.2	Functional range	7
3.3	Thermal resistance	8
4	Block description and electrical characteristics	9
4.1	Voltage regulation	9
4.2	Typical performance characteristics: voltage regulator	12
4.3	Current consumption	14
4.4	Typical performance characteristics: current consumption	15
4.5	Enable function	17
4.6	Typical performance characteristics: enable function	18
5	Application information	19
5.1	Application diagram	19
5.2	Selection of external components	19
5.2.1	Input pin	19
5.2.2	Output pin	19
5.3	Thermal considerations	20
5.4	Reverse-polarity protection	20
5.5	Further application information	20
6	Package outlines	21
7	Revision history	22

Block diagram

1 Block diagram

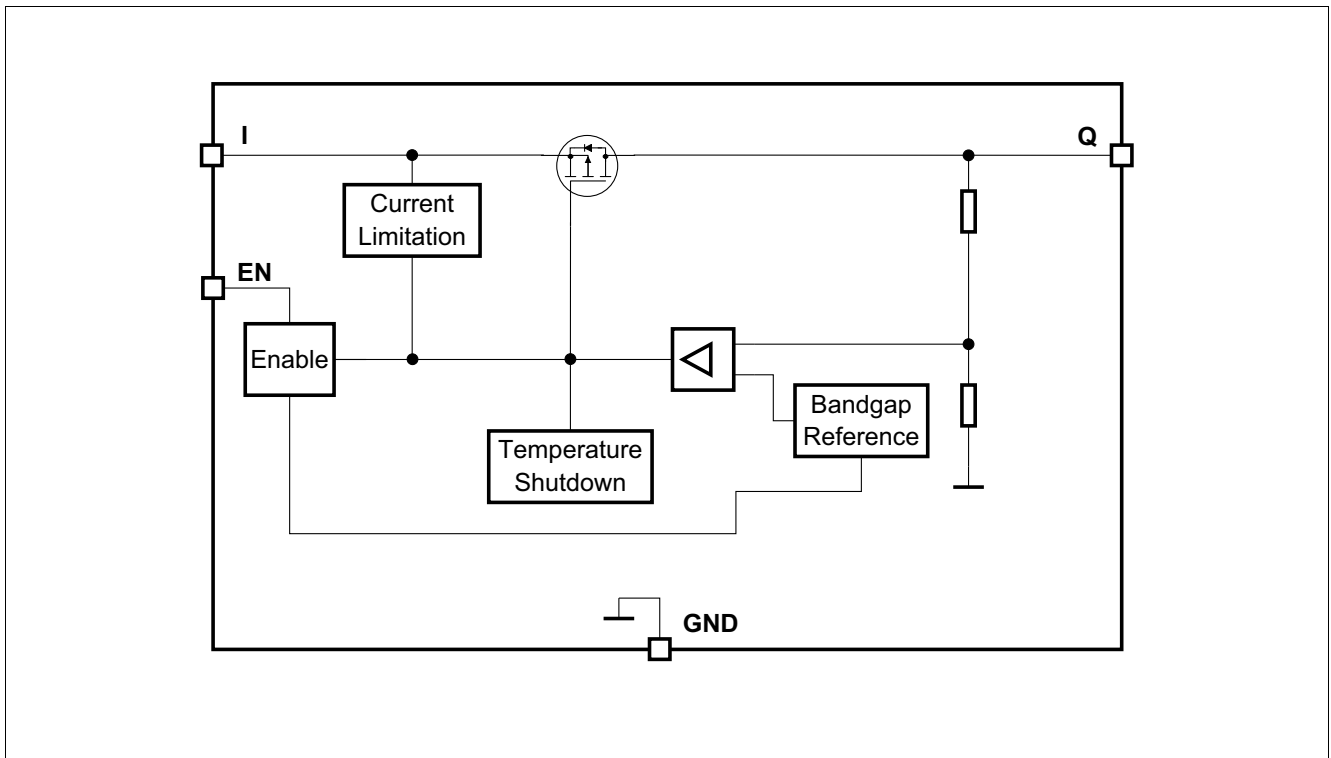

Figure 1 Block diagram

Pin configuration

2 Pin configuration

2.1 Pin assignment

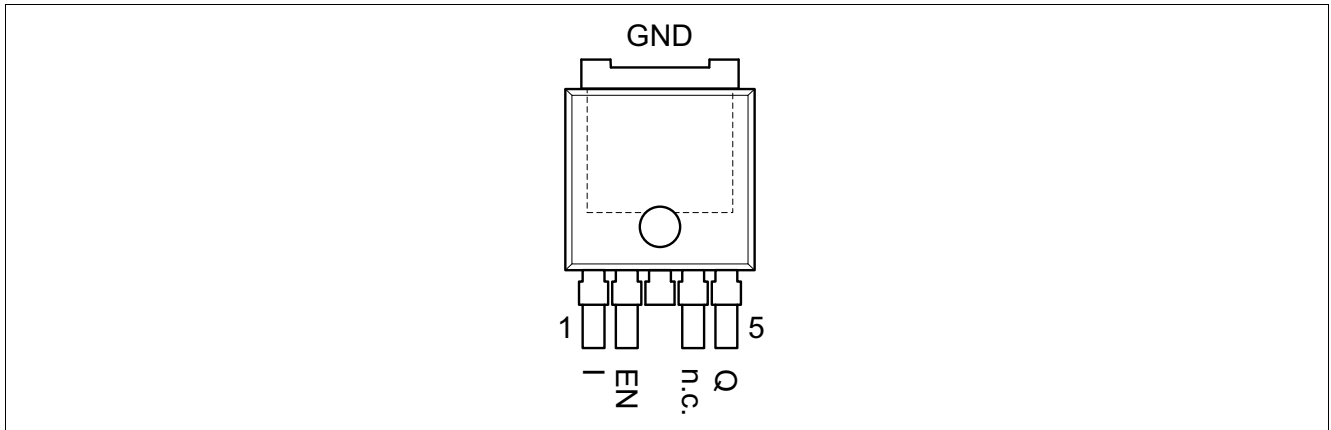

Figure 2 Pin configuration

2.2 Pin definitions and functions

Table 1 Pin definitions and functions

Pin	Symbol	Function
1	I	Input It is recommended to place a small ceramic capacitor (for example, 100 nF) to GND, close to the pins, in order to compensate line influences
2	EN	Enable (integrated pull-down resistor) Enable the IC with high level input signal Disable the IC with low level input signal
3	GND	Ground
4	n.c.	Not connected Leave open or connect to GND
5	Q	Output Connect output capacitor C_Q to GND close to the pin, respecting the values specified for its capacitance and ESR in Functional range
Heat slug	GND	Heat slug Connect to GND Connect to heatsink area

General product characteristics

3 General product characteristics

3.1 Absolute maximum ratings

Table 2 Absolute maximum ratings¹⁾

$T_j = -40^{\circ}\text{C}$ to $+150^{\circ}\text{C}$; all voltages with respect to ground (unless otherwise specified)

Parameter	Symbol	Values			Unit	Note or Test Condition	Number
		Min.	Typ.	Max.			
Input I, Enable EN							
Voltage	V_I, V_{EN}	-0.3	–	45	V	–	P_4.1.1
Output Q							
Voltage	V_Q	-0.3	–	7	V	–	P_4.1.2
Temperatures							
Junction temperature	T_j	-40	–	150	$^{\circ}\text{C}$	–	P_4.1.3
Storage temperature	T_{stg}	-55	–	150	$^{\circ}\text{C}$	–	P_4.1.4
ESD susceptibility							
ESD susceptibility to GND	V_{ESD}	-2	–	2	kV	²⁾ Human body model (HBM)	P_4.1.5
ESD susceptibility to GND	V_{ESD}	-500	–	500	V	³⁾ Charged device model (CDM)	P_4.1.6
ESD susceptibility of corner pins to GND	$V_{ESD1,5}$	-750	–	750	V	³⁾ Charged device model (CDM)	P_4.1.7

1) Not subject to production test, specified by design.

2) ESD susceptibility, HBM according to ANSI/ESDA/JEDEC JS001 (1.5 k Ω , 100 pF).

3) ESD susceptibility, charged device model (CDM) according to JEDEC JESD22-C101.

Notes

1. Stresses above the ones listed here may cause permanent damage to the device. Exposure to absolute maximum rating conditions for extended periods may affect device reliability.
2. Integrated protection functions are designed to prevent device destruction under fault conditions described in the datasheet. Fault conditions are considered as “outside” normal operating range. Protection functions are not designed for continuous repetitive operation.

General product characteristics

3.2 Functional range

Table 3 Functional range

$T_j = -40^\circ\text{C}$ to $+150^\circ\text{C}$; all voltages with respect to ground (unless otherwise specified)

Parameter	Symbol	Values			Unit	Note or Test Condition	Number
		Min.	Typ.	Max.			
Input voltage range	V_I	$V_{Q,nom} + V_{dr}$	–	40	V	¹⁾ –	P_4.2.1
Extended input voltage range	$V_{I,ext}$	3.0	–	40	V	²⁾ –	P_4.2.2
Enable voltage range	V_{EN}	0	–	40	V	–	P_4.2.3
Output capacitor's requirements for stability	C_Q	1	–	–	μF	³⁾⁴⁾ –	P_4.2.4
ESR of output capacitor	$ESR(C_Q)$	–	–	50	Ω	³⁾ –	P_4.2.5
ESR of output capacitor	$ESR(C_Q)$	–	–	100	Ω	³⁾ $V_{IN} < 25\text{ V}$	P_4.2.5
Junction temperature	T_j	-40	–	150	$^\circ\text{C}$	–	P_4.2.6

1) Output current is limited internally and depends on the input voltage. See Electrical Characteristics for more details.

2) If $V_{I,ext,min} \leq V_I \leq V_{Q,nom} + V_{dr}$, then $V_Q = V_I - V_{dr}$. If $V_I < V_{I,ext,min}$, then V_Q can drop to 0 V.

3) Not subject to production test, specified by design.

4) The minimum output capacitance requirement is applicable for a worst-case capacitance tolerance of 30%.

Note: Within the functional or operating range, the device operates as described in the circuit description. The electrical characteristics are specified within the conditions given in the Electrical Characteristics table.

General product characteristics

3.3 Thermal resistance

Note: This thermal data was generated in accordance with JEDEC JESD51 standards. For more information, go to www.jedec.org.

Table 4 Thermal resistance ¹⁾

Parameter	Symbol	Values			Unit	Note or Test Condition	Number
		Min.	Typ.	Max.			
Junction to case	R_{thJC}	–	3.1	–	K/W	–	P_4.3.6
Junction to ambient	R_{thJA}	–	26	–	K/W	²⁾ 2s2p board	P_4.3.7
Junction to ambient	R_{thJA}	–	85	–	K/W	³⁾ 1s0p board, footprint only	P_4.3.8
Junction to ambient	R_{thJA}	–	43	–	K/W	³⁾ 1s0p board, 300 mm ² heatsink area on PCB	P_4.3.9
Junction to ambient	R_{thJA}	–	36	–	K/W	³⁾ 1s0p board, 600 mm ² heatsink area on PCB	P_4.3.10

1) Not subject to production test, specified by design.

2) The specified R_{thJA} value is according to JEDEC JESD51-2,-5,-7 at natural convection on an FR4 2s2p board. The product (chip and package) was simulated on a 76.2 × 114.3 × 1.5 mm³ board with two inner copper layers (2 × 70 μm Cu, 2 × 35 μm Cu). Where applicable, a thermal via array under the exposed pad contacted the first inner copper layer.

3) The specified R_{thJA} value is according to JEDEC JESD 51-3 at natural convection on an FR4 1s0p board. The product (chip and package) was simulated on a 76.2 × 114.3 × 1.5 mm³ board with one copper layer (1 × 70 μm Cu).

4 Block description and electrical characteristics

4.1 Voltage regulation

The output voltage V_Q is divided by a resistor network. This fractional voltage is compared to an internal voltage reference and the pass transistor is driven accordingly.

The control loop stability depends on the following factors:

- Output capacitor C_Q
- Load current
- Chip temperature T_j
- Internal circuit design

To ensure stable operation, the output capacitor's capacitance and its equivalent series resistor $ESR(C_Q)$ requirements given in **Table 3** must be maintained. Because the output capacitor must buffer load steps, it must be sized according to the requirements of the application.

An input capacitor C_I is recommended to compensate line influences. In order to block influences such as pulses and high frequency distortion at the input, an additional reverse-polarity protection diode and a combination of several capacitors for filtering should be used. Connect the capacitors close to the component's terminals.

In order to prevent overshoots during start-up, a slope-control function is implemented. This significantly reduces output voltage overshoots during start-up, mostly independent from the load.

If the load current exceeds the specified limit, for example, due to a short circuit, then the device limits the output current, and the output voltage decreases.

The overtemperature shutdown circuit prevents the device from immediate destruction in fault condition, for example, due to a permanent short-circuit at the output, by switching off the power stage. After the chip has cooled down, the regulator restarts. This leads to an oscillatory behavior of the output voltage until the fault is removed. However, any junction temperature above 150°C is outside the maximum ratings and therefore significantly reduces the lifetime of the device.

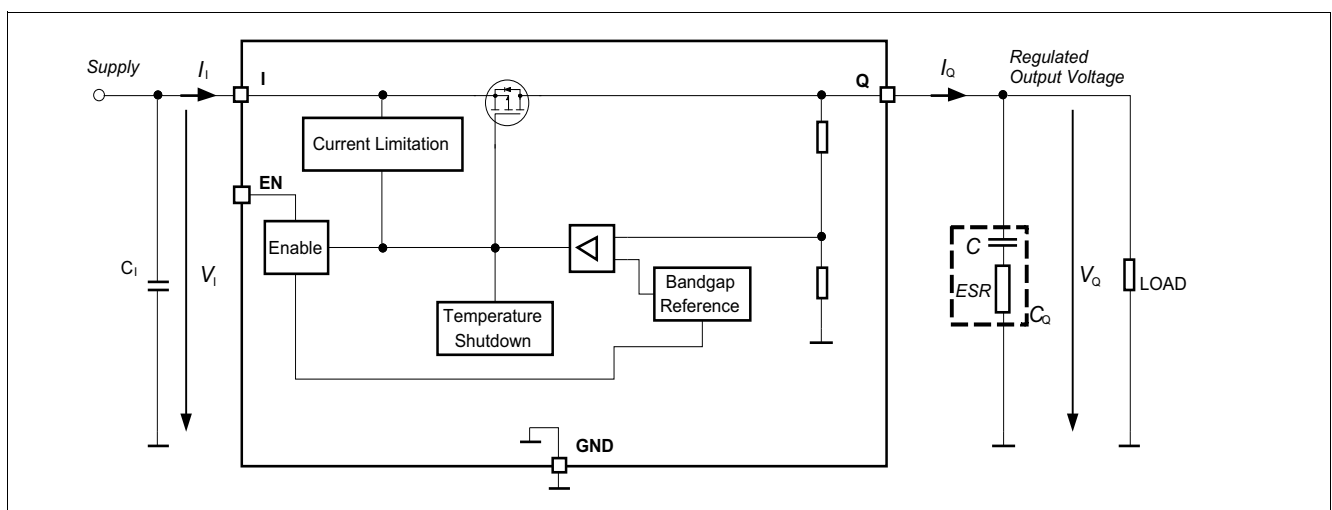

Figure 3 Block diagram: voltage regulation

Block description and electrical characteristics

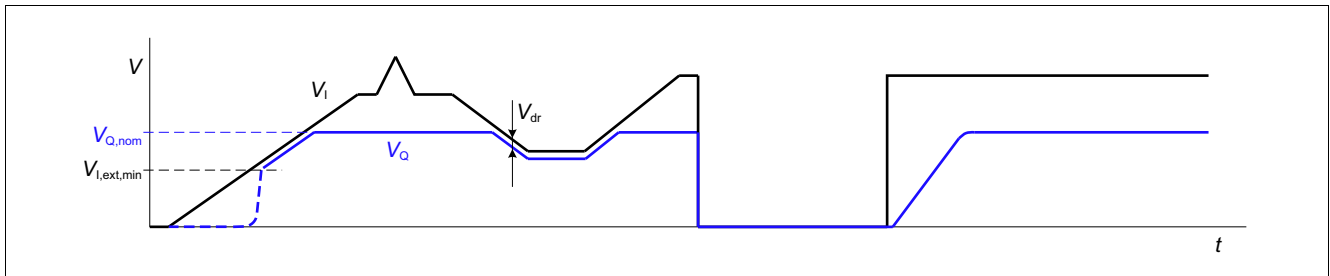

Figure 4 Output voltage versus input voltage

Block description and electrical characteristics

Table 5 Electrical characteristics: voltage regulator

$T_j = -40^\circ\text{C}$ to $+150^\circ\text{C}$, $V_I = 13.5\text{ V}$, all voltages with respect to ground (unless otherwise specified)

Typical values are given at $T_j = 25^\circ\text{C}$

Parameter	Symbol	Values			Unit	Note or Test Condition	Number
		Min.	Typ.	Max.			
Output voltage accuracy	V_Q	4.9	5.0	5.1	V	$0.05\text{ mA} < I_Q < 500\text{ mA}$ $6.1\text{ V} < V_I < 28\text{ V}$	P_5.1.1
Output voltage accuracy	V_Q	4.9	5.0	5.1	V	$0.05\text{ mA} < I_Q < 200\text{ mA}$ $5.5\text{ V} < V_I < 40\text{ V}$	P_5.1.2
Output voltage startup slew rate	dV_Q/dt	3.0	35	85	V/ms	$V_I > 18\text{ V/ms}$ $C_Q = 1\ \mu\text{F}$ $0.5\text{ V} < V_Q < 4.5\text{ V}$	P_5.1.9
Output current limitation	$I_{Q,max}$	501	750	1100	mA	$0\text{ V} < V_Q < V_{Q,nom} - 0.1\text{ V}$	P_5.1.10
Load regulation steady state	$\Delta V_{Q,load}$	-15	-5	-	mV	$I_Q = 0.05\text{ mA}$ to 500 mA $V_I = 6.5\text{ V}$	P_5.1.12
Line regulation steady state	$\Delta V_{Q,line}$	-	1	10	mV	$V_I = 8\text{ V}$ to 32 V $I_Q = 5\text{ mA}$	P_5.1.13
Dropout voltage $V_{dr} = V_I - V_Q$	V_{dr}	-	250	500	mV	¹⁾ $I_Q = 250\text{ mA}$	P_5.1.14
Dropout voltage $V_{dr} = V_I - V_Q$	V_{dr}	-	100	200	mV	¹⁾ $I_Q = 100\text{ mA}$	P_5.1.15
Power supply ripple rejection	$PSRR$	-	60	-	dB	²⁾ $f_{ripple} = 100\text{ Hz}$ $V_{ripple} = 0.5\text{ Vpp}$	P_5.1.16
Overtemperature shutdown threshold	$T_{j,sd}$	151	-	200	$^\circ\text{C}$	²⁾ T_j increasing	P_5.1.17
Overtemperature shutdown threshold hysteresis	$T_{j,sdh}$	-	15	-	K	²⁾ T_j decreasing	P_5.1.18

1) Measured when the output voltage V_Q has dropped 100 mV from the nominal value obtained at $V_I = 13.5\text{ V}$.

2) Not subject to production test, specified by design.

4.2 Typical performance characteristics: voltage regulator

Output voltage V_Q versus junction temperature T_j

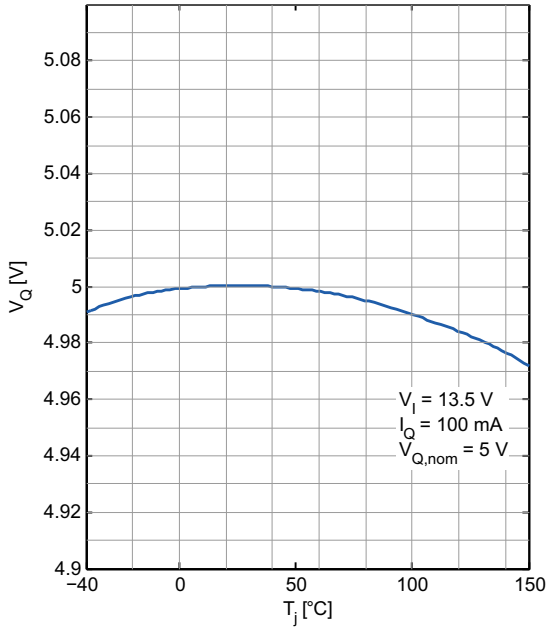

Dropout voltage V_{dr} versus output current I_Q

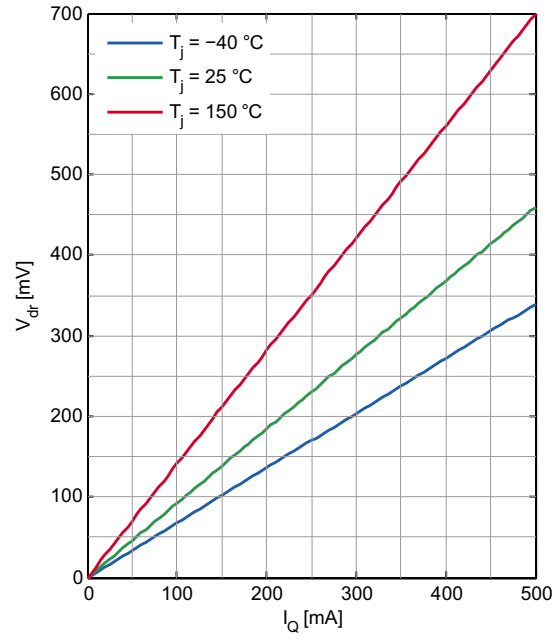

Load regulation $\Delta V_{Q,load}$ versus output current I_Q

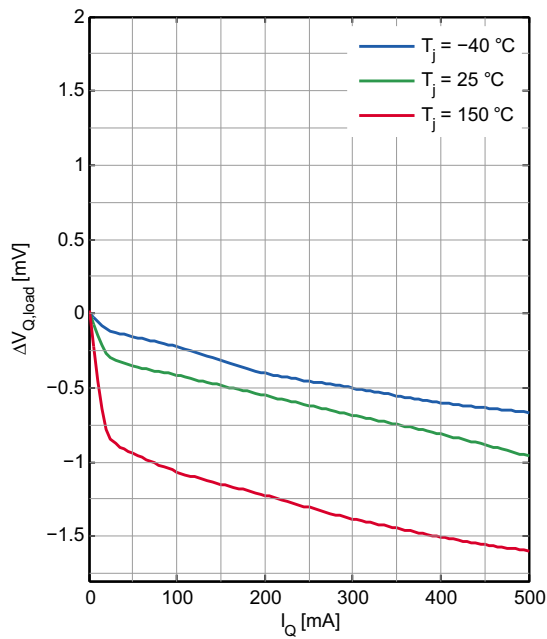

Line regulation $\Delta V_{Q,line}$ versus input voltage V_I

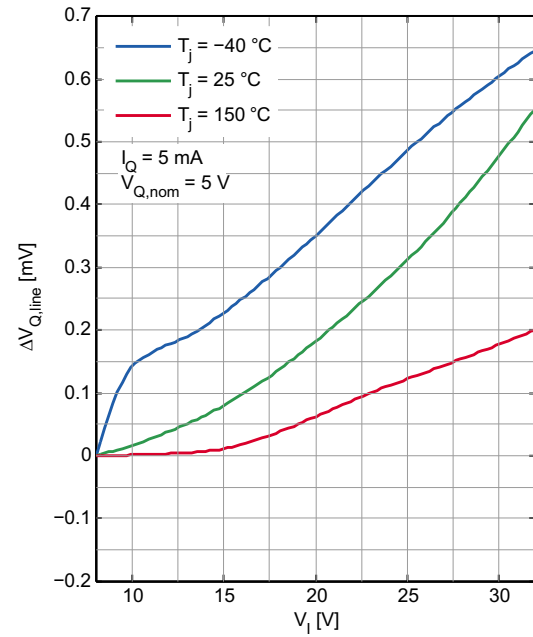

Block description and electrical characteristics

Output voltage V_Q versus input voltage V_I

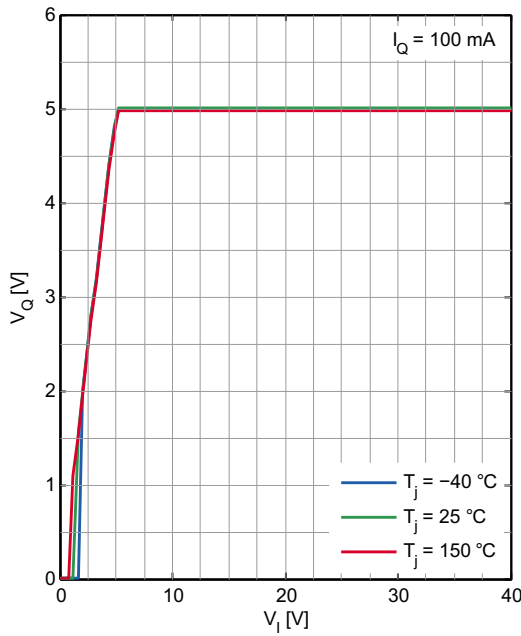

Output capacitor $ESR(C_Q)$ versus output current I_Q

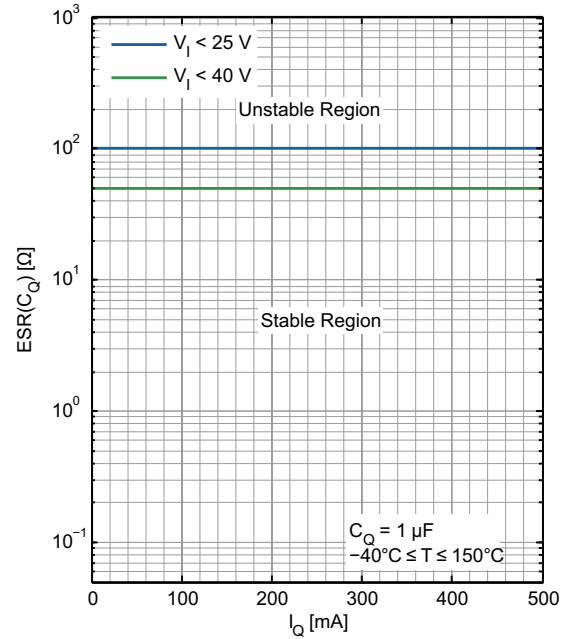

Power supply ripple rejection $PSRR$ versus ripple frequency f

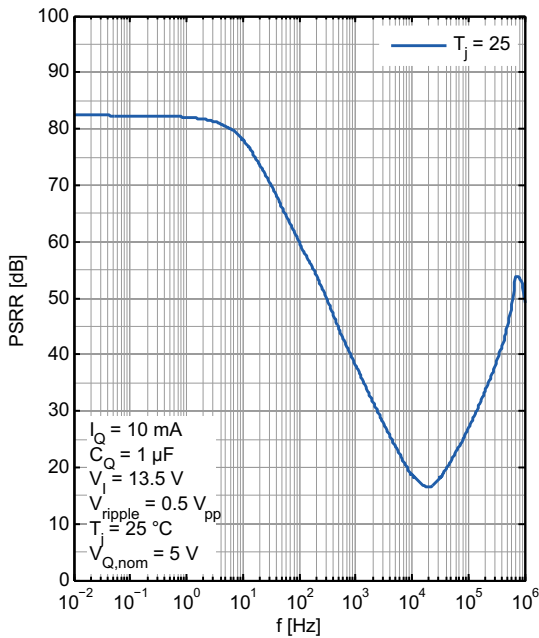

Maximum output current I_{Qmax} versus input voltage V_I

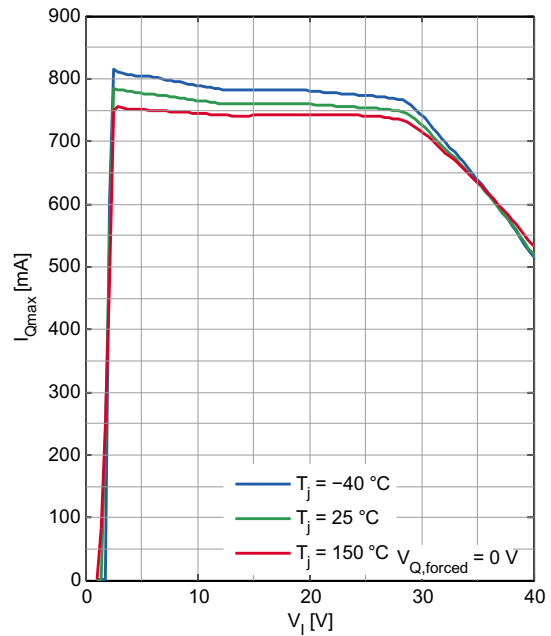

Block description and electrical characteristics

4.3 Current consumption

Table 6 Electrical characteristics: current consumption

$T_j = -40^\circ\text{C}$ to $+150^\circ\text{C}$, $V_I = 13.5\text{ V}$ (unless otherwise specified)

Typical values are given at $T_j = 25^\circ\text{C}$

Parameter	Symbol	Values			Unit	Note or Test Condition	Number
		Min.	Typ.	Max.			
Current consumption $I_q = I_1$	$I_{q,off}$	–	–	1	μA	$V_{EN} = 0\text{ V}; T_j < 105^\circ\text{C}$	P_5.3.1
Current consumption $I_q = I_1$	$I_{q,off}$	–	–	2	μA	$V_{EN} = 0.4\text{ V}; T_j < 125^\circ\text{C}$	P_5.3.3
Current consumption $I_q = I_1 - I_Q$	I_q	–	20	25	μA	$I_Q = 0.05\text{ mA}$ $T_j = 25^\circ\text{C}$	P_5.3.4
Current consumption $I_q = I_1 - I_Q$	I_q	–	23	30	μA	$I_Q = 0.05\text{ mA}$ $T_j < 125^\circ\text{C}$	P_5.3.5
Current consumption $I_q = I_1 - I_Q$	I_q	–	25	33	μA	¹⁾ $I_Q = 500\text{ mA}$ $T_j < 125^\circ\text{C}$	P_5.3.6

1) Not subject to production test, specified by design.

4.4 Typical performance characteristics: current consumption

Current consumption I_q versus output current I_Q

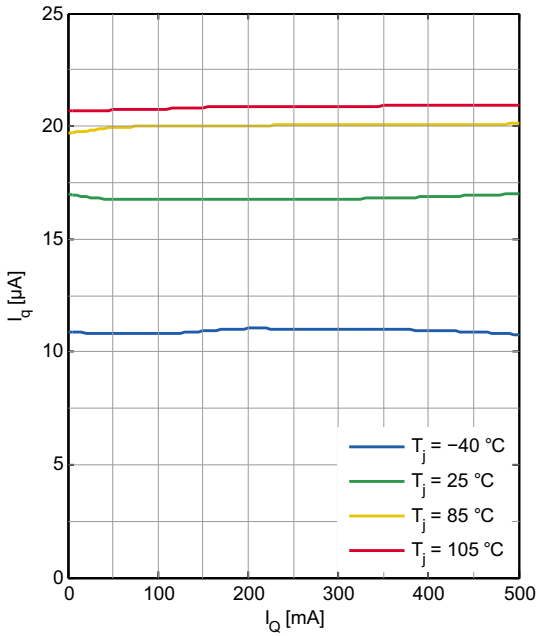

Current consumption I_q versus input voltage V_I

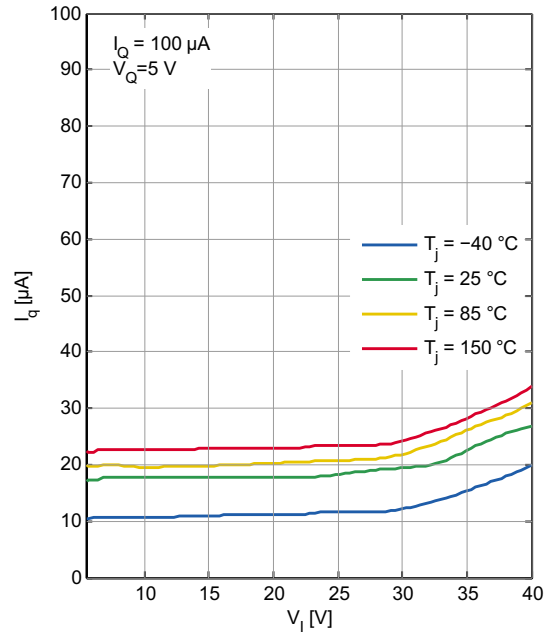

Current consumption I_q versus junction temperature T_j

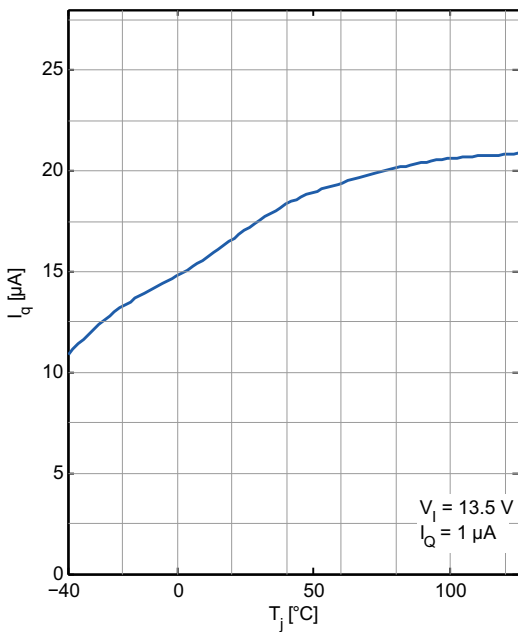

Current consumption $I_{q,off}$ versus input voltage V_I (disabled)

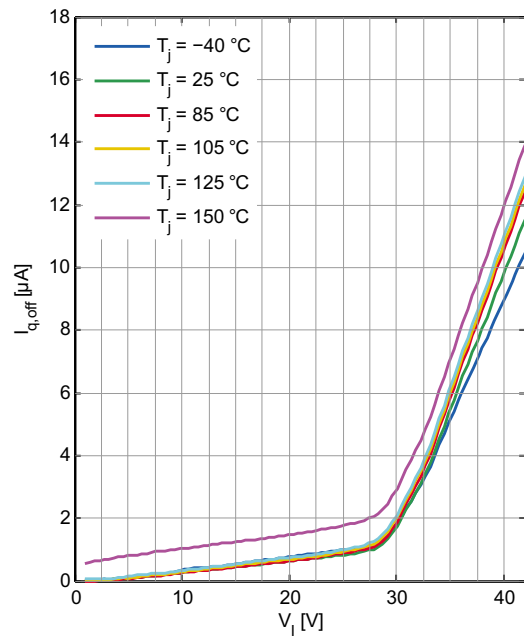

Block description and electrical characteristics

**Current consumption $I_{q,off}$ versus
junction temperature T_j (disabled)**

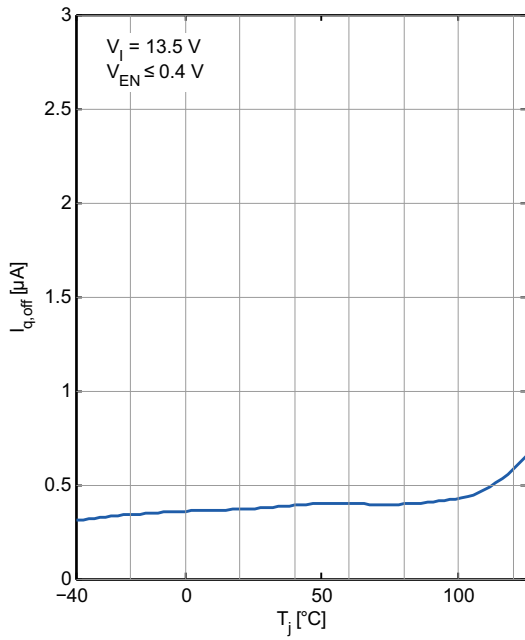

Block description and electrical characteristics

4.5 Enable function

The TLS850B0TEV50 can be switched on and off by the enable feature. Applying a high level as specified below (for example, battery voltage) to the EN pin enables the device. Applying a low level as specified below (for example, GND) shuts down the device. If a signal with slow slope is applied to the EN pin, the built-in hysteresis of the enable feature avoids toggling between the ON/OFF states.

Table 7 Electrical characteristics: enable function

$T_j = -40^\circ\text{C}$ to $+150^\circ\text{C}$, $V_I = 13.5\text{ V}$, all voltages with respect to ground (unless otherwise specified)
 Typical values are given at $T_j = 25^\circ\text{C}$

Parameter	Symbol	Values			Unit	Note or Test Condition	Number
		Min.	Typ.	Max.			
High-level input voltage	$V_{\text{EN,H}}$	2	–	–	V	V_Q settled	P_5.5.1
Low-level input voltage	$V_{\text{EN,L}}$	–	–	0.8	V	$V_Q \leq 0.1\text{ V}$	P_5.5.2
Enable threshold hysteresis	$V_{\text{EN,Hy}}$	90	–	–	mV	–	P_5.5.3
High-level input current	$I_{\text{EN,H}}$	–	–	4	μA	$V_{\text{EN}} = 5\text{ V}$	P_5.5.4
High-level input current	$I_{\text{EN,H}}$	–	–	20	μA	$V_{\text{EN}} \leq 18\text{ V}$	P_5.5.5
Enable internal pull-down resistor	R_{EN}	1.25	2	3.5	$\text{M}\Omega$	–	P_5.5.6

4.6 Typical performance characteristics: enable function

Enable input current I_{EN} versus enable input voltage V_{EN}

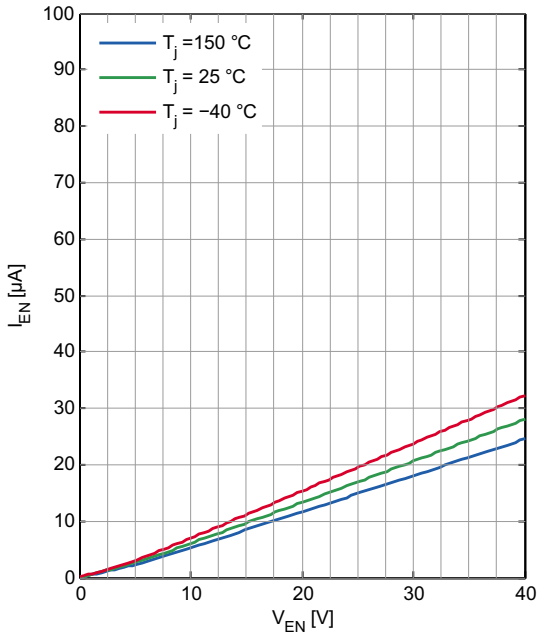

Output voltage V_Q versus time t (EN switched ON)

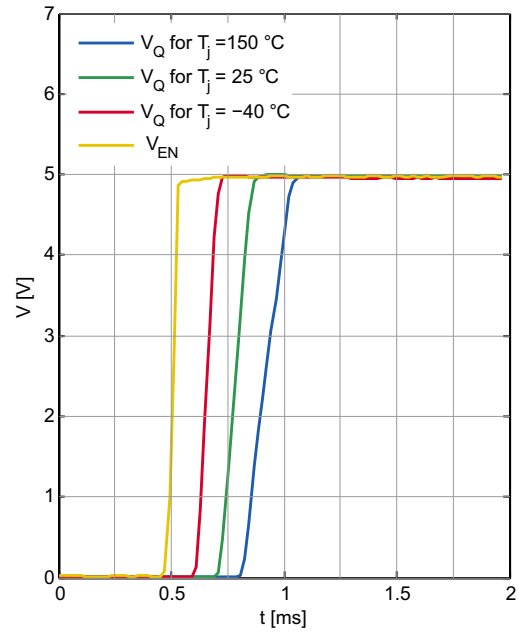

Application information

5 Application information

5.1 Application diagram

Note: The following information is given as a hint for the implementation of the device only and shall not be regarded as a description or warranty of a certain functionality, condition, or quality of the device.

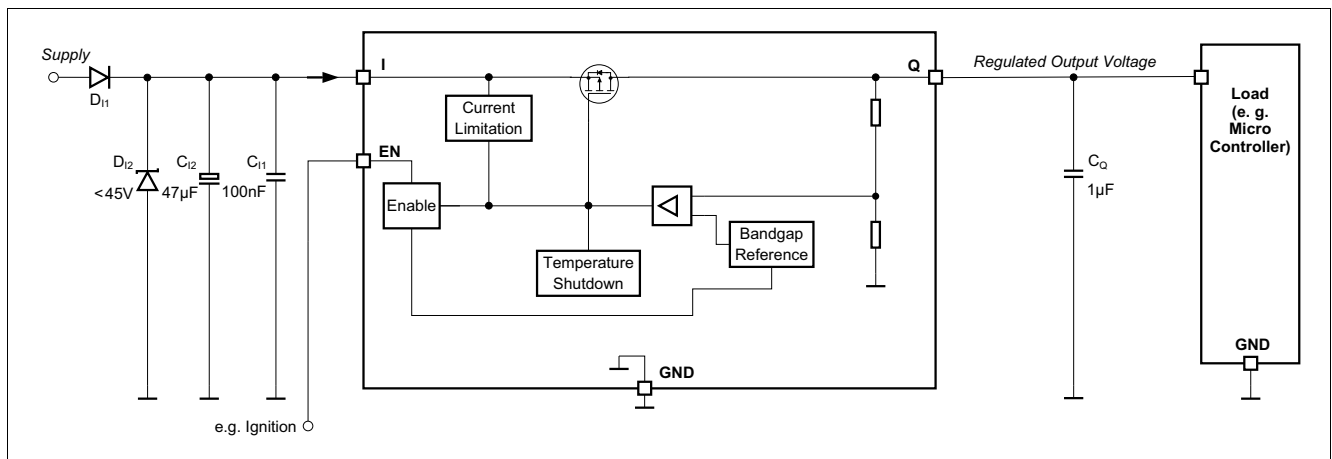

Figure 5 Application diagram

Note: This is a very simplified example of an application circuit. The function must be verified in the real application.

5.2 Selection of external components

5.2.1 Input pin

Figure 5 shows the typical input circuitry for a linear voltage regulator. A ceramic capacitor at the input, in the range of 100 nF to 470 nF, is recommended to filter the high frequency disturbances imposed by the line, for example, ISO pulses 3a/b. This capacitor must be placed very close to the input pin of the linear voltage regulator on the PCB.

An aluminum electrolytic capacitor in the range of 10 µF to 470 µF is recommended as an input buffer to damp high energy pulses, such as ISO pulse 2a. This capacitor must be placed close to the input pin of the linear voltage regulator.

An overvoltage suppressor diode can be used to further suppress any high voltage beyond the maximum rating of the linear voltage regulator and to protect the device from damage due to overvoltage.

The external components at the input pin are optional, but they are recommended in case of possible external disturbances.

5.2.2 Output pin

An output capacitor is mandatory for the stability of linear voltage regulators.

The requirement to the output capacitor is given in **Table 3**.

Application information

TLS850B0TEV50 is designed to also be stable with low-ESR capacitors. According to the automotive requirements, ceramic capacitors with X5R or X7R dielectrics are recommended.

The output capacitor should be placed as close as possible to the voltage regulator's output pin and GND pin, on the same side of the PCB as the regulator itself.

In case of input voltage transients or load current transients, the capacitance should be dimensioned in accordance, and verified in the real application that the output stability requirements are fulfilled.

5.3 Thermal considerations

The total power dissipation can be calculated from the known input voltage, the output voltage and the load profile of the application:

$$P_D = (V_I - V_Q) \times I_Q + V_I \times I_q \quad (5.1)$$

with

- P_D : continuous power dissipation
- V_I : input voltage
- V_Q : output voltage
- I_Q : output current
- I_q : quiescent current

The maximum acceptable thermal resistance R_{thJA} is:

$$R_{thJA,max} = (T_{j,max} - T_a) / P_D \quad (5.2)$$

with

- $T_{j,max}$: maximum allowed junction temperature
- T_a : ambient temperature

Based on the above calculation, the proper PCB type and the necessary heat sink area can be determined with reference to the specification in [Thermal resistance](#).

5.4 Reverse-polarity protection

TLS850B0TEV50 is not protected against reverse-polarity faults and must be protected by external components against negative supply voltage. An external reverse-polarity diode is necessary. The absolute maximum ratings of the device as specified in [Absolute maximum ratings](#) must be maintained.

5.5 Further application information

For further information, visit <http://www.infineon.com/>

6 Package outlines

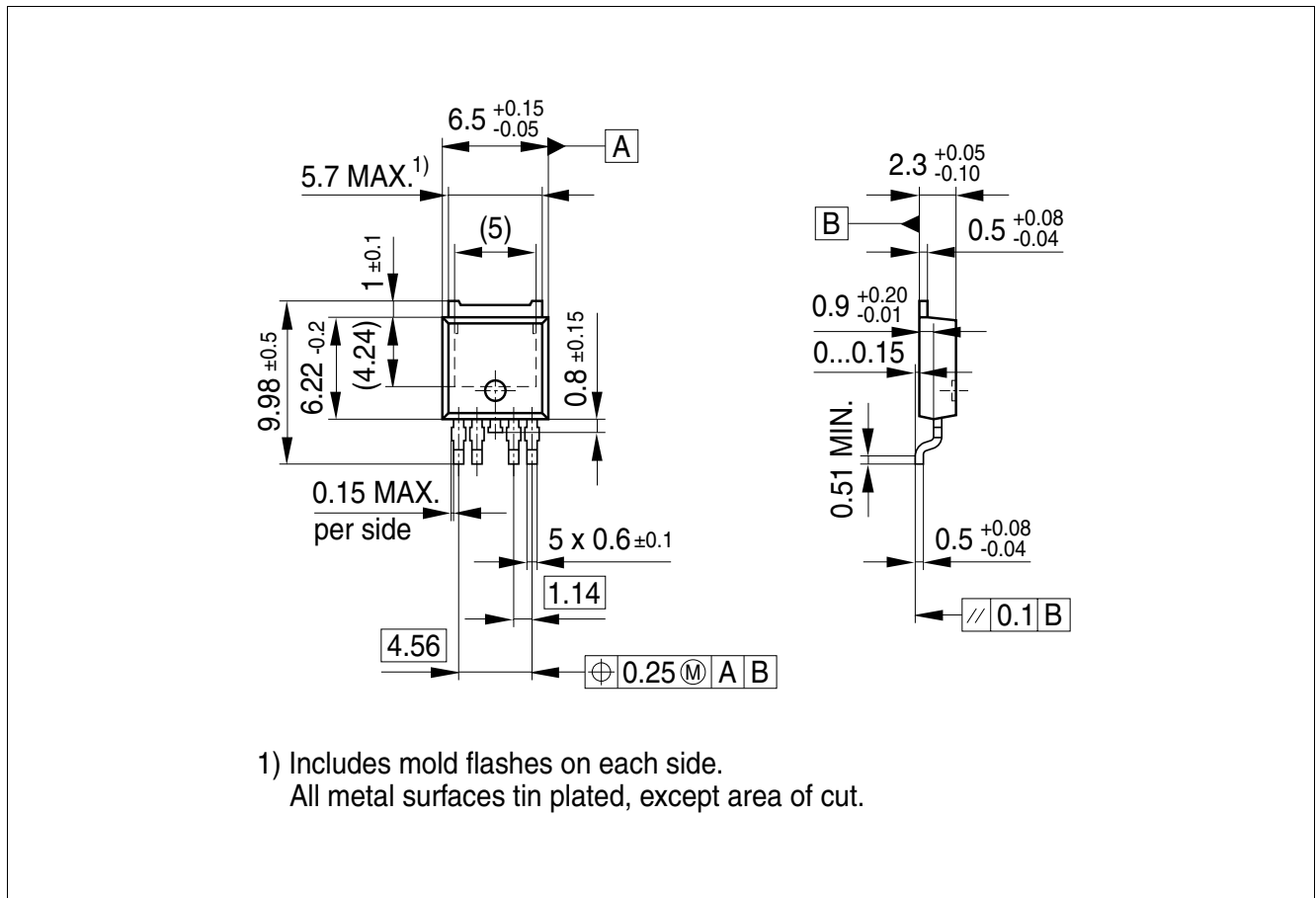

Figure 6 PG-T0252-5¹⁾

Green Product (RoHS-compliant)

To meet the world-wide customer requirements for environmentally friendly products and to be compliant with government regulations the device is available as a Green Product. Green Products are RoHS-compliant (Pb-free finish on leads and suitable for Pb-free soldering according to IPC/JEDEC J-STD-020).

Further information on packages

<https://www.infineon.com/packages>

1) Dimensions in mm

Revision history

7 Revision history

Revision	Date	Changes
1.02	2024-07-03	Editorial changes
1.01	2024-02-15	Editorial changes and template update
1.00	2017-09-26	Initial version

Trademarks

All referenced product or service names and trademarks are the property of their respective owners.

Edition 2024-07-03

Published by

Infineon Technologies AG

81726 Munich, Germany

© 2024 Infineon Technologies AG.

All Rights Reserved.

Do you have a question about any aspect of this document?

Email: erratum@infineon.com

Document reference

Z8F57878091

IMPORTANT NOTICE

The information given in this document shall in no event be regarded as a guarantee of conditions or characteristics ("Beschaffheitsgarantie").

With respect to any examples, hints or any typical values stated herein and/or any information regarding the application of the product, Infineon Technologies hereby disclaims any and all warranties and liabilities of any kind, including without limitation warranties of non-infringement of intellectual property rights of any third party.

In addition, any information given in this document is subject to customer's compliance with its obligations stated in this document and any applicable legal requirements, norms and standards concerning customer's products and any use of the product of Infineon Technologies in customer's applications.

The data contained in this document is exclusively intended for technically trained staff. It is the responsibility of customer's technical departments to evaluate the suitability of the product for the intended application and the completeness of the product information given in this document with respect to such application.

For further information on technology, delivery terms and conditions and prices, please contact the nearest Infineon Technologies Office (www.infineon.com).

WARNINGS

Due to technical requirements products may contain dangerous substances. For information on the types in question please contact your nearest Infineon Technologies office.

Except as otherwise explicitly approved by Infineon Technologies in a written document signed by authorized representatives of Infineon Technologies, Infineon Technologies' products may not be used in any applications where a failure of the product or any consequences of the use thereof can reasonably be expected to result in personal injury.