

Product Brief

TLS115xx

High performance sensor supply IC



The TLS115xx is a monolithic integrated low-dropout voltage tracking regulator with high accuracy in small DSO-8 exposed pad and TSON-10 packages. The IC is designed to supply off-board systems, for example sensors in powertrain management systems under the severe conditions of automotive applications. Therefore, the IC is equipped with additional protection functions against reverse polarity and short circuit to GND and battery. With supply voltages up to 45 V, the output voltage follows the reference voltage applied at the adjust input with very high accuracy. The reference voltage applied to the adjust input can be down to 2.0 V and output is able to drive loads up to 150 mA while the device follows the reference voltage (e.g. the 5 V output of a main voltage regulator) with very high precision.

Key features

- > Designed for automotive at 150°C
- > Short to GND and V_{Batt} protected
- > High accuracy tracking
- > Overvoltage and undervoltage monitor

Key benefits

- > Reliable protection for ECU/sensor
- > Easy and accurate voltage replication
- > High flexibility/scalability
- > Lower design effort → design cost saving

Applications

- > Automotive sensor supply
- > Protected sensor supply for off-board sensors
- > Secondary voltage supply in automotive ECU
- > High-precision voltage replication
- > Power switch for off-board load

Application schematic

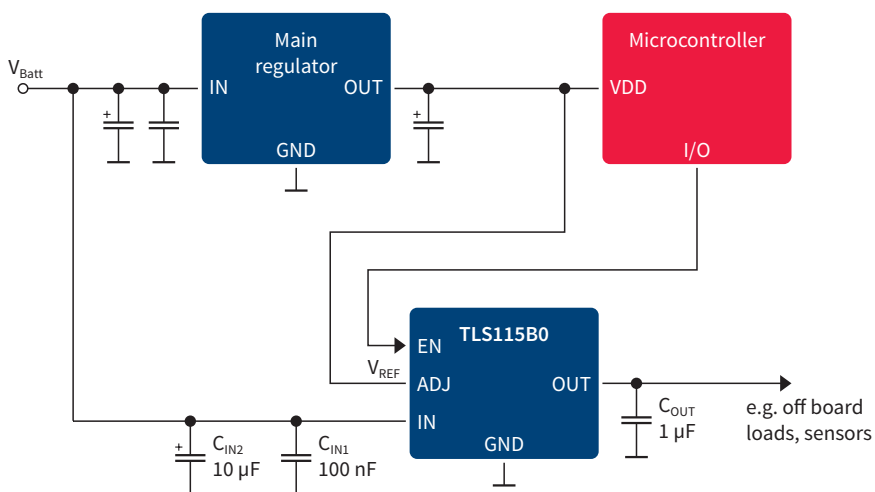

Product table

Product	OPN	Accuracy	Status pin	Package
TLS115B0EJ	TLS115B0EJXUMA1	± 0.1%	–	PG-DSO-8 EP
TLS115B0LD	TLS115B0LDXUMA1	± 0.1%	–	TSON10-EP
TLS115D0EJ	TLS115D0EJXUMA1	± 0.1%	Yes	PG-DSO-8 EP
TLS115D0LD	TLS115D0LDXUMA1	± 0.1%	Yes	TSON10-EP

For more information: <http://www.infineon.com/TLS115xx>

<http://www.infineon.com/sensor-supply>

Reliable and robust sensor supply IC

Family description





Infinite offers wide portfolio of automotive sensor supply IC's, also called tracker IC. Family covers wide range of output currents from 50 mA to 400 mA and is implemented in robust technology with focus on automotive harsh environment. Multiple protection

features are implemented to protect the ECU from different issues on wire harness. Wide package offer from smallest SCT595 to power package TO263 enables flexible product selection according to space and thermal considerations.

Family overview

Product	Output current [mA]	Accuracy [%]	Tracker	Min. adjust voltage [V]	Independent EN pin	Status pin	Package
TLE4250-2	50	±0.5	Yes	2.5	-	-	SCT595
TLE4254	70	±0.1	Yes	2.0	-	Yes	DSO-8 DSO-8 EP
TLS115B0 TLS115D0	150	±0.1	Yes	2.0	Yes Yes	No Yes	DSO-8 EP TSO-10 EP
TLE4252	250	±0.2	Yes	1.5	Yes	-	TO252
TLE4253	250	±0.2	Yes	2.0	-	-	DSO-8 DSO-8 EP
TLS730D0	300	±2	No, LDO with diagnostic	3.0	Yes	Yes	TSDSO-14
TLE4251	400	±0.2	Yes	2.5	Yes	-	TO252 TO263

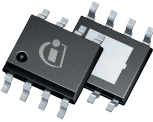
Package overview

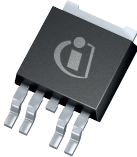
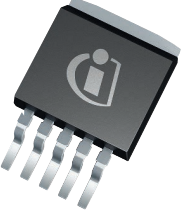
	SCT595	TSO-10 EP	DSO-8 EP	DSO-8	TO252	TO263
Outline						
Size	2.9 mm x 2.5 mm	3.3 mm x 3.3 mm	4.9 mm x 6 mm	4.9 mm x 6 mm	6.5 mm x 10 mm	10 mm x 15 mm
$R_{th} @ 2p2s^{1)}$	~81 K/W	~53 K/W	~45 K/W	~114 K/W	~25 K/W	~20 K/W

1) According to Jedis JESD51-2, -5, -7 at natural convection on FR4 2s2p board

Visit our sensor supply page for more information: <http://www.infineon.com/sensor-supply>

Published by
Infineon Technologies AG
81726 Munich, Germany

© 2016 Infineon Technologies AG.
All Rights Reserved.

Please note!

THIS DOCUMENT IS FOR INFORMATION PURPOSES ONLY AND ANY INFORMATION GIVEN HEREIN SHALL IN NO EVENT BE REGARDED AS A WARRANTY, GUARANTEE OR DESCRIPTION OF ANY FUNCTIONALITY, CONDITIONS AND/OR QUALITY OF OUR PRODUCTS OR ANY SUITABILITY FOR A PARTICULAR PURPOSE. WITH REGARD TO THE TECHNICAL SPECIFICATIONS OF OUR PRODUCTS, WE KINDLY ASK YOU TO REFER TO THE RELEVANT PRODUCT DATA SHEETS PROVIDED BY US. OUR CUSTOMERS AND THEIR TECHNICAL DEPARTMENTS ARE REQUIRED TO EVALUATE THE SUITABILITY OF OUR PRODUCTS FOR THE INTENDED APPLICATION.

WE RESERVE THE RIGHT TO CHANGE THIS DOCUMENT AND/OR THE INFORMATION GIVEN HEREIN AT ANY TIME.

Additional information

For further information on technologies, our products, the application of our products, delivery terms and conditions and/or prices, please contact your nearest Infineon Technologies office (www.infineon.com).

Warnings

Due to technical requirements, our products may contain dangerous substances. For information on the types in question, please contact your nearest Infineon Technologies office.

Except as otherwise explicitly approved by us in a written document signed by authorized representatives of Infineon Technologies, our products may not be used in any life-endangering applications, including but not limited to medical, nuclear, military, life-critical or any other applications where a failure of the product or any consequences of the use thereof can result in personal injury.