

Quick start guide

KIT_DRIVER_2EDN7524G

August 2018



KIT_DRIVER_2EDN7524G



Included in this kit

Evaluation kit
KIT_DRIVER_2EDN7524G

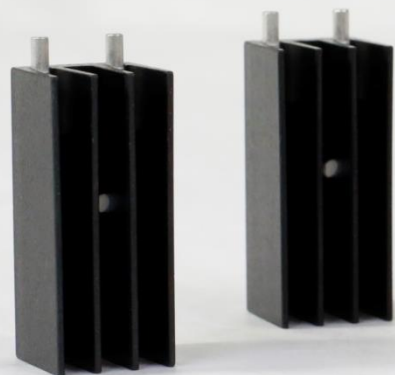

Heatsinks for
TO-220 MOSFETs

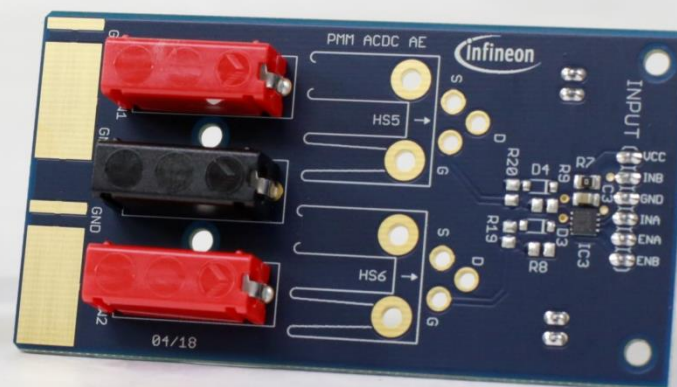

Board schematic

DRIVER INPUT CONNECTORS

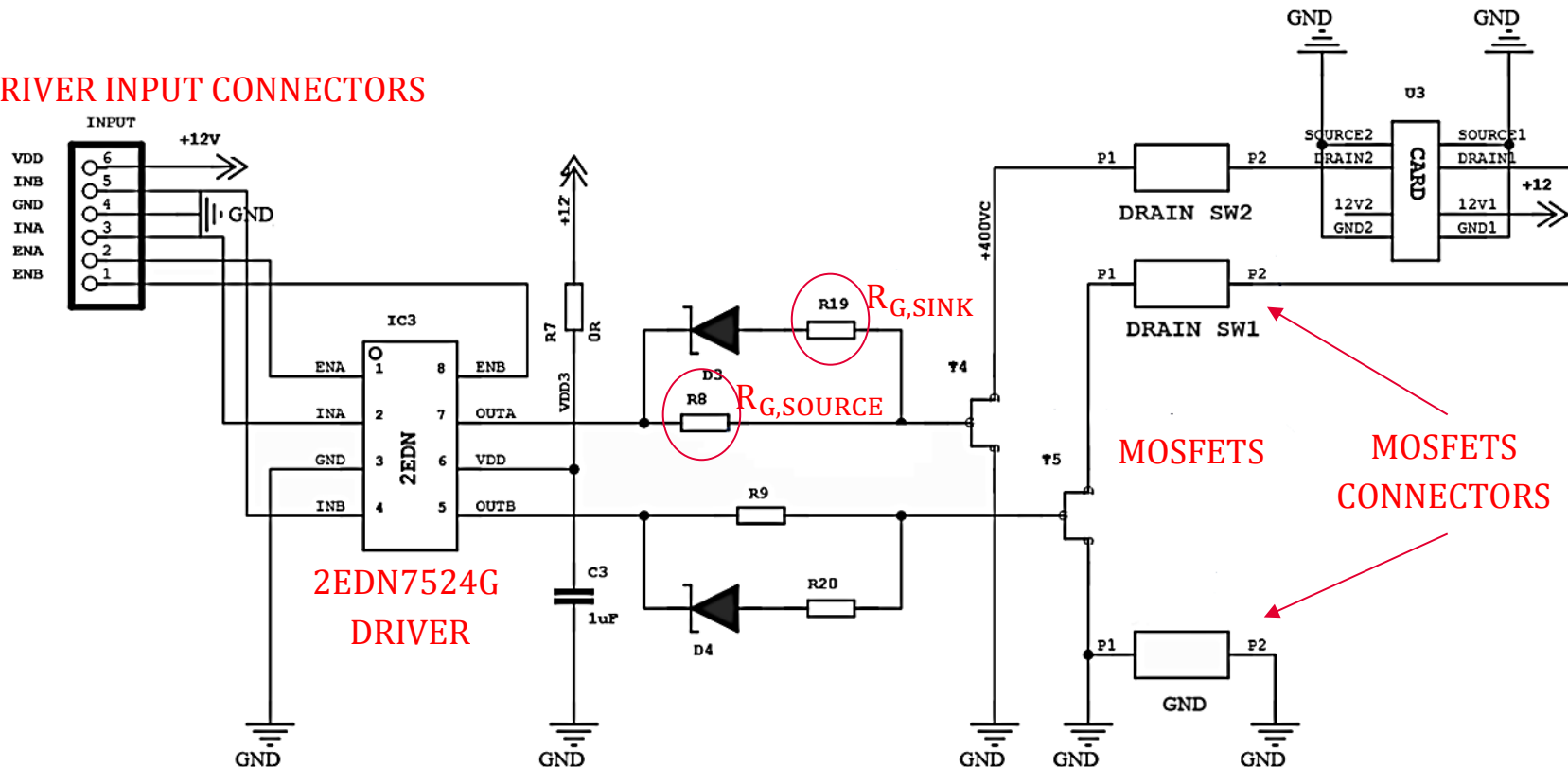

**2EDN7524G
DRIVER**







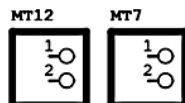
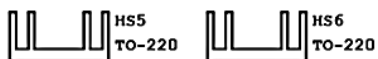

MOSFETS

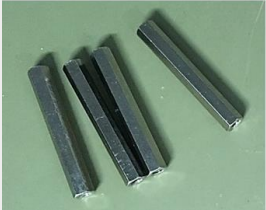
**MOSFETS
CONNECTORS**

HEATSINKS



Components to add – BOM suggestion

<p>Distance bolts</p>	<p>Screws for distance bolts</p>	<p>Screws and washers for MOSFET mounting to heatsink</p>	<p>TO-220 sockets</p>
			
<p>TO-220 MOSFETs</p>	<p>Source resistors (R8, R9)</p>	<p>Sink resistors (R19, R20)</p>	<p>Sink diodes</p>
			

Component	Quantity	Designator	Comment	Voltage	Footprint	Type	Part number/supplies
Sink diode	2	D3,D4	Schottky diode	30 V	SOD-123	PMEG3020 Schottky diode	816-6858 RS-Components
Resistors	4	R8,R9,R19,R20			RES805R	SMD ceramic resistor	
TO-220 sockets	2	T4,T5	TO-220 socket		TO-220	Receptacle Connector 0.034" ~ 0.041" (0.86 mm ~ 1.04 mm)	5050865-5 Digi-key

Step 1: Distance bolts mounting

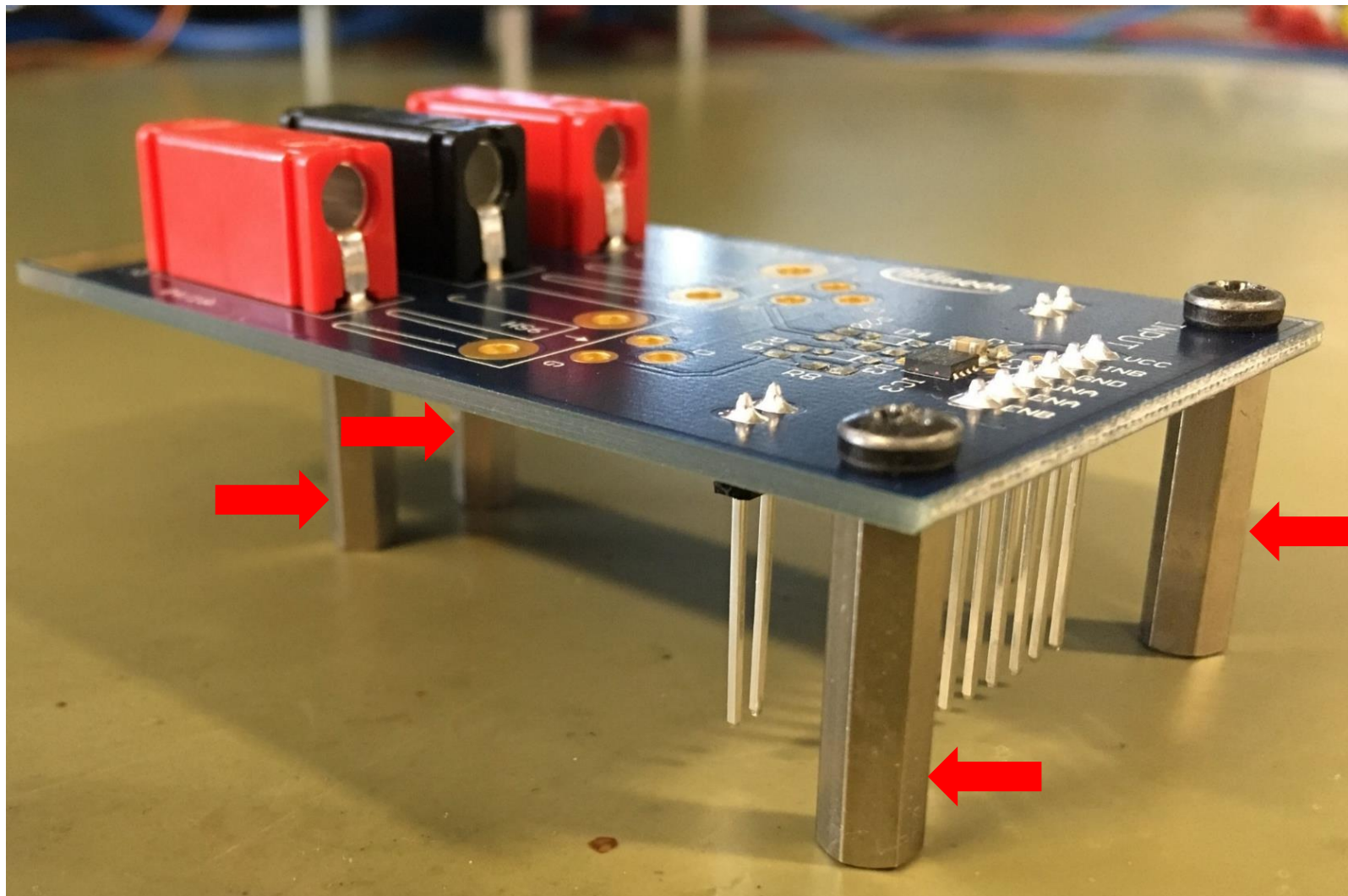

Step 2: Source resistors soldering

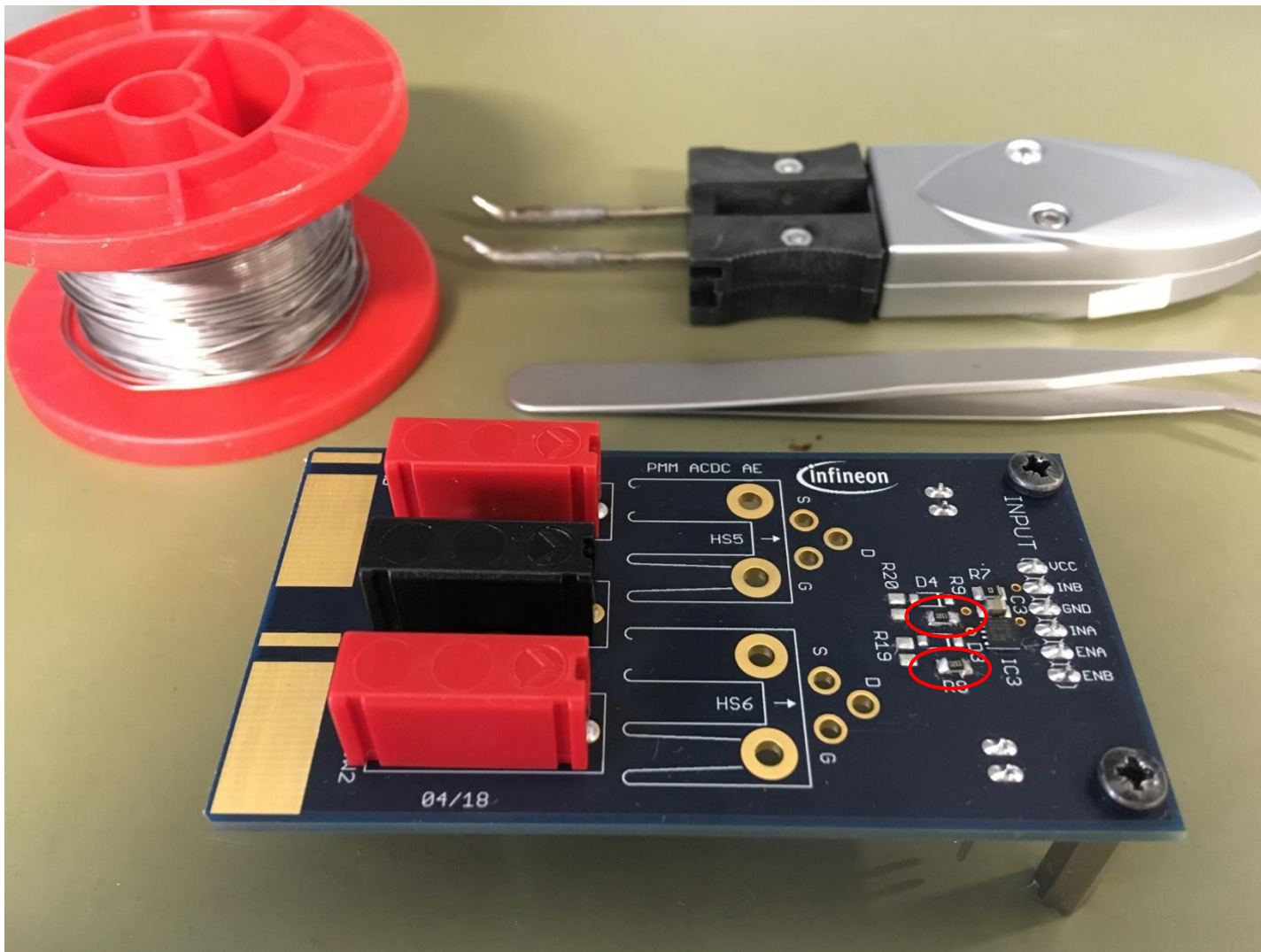

Step 3: Sink resistors and sink diodes soldering

- > Add the sink resistors and the sink diodes only if a differentiation between the turn-on and the turn-off behavior is required

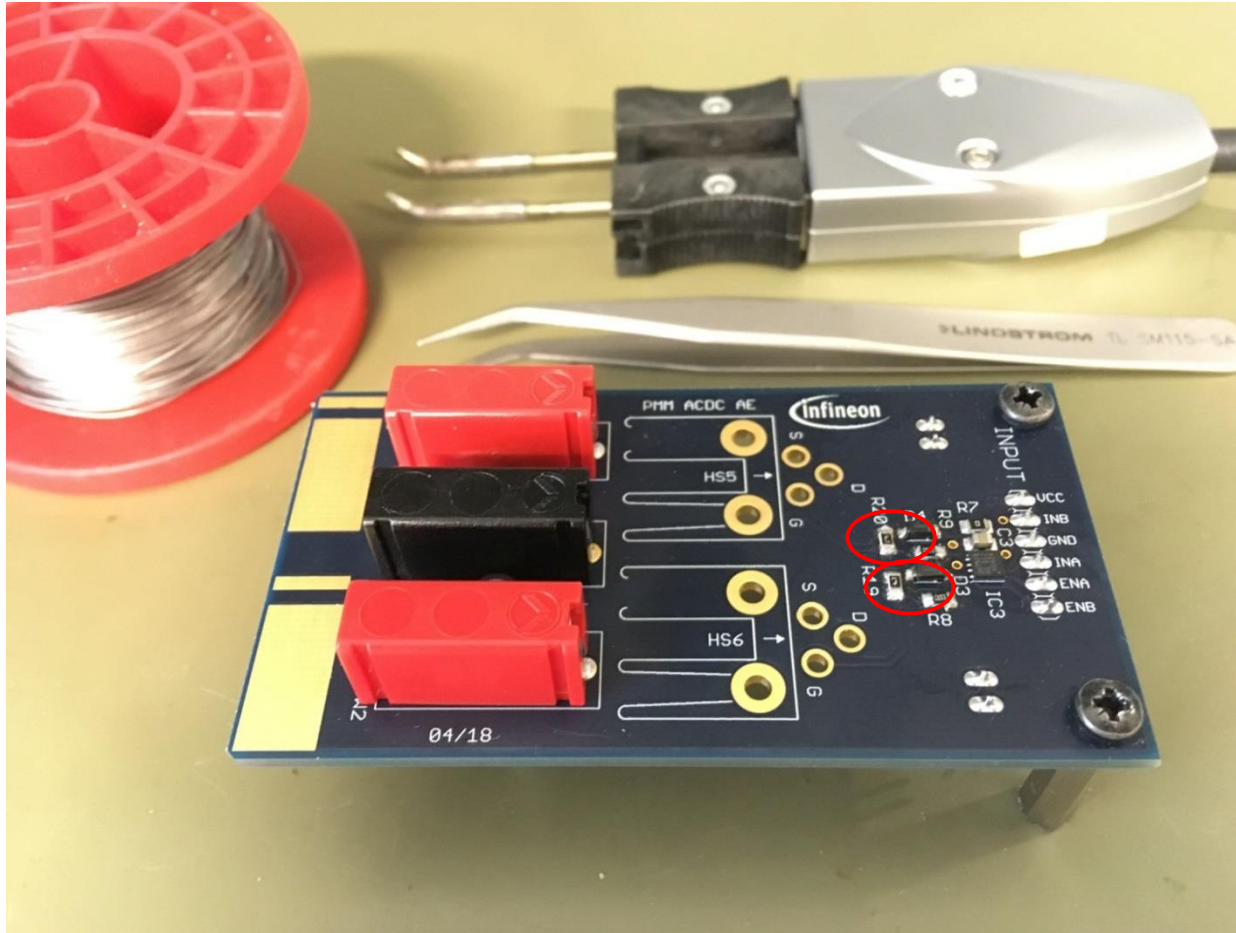

Step 4: TO-220 sockets soldering

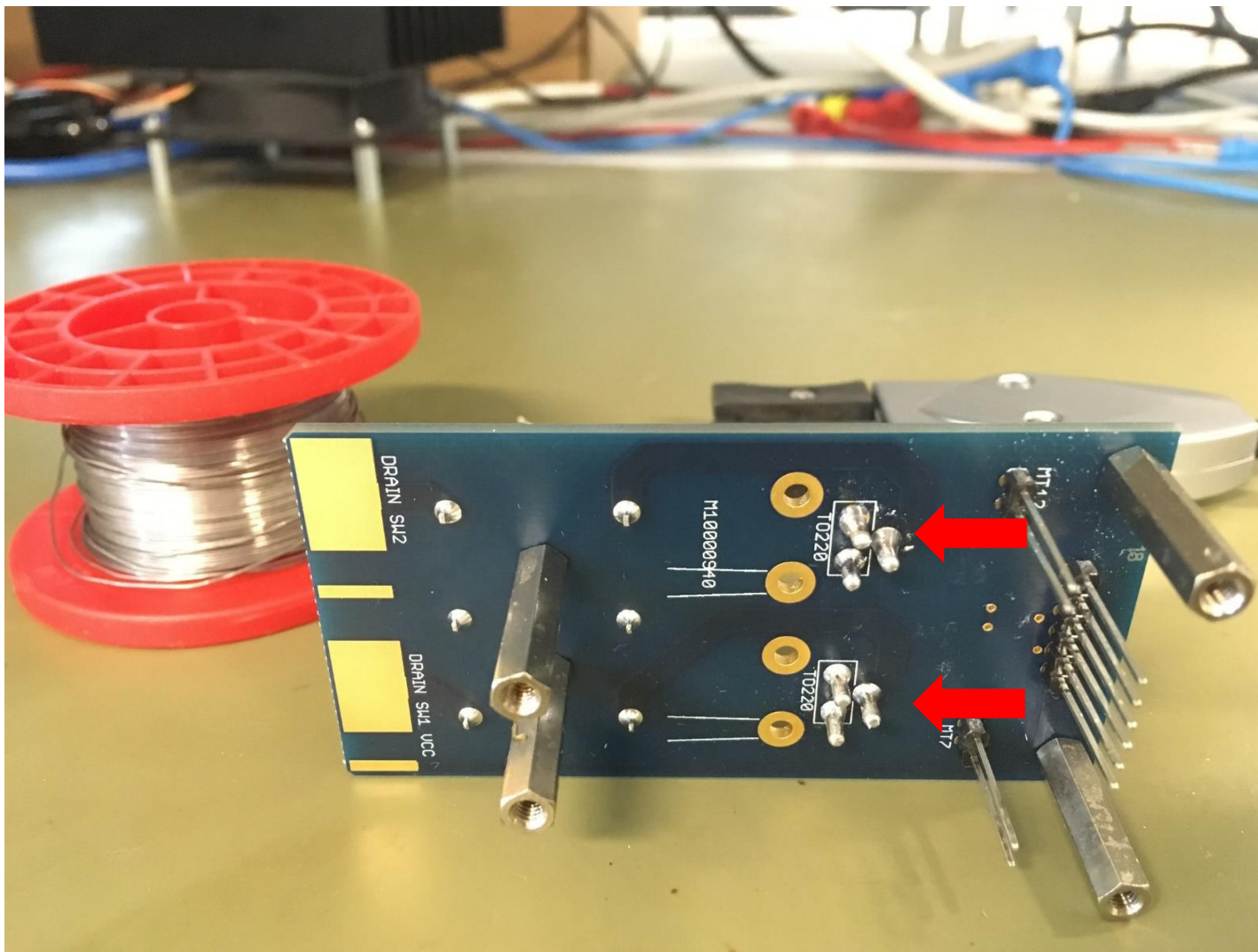

Step 5: MOSFETs placement into the sockets

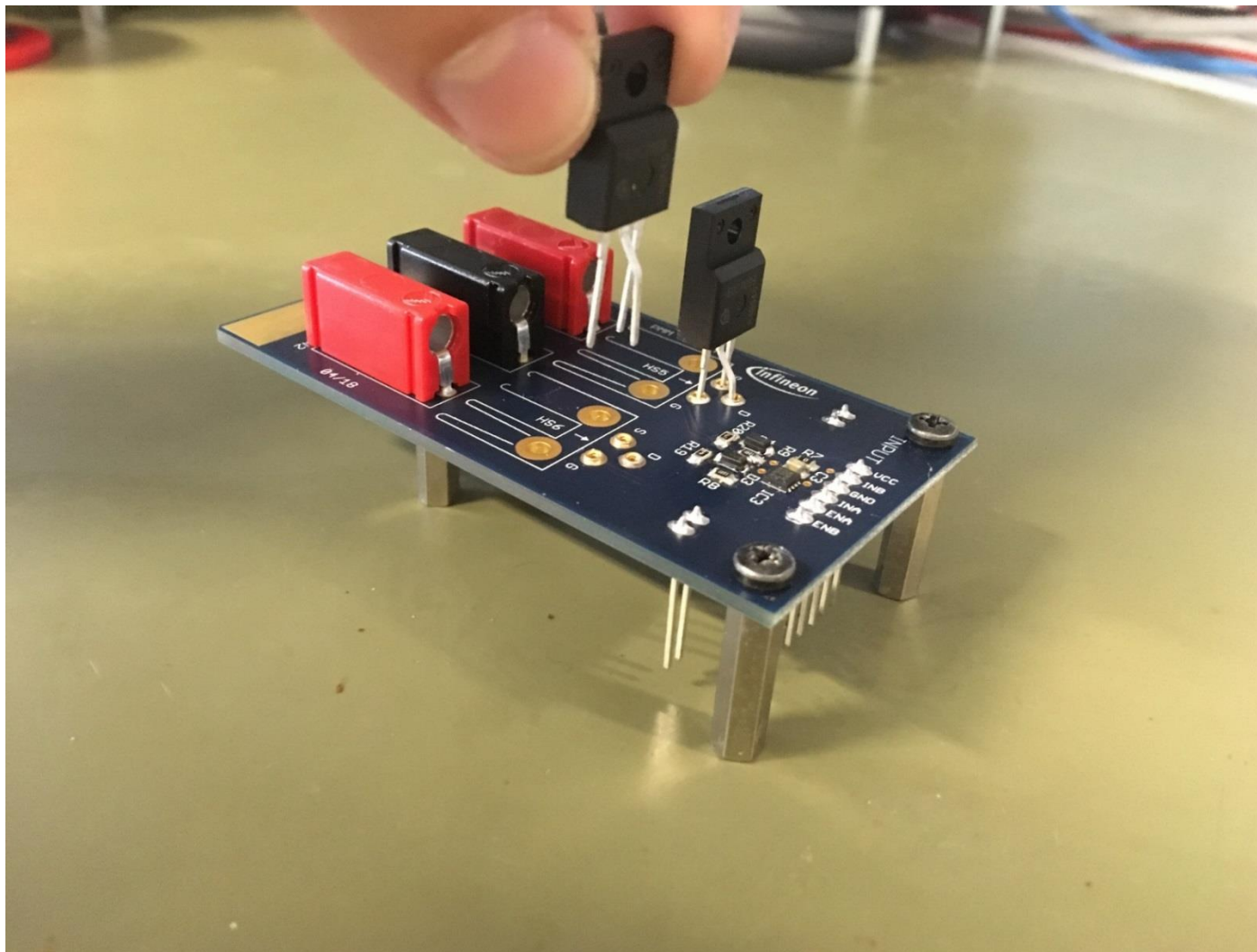

Step 6: Heatsink mounting (optional)

- > Solder the heatsink if the board is used in high voltage scenarios
- > In basic measurements it is not necessary
- > See next slide for further information on how to properly mount the MOSFETs to the heatsink

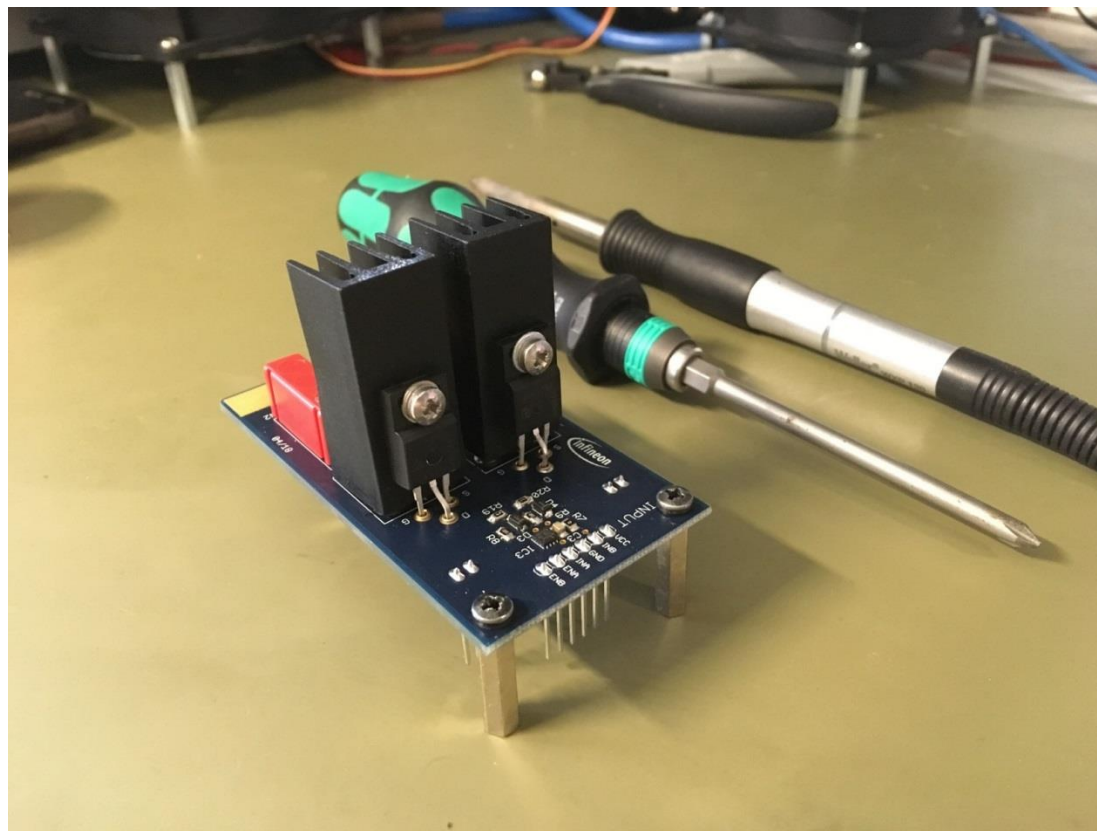

TO-220 MOSFET mounting to the heatsink

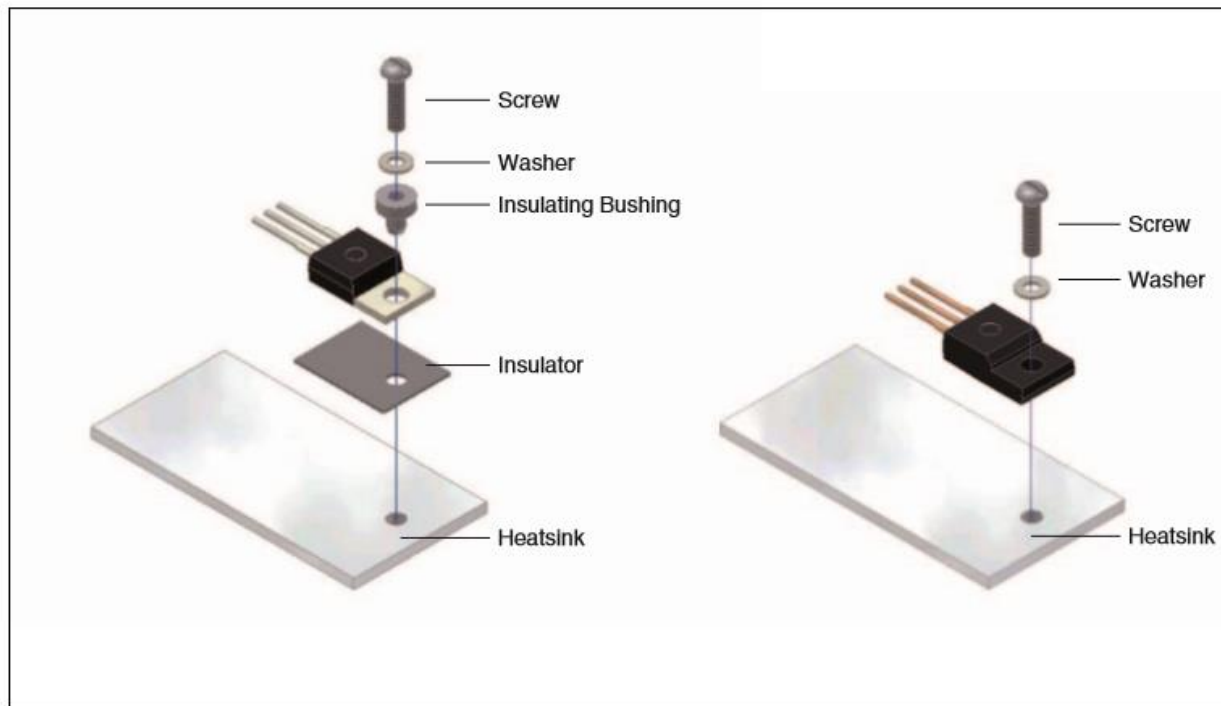

Package	Typ. Torque [Nm]	Max. Torque [Nm]	Comment
PG-TO220	0.6	0.7	Screw M3
PG-TO220 FullPAK	0.5	0.7	Screw M2.5

- > Recommendations for assembly of Infineon TO packages:
https://www.infineon.com/dgdl/Infineon-Package_recommendations_for_assembly_of_Infineon_TO_packages-AN-v01_00-EN.pdf?fileId=db3a30431936bc4b011938532f885a38

Step 7: BNC connectors soldering

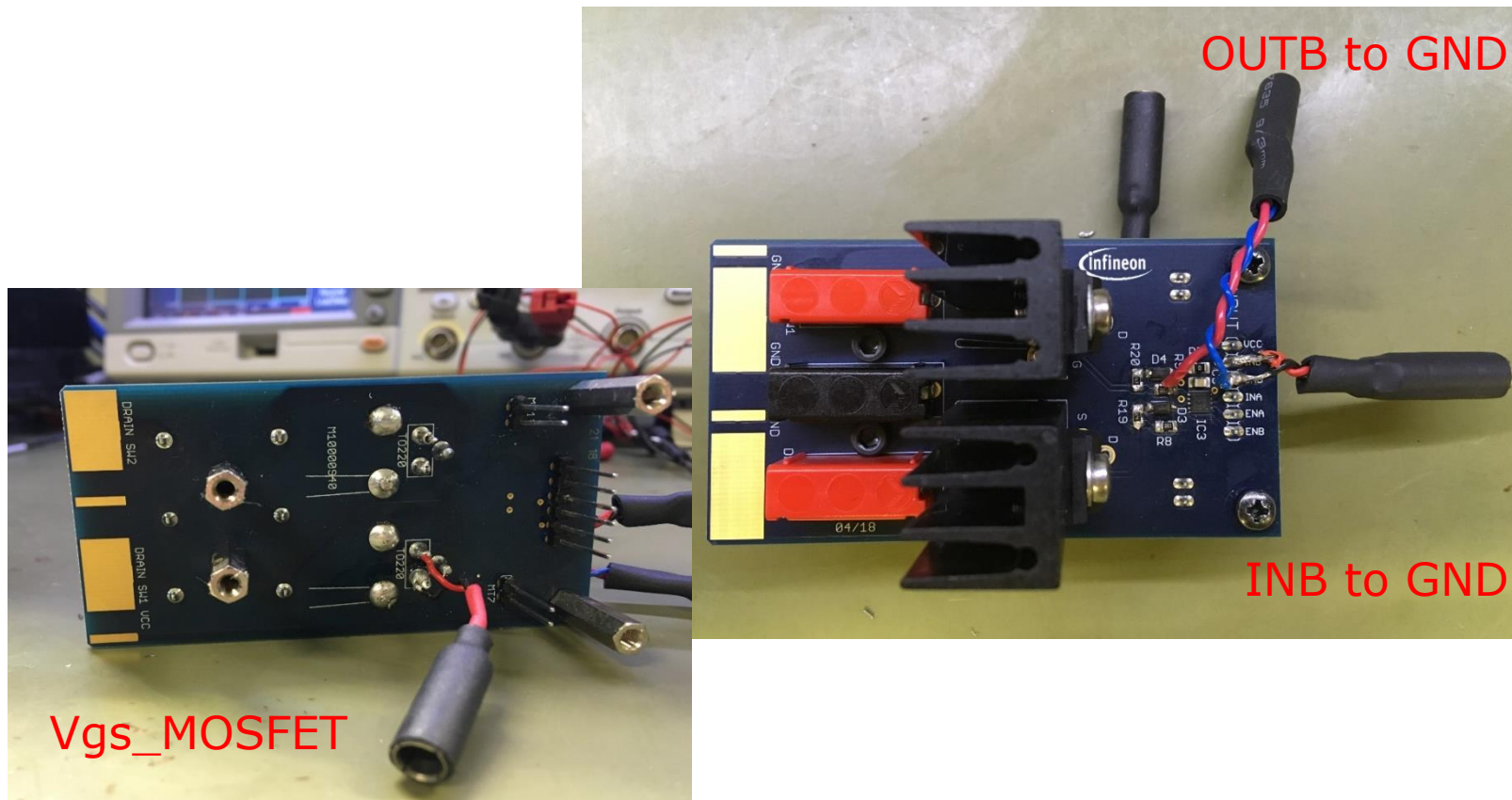

- > N.B. For soldering simplicity the connector **OUTB to GND** can be soldered on the OUTB pad of the source resistors as in photo. Anyway soldering the connector directly on the outpin pin OUTB of the driver reduces the parasitic influence on the measurement.

Instrumentation for driver supply generation

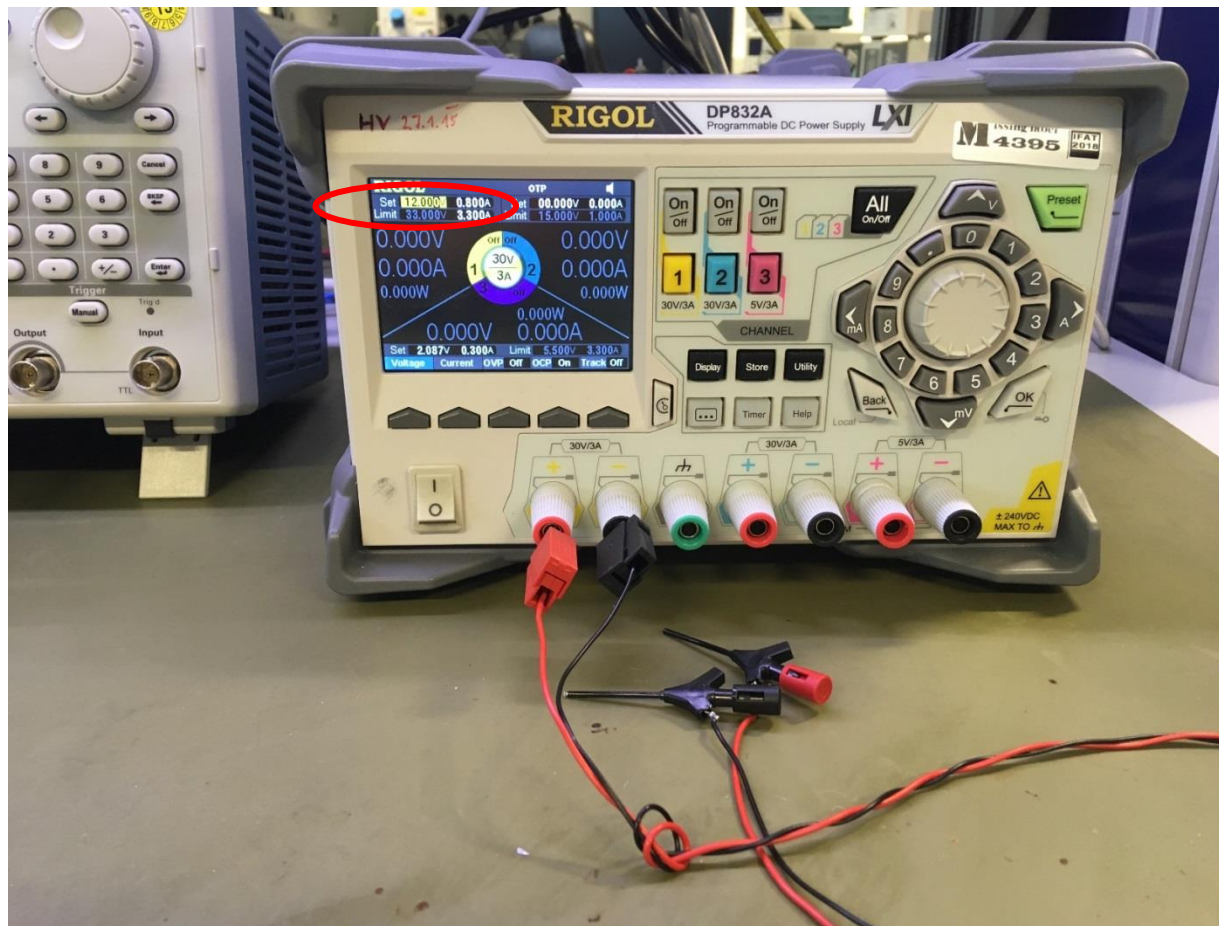

- > $V_{CC}=12\text{ V}$ for CoolMOS™ and 8 V for OptiMOS™
- > Set the current limit below 1 A (0.8 A e.g.)

Instrumentation for PWM signals generation

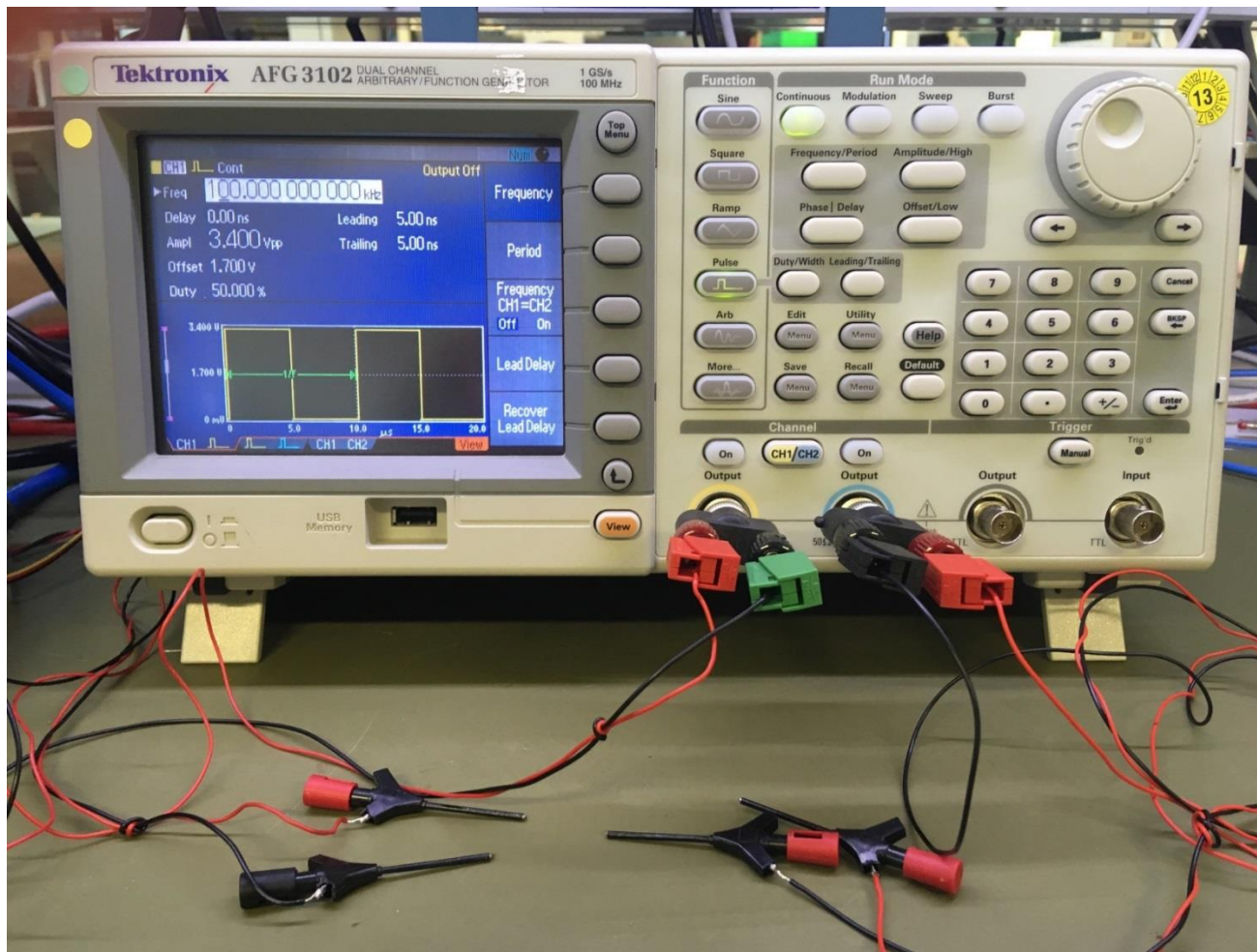

- Use a function generator or a microcontroller

Connections

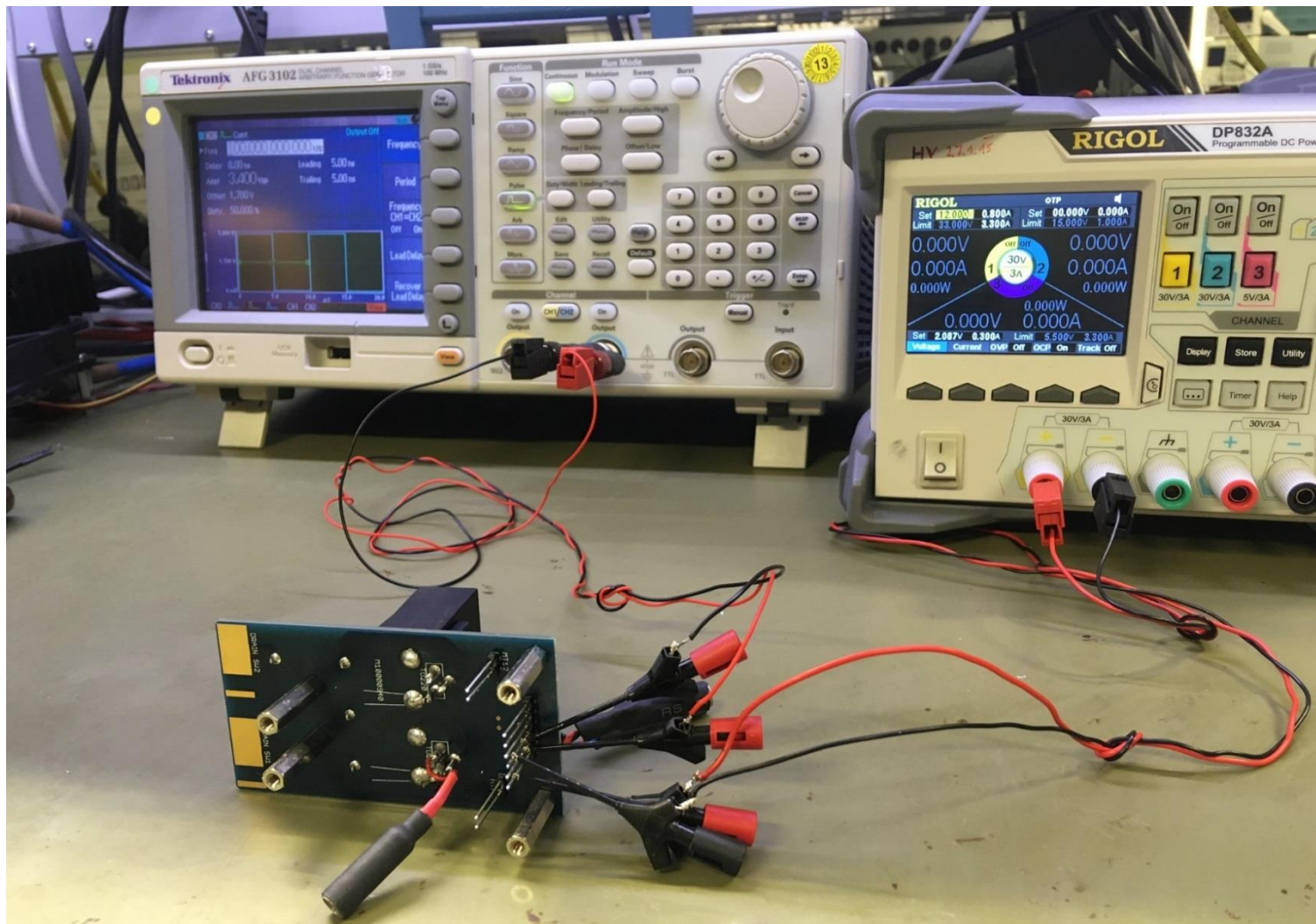

Instrumentation for signals evaluation

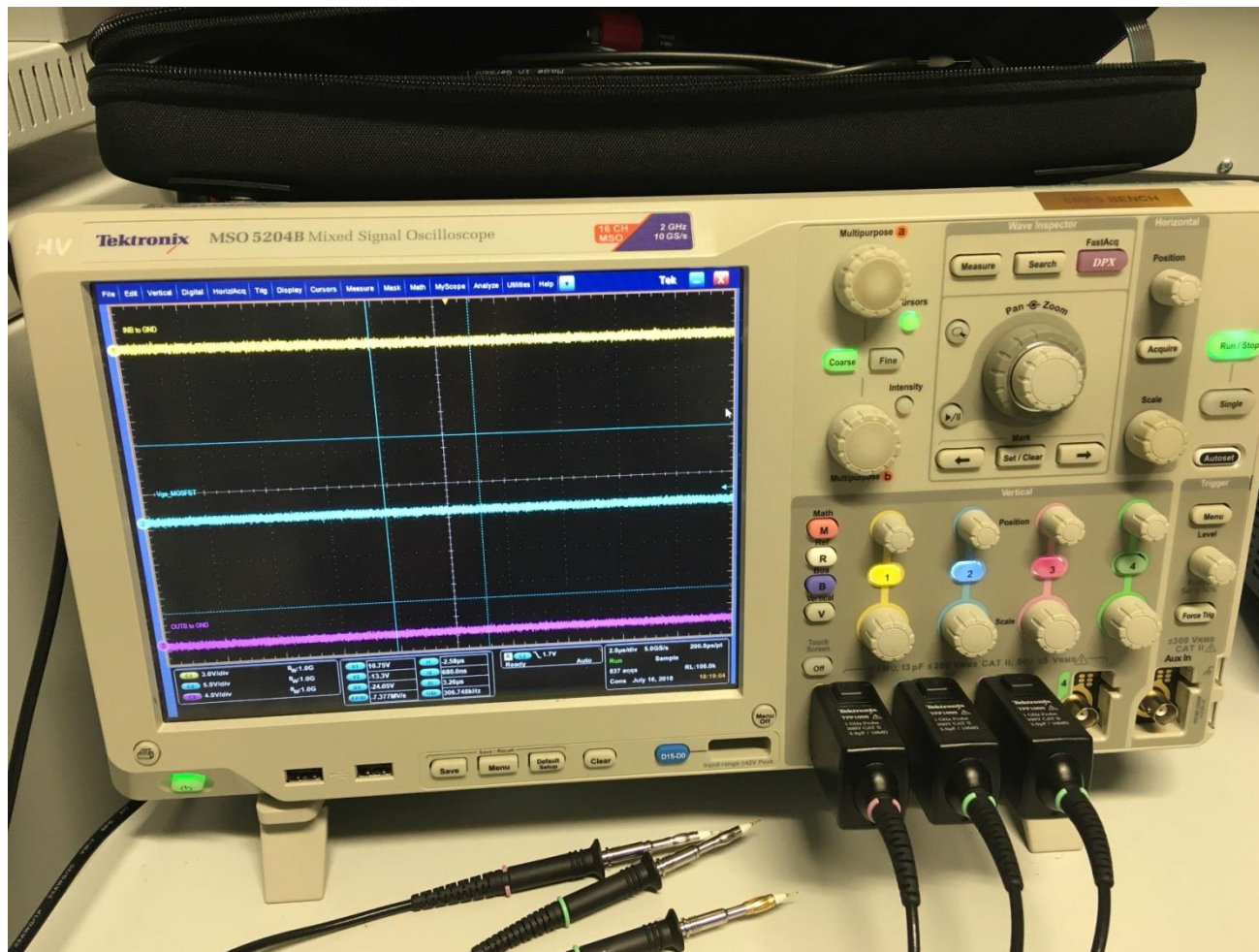

- > Voltage probes used: Tetronix TPP1000 1 GHz, 3.9 pF

Complete measurement setup

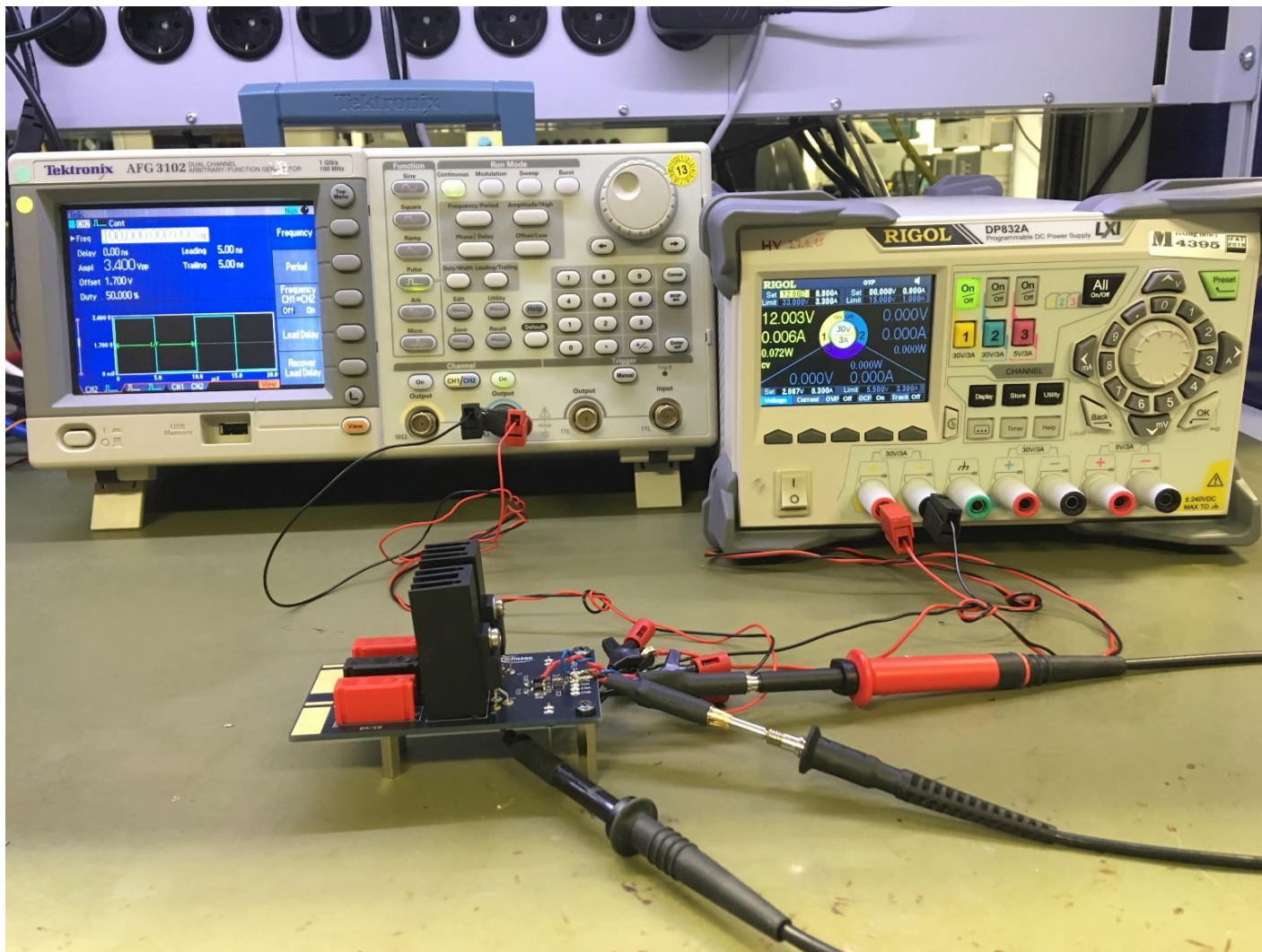

Oscilloscope waveforms

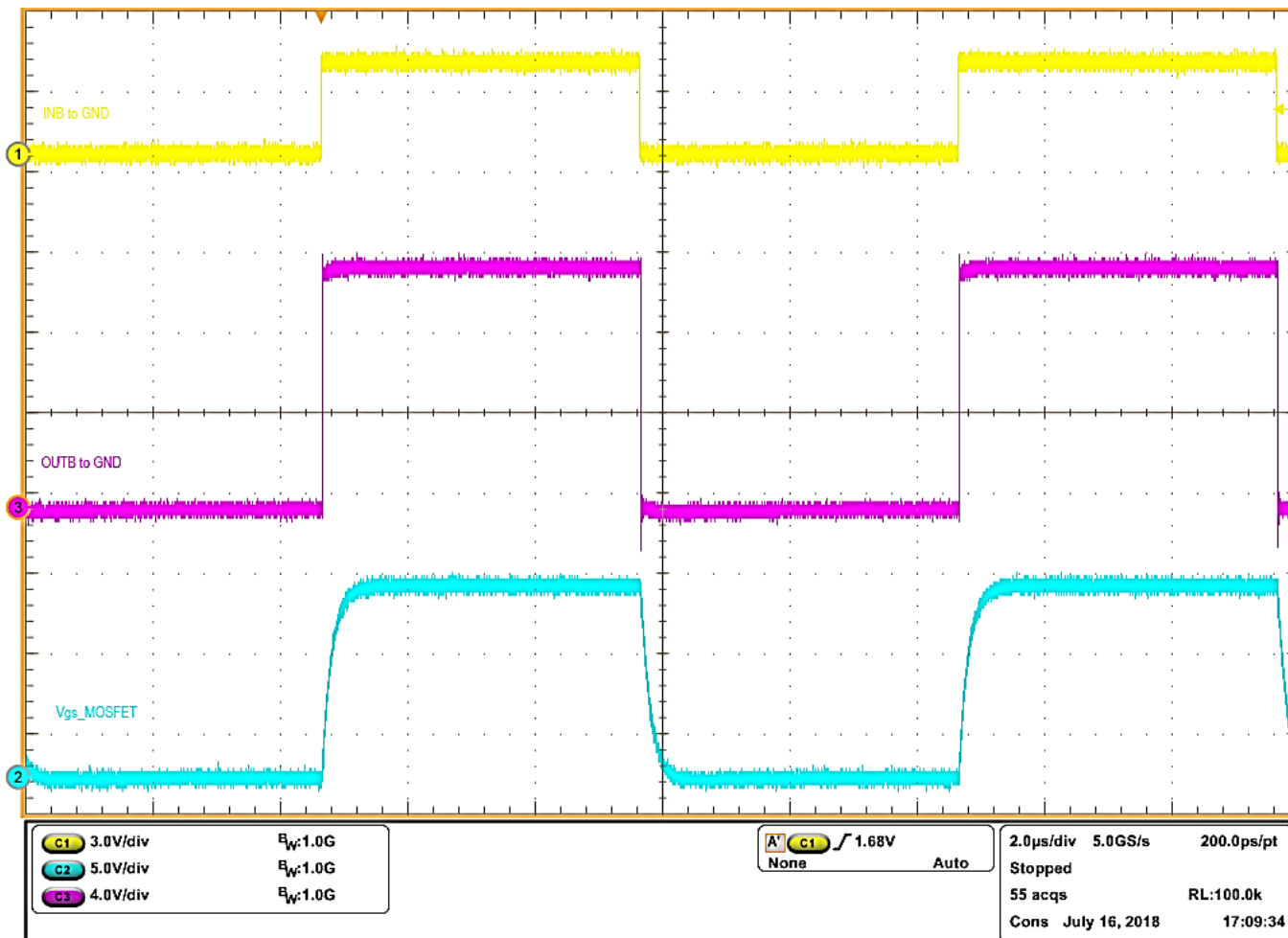

- > Measurements done on a single MOSFET with $V_{DS} = 0\text{ V}$ (drain and source shorted)

Equivalent model of the driving circuit

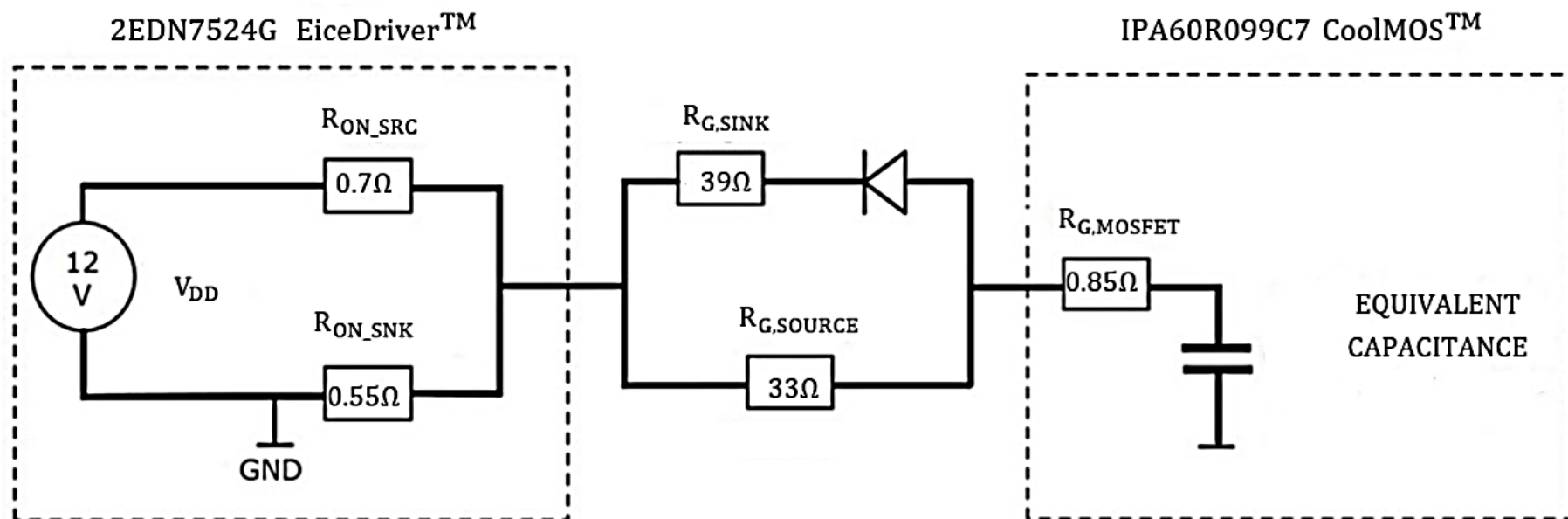

Low-high propagation delay

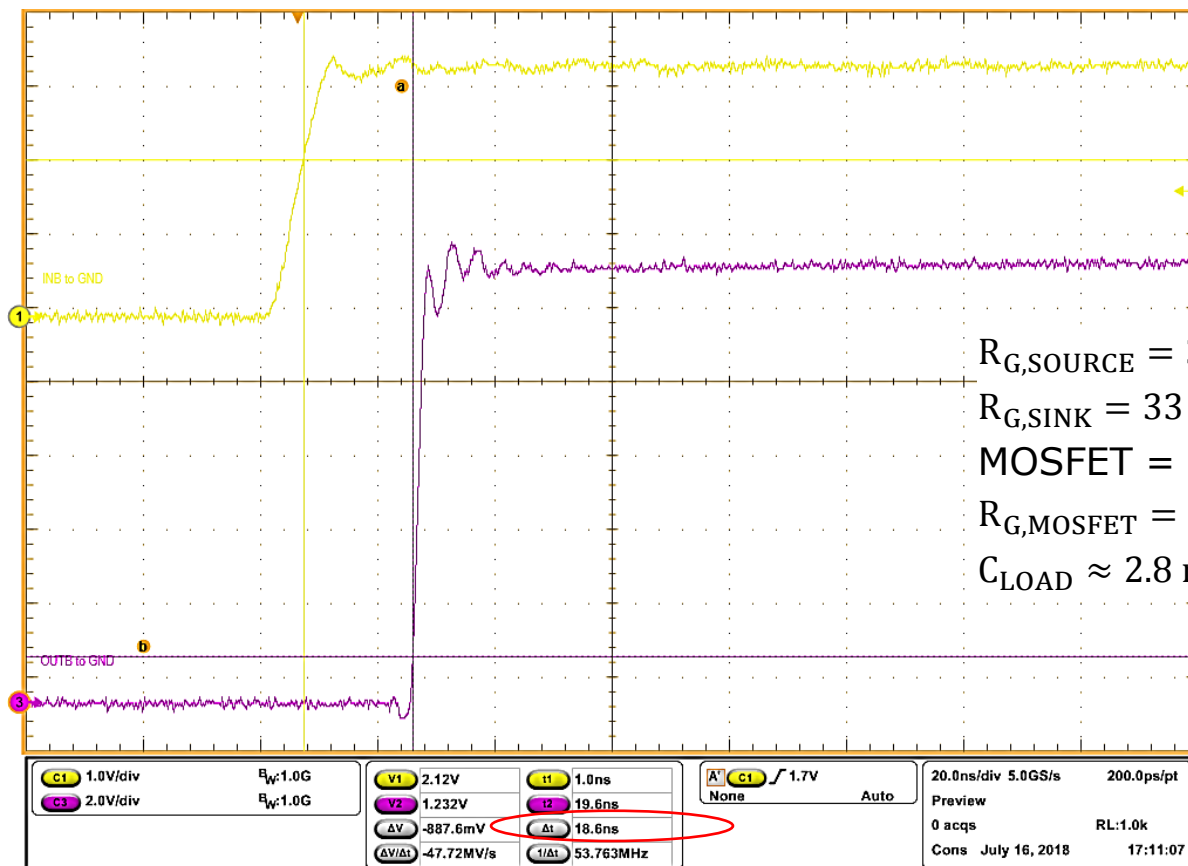

$R_{G,SOURCE} = 39 \Omega$
 $R_{G,SINK} = 33 \Omega$
 MOSFET = IPA60R099C7
 $R_{G,MOSFET} = 0.82 \Omega$
 $C_{LOAD} \approx 2.8 \text{ nF}$

- > t_{PDlh} defined in the datasheet as time interval $t(\text{OUTB} = 10\% \text{ VDD}) - t(\text{INB} = V_{INH} = 2.1 \text{ V})$ for a pure capacitive load $C_{LOAD} = 1.8 \text{ nF}$ with $R_{G,SOURCE} = 0 \Omega$
- > N.B. In the considered measurements the load is the transistor with $R_{G,MOSFET} = 0.82 \Omega$, $R_{G,SOURCE} = 39 \Omega$, $C_{LOAD} \approx 2.8 \text{ nF}$ (see slide 23 for C_{LOAD} calculation)

High-Low propagation delay

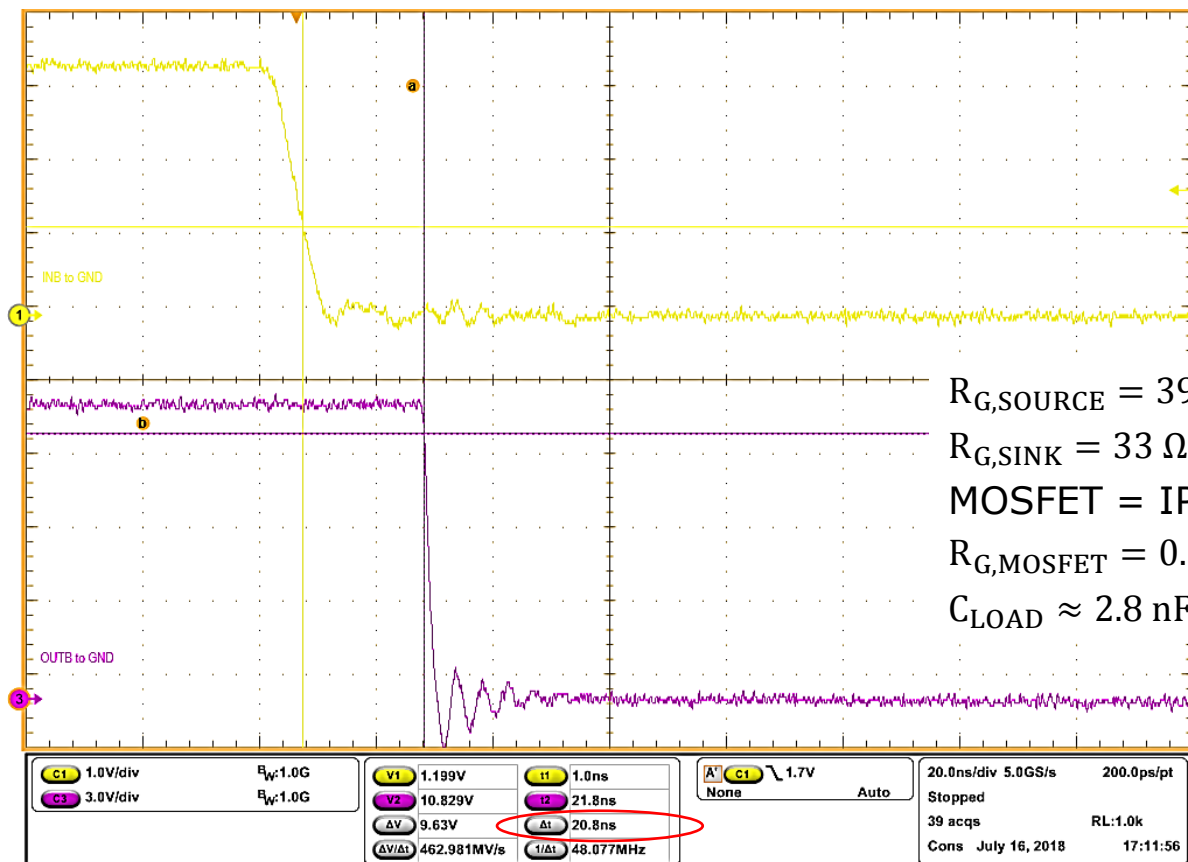

$R_{G,SOURCE} = 39 \Omega$
 $R_{G,SINK} = 33 \Omega$
MOSFET = IPA60R099C7
 $R_{G,MOSFET} = 0.82 \Omega$
 $C_{LOAD} \approx 2.8 \text{ nF}$

- > t_{PDhl} defined in the datasheet as time interval $t(\text{OUTB} = 90\% \text{ VDD}) - t(\text{INB} = V_{INL} = 1.02 \text{ V})$ for a pure capacitive load $C_{LOAD} = 1.8 \text{ nF}$ with $R_{G,SINK} = 0 \Omega$
- > N.B. In the considered measurements the load is the transistor with $R_{G,MOSFET} = 0.82 \Omega$, $R_{G,SINK} = 33 \Omega$, $C_{LOAD} \approx 2.8 \text{ nF}$

C_{LOAD} calculation for IPA60R099C7



Gate to drain charge	Q_{gd}	-	14	-	nC	$V_{DD}=400V, I_D=9.7A, V_{GS}=0 \text{ to } 10V$
Gate charge total	Q_g	-	42	-	nC	$V_{DD}=400V, I_D=9.7A, V_{GS}=0 \text{ to } 10V$

$$Q_{LOAD} = Q_g - Q_{gd} = 28 \text{ nC} \rightarrow C_{LOAD} = \frac{Q_{LOAD}}{V_{GS}} = 2.8 \text{ nF} \text{ for } V_{GS} = 10 \text{ V} \rightarrow$$

$$C_{LOAD} \approx 2.8 \text{ nF} \text{ for } V_{GS} = 12 \text{ V}$$

Rise/fall times

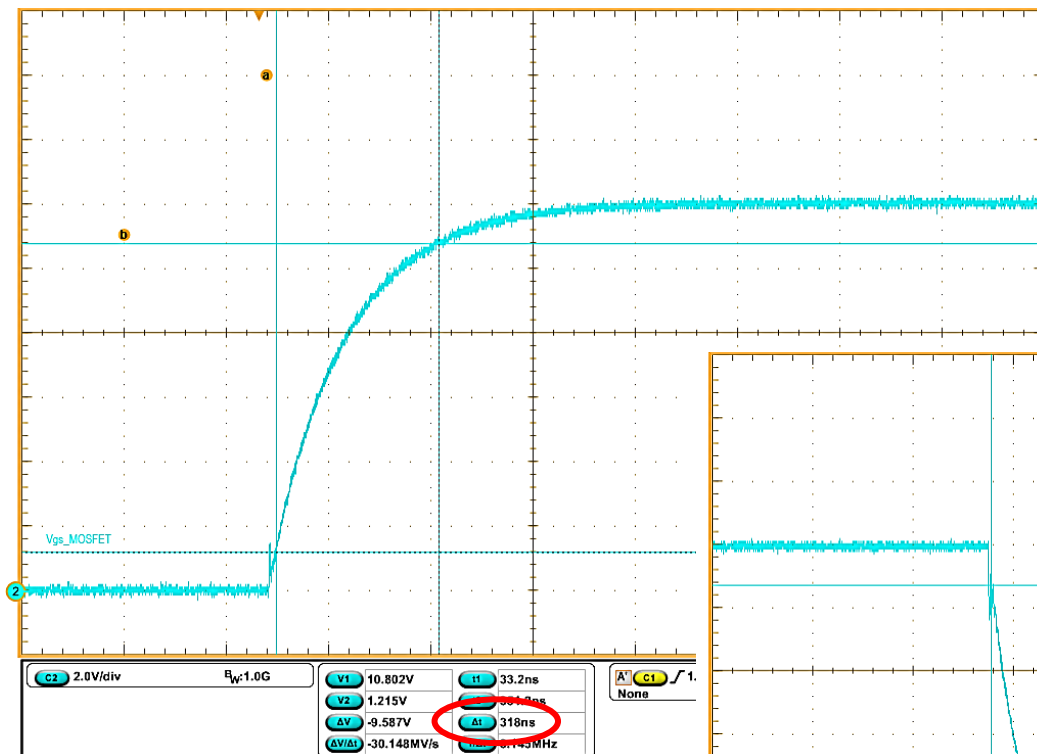

$$R_{G,SOURCE} = 39 \Omega$$

$$R_{G,SINK} = 33 \Omega$$

MOSFET = IPA60R099C7

$$R_{G,MOSFET} = 0.82 \Omega$$

$$C_{LOAD} \approx 2.8 \text{ nF}$$

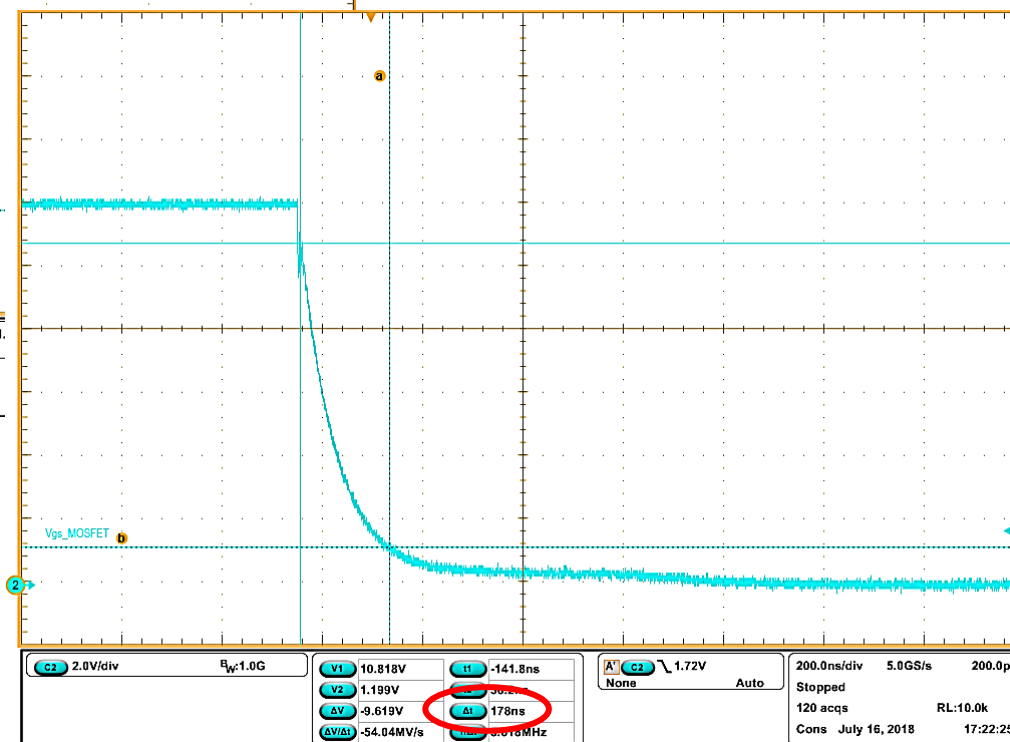

Gate resistors replacement

$$R_{G,SOURCE} = 39 \Omega \quad \rightarrow \quad 24 \Omega$$

$$R_{G,SINK} = 33 \Omega \quad \rightarrow \quad 20 \Omega$$

MOSFET = IPA60R099C7

Rise/fall times: New set of gate resistances

$$R_{G,SOURCE} = 24 \Omega$$

$$R_{G,SINK} = 20 \Omega$$

MOSFET = IPA60R099C7

$$R_{G,MOSFET} = 0.82 \Omega$$

$$C_{LOAD} \approx 2.8 \text{ nF}$$

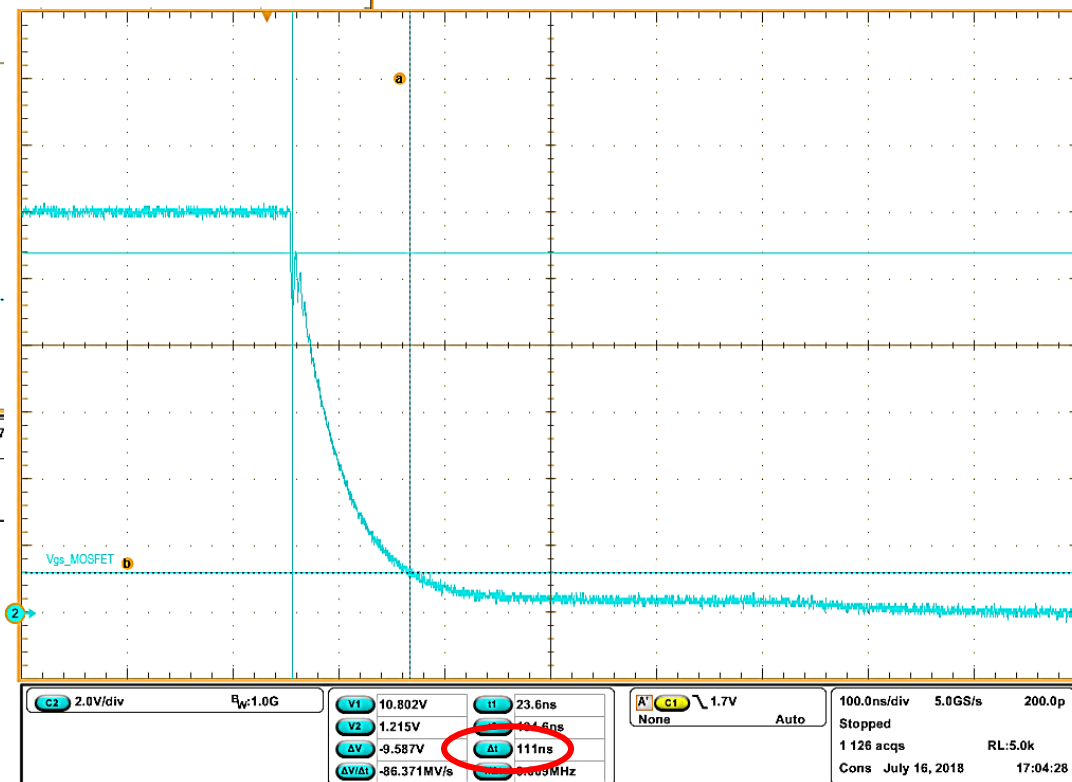
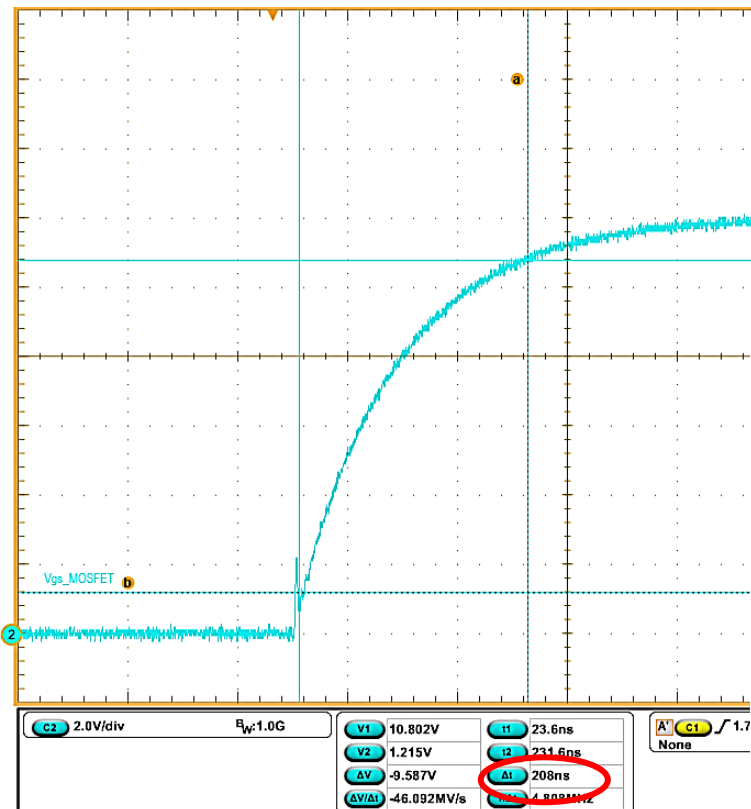

Gate resistors replacement

$$R_{G,SOURCE} = 24 \Omega \quad \rightarrow \quad 51 \Omega$$

$$R_{G,SINK} = 20 \Omega \quad \rightarrow \quad 43 \Omega$$

MOSFET = IPA60R099C7

Rise/fall times: New set of gate resistances

$$R_{G,SOURCE} = 51 \Omega$$

$$R_{G,SINK} = 43 \Omega$$

MOSFET =
IPA60R099C7

$$R_{G,MOSFET} = 0.82 \Omega$$

$$C_{LOAD} \approx 2.8 \text{ nF}$$

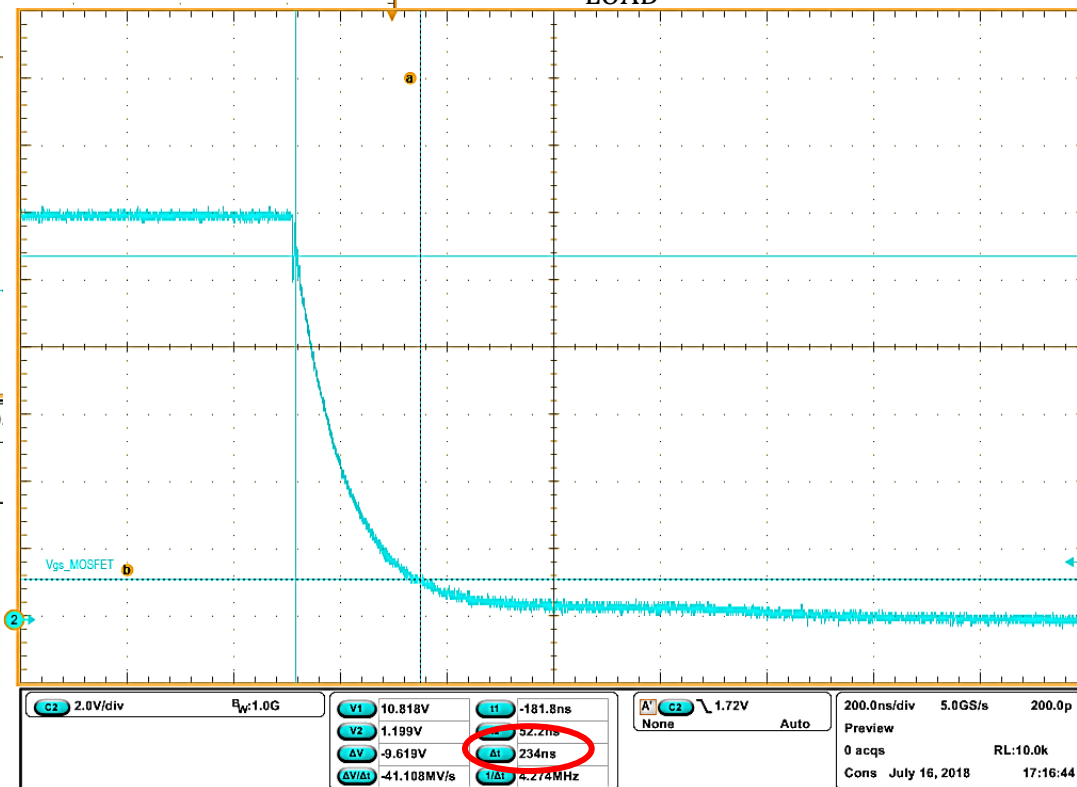
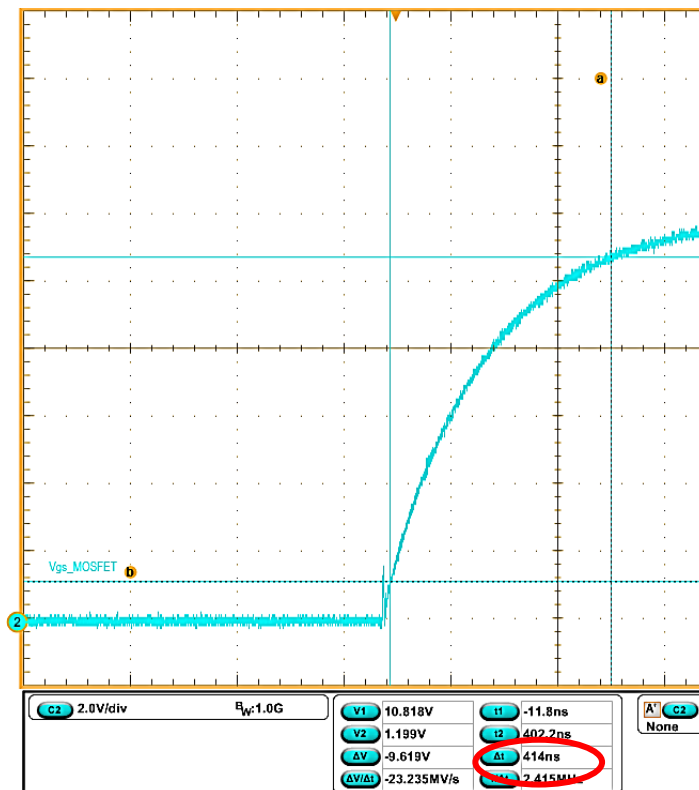

MOSFET Replacement

IPA60R099C7 → IPA60R280CFD7

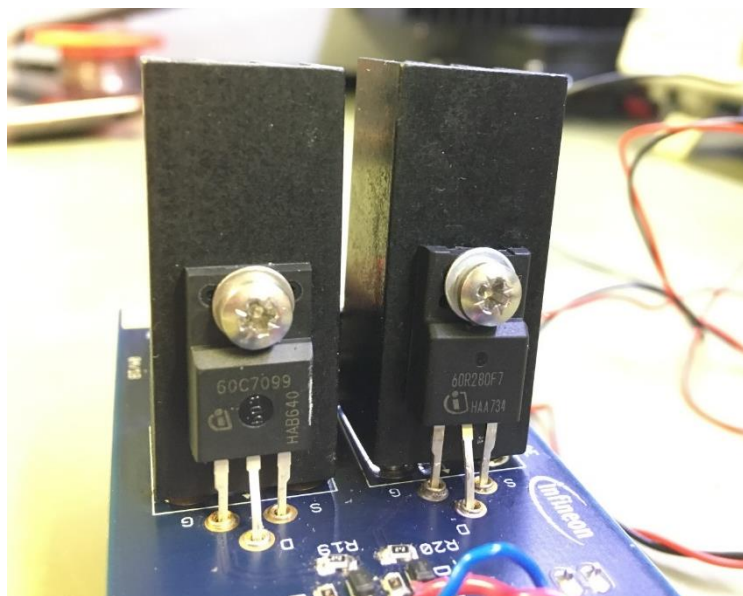

Gate to drain charge	Q_{gd}	-	5	-	nC	$V_{DD}=400V, I_D=5.0A, V_{GS}=0 \text{ to } 10V$
Gate charge total	Q_g	-	18	-	nC	$V_{DD}=400V, I_D=5.0A, V_{GS}=0 \text{ to } 10V$

$$C_{LOAD} \approx \frac{13 \text{ nC}}{10 \text{ V}} = 1.3 \text{ nF for } V_{GS} = 12 \text{ V}$$

Rise/fall times: New MOSFET

$R_{G,SOURCE} = 51 \Omega$
 $R_{G,SINK} = 43 \Omega$
 MOSFET =
IPA60R280CFD7
 $R_{G,MOSFET} = 11 \Omega$
 $C_{LOAD} \approx 1.3 \text{ nF}$

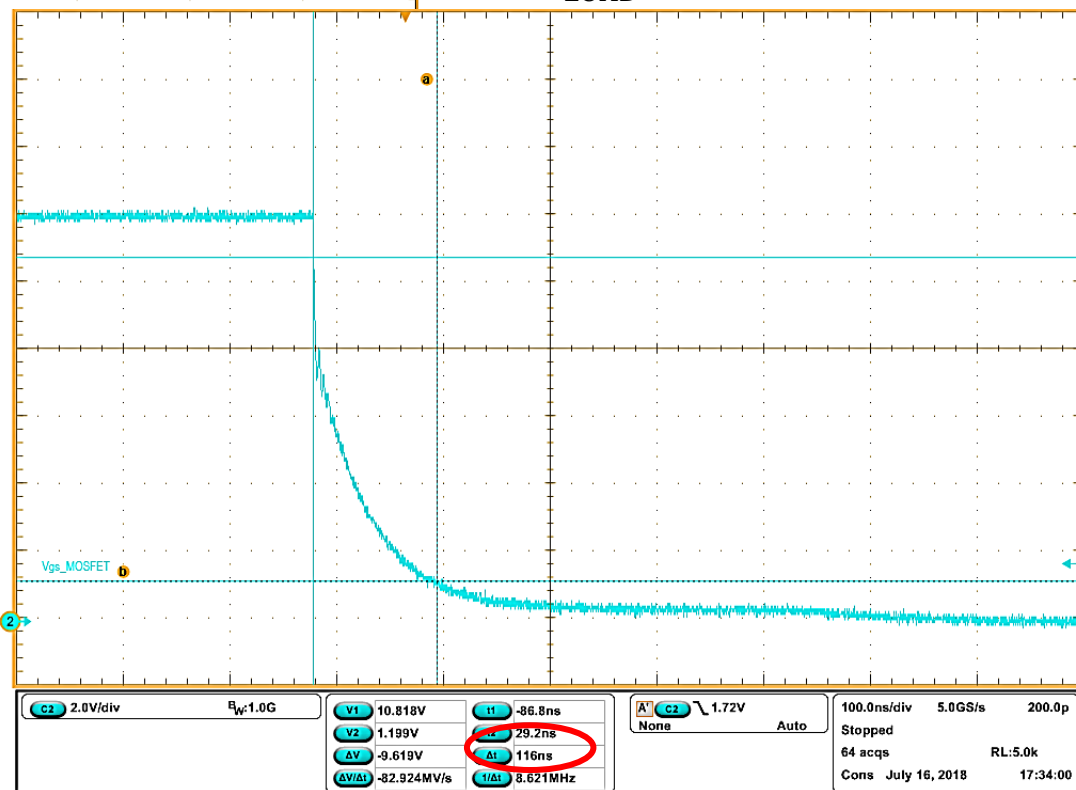
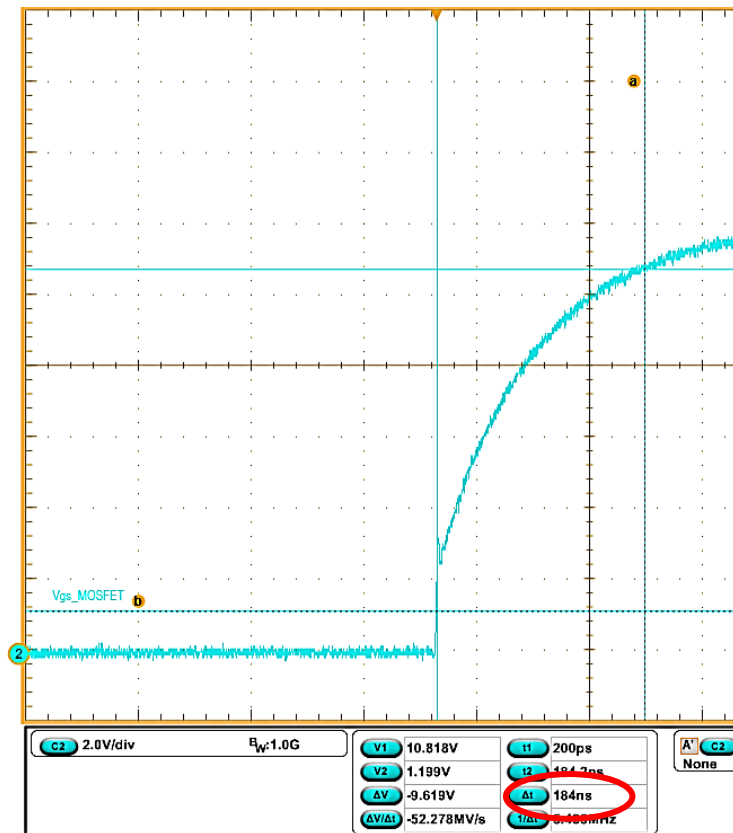

MOSFET replacement

IPA60R280CFD7 → IPA60R180P7

Gate to drain charge	Q_{gd}	-	8	-	nC	$V_{DD}=400V, I_D=5.6A, V_{GS}=0 \text{ to } 10V$
Gate charge total	Q_g	-	25	-	nC	$V_{DD}=400V, I_D=5.6A, V_{GS}=0 \text{ to } 10V$

$$C_{LOAD} \approx \frac{19 \text{ nC}}{10 \text{ V}} = 1.9 \text{ nF for } V_{GS} = 12 \text{ V}$$

Rise/fall times: New MOSFET

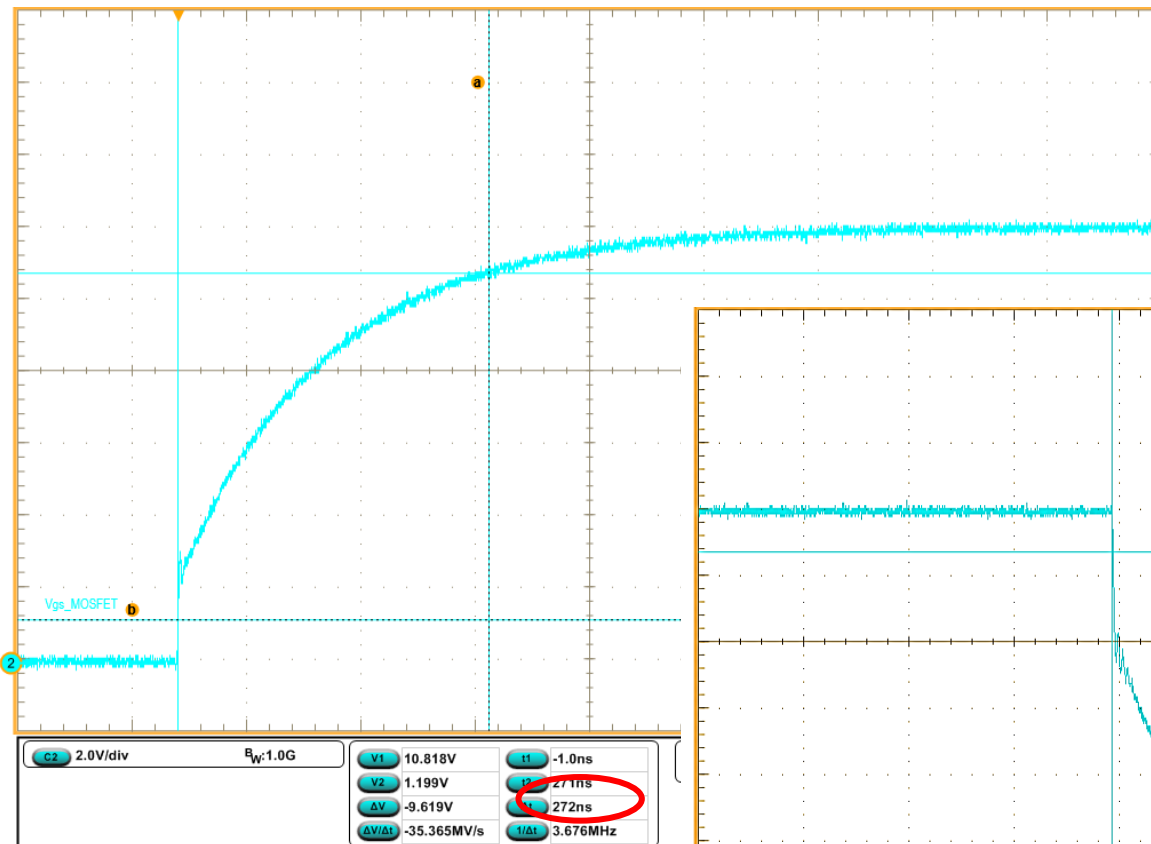

$R_{G,SOURCE} = 51 \Omega$
 $R_{G,SINK} = 43 \Omega$
MOSFET = IPA60R180P7
 $R_{G,MOSFET} = 11 \Omega$
 $C_{LOAD} \approx 1.9 \text{ nF}$

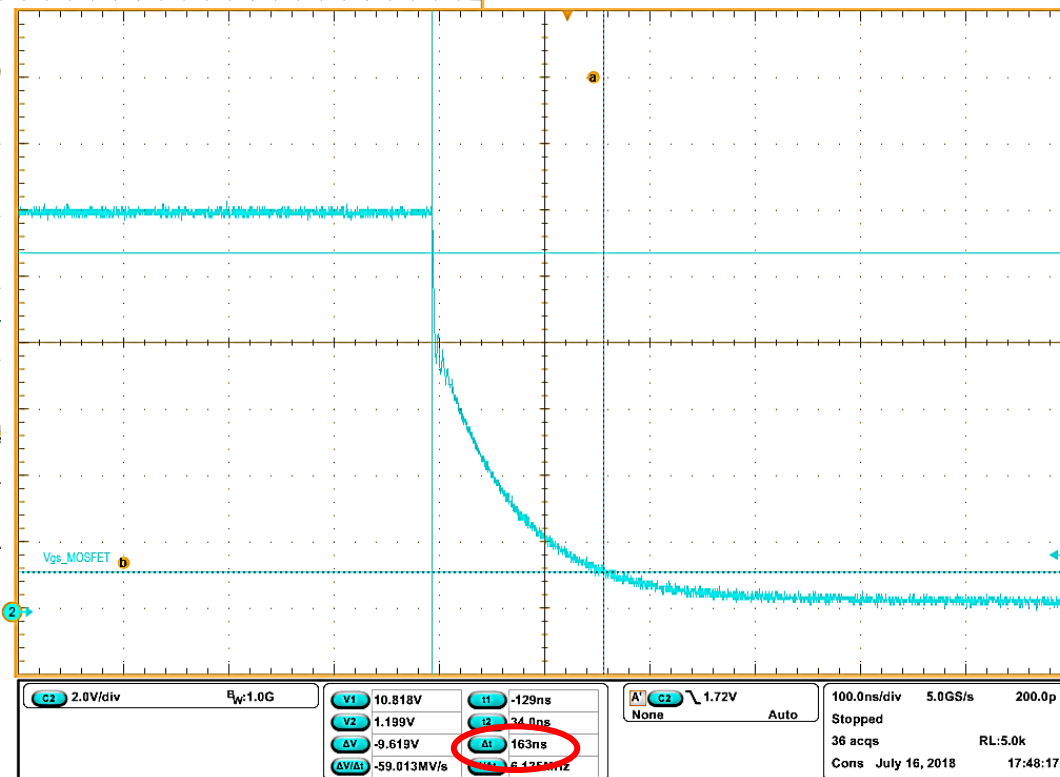

c2 2.0V/div		BW:1.0G	
V1 10.818V	t1 -1.0ns	V2 1.199V	t2 271ns
ΔV -9.619V	Δt 272ns	ΔV/Δt -35.365MV/s	f/Δt 3.676MHz

c2 2.0V/div		BW:1.0G		A' c2 \ 1.72V		100.0ns/div 5.0GS/s 200.0p	
V1 10.818V	t1 -129ns	V2 1.199V	t2 24.0ns	None Auto		Stopped	
ΔV -9.619V	Δt 163ns	ΔV/Δt -59.013MV/s	f/Δt 6.132MHz			38 acqs RL:5.0k	
						Cons July 16, 2018 17:48:17	

Additional notes

- > Note that the MOSFET is not turned-on or -off, you are only charging/discharging the gate-to-source capacitance
- > Changing the gate resistors and the MOSFETs, you are changing the load for the driver
- > If you want to turn-on or turn-off the MOSFET, you must integrate the board in a proper circuit
- > You can not apply directly the voltage (e.g 400 V) across the MOSFET through the banana connectors on the board
- > You must limit the input current from the DC source generator → add an inductance
- > You must create a freewheeling path for the current when MOSFET is off

Example: boost converter, simple MOSFET in clamped inductive mode

IMPORTANT NOTICE and WARNINGS

IMPORTANT NOTICE

The information given in this document shall in no event be regarded as a guarantee of conditions or characteristics ("Beschaffenhheitsgarantie").

With respect to any examples, hints or any typical values stated herein and/or any information regarding the application of the product, Infineon Technologies hereby disclaims any and all warranties and liabilities of any kind, including without limitation warranties of non-infringement of intellectual property rights of any third party.

In addition, any information given in this document is subject to customer's compliance with its obligations stated in this document and any applicable legal requirements, norms and standards concerning customer's products and any use of the product of Infineon Technologies in customer's applications.

The data contained in this document is exclusively intended for technically trained staff. It is the responsibility of customer's technical departments to evaluate the suitability of the product for the intended application and the completeness of the product information given in this document with respect to such application. For further information on the product, technology, delivery terms and conditions and prices please contact your nearest Infineon Technologies office (www.infineon.com).

WARNINGS

Due to technical requirements products may contain dangerous substances. For information on the types in question please contact your nearest Infineon Technologies office.

Except as otherwise explicitly approved by Infineon Technologies in a written document signed by authorized representatives of Infineon Technologies, Infineon Technologies' products may not be used in any applications where a failure of the product or any consequences of the use thereof can reasonably be expected to result in personal injury.



Part of your life. Part of tomorrow.

