

Design-in guidelines for XENSIV™ PAS CO2

About this document

This application note provides design guidelines to the final application owners for optimizing the environmental and mechanical integration of Infineon’s XENSIV™ PAS CO2 sensor.

Scope and purpose

This document provides information on the environmental and mechanical implementation of Infineon’s XENSIV™ PAS CO2 sensor. It also highlights recommended application scenarios for the sensor.

Intended audience

Product development teams considering using the state-of-the-art miniature CO₂ sensor, XENSIV™ PAS CO2, in their applications.

Table of contents

About this document	1
Table of contents	1
1 Introduction to XENSIV™ PAS CO2 module	2
2 Working principles of XENSIV™ PAS CO2	3
3 Recommendations to ensure ideal operation	4
3.1 Proper coupling with the ambient conditions	4
3.2 Several preventive measures should be considered	4
3.3 Minimize noise in 12 V supply line	6
4 Typical application scenarios	7
4.1 Influence of acoustic signal within a speaker	7
4.2 Influence of vibration within an air purifier.....	7
4.3 Sensor coverage within an indoor environment.....	8
4.3.1 Application scenario: Meeting room	8
Revision history	10

1 Introduction to XENSIV™ PAS CO2 module

As shown in Figure 1, XENSIV™ PAS CO2 comprises a gas measuring cell with an infrared (IR) emitter, a high-SNR microphone as the acoustic detector, and an XMC™ microcontroller for data processing. The diffuser port on the top side of the measuring cell allows for efficient gas exchange while maintaining dust protection. The sensor module allows for integration via surface mount soldering via the pads on the bottom side of its PCB. All the key components are developed in-house, ensuring the highest quality and performance. However, proper implementation of the sensor in the application environment is essential to achieve the best sensor performance.

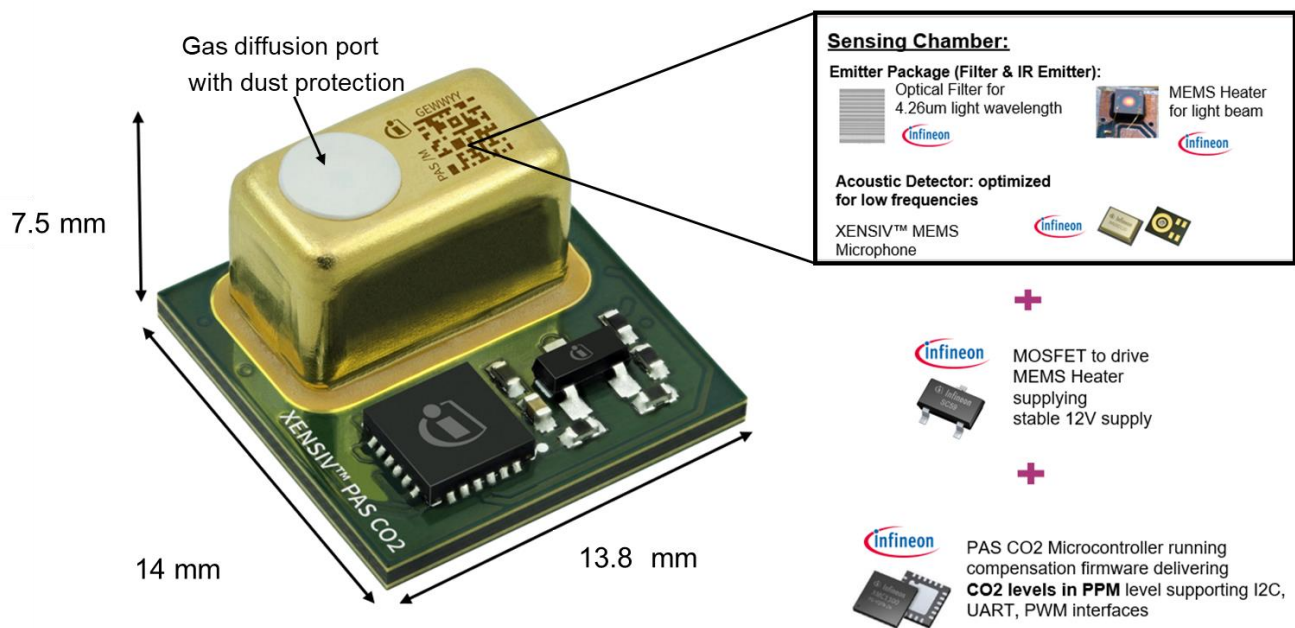

Figure 1 All the key components of XENSIV™ PAS CO2 are developed in-house to ensure best-in-class quality of the sensor

2 Working principles of XENSIV™ PAS CO2

Before the recommendations, here is a recap of the working principles of photoacoustic spectroscopy (PAS). As shown in Figure 2, the emitter IR light source (black body radiator) emits a wide spectrum, and the optical filter only allows 4.2 μm wavelength. CO₂ molecules inside the chamber absorb light at 4.2 μm wavelength and are excited. The IR emitter needs to be chopped at a certain frequency to ensure the CO₂ molecules create enough acoustic pressure change inside the cavity, which is then detected by the acoustic detector at the resonance frequency.

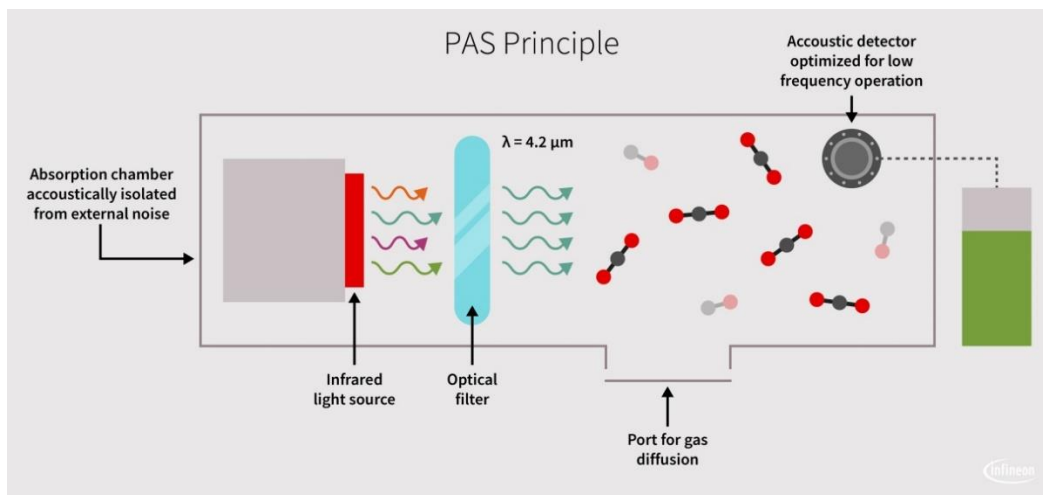

Figure 2 Working principles of photo acoustic spectroscopy

Three essential building blocks dictate if the sensor will perform well or not in the application environment:

- **Building block 1:** Proper CO₂ molecule diffusion via the gas port
- **Building block 2:** Selective 4.2 μm light from the emitter
- **Building block 3:** Acoustic pressure change only due to CO₂ molecule excitation is detected by the microphone

In the following section, these three building blocks will be addressed with proper recommendations to ensure good performance of the sensor in the application system.

3 Recommendations to ensure ideal operation

3.1 Proper coupling with the ambient conditions

As discussed in the previous section, for proper operation the CO₂ molecules need to be diffused properly within the sensor cavity. To ensure proper coupling, the following conditions must be met:

- The device needs to be positioned in such a way that the diffusion of CO₂ molecules can happen easily, with a large enough opening. The recommended opening is at least 14 mm x 14 mm.
- CO₂ concentration should not be trapped inside the application chamber cavity. The back volume of the application chamber cavity should be around 3.89 cm³ (1.8 cm x 1.8 cm x 1.2 cm).

An example of a good environmental coupling is shown in Figure 3.

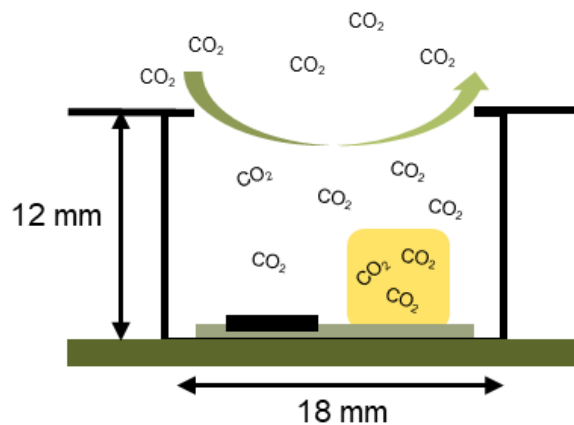

Figure 3 Example of ideal coupling with the ambient conditions

3.2 Several preventive measures should be considered

In addition to good coupling with the environment, the following preventive measure should also be considered.

- **Protection from direct air flow:** The sensor should not be placed directly in the flow. Depending on the flow, the pressure within the application cavity might alter, which could introduce additional errors due to random pressure variation.
- **Isolation from a temperature source:** Within the operating range of 0°C to 50°C, the XENSIV™ PAS CO₂ sensor largely compensates for the impact of temperature. The built-in XMC™ temperature sensor is used for this compensation. However, if there is a heat source next to the sensor, the device will not experience the ambient temperature, rather it will only consider the board temperature. Therefore, the compensation scheme might be disturbed if the heat source influences the temperature measurement by the XMC™. Consequently, for ideal operating conditions, it is recommended that the sensor remains isolated from adjacent heat sources.
- **Isolation from vibration:** The detector of the PAS technology is a MEMS microphone, which quantifies small pressure changes within the gas cavity. Low-frequency vibrations may create similar pressure change and the sensor may consider this small pressure change as the real CO₂ concentration change. Therefore, it is recommended to ensure that the sensor remains isolated from a direct vibration source. However, if it will not be possible to ensure vibration isolation, it is recommended to identify the vibration source first and position the sensor in such a way that the vibration comes from the x-direction of the sensor, as shown in

Recommendations to ensure ideal operation

Figure 4. Additionally, during continuous mode and fast sampling rate operation it is recommended to enable the denoiser filter (stepwise reactive IIR), which further minimizes the impact of vibrations.

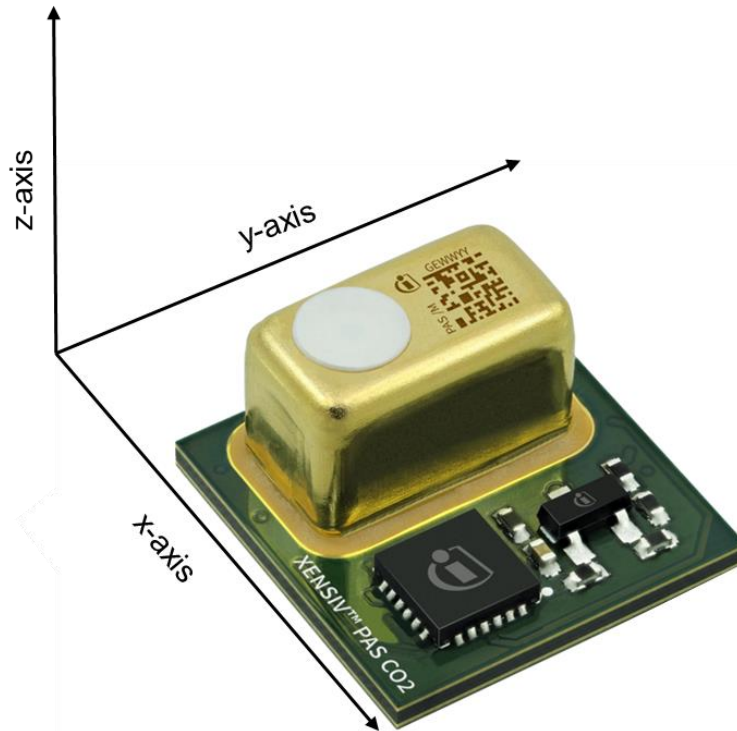

Figure 4 The sensor should be placed in the x-direction of the vibration source

- **Isolation from sunlight:** If the sensor is exposed to sunlight, it may heat up and create a temperature gradient. This temperature gradient may block proper temperature compensation by the sensor, and therefore it is recommended to isolate the sensor from sunlight.
- **Non-condensing operation:** The device must be used for non-condensing operation only. Water accumulation near the circuitry may damage the sensor irreparably.

An ideal chamber design incorporating the preventive measures mentioned is shown in Figure 5.

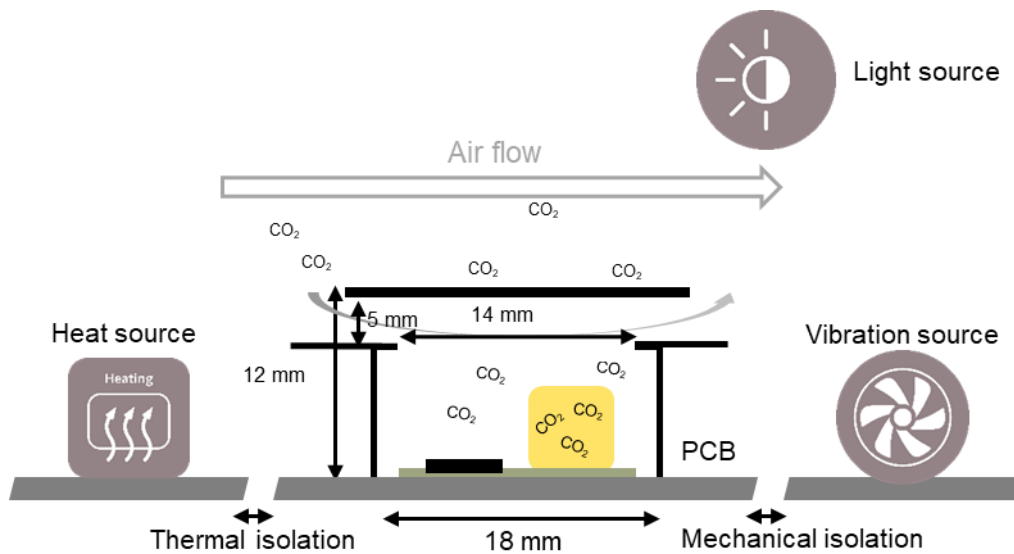

Figure 5 Preventive measures should be considered when designing the application using XENSIV™ PAS CO2

3.3 Minimize noise in 12 V supply line

To minimize the noise in the 12 V supply line, a set of decoupling capacitors should be used. Decoupling capacitors act as local electrical energy storage and need time to charge or discharge. Therefore, they oppose quick voltage changes and only pass through the DC component of the signal. As a recommendation, as shown in Figure 6, 47 μF , 100 nF and 10nF should be connected between 12 V and GND to cover a wide noise spectrum in the 12 V line and should be placed as close as possible to the VDD12 pin. Generally, the sensor is robust against supply noise and ripple. The supply can be prepared with cost-efficient components as shown in Figure 6. An example circuit to generate 12 V is shared as a reference design in the download section of the product page (www.infineon.com/CO2).

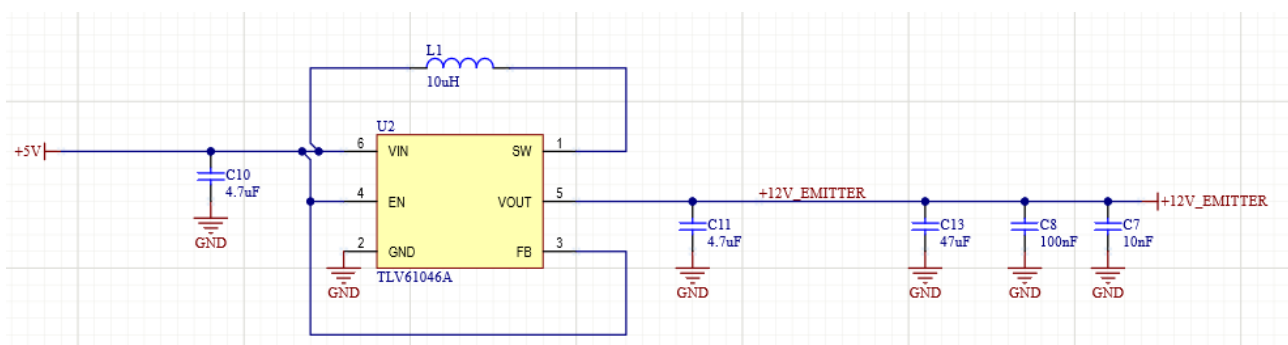

Figure 6 Recommended circuit to decouple 12 V supply voltage

4 Typical application scenarios

4.1 Influence of acoustic signal within a speaker

PAS technology relies on a high SNR microphone to detect CO2. Therefore, it is a general concern for an end-user that, the sensor might be impacted by ambient noise. However, thanks to our robust package, the sensor is acoustically isolated from surrounding noise. The sensor has been designed in such a way, that only CO2 molecules can diffuse within the measurement chamber, while significantly attenuate the surrounding noise. As shown in Figure 7, any position fulfilling the previously discussed prevention recommendation should be sufficient to ensure ideal sensor performance within a speaker. A test has been conducted with the following condition:

- **Ambient condition:** Temperature 25°C, Relative humidity 50%, Pressure 960 hPa
- **Noise level:** Pink noise sweep from 83 dB to 101dB SPL (Sound Pressure Level)

The sensor remained within the specification for the test condition at four different positions of the speaker within the denoise filter enabled.

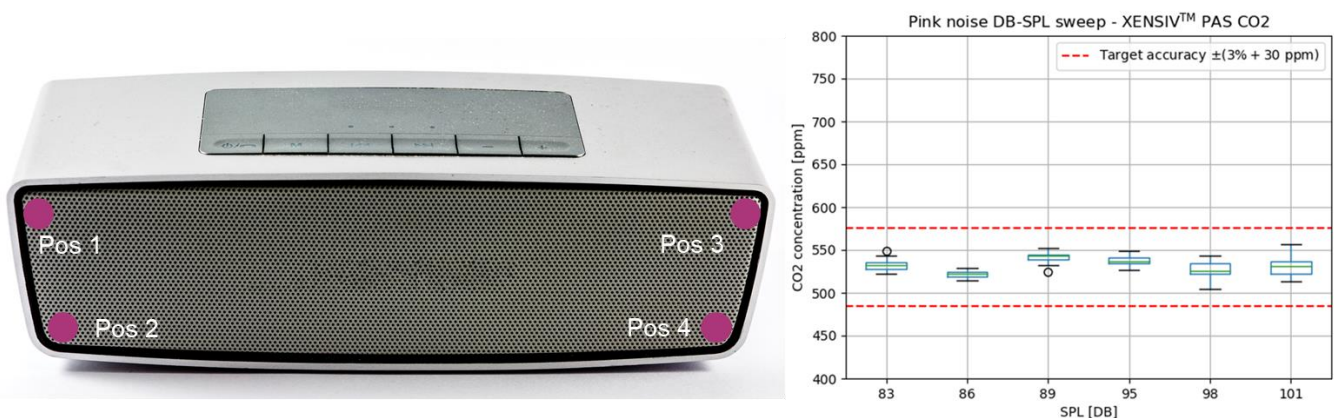

Figure 7 Acoustic robustness of XENSIV™ PAS CO2

Pink noise is widely present within modern-day music and typically the frequency band is 100 Hz to 10000 Hz. For an analogy, at a subway station or in a disco bar 1m away from the speaker the sound pressure level may reach up to 100 dB. XENSIV™ PAS CO2 sensor output is well within specification even at such a high sound pressure level.

4.2 Influence of vibration within an air purifier

It is strongly recommended to isolate the sensor from a vibration source. However, vibration associated with a typical application scenario may not be critical. As shown in Figure 8, three sensors were mounted on an air purifier commercially available in the market. The test result shows that with the denoiser filter enabled, the sensor is robust against the vibration generated at a different fan of the air purifier.

Typical application scenarios

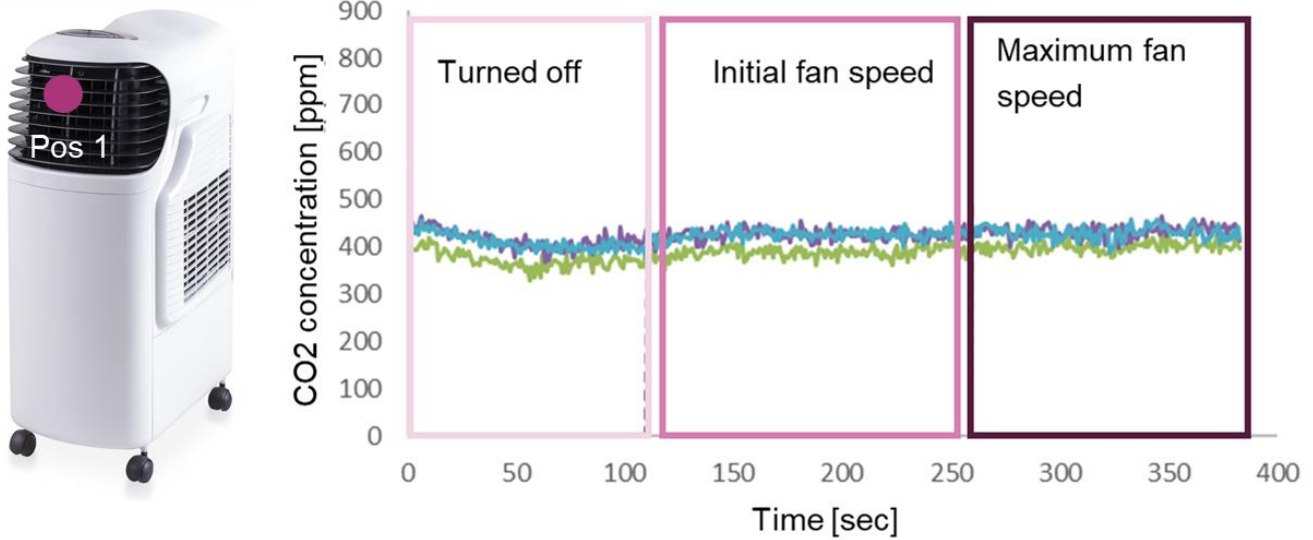

Figure 8 Vibration robustness of XENSIV™ PAS CO2

4.3 Sensor coverage within an indoor environment

Simulation result shows, irrespective to the room size, number of people or sensor location, one sensor is sufficient to cover a complete room.

4.3.1 Application scenario: Meeting room

• Scenario:

- Six adults sitting in a meeting room (30 m²)
- CO2 concentration is monitored at 3 different locations, i.e. the floor (Probe 1), the wall (Probe 2), and the ceiling (Probe 3)

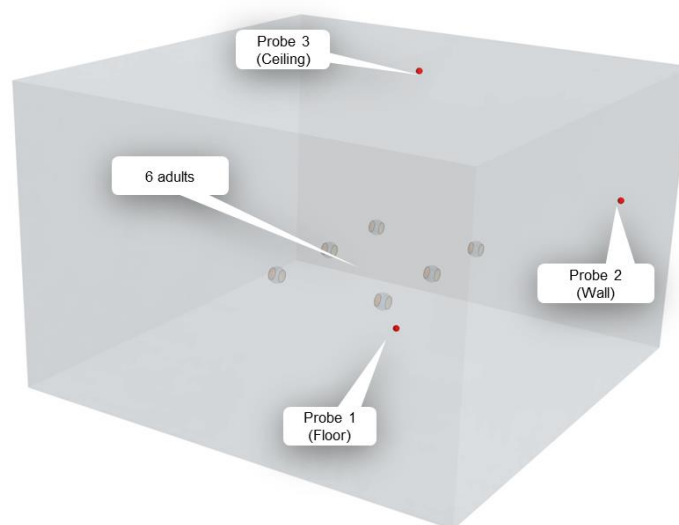

Figure 9 Typical meeting room in an office environment

- **Assumption:**
 - Air volume exhale per human: 8 l/min
 - CO2 emission per adult: 900 g/d
 - Heat emission per human: 60 W
 - Poor ventilation system
- **Result:** Among different probe locations, no significant difference in CO2 concentration is observed.

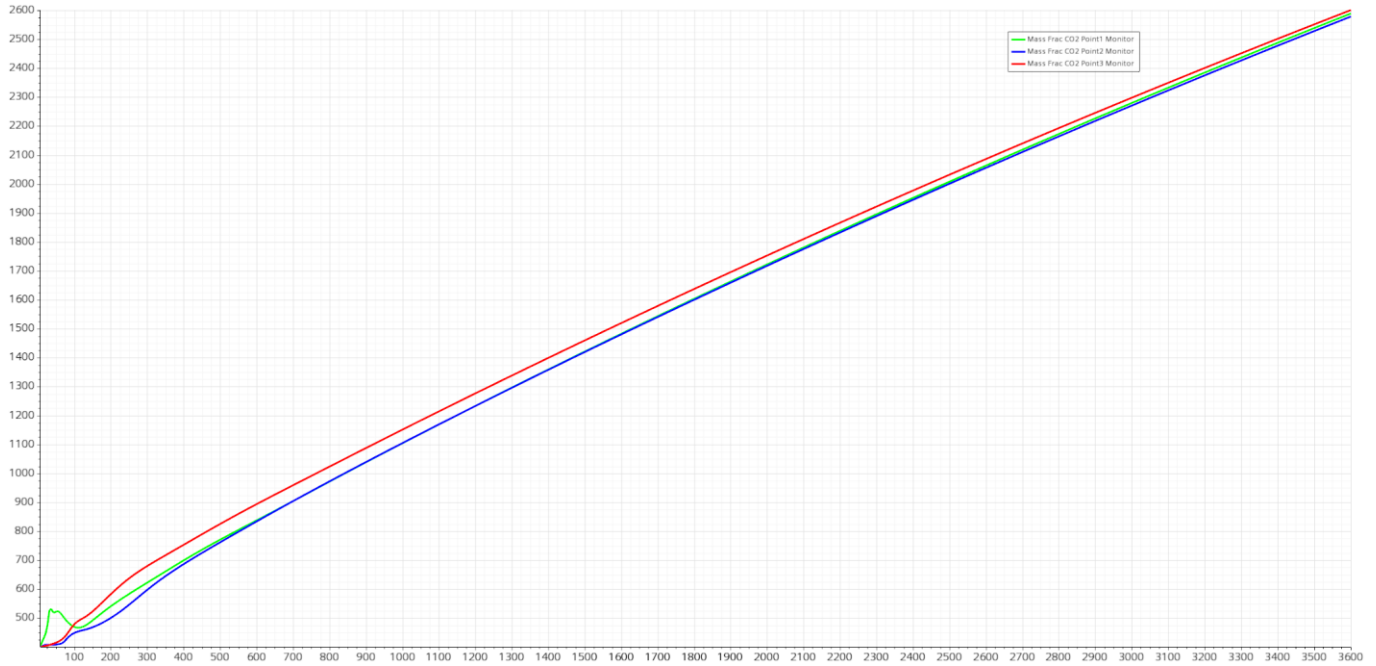

Figure 10 CO2 level at different probe location within a 30 m² meeting room



Revision history

Document version	Date of release	Description of changes
V1.0	11.06.2021	Creation

Trademarks

All referenced product or service names and trademarks are the property of their respective owners.

Published by

Infineon Technologies AG

81726 Munich, Germany

© 2021 Infineon Technologies AG.

All Rights Reserved.

Do you have a question about this document?

Email: erratum@infineon.com

DG_2106_PL38_2107_131711

IMPORTANT NOTICE

The information contained in this application note is given as a hint for the implementation of the product only and shall in no event be regarded as a description or warranty of a certain functionality, condition or quality of the product. Before implementation of the product, the recipient of this application note must verify any function and other technical information given herein in the real application. Infineon Technologies hereby disclaims any and all warranties and liabilities of any kind (including without limitation warranties of non-infringement of intellectual property rights of any third party) with respect to any and all information given in this application note.

The data contained in this document is exclusively intended for technically trained staff. It is the responsibility of customer's technical departments to evaluate the suitability of the product for the intended application and the completeness of the product information given in this document with respect to such application.

For further information on the product, technology, delivery terms and conditions and prices please contact your nearest Infineon Technologies office (www.infineon.com).

WARNINGS

Due to technical requirements products may contain dangerous substances. For information on the types in question please contact your nearest Infineon Technologies office.

Except as otherwise explicitly approved by Infineon Technologies in a written document signed by authorized representatives of Infineon Technologies, Infineon Technologies' products may not be used in any applications where a failure of the product or any consequences of the use thereof can reasonably be expected to result in personal injury.