

# XMC1000 / XMC4000 Motor Control Application Kit

Getting Started 01 v1.0

**Induction Motor V/F Control App**  
(ACIM\_FREQ\_CTRL)



# Induction Motor V/F Control App

1 Motor Control Application Kit Composition

2 Development Tool: DAVE™ version 4

3 Example: PMSM Motor with fixed speed

4 Example: PMSM Motor with adjustable speed

5 Additional information

# Induction Motor V/F Control App

1 Motor Control Application Kit Composition

2 Development Tool: DAVE™ version 4

3 Example: PMSM Motor with fixed speed

4 Example: PMSM Motor with adjustable speed

5 Additional information

# Kit composition – XMC 1300 Boot Kit

> Included in  
KIT\_XMC1X\_AK\_MOTOR\_001

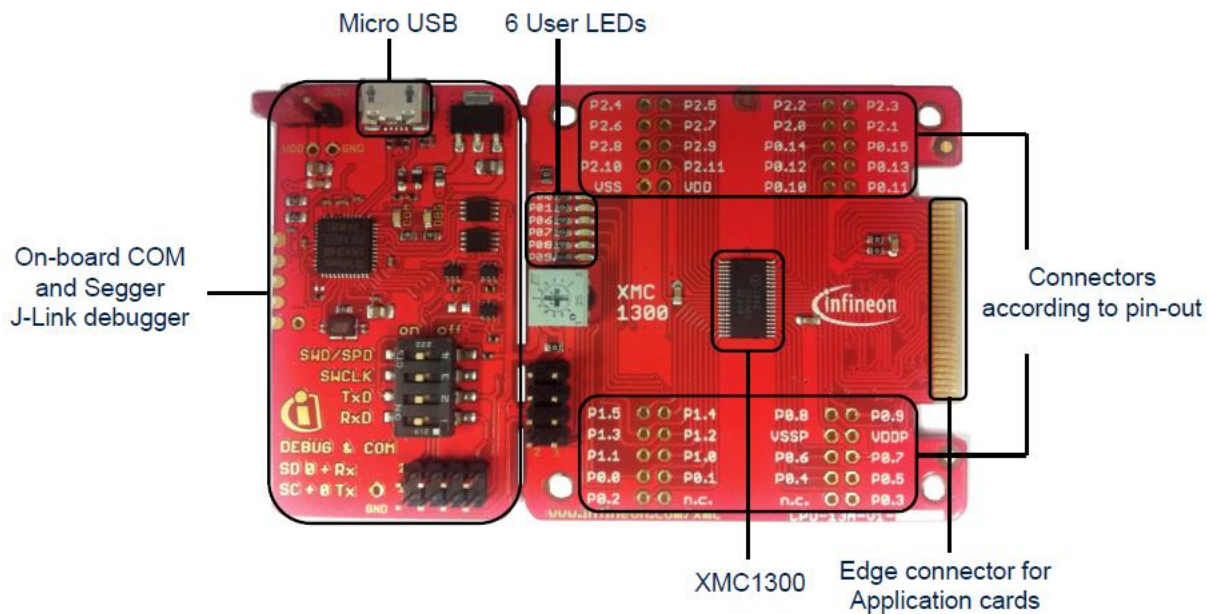

# Kit composition – PMSM LV 15W Card

> Included in  
KIT\_XMC1X\_AK\_MOTOR\_001

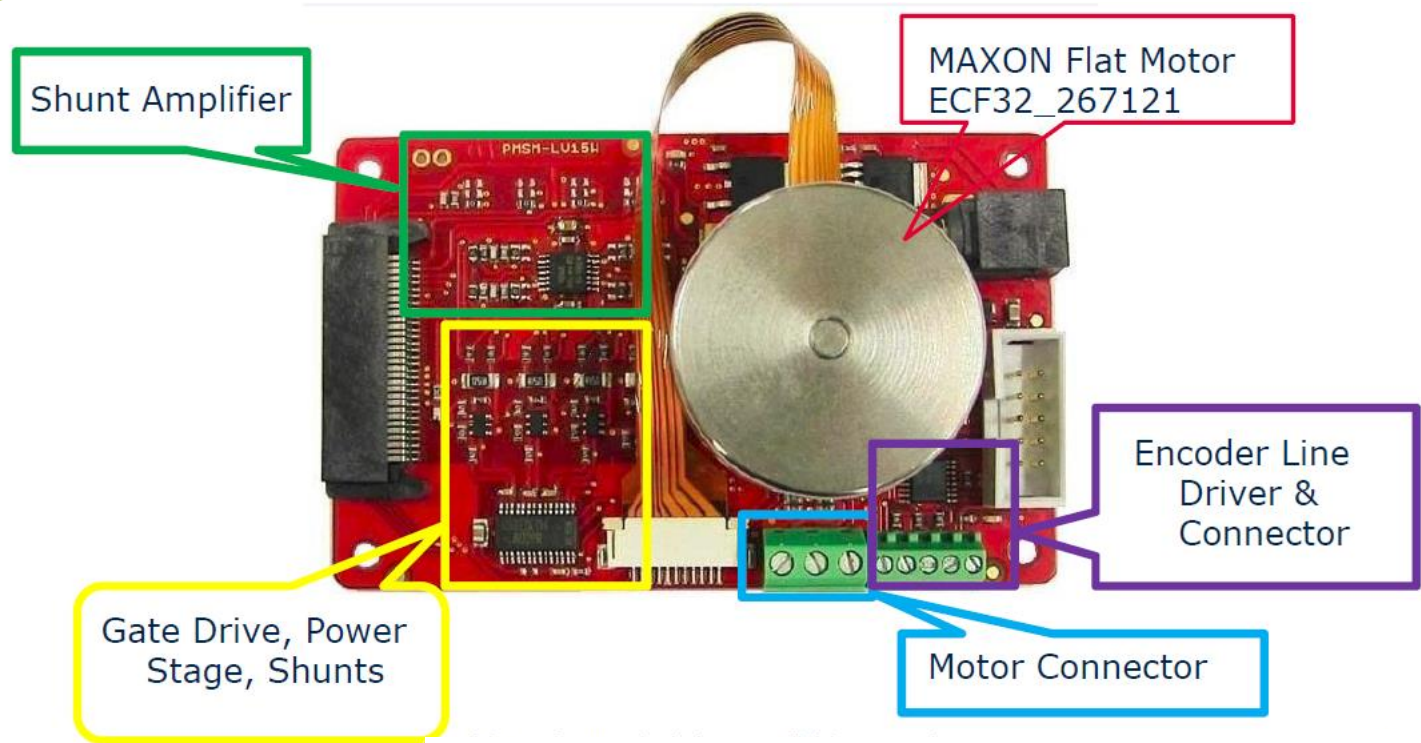

# Kit composition – connection **XMC1300**

KIT\_XMC1X\_AK\_MOTOR\_001

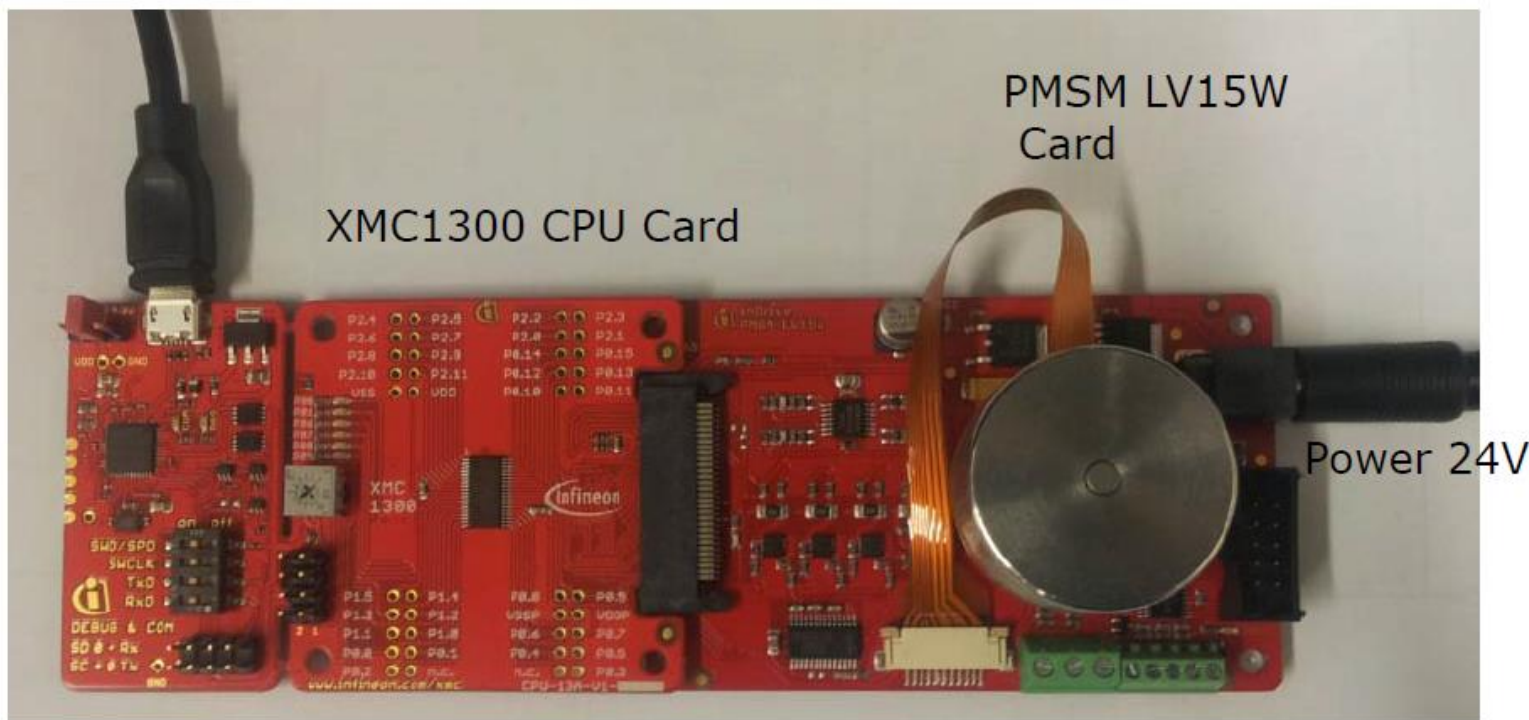

# Kit composition – XMC4400 Enterprise Kit

> Included in  
KIT\_XMC44\_AE3\_001

> Micro USB for  
Debug

> ACT connector  
for MOT\_GPDVL  
satellite

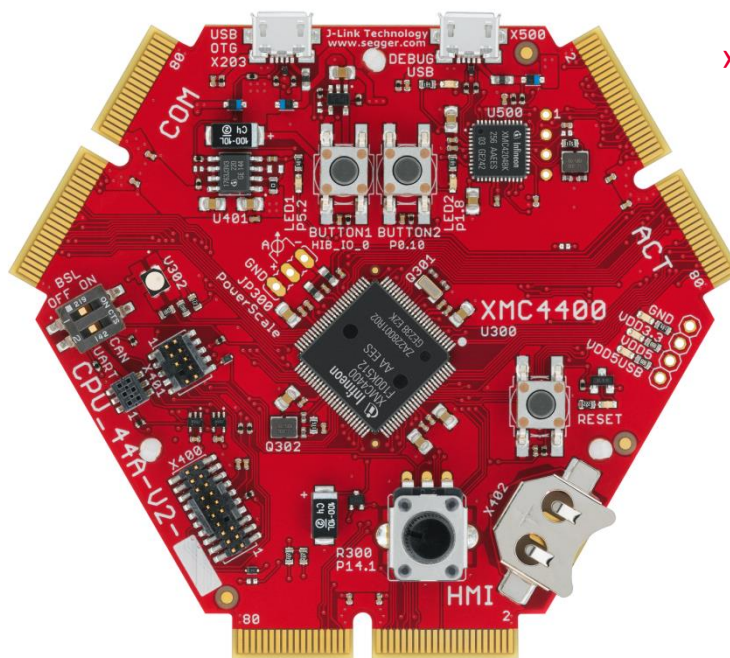

# Kit composition – General Purpose Motor Drive

> Included in  
KIT\_XMC44\_AE3\_001

Encoder input (white)  
Hall input (green)

Resolver input

Motor connector

24V power supply

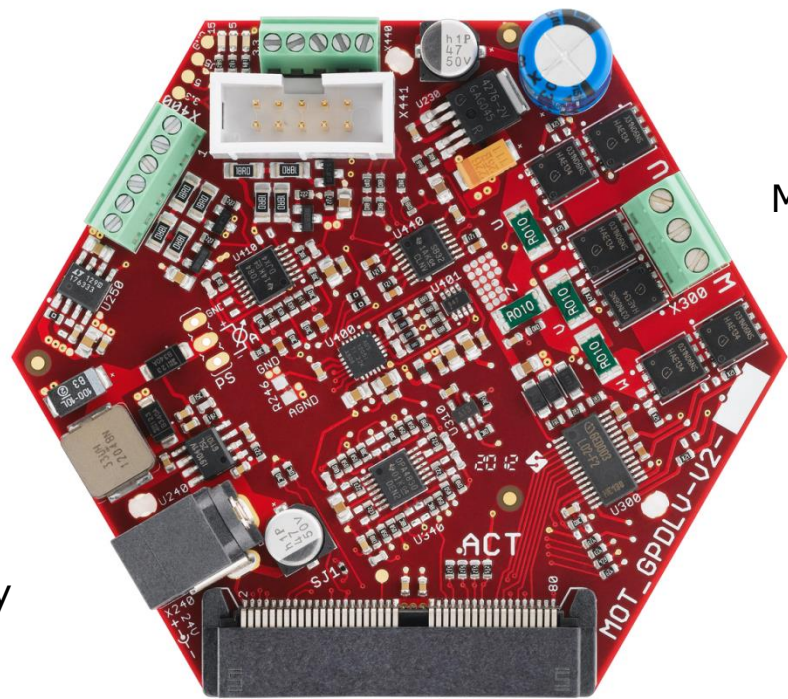

ACT connector to CPU Card  
(e.g. CPU\_44A)



# Kit composition – connection **XMC4400**

KIT\_XMC44\_AE3\_001

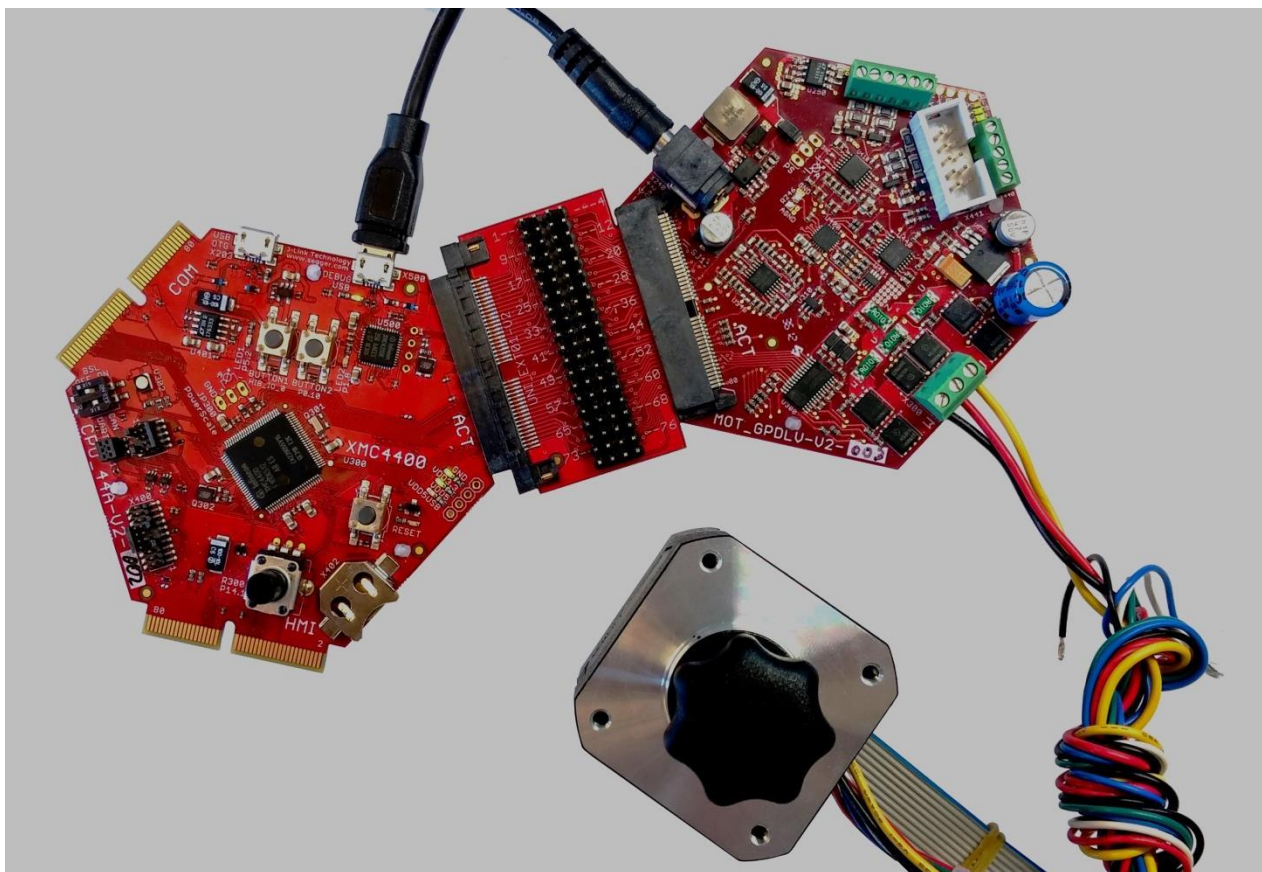

# Induction Motor V/F Control App

1 Motor Control Application Kit Composition

2 Development Tool: DAVE™ version 4

3 Example: PMSM Motor with fixed speed

4 Example: PMSM Motor with adjustable speed

5 Additional information

# Development Tool: DAVE™ version 4

- › DAVE™ is a free development platform for code generation by Infineon
- › The Software package: DAVE™ , Examples, Videos, Apps, XMCLib... can be downloaded from
- › <http://www.infineon.com/DAVE>
- › This Getting started is based on DAVE™ v. 4.1.2



# Induction Motor V/F Control App

1 Motor Control Application Kit Composition

2 Development Tool: DAVE™ version 4

3 Example: PMSM Motor with fixed speed

4 Example: PMSM Motor with adjustable speed

5 Additional information

# Getting started limitations

- › The following example shows the default usage of the App.
- › This Getting Started shows how to create an example with the default settings. Only the used App configurations are described. More information about the spectrum of the App can be found in the Help or an Application Note.
- › The creation is described in steps. If a step is specific to XMC1300 or XMC4400 it is mentioned in the title and a sub-step e.g. 2.a, 2.b. Variation of the example (e.g. with adjustable speed) based on the main example.
- › The following examples based on ACIM\_FREQ\_CTRL/ACIM\_FREQ\_CTRL APP v. 4.0.5 **beta**

# Step 1: create new project

- > Open Dave
- > Select a workspace or use the default workspace
- > Click "OK"
- > File → New → DAVE Project...

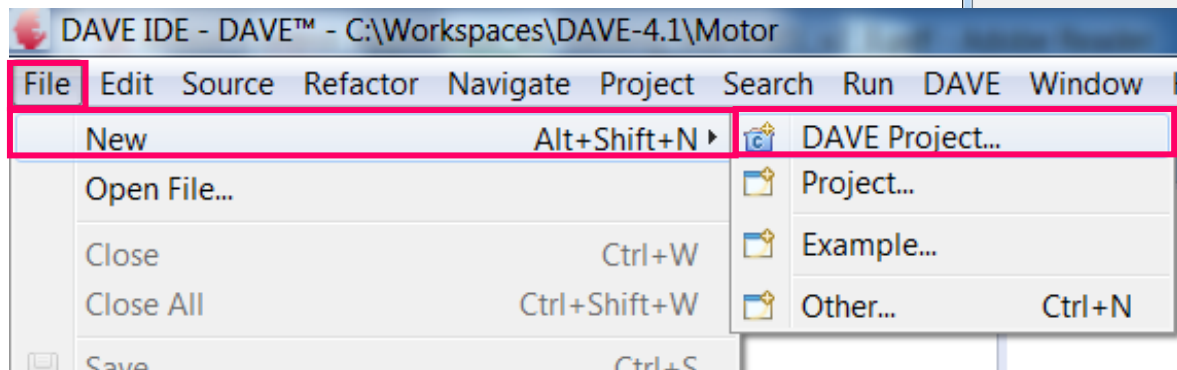
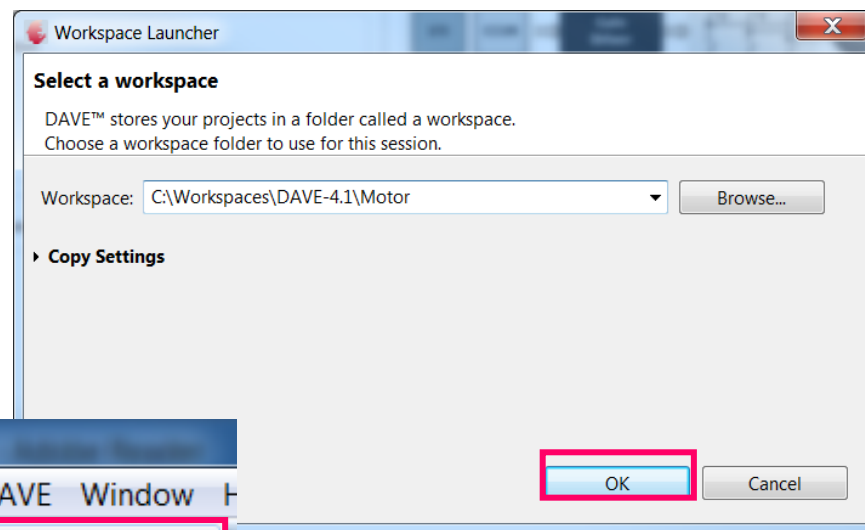

# Step 1: create new project

- › Enter project name: e.g. GT\_ACIM\_XMC44\_Example1\_v1\_0
- › Select "DAVE CE Project" for Project Type
- › Click "Next >"
- › Select your microcontroller:
  - **XMC1300**: XMC1302-TO38X0200
  - **XMC4400**: XMC4400-F100x512
- › Click "Finish"

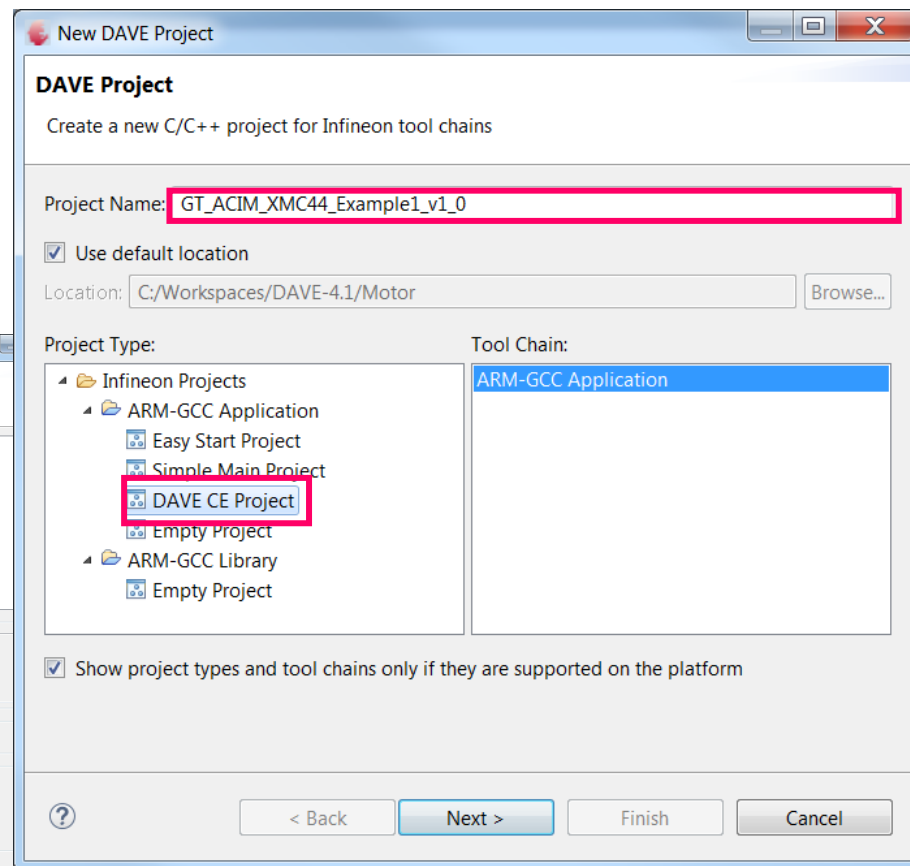
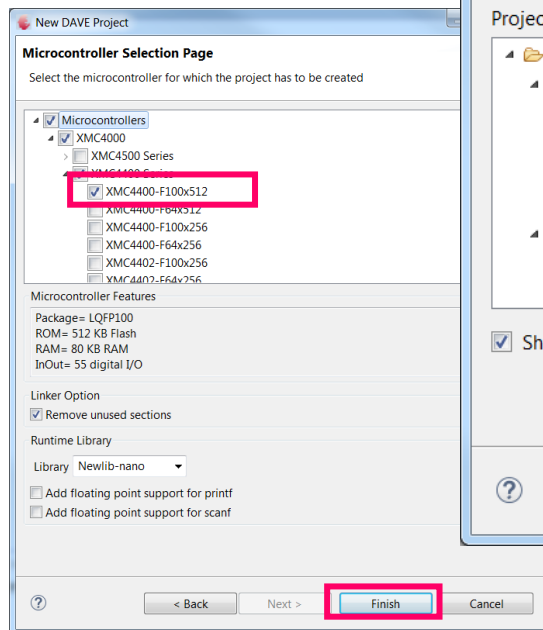

# Step 2: add APP

- › Click "Add New App" 
- › Deactivate "Hide beta versions"
- › Enter in search filter "Motor Control"
- › Select "ACIM\_FREQ\_CTRL"
- › Click "Add"
- › Read the warning regarding beta versions and Click "OK" to confirm.
- Add in a new APP takes a few seconds
- › Click "Close" to hide the "Add new APP" window

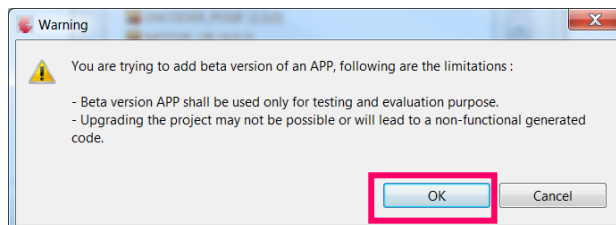
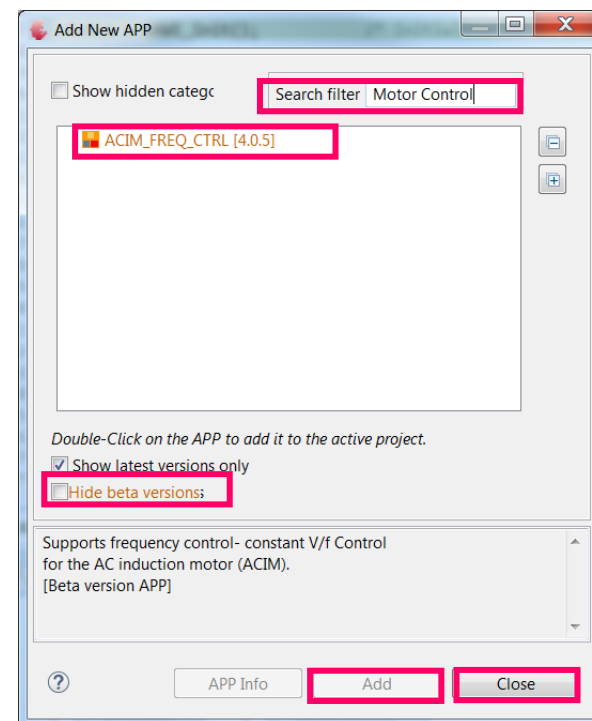
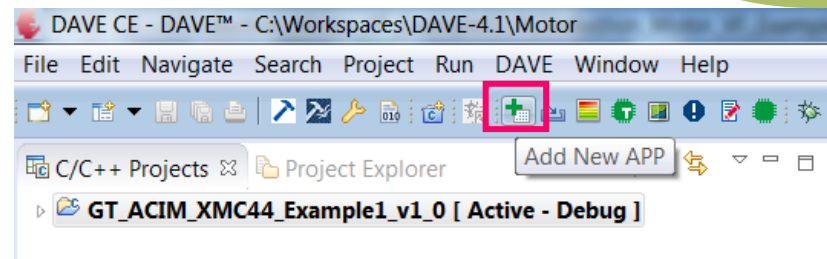



# Step 3: APP configuration

- › Open "ACIM\_FREQ\_CTRL" by double click or right click → "Configure App instance"
- › Open "Basic Control Scheme" **tab**
- › Select "FB\_RAMP\_0"
- This will add the AUTOMATION APP. This can take a few seconds.

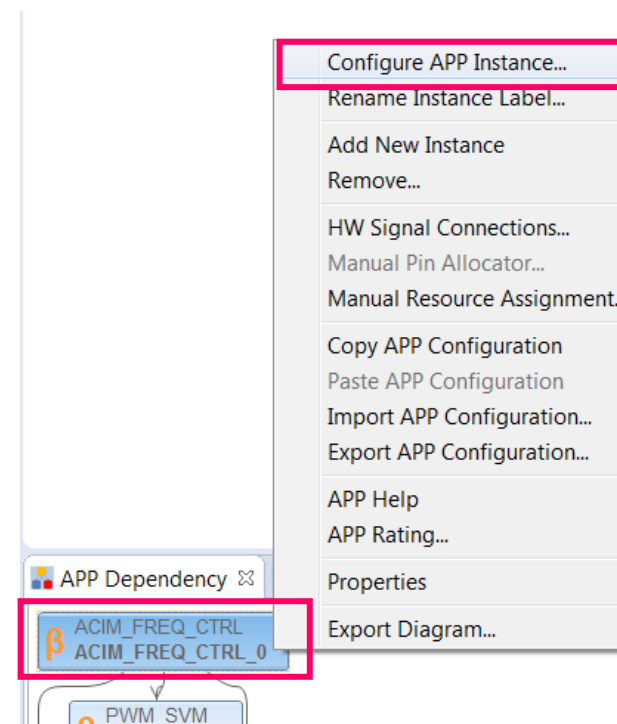
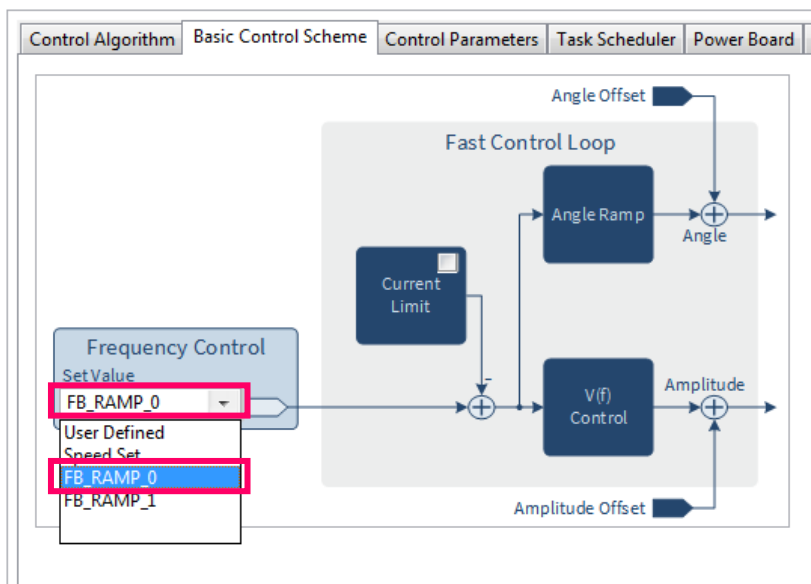

# Step 3: APP configuration

- › Open "Power Board" **tab**
- › Set "Dead time rising edge[ns]" to 1100
- › Set "Dead time falling edge[ns]" to 885

Control Algorithm Basic Control Scheme Control Parameters Task Scheduler **Power Board** Mea

Power Board Configuration

DC link voltage [V]: 24

Dead time rising edge [ns]: 1100

Dead time falling edge [ns]: 885

Switch delay [ns]: 500

Inverter enable pin: Active High

Bootstrap time [ms]: 0

Output polarity

High side switches: Active Low

Low side switches: Active Low

Current Amplifier Configuration

VADC reference [V]: 3.3

Rshunt [mOhms]: 10

Amplifier gain: 21

PWM Timer\*  
Compare value

High Side PWM

Low Side PWM

Phase Voltage

Amplifier Bias Voltage

$I_{bc}$

# Step 4: Pin assignment

> The pin allocation can be done in two ways:

- 1) table view

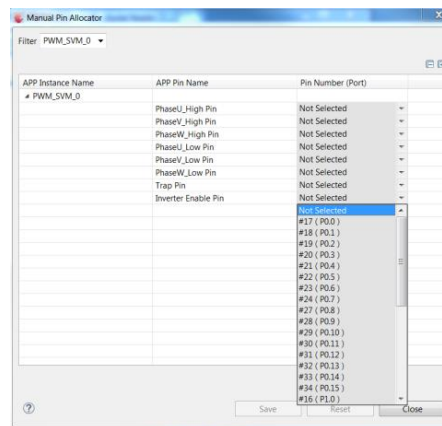

- 2) graphical view

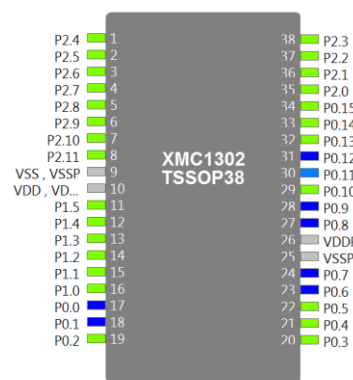
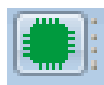

# Step 4: Pin assignment- table view

The Pin Allocation can be done in two ways:

> Table view:

- Click "Manual Pin Allocator" 
- Table: select the corresponding pin for each pin
- Click "Save"

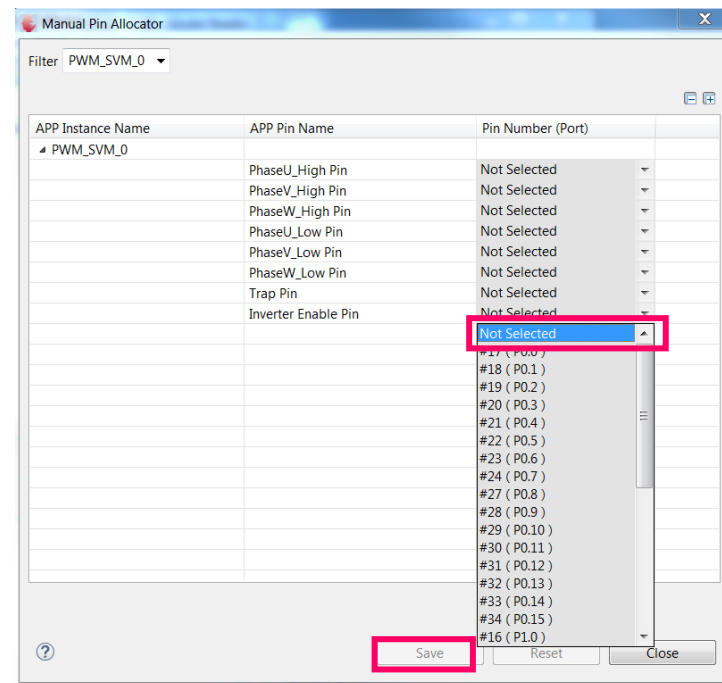
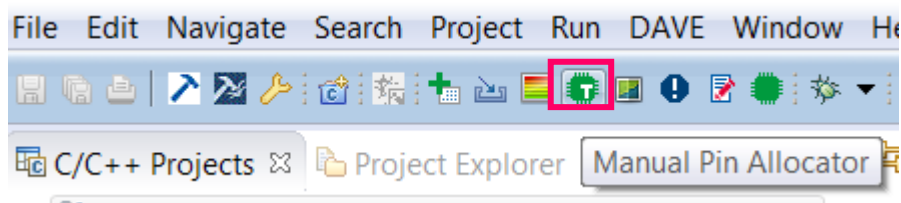

# Step 4: Pin assignment– graphical view

## > Graphical view:

- Click "Pin Mapping Perspective"
- Select pin in the left table
- Right click on a colored pin
- Click "Assign"

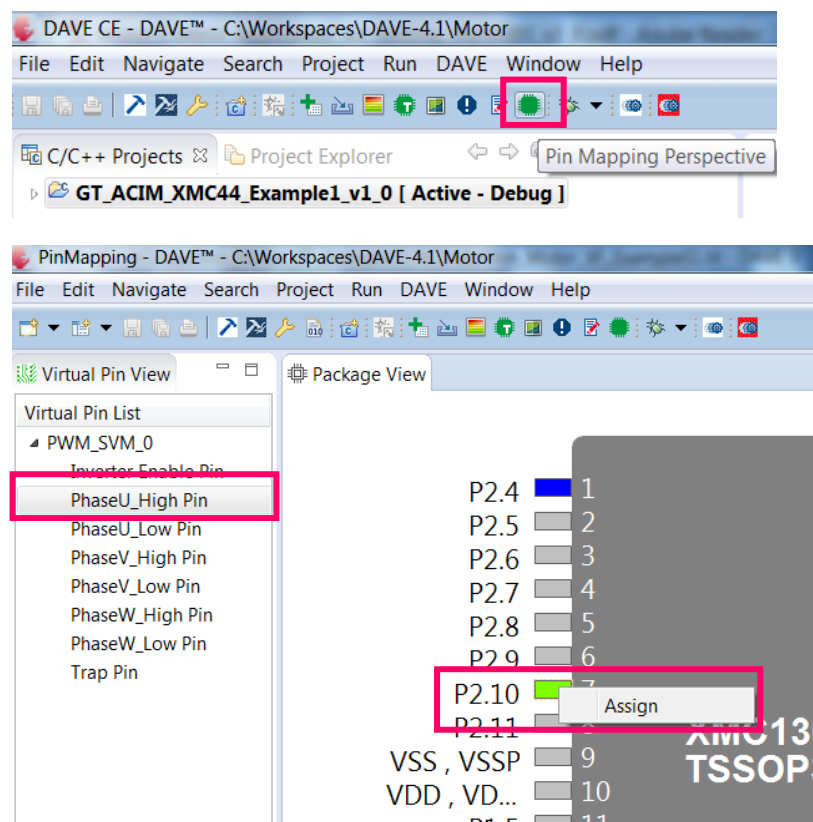
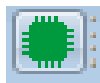

*Note: See legend color code for additional information*

# Step 4a: Pin assignment - XMC1300

Manual Pin Allocator

Filter: ALL

APP Instance Name	APP Pin Name	Pin Number (Port)
▲ PWM_SVM_0		
	PhaseU_High Pin	#17 ( P0.0 )
	PhaseV_High Pin	#24 ( P0.7 )
	PhaseW_High Pin	#27 ( P0.8 )
	PhaseU_Low Pin	#18 ( P0.1 )
	PhaseV_Low Pin	#23 ( P0.6 )
	PhaseW_Low Pin	#28 ( P0.9 )
	Trap Pin	#31 ( P0.12 )
	Inverter Enable Pin	#30 ( P0.11 )

Buttons: Save, Reset, Close

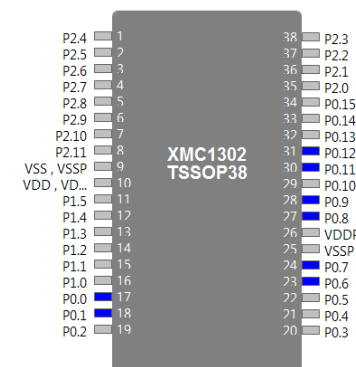

# Step 4b: Pin assignment- XMC4400

Manual Pin Allocator

Filter: ALL

APP Instance Name	APP Pin Name	Pin Number (Port)
▲ PWM_SVM_0		
	PhaseU_High Pin	#97 ( P0.5 )
	PhaseV_High Pin	#98 ( P0.4 )
	PhaseW_High Pin	#99 ( P0.3 )
	PhaseU_Low Pin	#100 ( P0.2 )
	PhaseV_Low Pin	#1 ( P0.1 )
	PhaseW_Low Pin	#2 ( P0.0 )
	Trap Pin	#89 ( P0.7 )
	Inverter Enable Pin	#68 ( P1.15 )

Save    Reset    Close

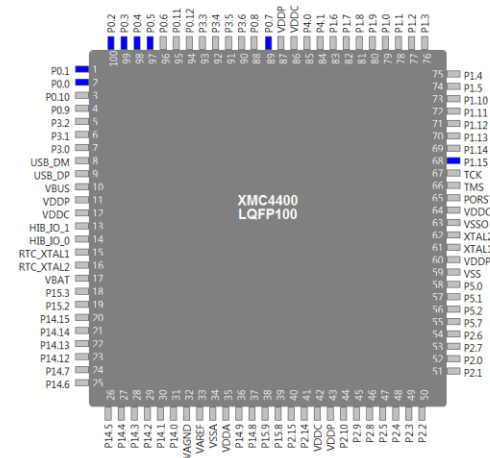

## Step 5: Generate code

- › Click "Generate Code" 
- Code Generation can take a few seconds.

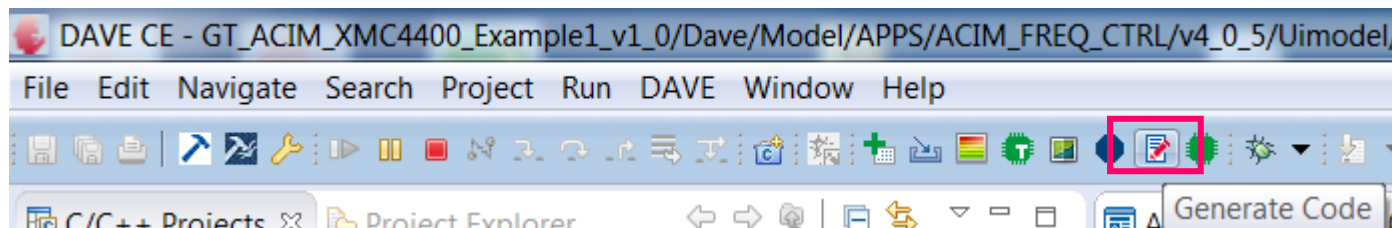



## Step 6: Add function

- › Edit main.c by adding the following function call:  
`ACIM_FREQ_CTRL_MotorStart(&ACIM_FREQ_CTRL_0);`

```

23 int main(void)
24 {
25     DAVE_STATUS_t status;
26
27     status = DAVE_Init();           /* Initialization of DAVE APPs */
28
29     if(status == DAVE_STATUS_FAILURE)
30     {
31         /* Placeholder for error handler code. The while loop below can be replaced with an user error handler. */
32         XMC_DEBUG("DAVE APPs initialization failed\n");
33
34         while(1U)
35         {
36
37         }
38     }
39
40     ACIM_FREQ_CTRL_MotorStart(&ACIM_FREQ_CTRL_0);
41     /* Placeholder for user application code. The while loop below can be replaced with user application code. */
42     while(1U)
43     {
44
45     }
46 }
47
  
```

# Step 7: Build project

> Build Project 

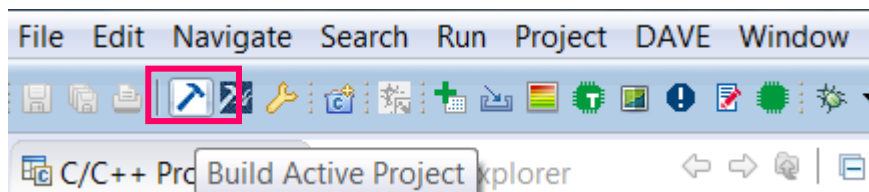

# Step 8: Debug – create debug session

- > Click “Debug”:
- > Double click “GDB SEGGER J-Link Debugging”
- > Click “Debug”
- > The debugger is downloading the program

(See next slide)

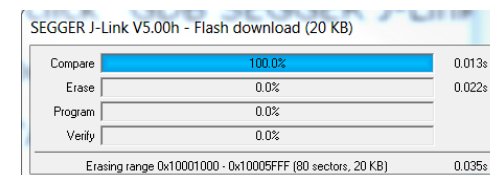
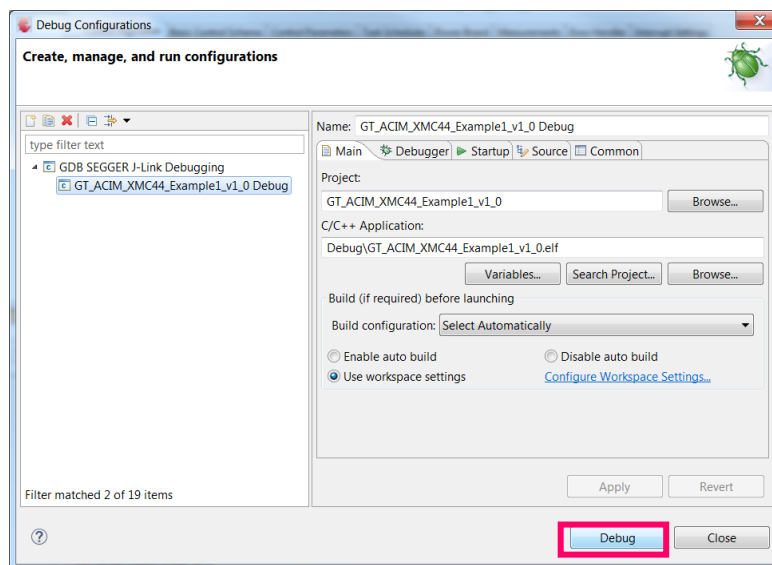
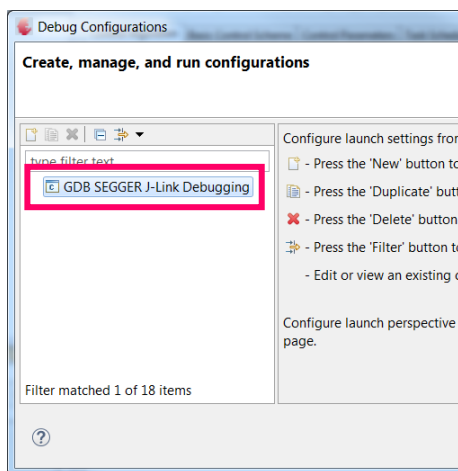
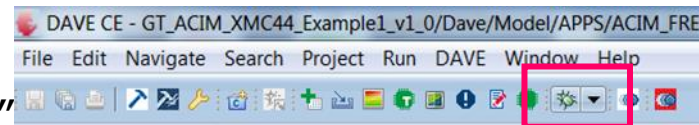

# Step 8: Debug – start program

- > Switch to debug perspective. Confirm with "YES"
- > To start the program click "Resume (F5)"

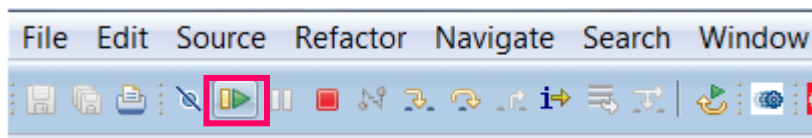
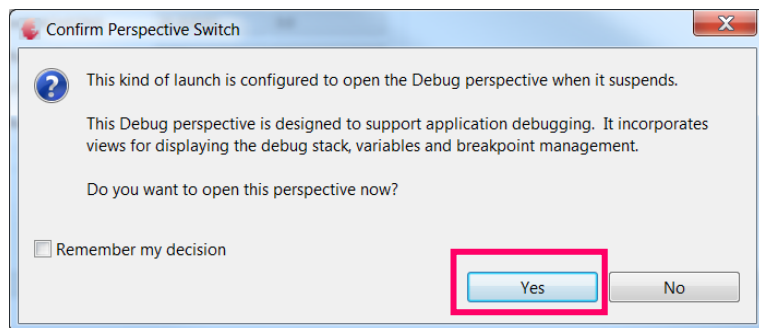

# Behavior

- > The Motor slowly ramps up to 1500rpm

$$N_s = \frac{60 \times f}{p}$$

$N_s$ =speed;  $f$ = frequency in Hz;  $p$ = No. of pole pair

$$N_s = \frac{60 \times 100}{4} = 1500\text{rpm}$$

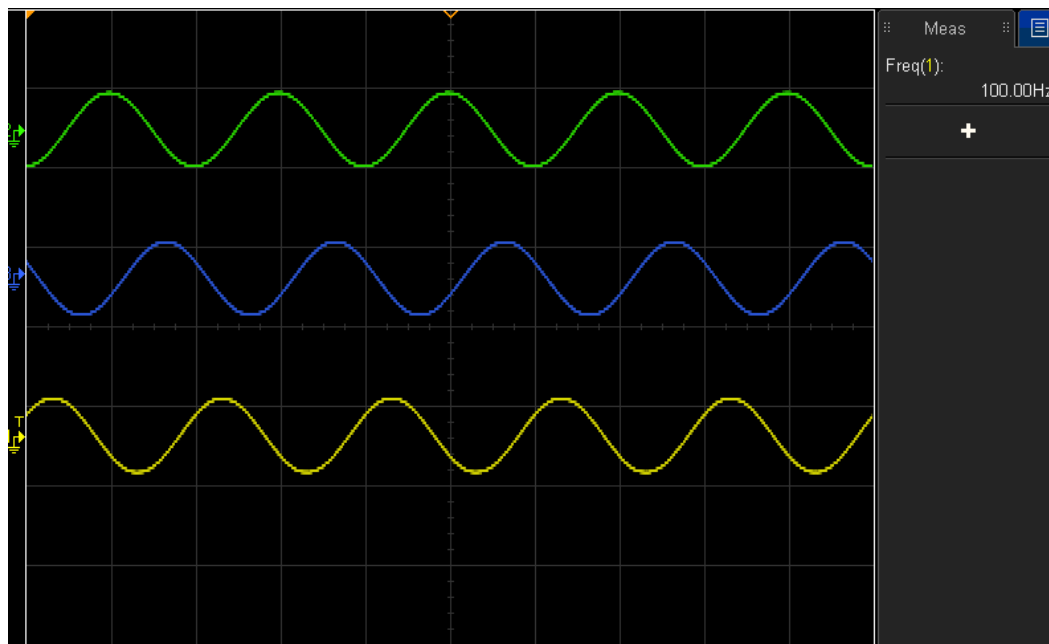

# Induction Motor V/F Control App

1 Motor Control Application Kit Composition

2 Development Tool: DAVE™ version 4

3 Example: PMSM Motor with fixed speed

4 Example: PMSM Motor with adjustable speed

5 Additional information

# Getting started limitations

- › The following example shows the default usage of the App.
- › This Getting Started shows how to create an example with the default settings. Only the used App configurations are described. More information about the spectrum of the App can be found in the Help or an Application Note.
- › The creation is described in steps. If a step is specific to XMC1300 or XMC4400 it is mentioned in the title and a sub-step e.g. 2.a, 2.b. Variation of the example (e.g. with adjustable speed) based on the main example.
- › The following examples based on ACIM\_FREQ\_CTRL/ACIM\_FREQ\_CTRL APP v. 4.0.5 **beta**
- › Example 2 with adjustable speed based on example 1. Only the delta is described in this chapter. The target speed is selected by adjusting the potentiometer.

# Step 1: APP configuration

- › open "ACIM\_FREQ\_CTRL" by double click or right click → "Configure App instance"
- › Open the "Measurements" **tab**
- › Click "Enable speed set via analog input"
- This will add the ADC APP. This can take a few seconds.

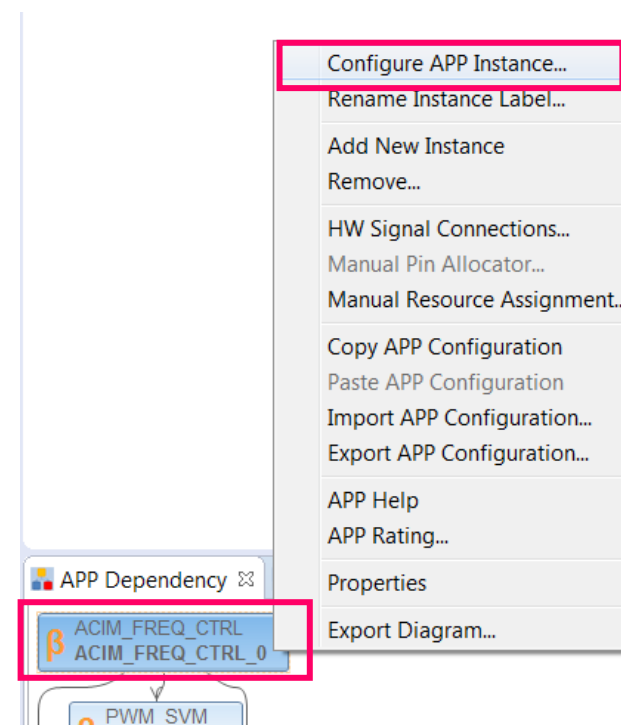
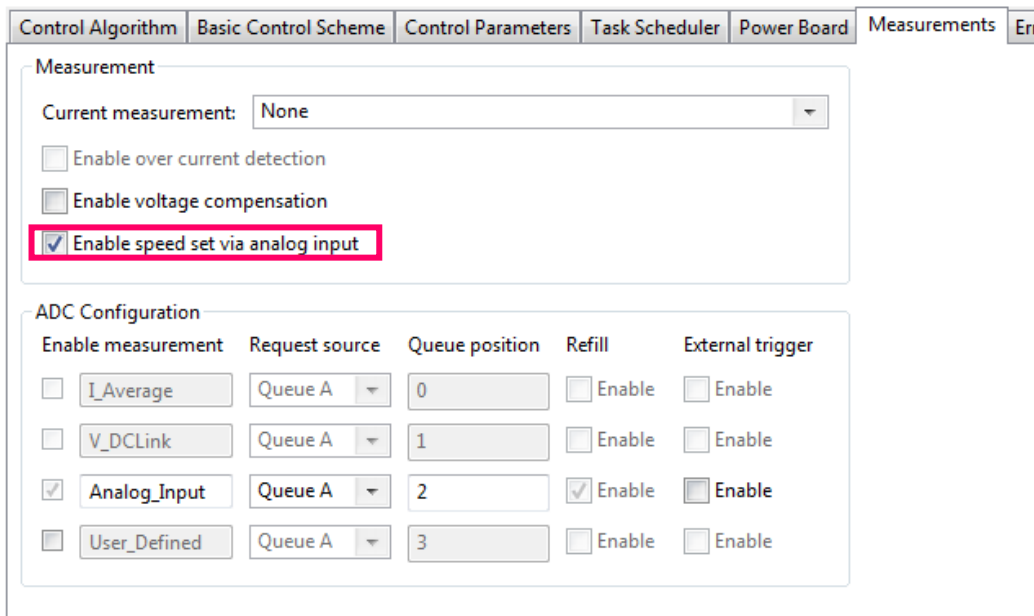



# Step 1: APP configuration – XMC4400

The V/f control is less efficient than FOC control. To reduce the maximum power consumption the default values is be changed. This only applies to XMC4400 kits.

- › Open the “Control Parameters” **tab**
- › Reduce “No load speed [rpm]” to 2000
- › Enable “User defined”
- › Set “V/f constant” to 70
- › Set “V/f offset” to 300

Control Algorithm	Basic Control Scheme	Control Parameters	Task Scheduler	Power Board	Measurements	Error Handler	Interrupt Settings
Control Panel Parameters		Motor Parameters					
Motor direction:	Clockwise		Nominal voltage [V]:	24			
User speed set [rpm]:	1500		No load speed [rpm]:	2000			
Over current limit [mA]:	500		Pole pair:	4			
Maximum voltage limit [%]:	100						
V/f Configuration							
	Default	<input checked="" type="checkbox"/> User defined					
V/f constant [mV/Hz]:	180	70					
V/f offset [mV]:	1200	300					

# Step 2: Pin assignment

› Assign the ADC pin in table or graphical view:

– 1) table view

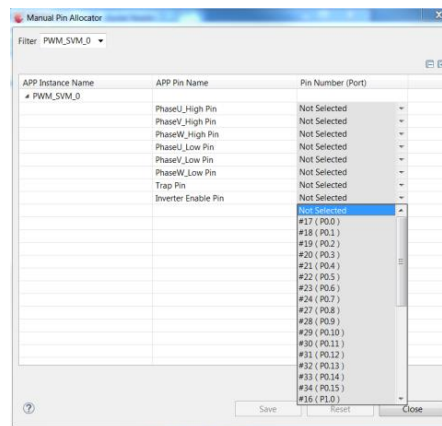

– 2) graphical view

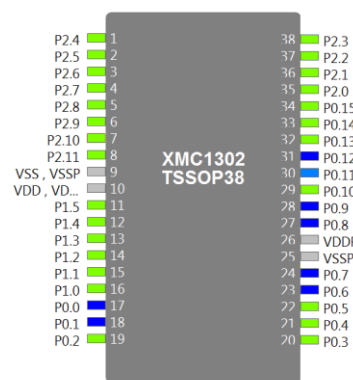
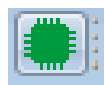

*Note: Pin assignment is explained in example 1 step 4*

# Step 2a: Pin assignment - XMC1300

- Allocate the "Analog\_Input pin" to the potentiometer input pin

Manual Pin Allocator

Filter: ALL

APP Instance Name	APP Pin Name	Pin Number (Port)
ACIM_FREQ_CTRL_0	Analog_Input pin	#2 ( P2.5 )
PWM_SVM_0	PhaseU_High Pin	#17 ( P0.0 )
	PhaseV_High Pin	#24 ( P0.7 )
	PhaseW_High Pin	#27 ( P0.8 )
	PhaseU_Low Pin	#18 ( P0.1 )
	PhaseV_Low Pin	#23 ( P0.6 )
	PhaseW_Low Pin	#28 ( P0.9 )
	Trap Pin	#31 ( P0.12 )
	Inverter Enable Pin	#30 ( P0.11 )

Buttons: Save, Reset, Close

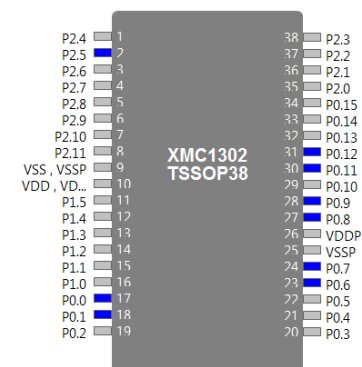



## Step 3: Generate, build, debug

› Repeat following steps from example 1:

- Step 5: Generate code



- Step 7: Build code



- Step 8: Debug



# Behavior

- › The target speed is selected by potentiometer
- › The target speed can vary from 0rpm to “No load speed”
- › Motor slowly ramps up or down to the target speed

$$N_s = \frac{60 \times f}{p}$$

$N_s$ =speed;  $f$ = frequency in Hz;  $p$ = No. of pole pair

$$N_s = \frac{60 \times 106}{4} = 1590\text{rpm}$$

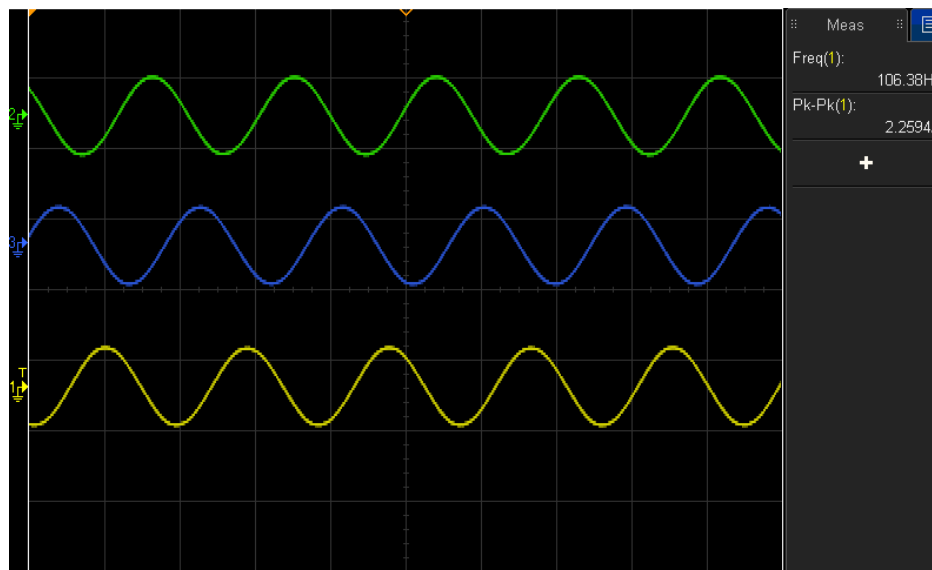

# Induction Motor V/F Control App

1 Motor Control Application Kit Composition

2 Development Tool: DAVE™ version 4

3 Example: PMSM Motor with fixed speed

4 Example: PMSM Motor with adjustable speed

5 Additional information

# App help

This will show helpful information regarding to the APP:

- > Right click on **ACIM\_FREQ\_CTRL\_0**
- > Select **"App Help"**
- > This will show the help contents this App

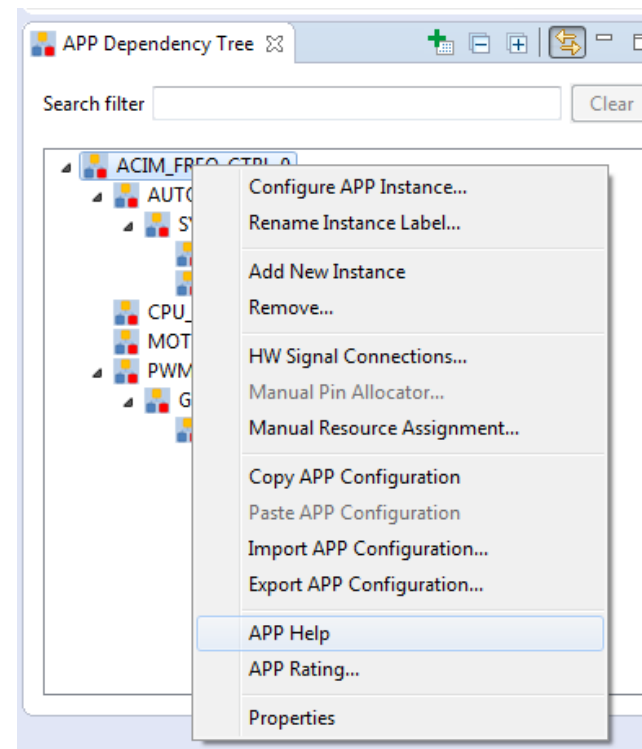
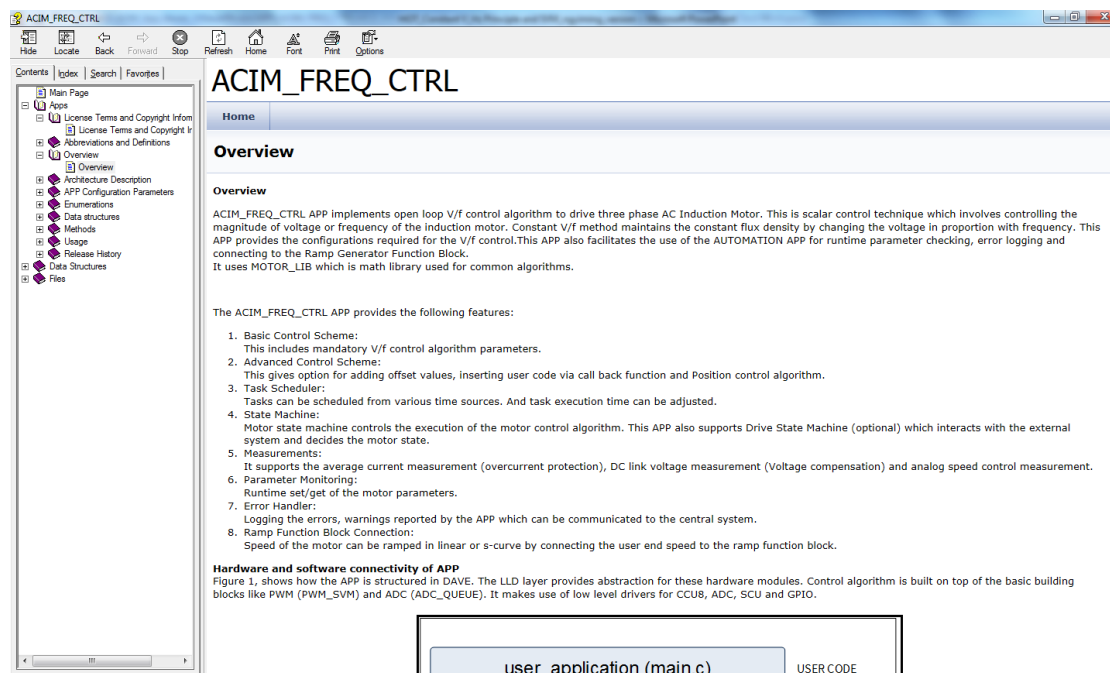



# Where to buy - XMC1300

Development Boards	Order Number
<p>XMC1300 Boot Kit</p>	 <p><a href="#"><u>KIT XMC13 BOOT 001</u></a></p>
<p>XMC1000 Motor Control Application Kit</p>	 <p><a href="#"><u>KIT XMC1x AK Motor 001</u></a></p>

# Where to buy – XMC4400

Development Boards		Order Number
XMC4400 Enterprise Kit		<a href="#"><u>KIT_XMC44_EE1_001</u></a>
General Purpose Motor Drive Kit		<a href="#"><u>KIT_XMC4x_MOT_GPDLV_001</u></a>
XMC4400 Motor Control Application Kit		<a href="#"><u>KIT_XMC44_AE3_001</u></a>

# General information

- › Information about all available XMC Motor Control Application Kits:

[LINK](#)

- › For latest updates, please refer to:

<http://www.infineon.com/xmc1000>

<http://www.infineon.com/xmc4000>

- › DAVE™ development platform:

<http://www.infineon.com/DAVE>

- › For support:

<http://www.infineonforums.com/forums/8-XMC-Forum>



Part of your life. Part of tomorrow.

