

IRHYB9A97034CM (JANSR2N7659D5)

PD-97993

Radiation Hardened Power MOSFET Thru-Hole (Low-Ohmic Tabless TO-257AA) 60V, 30A, P-channel, R9 Superjunction Technology

Features

- Single event effect (SEE) hardened (up to LET of 91.3 MeV·cm²/mg)
- Low R_{DS(on)}
- Improved SOA for linear mode operation
- Improved avalanche energy
- Simple drive requirements
- Hermetically sealed
- Electrically isolated
- ESD rating: Class 2 per MIL-STD-750, Method 1020

Potential Applications

- Power distribution
- Linear regulator
- Latching current limiter
- Load and protection switch

Product Validation

Qualified according to MIL-PRF-19500 for space applications

Description

IR HiRel R9 technology provides superior power MOSFETs for space applications. This family of p-channel MOSFETs are the first radiation hardened devices that are based on a superjunction technology. These devices have improved immunity to Single Event Effect (SEE) and have been characterized for useful performance with Linear Energy Transfer (LET) up to 91.3 MeV·cm²/mg. Their combination of low R_{DS(on)} and improved SOA allows for better performance in applications such as Latching Current Limiters (LCL) or Solid-State Power Controllers (SSPC). These devices retain all of the well established advantages of MOSFETs such as voltage control, fast switching and temperature stability of electrical parameters.

Ordering Information

Table 1 Ordering options

Part number	Package	Screening Level	TID Level
IRHYS9A97034CM	Low Ohmic Tabless TO-257AA	COTS	100krad(Si)
JANSR2N7659D5	Low Ohmic Tabless TO-257AA	JANS	100krad(Si)
IRHYS9A93034CM	Low Ohmic Tabless TO-257AA	COTS	300krad(Si)
JANSF2N7659D5	Low Ohmic Tabless TO-257AA	JANS	300krad(Si)

Product Summary

- **Part number:** IRHYB9A97034CM (JANSR2N7659D5), IRHYB9A93034CM (JANSF2N7659D5)
- **REF:** MIL-PRF-19500/780
- **Radiation level:** 100 krad (Si), 300 krad (Si)
- **R_{DS(on), max}:** 46mΩ
- **I_D:** -30A*



Table of contents

Table of contents

Features	1
Potential Applications.....	1
Product Validation.....	1
Description	1
Ordering Information.....	1
Table of contents.....	2
1 Absolute Maximum Ratings	3
2 Device Characteristics	4
2.1 Electrical Characteristics (Pre-Irradiation).....	4
2.2 Source-Drain Diode Ratings and Characteristics (Pre-Irradiation)	5
2.3 Thermal Characteristics	5
2.4 Radiation Characteristics.....	5
2.4.1 Electrical Characteristics – Post Total Dose Irradiation	5
2.4.2 Single Event Effects – Safe Operating Area.....	6
3 Electrical Characteristics Curves (Pre-irradiation)	7
4 Test Circuits (Pre-irradiation)	11
5 Package Outline.....	12
Revision history.....	13

Absolute Maximum Ratings

1 Absolute Maximum Ratings

Table 2 Absolute Maximum Ratings (Pre-Irradiation)

Symbol	Parameter	Value	Unit
$I_{D1} @ V_{GS} = -12V, T_C = 25^\circ C$	Continuous Drain Current	-30*	A
$I_{D2} @ V_{GS} = -12V, T_C = 100^\circ C$	Continuous Drain Current	-20	A
$I_{DM} @ T_C = 25^\circ C$	Pulsed Drain Current ¹	-120	A
$P_D @ T_C = 25^\circ C$	Maximum Power Dissipation	75	W
	Linear Derating Factor	0.6	W/°C
V_{GS}	Gate-to-Source Voltage	± 20	V
E_{AS}	Single Pulse Avalanche Energy ²	1520	mJ
I_{AR}	Avalanche Current ¹	-20	A
E_{AR}	Repetitive Avalanche Energy ¹	7.5	mJ
dv/dt	Peak Diode Reverse Recovery ³	-5.8	V/ns
T_J T_{STG}	Operating Junction and Storage Temperature Range	-55 to +150	°C
	Lead Temperature	300 (0.063in./1.6mm from case for 10s)	
	Weight	4.3 (Typical)	g

*Current is limited by package

¹ Repetitive Rating; Pulse width limited by maximum junction temperature.² $V_{DD} = -60V$, starting $T_J = 25^\circ C$, $L = 7.6mH$, Peak $I_L = -20A$, $V_{GS} = -20V$ ³ $I_{SD} \leq -30A$, $di/dt \leq -905A/\mu s$, $V_{DD} \leq -60V$, $T_J \leq 150^\circ C$

Device Characteristics

2 Device Characteristics

2.1 Electrical Characteristics (Pre-Irradiation)

Table 3 Static and Dynamic Electrical Characteristics @ $T_j = 25^\circ\text{C}$ (Unless Otherwise Specified)

Symbol	Parameter	Min.	Typ.	Max.	Unit	Test Conditions
BV_{DSS}	Drain-to-Source Breakdown Voltage	-60	—	—	V	$V_{GS} = 0V, I_D = -1.0mA$
$\Delta BV_{DSS}/\Delta T_J$	Breakdown Voltage Temp. Coefficient	—	-0.07	—	V/ $^\circ\text{C}$	Reference to 25°C , $I_D = -1.0mA$
$R_{DS(on)}$	Static Drain-to-Source On-State Resistance	—	—	46	m Ω	$V_{GS} = -12V, I_{D2} = -20A^1$
$V_{GS(th)}$	Gate Threshold Voltage	-2.0	—	-4.0	V	$V_{DS} \geq V_{GS}, I_D = -1mA$
$\Delta V_{GS(th)}/\Delta T_J$	Gate Threshold Voltage Coefficient	—	5.6	—	mV/ $^\circ\text{C}$	
Gfs	Forward Transconductance	15	—	—	S	$V_{DS} = -15V, I_{D2} = -20A^1$
I_{DSS}	Zero Gate Voltage Drain Current	—	—	-10	μA	$V_{DS} = -48V, V_{GS} = 0V$
		—	—	-25		$V_{DS} = -48V, V_{GS} = 0V, T_J = 125^\circ\text{C}$
I_{GSS}	Gate-to-Source Leakage Forward	—	—	-100	nA	$V_{GS} = -20V$
	Gate-to-Source Leakage Reverse	—	—	100		$V_{GS} = 20V$
Q_G	Total Gate Charge	—	—	48	nC	$I_{D1} = -30A$
Q_{GS}	Gate-to-Source Charge	—	—	17		$V_{DS} = -30V$
Q_{GD}	Gate-to-Drain ('Miller') Charge	—	—	14		$V_{GS} = -12V$
$t_{d(on)}$	Turn-On Delay Time	—	—	18	ns	$I_{D1} = -30A^{**}$
t_r	Rise Time	—	—	66		$V_{DD} = -30V$
$t_{d(off)}$	Turn-Off Delay Time	—	—	77		$R_G = 7.5\Omega$
t_f	Fall Time	—	—	48		$V_{GS} = -12V$
$L_s + L_D$	Total Inductance	—	6.8	—	nH	Measured from Drain lead (6mm / 0.25in. from package) to Source lead (6mm / 0.25in. from package) with Source wires internally bonded from Source Pin to Drain Pad
C_{iss}	Input Capacitance	—	2490	—	pF	$V_{GS} = 0V$
C_{oss}	Output Capacitance	—	735	—		$V_{DS} = -25V$
C_{rss}	Reverse Transfer Capacitance	—	30	—		$f = 1.0MHz$
R_G	Gate Resistance	—	5.0	—	Ω	$f = 1.0MHz$, open drain

** Switching speed maximum limits are based on manufacturing test equipment and capability.

¹ Pulse width $\leq 300 \mu\text{s}$; Duty Cycle $\leq 2\%$

Device Characteristics

2.2 Source-Drain Diode Ratings and Characteristics (Pre-Irradiation)

Table 4 Source-Drain Diode Characteristics

Symbol	Parameter	Min.	Typ.	Max.	Unit	Test Conditions
I_S	Continuous Source Current (Body Diode)	—	—	-30	A	
I_{SM}	Pulsed Source Current (Body Diode) ¹	—	—	-120	A	
V_{SD}	Diode Forward Voltage	—	—	-1.3	V	$T_J = 25^\circ\text{C}$, $I_S = -30\text{A}$, $V_{GS} = 0\text{V}$ ²
t_{rr}	Reverse Recovery Time	—	53	80	ns	$T_J = 25^\circ\text{C}$, $I_F = -30\text{A}$, $V_{DD} \leq -25\text{V}$
Q_{rr}	Reverse Recovery Charge	—	107	—	nC	$di/dt = -100\text{A}/\mu\text{s}$ ²
t_{on}	Forward Turn-On Time	Intrinsic turn-on time is negligible (turn-on is dominated by $L_S + L_D$)				

2.3 Thermal Characteristics

Table 5 Thermal Resistance

Symbol	Parameter	Min.	Typ.	Max.	Unit
$R_{\theta JC}$	Junction-to-Case	—	—	1.67	$^\circ\text{C}/\text{W}$
$R_{\theta JA}$	Junction-to-Ambient	—	—	80	

2.4 Radiation Characteristics

IR HiRel radiation hardened MOSFETs are tested to verify their radiation hardness capability. The hardness assurance program at IR HiRel is comprised of two radiation environments. Every manufacturing lot is tested for total ionizing dose (per notes 3 and 4) using the TO-3 package. Both pre- and post-irradiation performance are tested and specified using the same drive circuitry and test conditions in order to provide a direct comparison.

2.4.1 Electrical Characteristics — Post Total Dose Irradiation

Table 6 Electrical Characteristics @ $T_J = 25^\circ\text{C}$, Post Total Dose Irradiation^{3, 4}

Symbol	Parameter	Up to 300krad (Si) ⁵		Unit	Test Conditions
		Min.	Max.		
BV_{DSS}	Drain-to-Source Breakdown Voltage	-60	—	V	$V_{GS} = 0\text{V}$, $I_D = -1\text{mA}$
$V_{GS(th)}$	Gate Threshold Voltage	-2.0	-4.0	V	$V_{DS} \geq V_{GS}$, $I_D = -1\text{mA}$
I_{GSS}	Gate-to-Source Leakage Forward	—	-100	nA	$V_{GS} = -20\text{V}$
	Gate-to-Source Leakage Reverse	—	100		$V_{GS} = 20\text{V}$
I_{DSS}	Zero Gate Voltage Drain Current	—	-10	μA	$V_{DS} = -48\text{V}$, $V_{GS} = 0\text{V}$
$R_{DS(on)}$	Static Drain-to-Source On-State Resistance (TO-3) ²	—	46	$\text{m}\Omega$	$V_{GS} = -12\text{V}$, $I_{D2} = -20\text{A}$
$R_{DS(on)}$	Static Drain-to-Source On-State Resistance (Low-Ohmic –Tabless TO-257AA) ²	—	46	$\text{m}\Omega$	$V_{GS} = -12\text{V}$, $I_{D2} = -20\text{A}$
V_{SD}	Diode Forward Voltage	—	-1.3	V	$V_{GS} = 0\text{V}$, $I_F = -30\text{A}$

¹ Repetitive Rating; Pulse width limited by maximum junction temperature.² Pulse width $\leq 300 \mu\text{s}$; Duty Cycle $\leq 2\%$ ³ Total Dose Irradiation with V_{GS} Bias. $V_{GS} = -12\text{V}$ applied and $V_{DS} = 0$ during irradiation per MIL-STD-750, Method 1019, condition A.⁴ Total Dose Irradiation with V_{DS} Bias. $V_{DS} = -48\text{V}$ applied and $V_{GS} = 0$ during irradiation per MIL-STD-750, Method 1019, condition A.⁵ Part numbers IRHYB9A97034CM (JANSR2N7659D5) and IRHYS9A93034CM (JANSF2N7659D5)

Device Characteristics

2.4.2 Single Event Effects — Safe Operating Area

IR HiRel radiation hardened MOSFETs have been characterized in heavy ion environment for Single Event Effects (SEE). Single Event Effects characterization is illustrated in Fig. 1 and Table 7.

Table 7 Typical Single Event Effects Safe Operating Area

Ion	LET (MeV·cm ² /mg)	Energy (MeV)	Range (μm)	V _{DS} (V)			
				V _{GS} = 0V	V _{GS} = 1V	V _{GS} = 5V	V _{GS} = 10V
Kr	38.7	325	40.1	-60	-60	-60	-60
Xe	61.5	605	50.2	-60	-60	-60	—
Au	91.3	1295	71.6	-60	-60	—	—

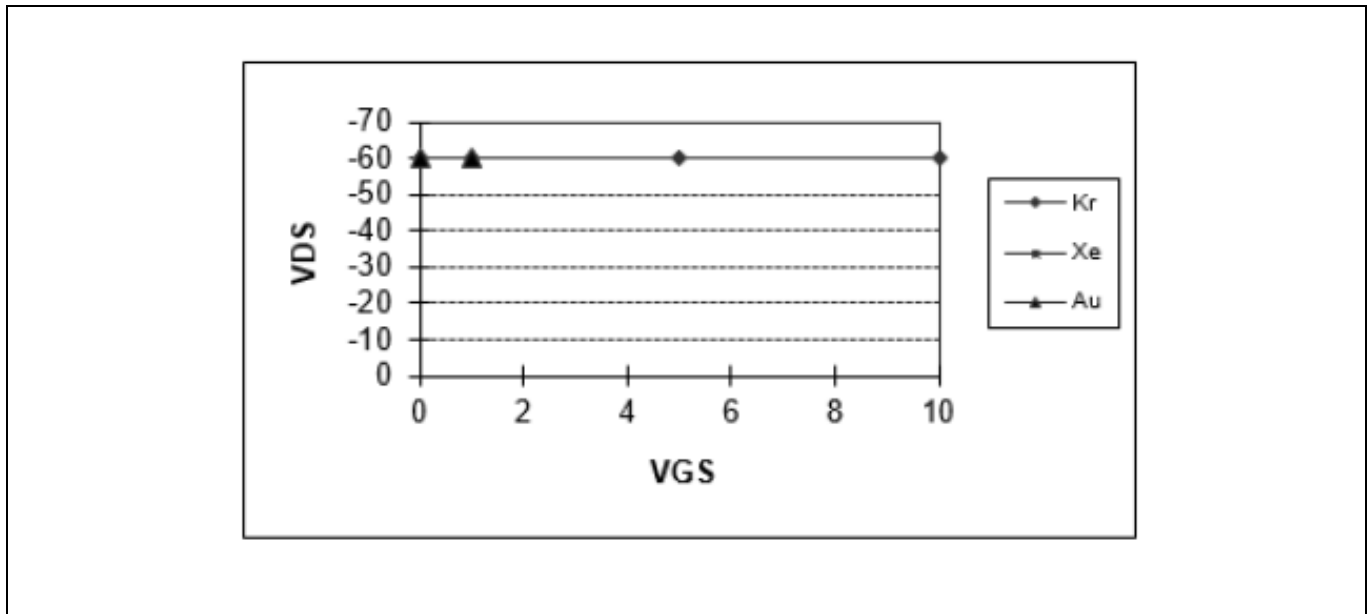

Figure 1 Typical Single Event Effect, Safe Operating Area

3 Electrical Characteristics Curves (Pre-irradiation)

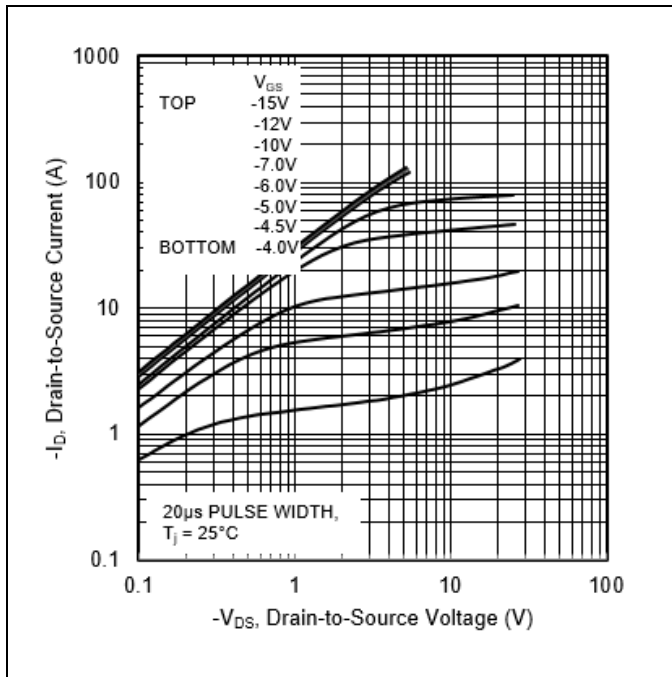

Figure 2 Typical Output Characteristics

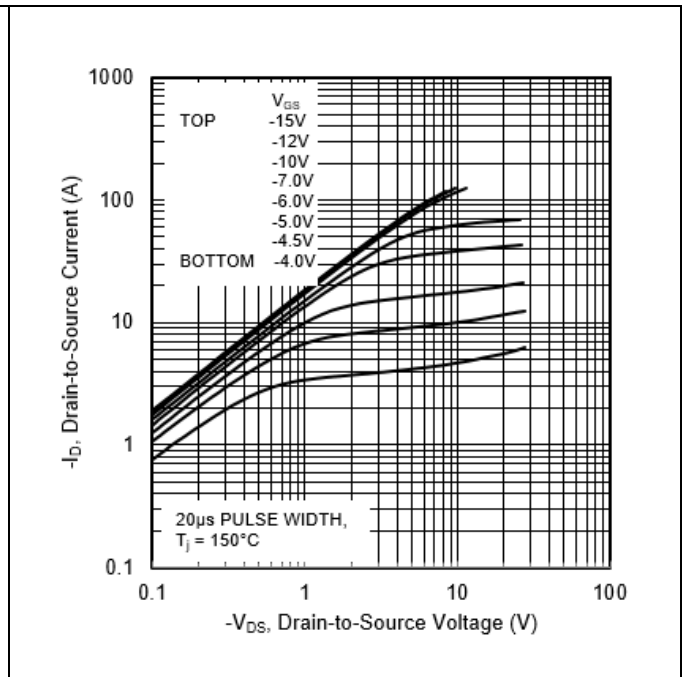

Figure 3 Typical Output Characteristics

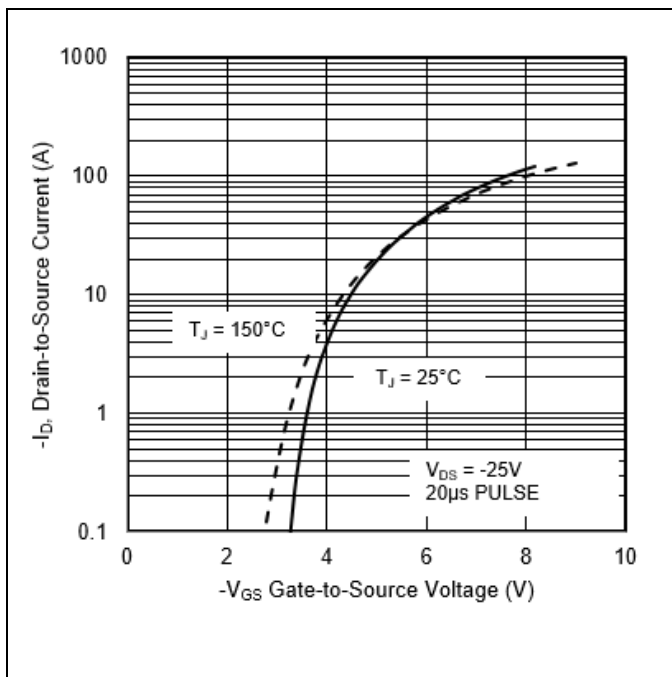

Figure 4 Typical Transfer Characteristics

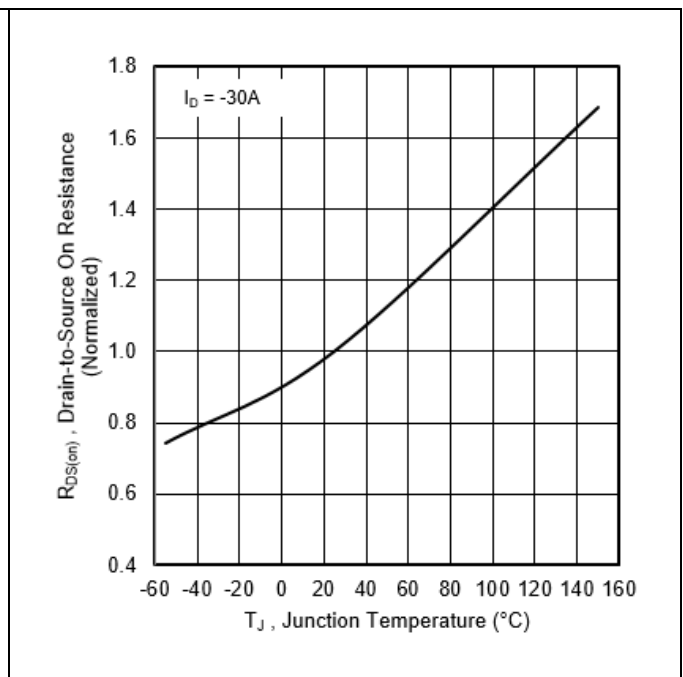

Figure 5 Normalized On-Resistance Vs. Temperature

IRHYB9A97034CM (JANSR2N7659D5)

Radiation Hardened Power MOSFET Thru-Hole (Low- Ohmic Tabless - TO-257AA)

Electrical Characteristics Curves (Pre-irradiation)

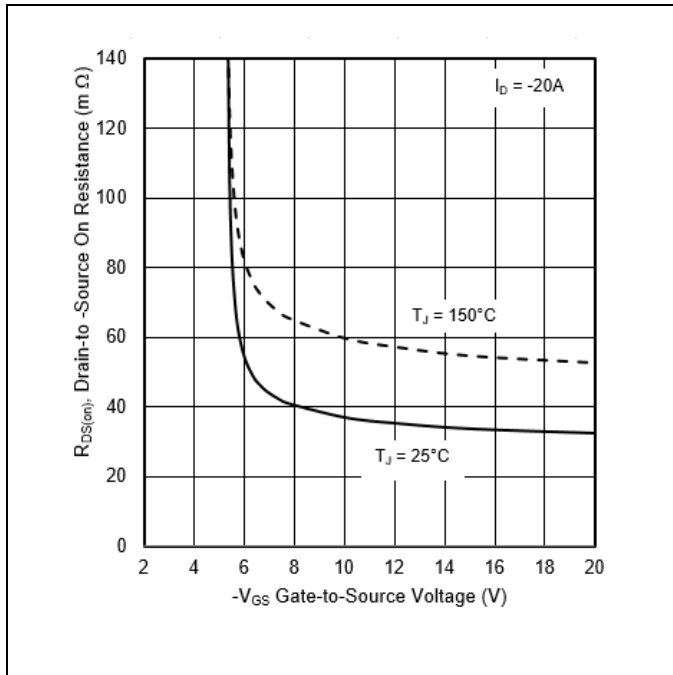

Figure 6 Typical On-Resistance Vs. Gate Voltage

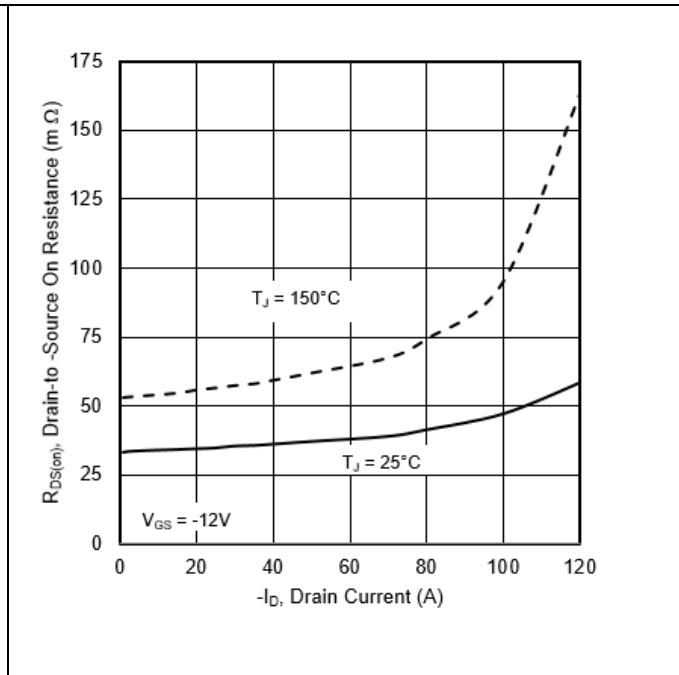

Figure 7 Typical On-Resistance Vs. Drain Current

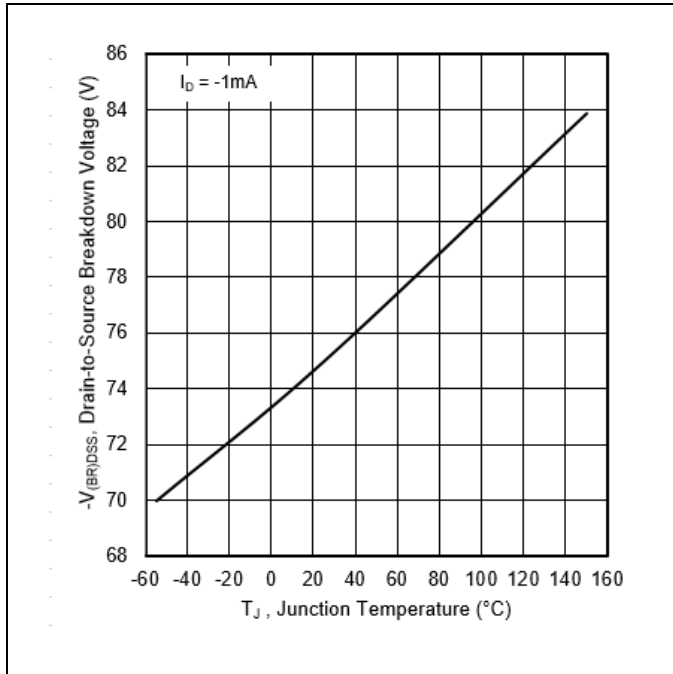

Figure 8 Typical Drain-to-Source Breakdown Voltage Vs. Temperature

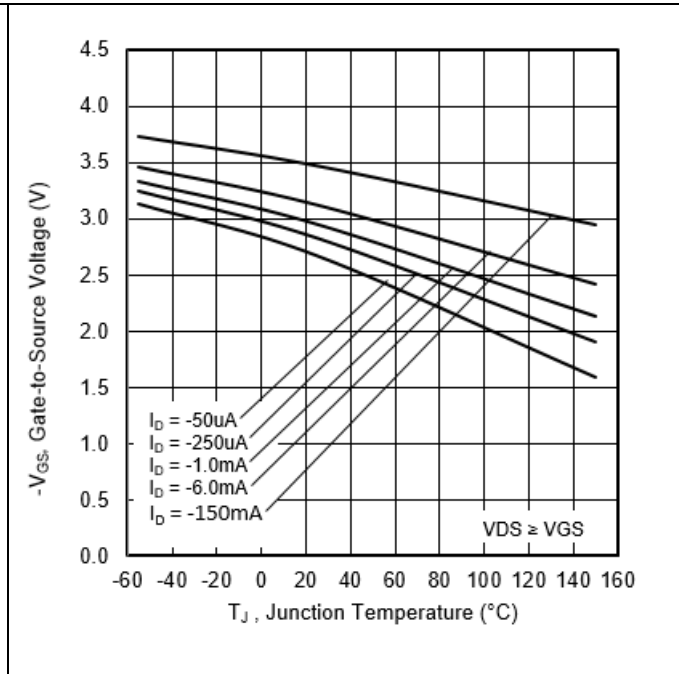

Figure 9 Typical Threshold Voltage Vs. Temperature

IRHYB9A97034CM (JANSR2N7659D5)

Radiation Hardened Power MOSFET Thru-Hole (Low- Ohmic Tabless - TO-257AA)

Electrical Characteristics Curves (Pre-irradiation)

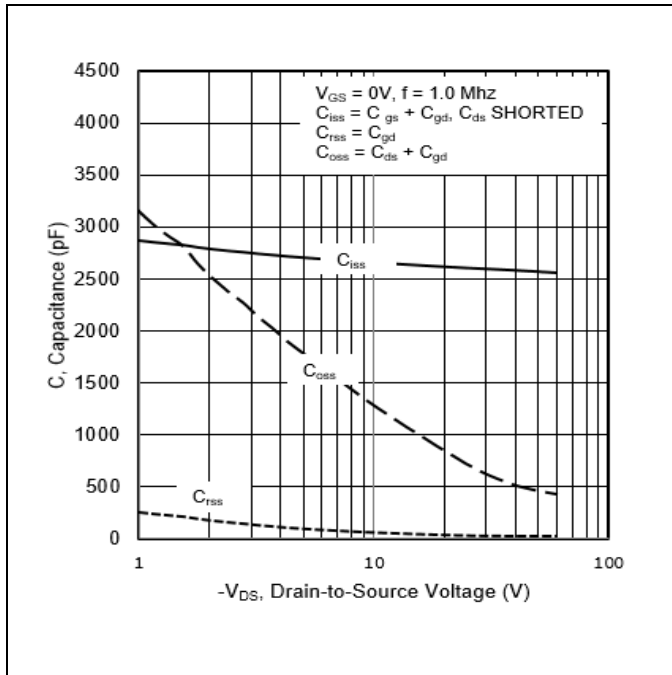

Figure 10 Typical Capacitance Vs. Drain-to-Source Voltage

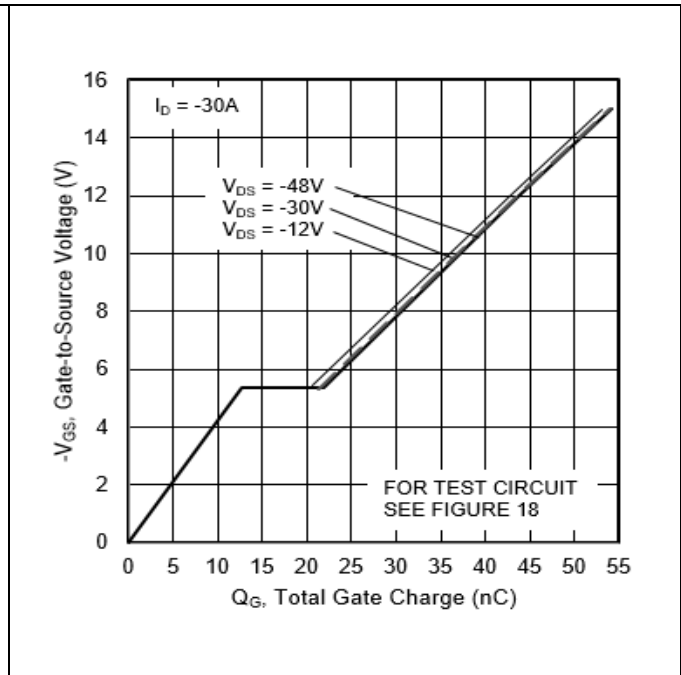

Figure 11 Gate-to-Source Voltage Vs. Typical Gate Charge

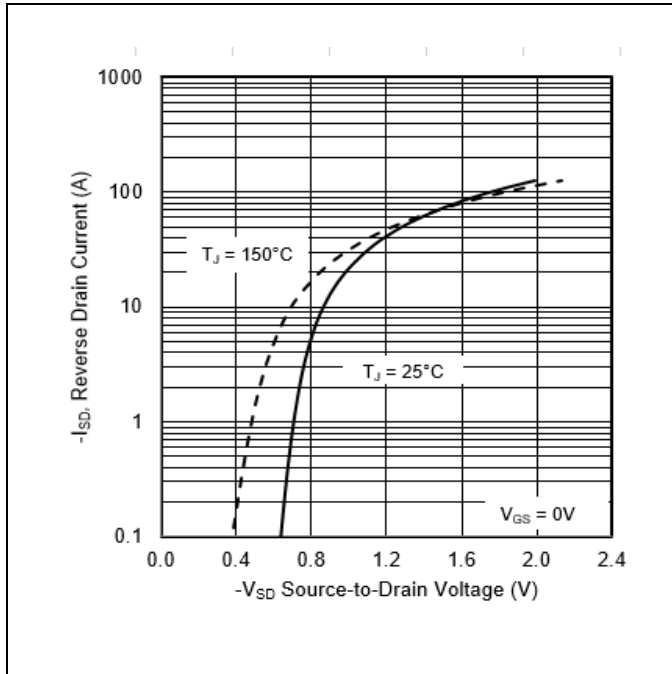

Figure 12 Typical Source-Drain Current Vs. Diode Forward Voltage

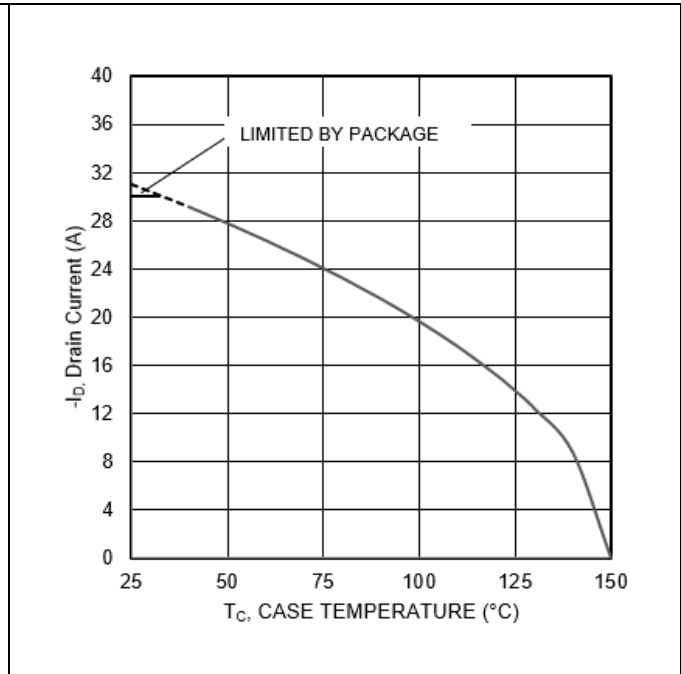

Figure 13 Maximum Drain Current Vs. Case Temperature

IRHYB9A97034CM (JANSR2N7659D5)

Radiation Hardened Power MOSFET Thru-Hole (Low- Ohmic Tabless - TO-257AA)

Electrical Characteristics Curves (Pre-irradiation)

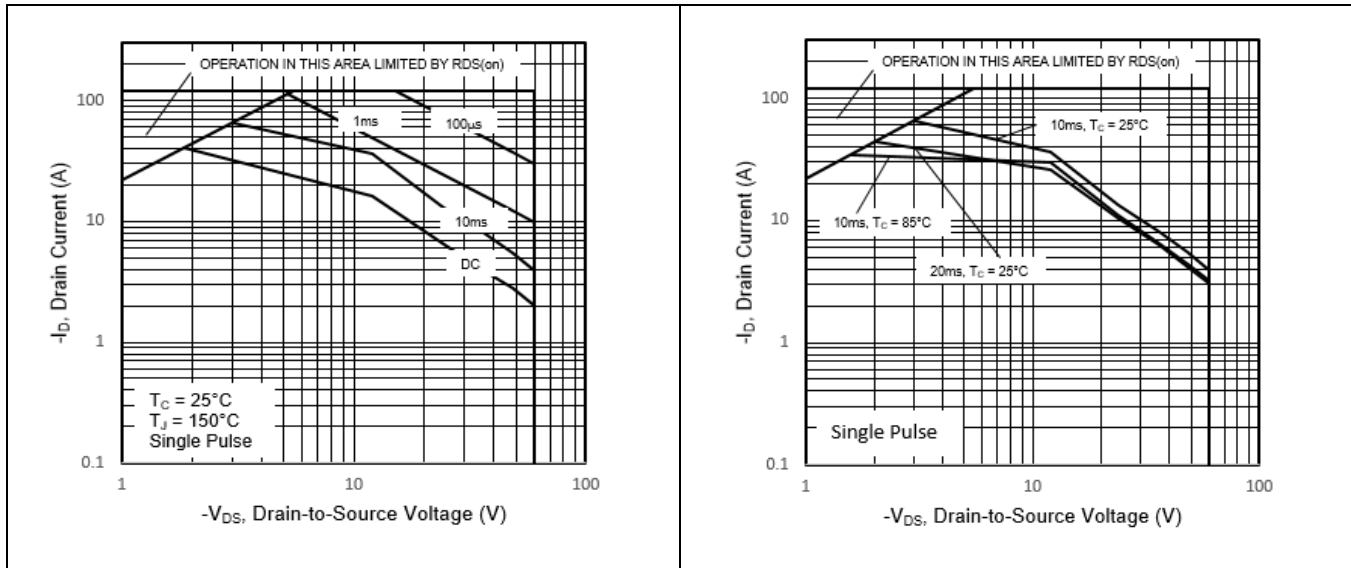

Figure 14 Maximum Safe Operating Area

Figure 15 Maximum Safe Operating Area

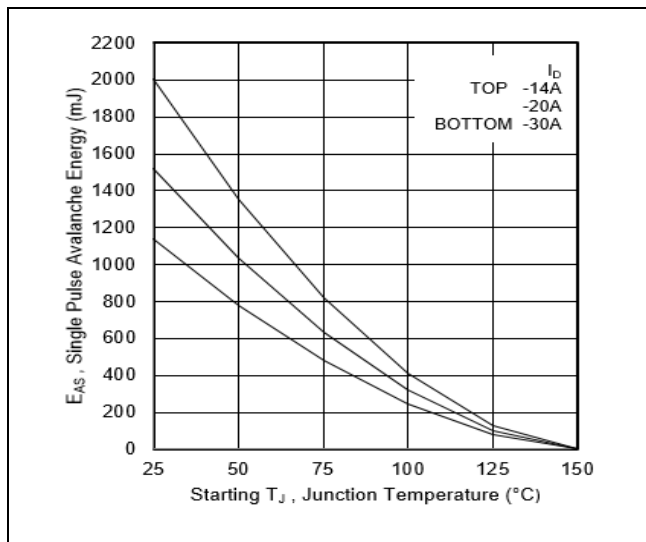

Figure 16 Maximum Avalanche Energy Vs. Junction Temperature

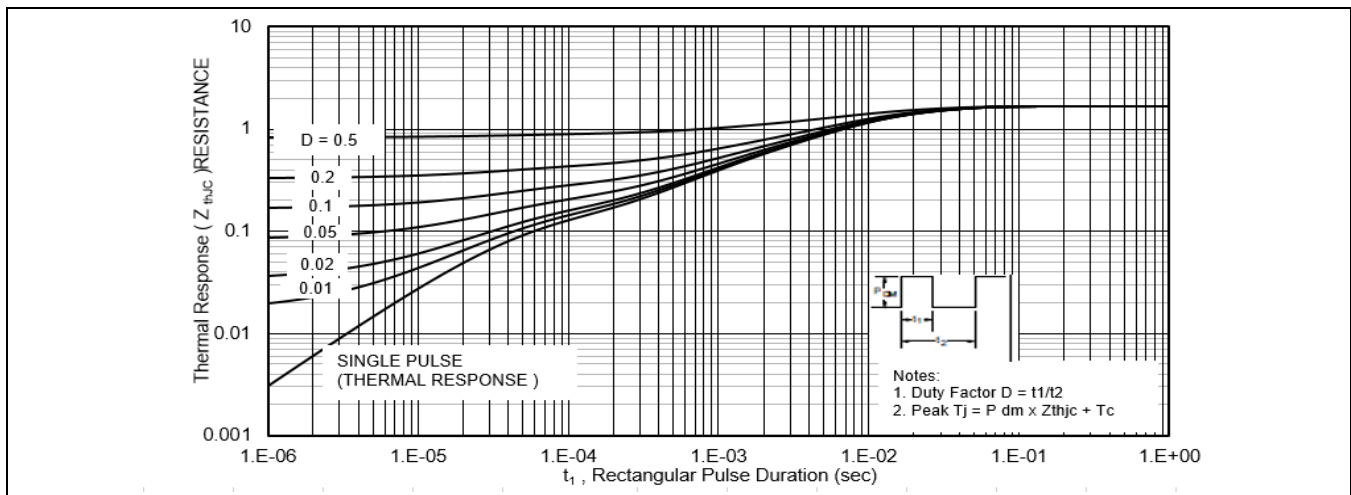

Figure 17 Maximum Effective Transient Thermal Impedance, Junction-to-Case

IRHYB9A97034CM (JANSR2N7659D5)

Radiation Hardened Power MOSFET Thru-Hole (Low- Ohmic Tabless - TO-257AA)

Test Circuits (Pre-irradiation)

4 Test Circuits (Pre-irradiation)

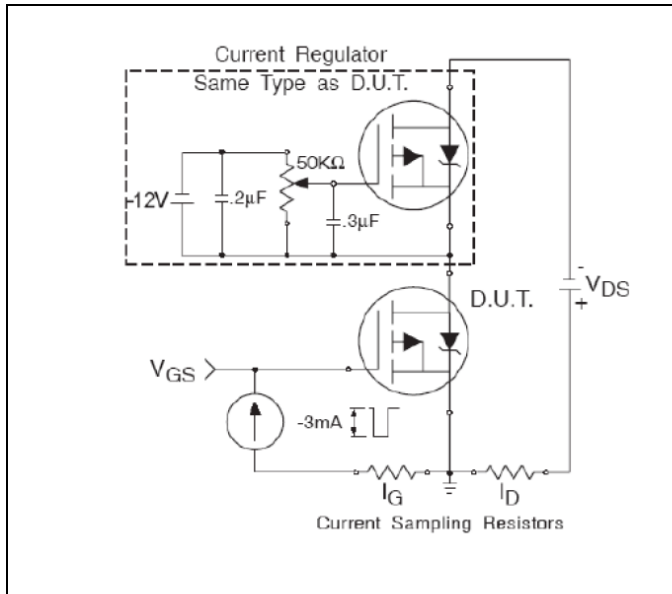

Figure 18 Gate Charge Test Circuit

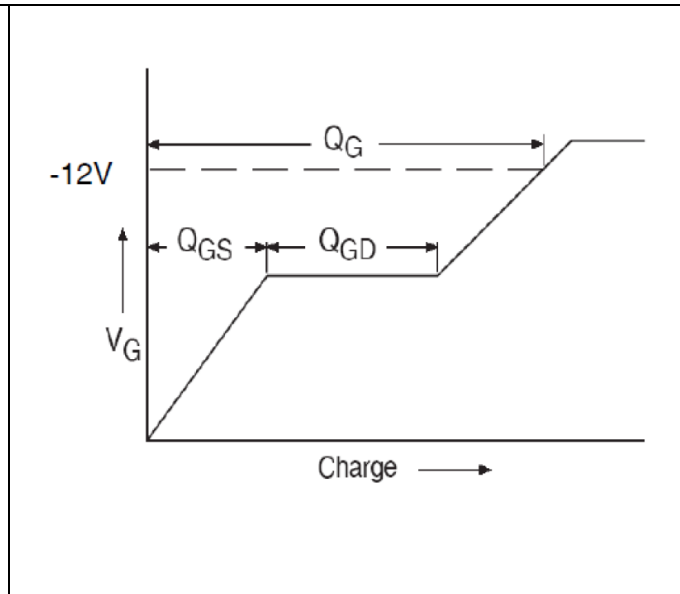

Figure 19 Gate Charge Waveform

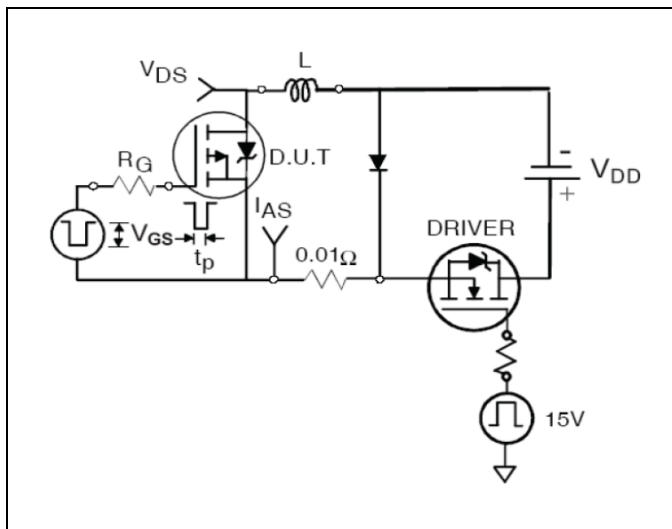

Figure 20 Unclamped Inductive Test Circuit

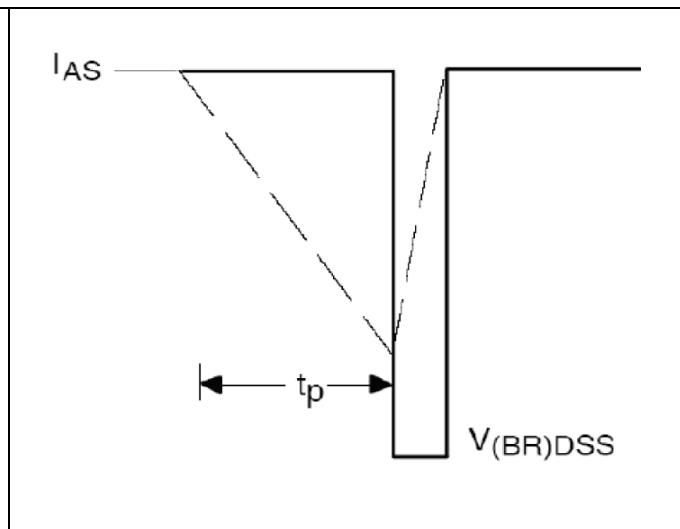

Figure 21 Unclamped Inductive Waveform

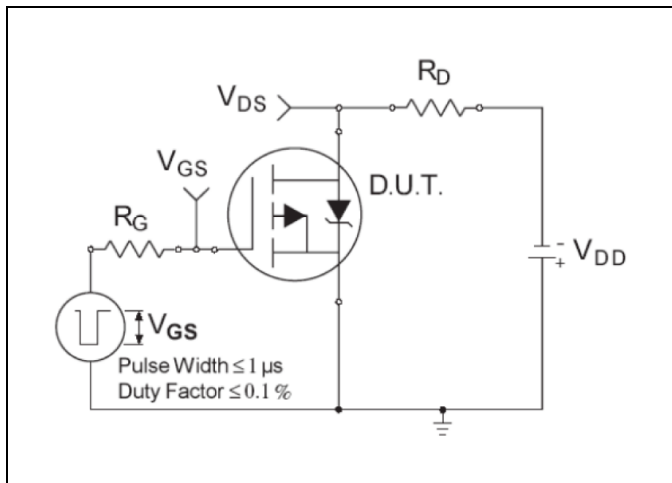

Figure 22 Switching Time Test Circuit

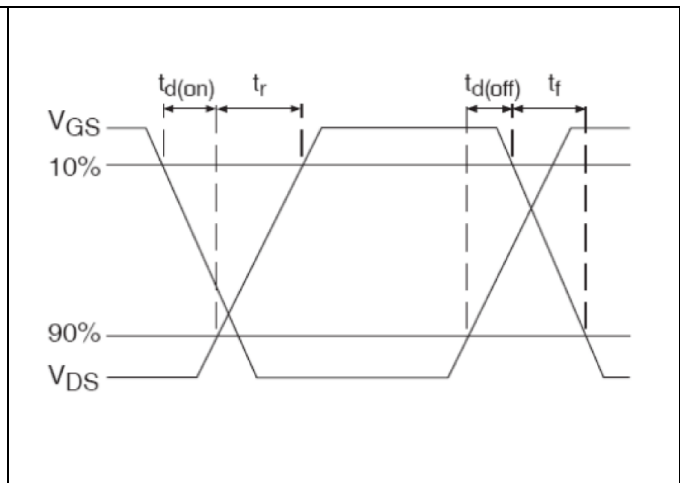

Figure 23 Switching Time Waveforms

IRHYB9A97034CM (JANSR2N7659D5)

Radiation Hardened Power MOSFET Thru-Hole (Low- Ohmic Tabless - TO-257AA)

Package Outline

5 Package Outline

Note: For the most updated package outline, please see the website: [Low Ohmic Tabless - TO-257AA](#)

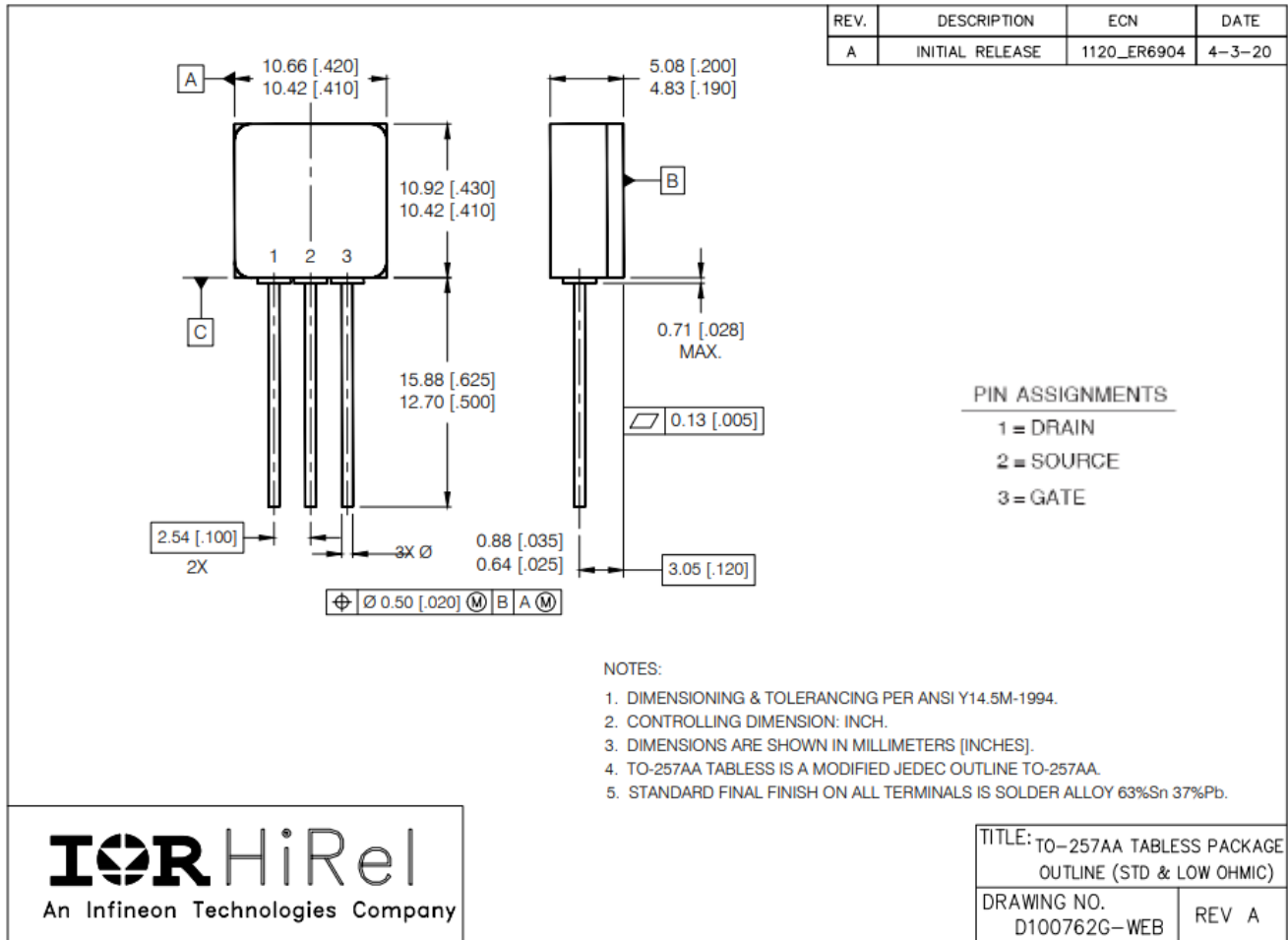

BERYLLIA WARNING PER MIL-PRF-19500

Package containing beryllia shall not be ground, sandblasted, machined, or have other operations performed on them which will produce beryllia or beryllium dust. Furthermore, beryllium oxide packages shall not be placed in acids that will produce fumes containing beryllium.

IRHYB9A97034CM (JANSR2N7659D5)

Radiation Hardened Power MOSFET Thru-Hole (Low- Ohmic Tabless - TO-257AA)

Revision history

Revision history

Document version	Date of release	Description of changes
	11/08/2021	Final datasheet with PD number (PD-97993)

Trademarks

All referenced product or service names and trademarks are the property of their respective owners.

Edition 2021-11-08

Published by

**International Rectifier HiRel Products,
Inc.**

**An Infineon Technologies company
El Segundo, California 90245 USA**

**© 2021 Infineon Technologies AG.
All Rights Reserved.**

**Do you have a question about this
document?**

Email: erratum@infineon.com

Document reference

IMPORTANT NOTICE

The information given in this document shall in no event be regarded as a guarantee of conditions or characteristics ("Beschaffheitsgarantie").

With respect to any examples, hints or any typical values stated herein and/or any information regarding the application of the product, Infineon Technologies hereby disclaims any and all warranties and liabilities of any kind, including without limitation warranties of non-infringement of intellectual property rights of any third party.

In addition, any information given in this document is subject to customer's compliance with its obligations stated in this document and any applicable legal requirements, norms and standards concerning customer's products and any use of the product of Infineon Technologies in customer's applications.

The data contained in this document is exclusively intended for technically trained staff. It is the responsibility of customer's technical departments to evaluate the suitability of the product for the intended application and the completeness of the product information given in this document with respect to such application.

For further information on the product, technology, delivery terms and conditions and prices please contact your nearest Infineon Technologies office (www.infineon.com).

WARNINGS

Due to technical requirements components may contain dangerous substances. For information on the types in question please contact your nearest International Rectifier HiRel Products, Inc., an Infineon Technologies company, office.

International Rectifier HiRel Components may only be used in life-support devices or systems with the expressed written approval of International Rectifier HiRel Products, Inc., an Infineon Technologies company, if failure of such components can reasonably be expected to cause the failure of that life-support device or system, or to affect the safety and effectiveness of that device or system.

Technologies, Infineon Technologies' products may not be used in any applications where a failure of the product or any consequences of the use thereof can reasonably be expected to result in personal injury.

Life support devices or systems are intended to be implanted in the human body, or to support and/or maintain and sustain and/or protect human life. If they fail, it is reasonable to assume that the health of the user or other persons may be endangered.