

IR MOSFET - StrongIRFET™

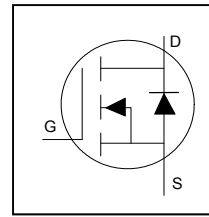

| | |
|--------------------------------|-------------|
| V_{DSS} | 300V |
| R_{DS(on)} typ. | 16mΩ |
| | max |
| I_D | 75A |

Applications

- UPS and Inverter applications
- Half-bridge and full-bridge topologies
- Resonant mode power supplies
- DC/DC and AC/DC converters
- OR-ing and redundant power switches
- Brushed and BLDC Motor drive applications
- Battery powered circuits

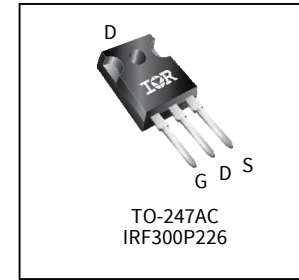

Benefits

- Improved Gate, Avalanche and Dynamic dv/dt Ruggedness
- Fully Characterized Capacitance and Avalanche SOA
- Enhanced body diode dv/dt and di/dt Capability
- Pb-Free ; RoHS Compliant ; Halogen-Free



Halogen-Free



RoHS

| | | |
|----------|----------|----------|
| G | D | S |
| Gate | Drain | Source |

| Base part number | Package Type | Standard Pack | | Orderable Part Number |
|------------------|--------------|---------------|----------|-----------------------|
| | | Form | Quantity | |
| IRF300P226 | TO-247AC | Tube | 25 | IRF300P226 |

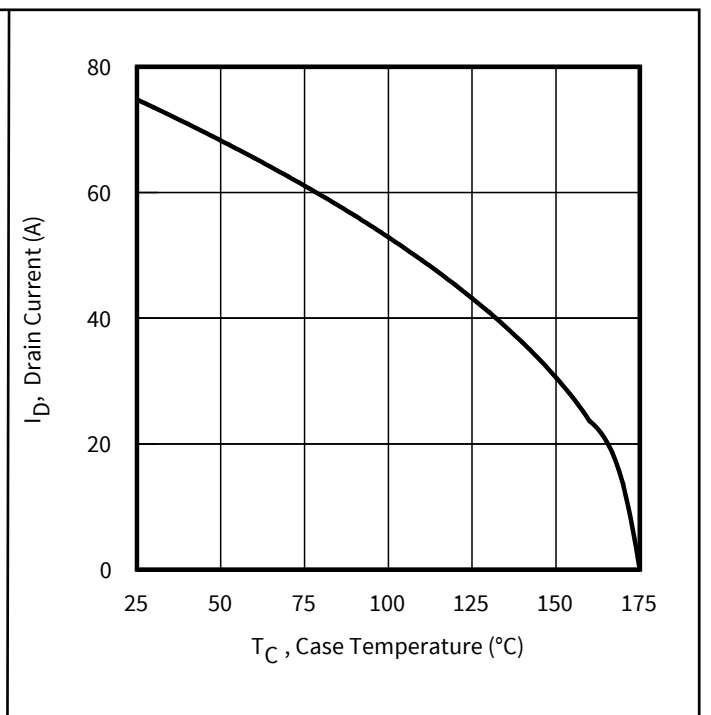
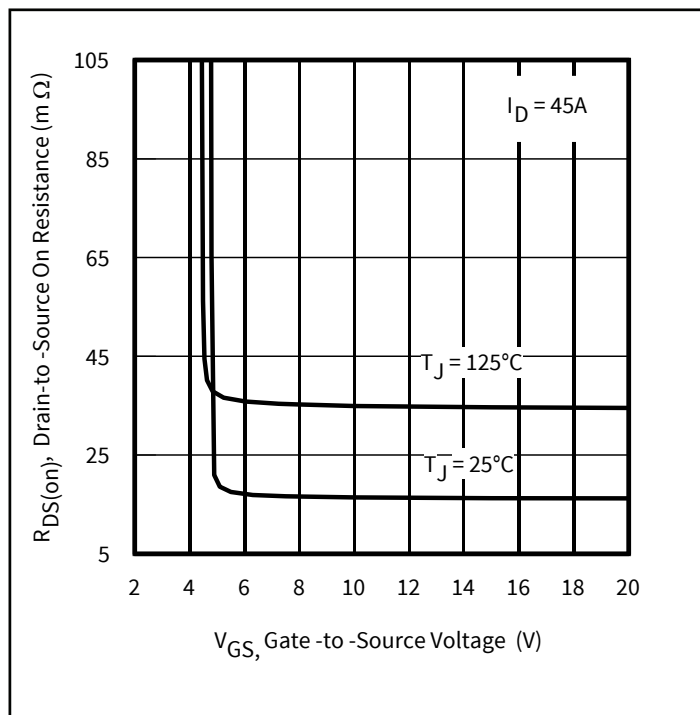

Figure 1 Typical On-Resistance vs. Gate Voltage

Figure 2 Maximum Drain Current vs. Case Temperature

Table of Contents

Applications1

Benefits1

Ordering Table1

Table of Contents2

1 Parameters3

2 Maximum ratings, Thermal, and Avalanche characteristics4

3 Electrical characteristics5

4 Electrical characteristic diagrams6

Package Information14

Qualification Information15

Revision History16

1 Parameters

Table1 Key performance parameters

| Parameter | Values | Units |
|-------------------|--------|------------|
| V_{DS} | 300 | V |
| $R_{DS(on) \max}$ | 19 | m Ω |
| I_D | 75 | A |

2 Maximum ratings and thermal characteristics

Table 2 Maximum ratings (at $T_J=25^\circ\text{C}$, unless otherwise specified)

| Parameter | Symbol | Conditions | Values | Unit |
|---|--------------------|--|---------------------|------|
| Continuous Drain Current | I_D | $T_C = 25^\circ\text{C}$, $V_{GS} @ 10\text{V}$ | 75 | A |
| Continuous Drain Current | I_D | $T_C = 100^\circ\text{C}$, $V_{GS} @ 10\text{V}$ | 53 | |
| Pulsed Drain Current ① | I_{DM} | $T_C = 25^\circ\text{C}$ | 300 | |
| Maximum Power Dissipation | P_D | $T_C = 25^\circ\text{C}$ | 313 | W |
| Linear Derating Factor | | $T_C = 25^\circ\text{C}$ | 2.1 | W/°C |
| Peak Diode Recovery ③ | dv/dt | $T_J = 175^\circ\text{C}$, $I_S = 22\text{A}$, $V_{DS} = 150\text{V}$ | 6.0 | V/ns |
| Gate-to-Source Voltage | V_{GS} | - | ± 20 | V |
| Operating Junction and Storage Temperature Range | T_J T_{STG} | - | -55 to +175 | °C |
| Soldering Temperature, for 10 seconds (1.6mm from case) | - | - | 300 | |
| Mounting Torque, 6-32 or M3 Screw | - | - | 10 lbf·in (1.1 N·m) | - |

Table 3 Thermal characteristics

| Parameter | Symbol | Conditions | Min. | Typ. | Max. | Unit |
|------------------------------------|-----------------|--|------|------|------|------|
| Junction-to-Case ⑦ | $R_{\theta JC}$ | T_J approximately 90°C | - | - | 0.48 | °C/W |
| Case-to-Sink, Flat Greased Surface | $R_{\theta CS}$ | - | - | 0.24 | - | |
| Junction-to-Ambient | $R_{\theta JA}$ | - | - | - | 40 | |

Table 4 Avalanche characteristics

| Parameter | Symbol | Values | Unit |
|---------------------------------|------------------------------|--------------------------|------|
| Single Pulse Avalanche Energy ② | E_{AS} (Thermally limited) | 459 | mJ |
| Avalanche Current ① | I_{AR} | See Fig 16, 17, 23a, 23b | A |
| Repetitive Avalanche Energy ① | E_{AR} | | mJ |

Notes:

- ① Repetitive rating; pulse width limited by max. junction temperature.
- ② Limited by T_{Jmax} , starting $T_J = 25^\circ\text{C}$, $L = 1\text{mH}$, $R_G = 50\Omega$, $I_{AS} = 30\text{A}$, $V_{GS} = 10\text{V}$.
- ③ $I_{SD} \leq 22\text{A}$, $di/dt \leq 1000\text{A}/\mu\text{s}$, $V_{DD} \leq V_{(BR)DSS}$, $T_J \leq 175^\circ\text{C}$.
- ④ Pulse width $\leq 400\mu\text{s}$; duty cycle $\leq 2\%$.
- ⑤ C_{oss} eff. (TR) is a fixed capacitance that gives the same charging time as C_{oss} while V_{DS} is rising from 0 to 80% V_{DSS} .
- ⑥ C_{oss} eff. (ER) is a fixed capacitance that gives the same energy as C_{oss} while V_{DS} is rising from 0 to 80% V_{DSS} .
- ⑦ R_θ is measured at T_J approximately 90°C .

3 Electrical characteristics

Table 5 Static characteristics

| Parameter | Symbol | Conditions | Values | | | Unit |
|--------------------------------------|---------------------------------|---|--------|------|------|------|
| | | | Min. | Typ. | Max. | |
| Drain-to-Source Breakdown Voltage | $V_{(BR)DSS}$ | $V_{GS} = 0V, I_D = 1mA$ | 300 | - | - | V |
| Breakdown Voltage Temp. Coefficient | $\Delta V_{(BR)DSS}/\Delta T_J$ | Reference to 25°C, $I_D = 2.5mA$ ① | - | 0.12 | - | V/°C |
| Static Drain-to-Source On-Resistance | $R_{DS(on)}$ | $V_{GS} = 10V, I_D = 45A$ | - | 16 | 19 | mΩ |
| Gate Threshold Voltage | $V_{GS(th)}$ | $V_{DS} = V_{GS}, I_D = 270\mu A$ | 2.0 | - | 4.0 | V |
| Drain-to-Source Leakage Current | I_{DSS} | $V_{DS} = 240V, V_{GS} = 0V$ | - | - | 10 | μA |
| | | $V_{DS} = 240V, V_{GS} = 0V, T_J = 125^\circ C$ | - | - | 300 | |
| Gate-to-Source Forward Leakage | I_{GSS} | $V_{GS} = 20V$ | - | - | 200 | nA |
| Gate Resistance | R_G | | - | 1.3 | - | Ω |

Table 6 Dynamic characteristics

| Parameter | Symbol | Conditions | Values | | | Unit |
|---|---------------------|--|--------|-------|------|------|
| | | | Min. | Typ. | Max. | |
| Forward Trans conductance | gfs | $V_{DS} = 50V, I_D = 45A$ | 97 | - | - | S |
| Total Gate Charge | Q_g | $I_D = 45A$ $V_{DS} = 150V$ $V_{GS} = 10V$ | - | 127 | 191 | nC |
| Gate-to-Source Charge | Q_{gs} | | - | 44 | - | |
| Gate-to-Drain Charge | Q_{gd} | | - | 24 | - | |
| Total Gate Charge Sync. ($Q_g - Q_{gd}$) | Q_{sync} | | - | 103 | - | |
| Turn-On Delay Time | $t_{d(on)}$ | $V_{DD} = 150V$ | - | 25 | - | ns |
| Rise Time | t_r | $I_D = 45A$ | - | 44 | - | |
| Turn-Off Delay Time | $t_{d(off)}$ | $R_G = 2.7\Omega$ | - | 79 | - | |
| Fall Time | t_f | $V_{GS} = 10V$ | - | 32 | - | |
| Input Capacitance | C_{iss} | $V_{GS} = 0V$ | - | 10030 | - | pF |
| Output Capacitance | C_{oss} | $V_{DS} = 50V$ | - | 863 | - | |
| Reverse Transfer Capacitance | C_{rss} | $f = 1.0MHz$, See Fig.7 | - | 3.8 | - | |
| Effective Output Capacitance (Energy Related) | $C_{oss\ eff.(ER)}$ | $V_{GS} = 0V, V_{DS} = 0V$ to 240V ⑥ | - | 552 | - | |
| Output Capacitance (Time Related) | $C_{oss\ eff.(TR)}$ | $V_{GS} = 0V, V_{DS} = 0V$ to 240V ⑤ | - | 961 | - | |

Table 7 Reverse Diode

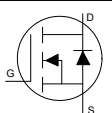
| Parameter | Symbol | Conditions | Values | | | Unit |
|--|-----------|---|--------|------|------|------|
| | | | Min. | Typ. | Max. | |
| Continuous Source Current (Body Diode) | I_S | MOSFET symbol showing the integral reverse p-n junction diode.  | - | - | 75 | A |
| Pulsed Source Current (Body Diode) ① | I_{SM} | | - | - | 300 | |
| Diode Forward Voltage | V_{SD} | $T_J = 25^\circ C, I_S = 45A, V_{GS} = 0V$ ④ | - | - | 1.2 | V |
| Reverse Recovery Time | t_{rr} | $T_J = 25^\circ C$ | - | 156 | - | ns |
| | | $T_J = 125^\circ C$ | - | 215 | - | |
| Reverse Recovery Charge | Q_{rr} | $T_J = 25^\circ C$ | - | 521 | - | nC |
| | | $T_J = 125^\circ C$ | - | 1145 | - | |
| Reverse Recovery Current | I_{RRM} | $T_J = 25^\circ C$ | - | 5.0 | - | A |
| | | $T_J = 125^\circ C$ | - | 7.8 | - | |

4 Electrical characteristic diagrams

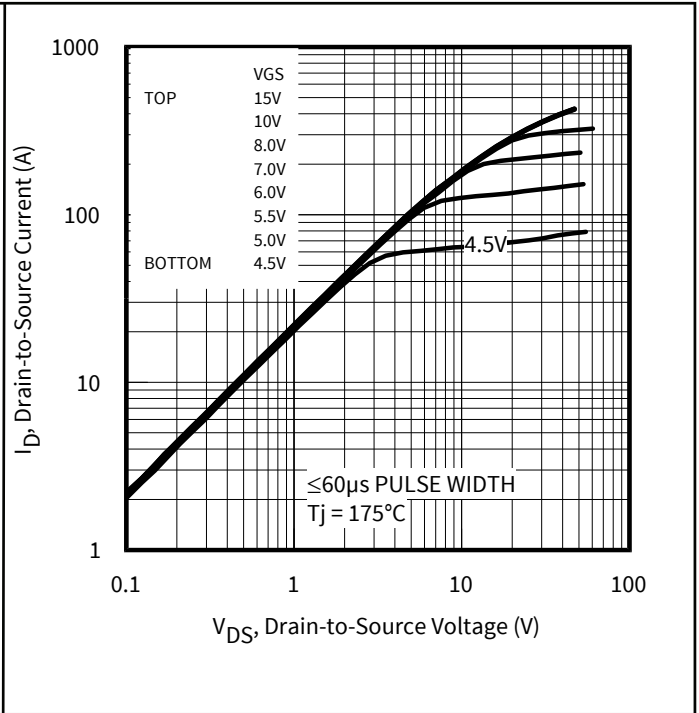
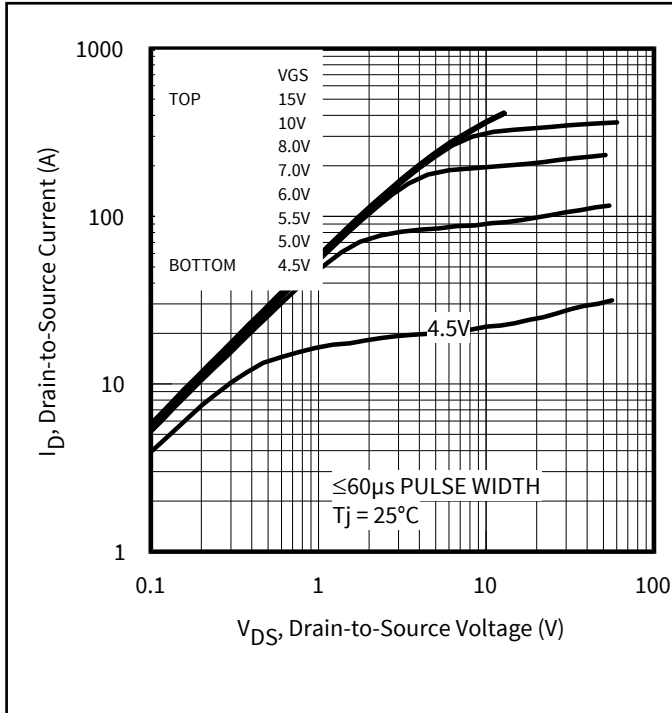

Figure 3 Typical Output Characteristics

Figure 4 Typical Output Characteristics

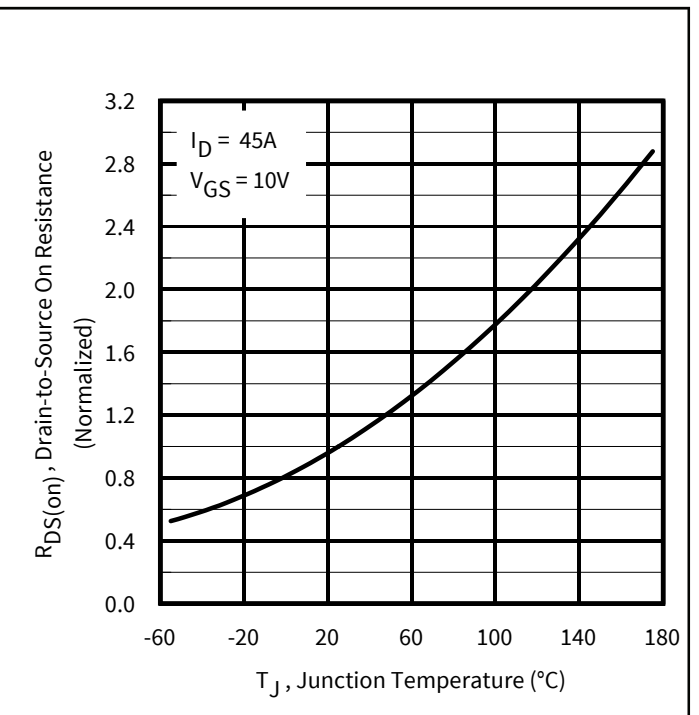
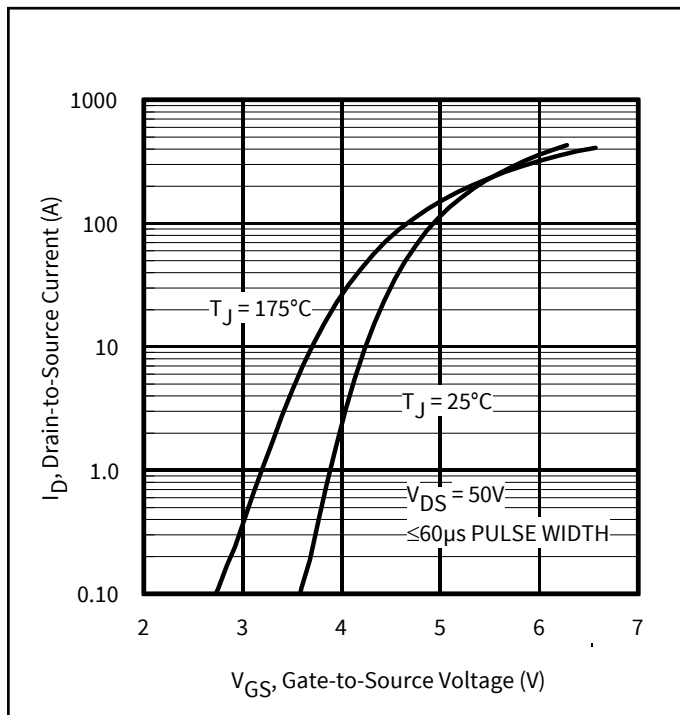

Figure 5 Typical Transfer Characteristics

Figure 6 Normalized On-Resistance vs. Temperature

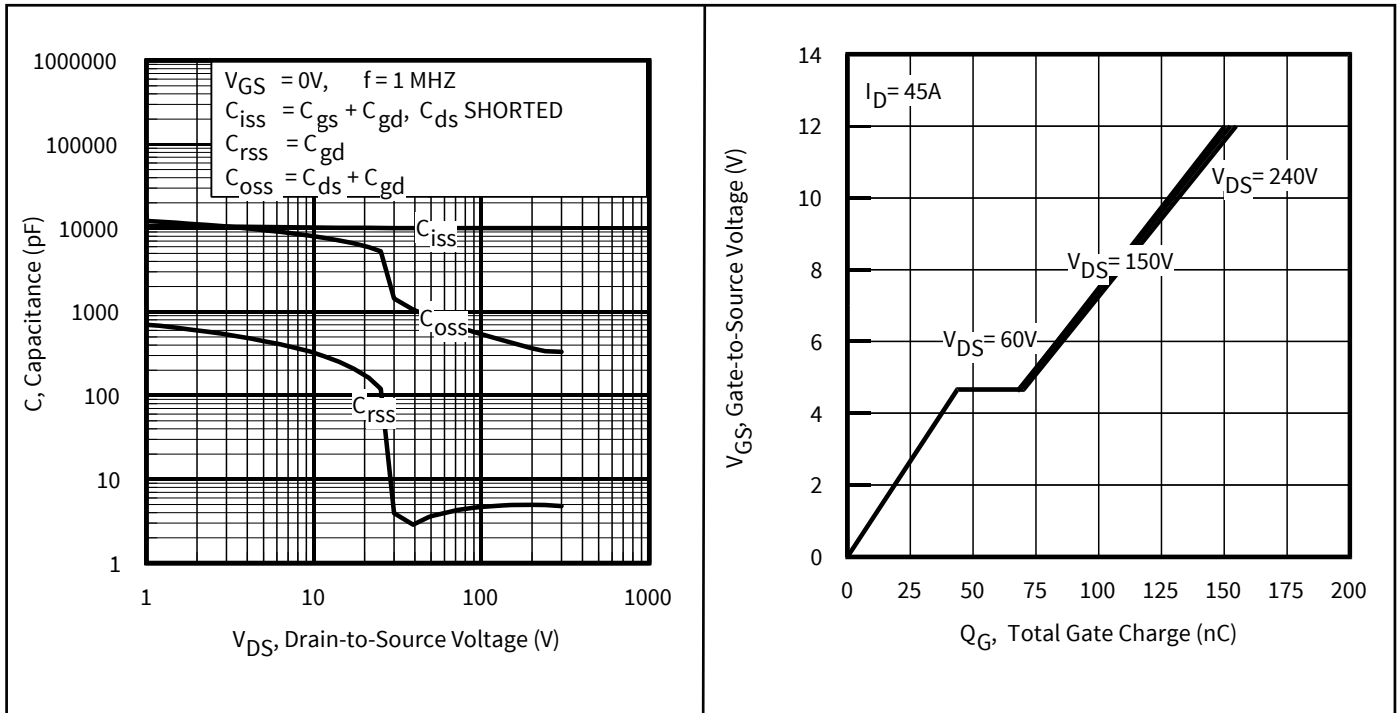

Figure 7 Typical Capacitance vs. Drain-to-Source Voltage

Figure 8 Typical Gate Charge vs. Gate-to-Source Voltage

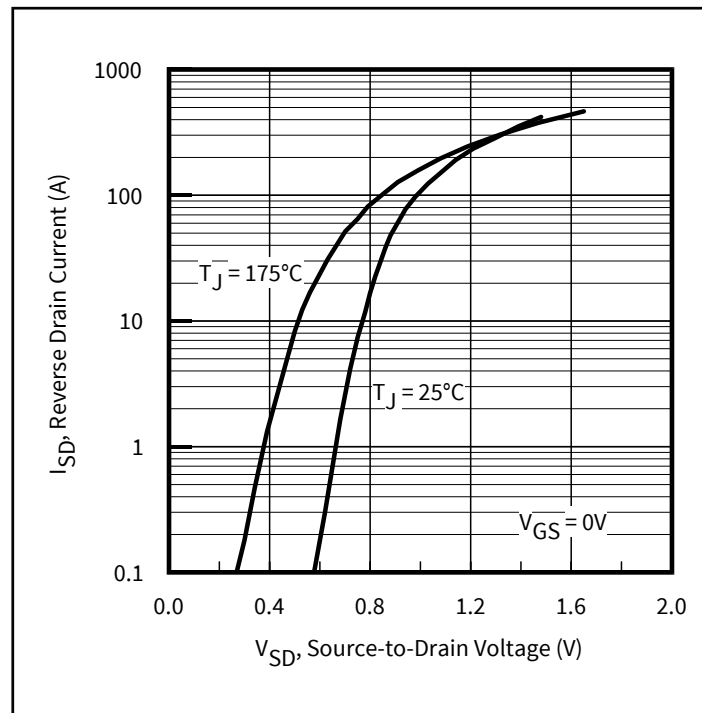

Figure 9 Typical Source-Drain Diode Forward Voltage

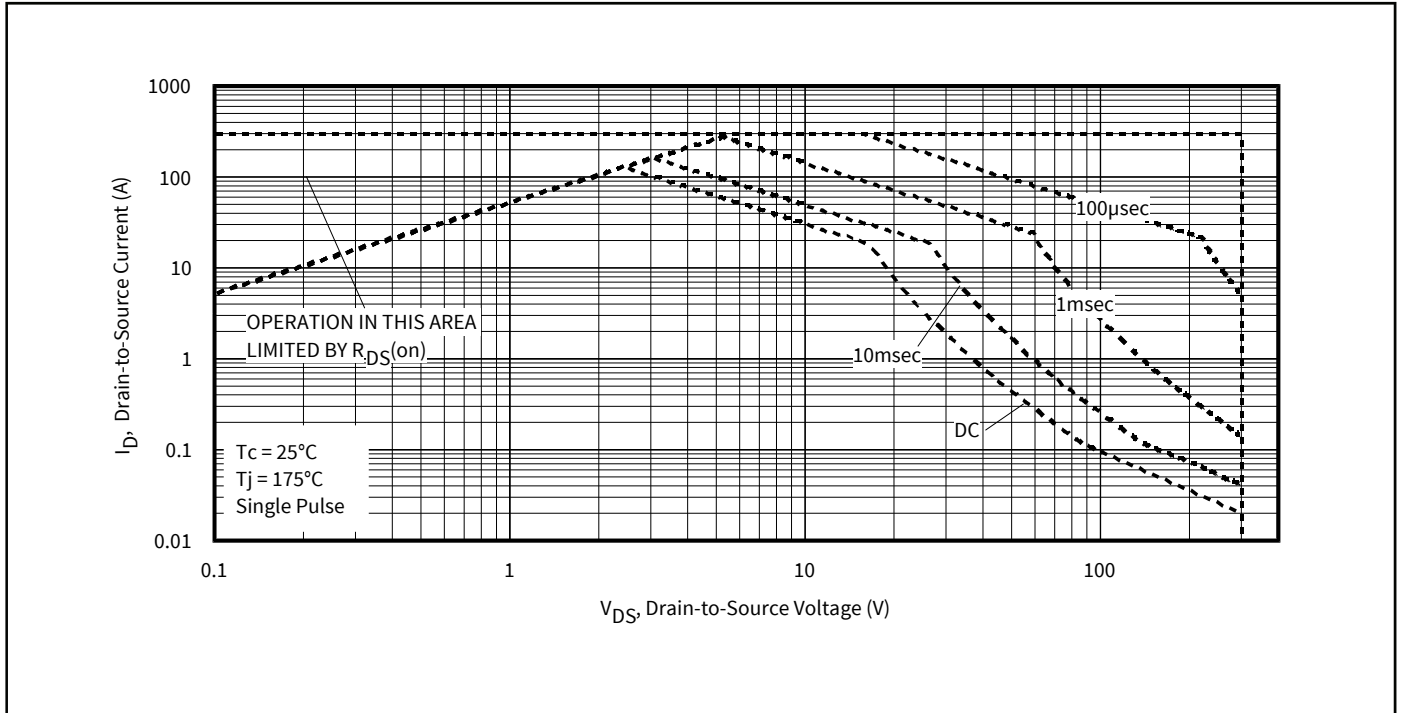

Figure 10 Maximum Safe Operating Area

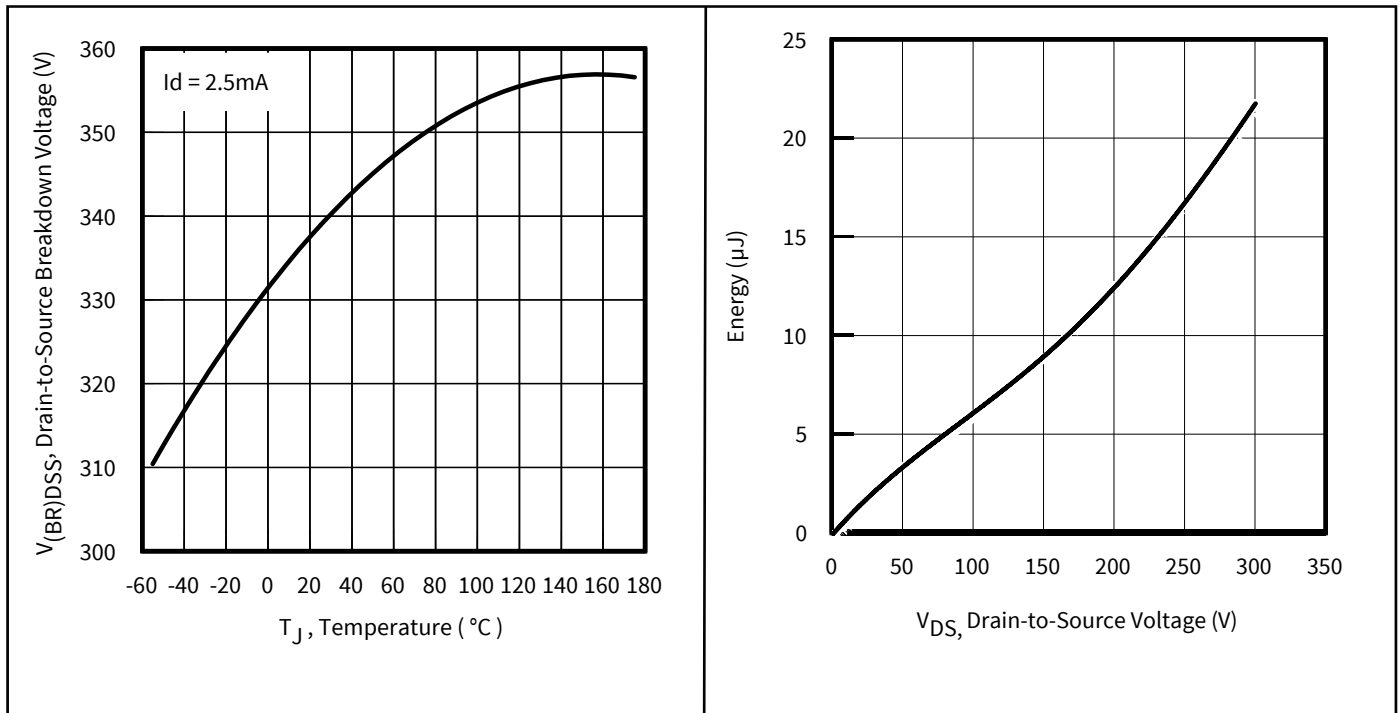

Figure 11 Drain-to-Source Breakdown Voltage

Figure 12 Typical Coss Stored Energy

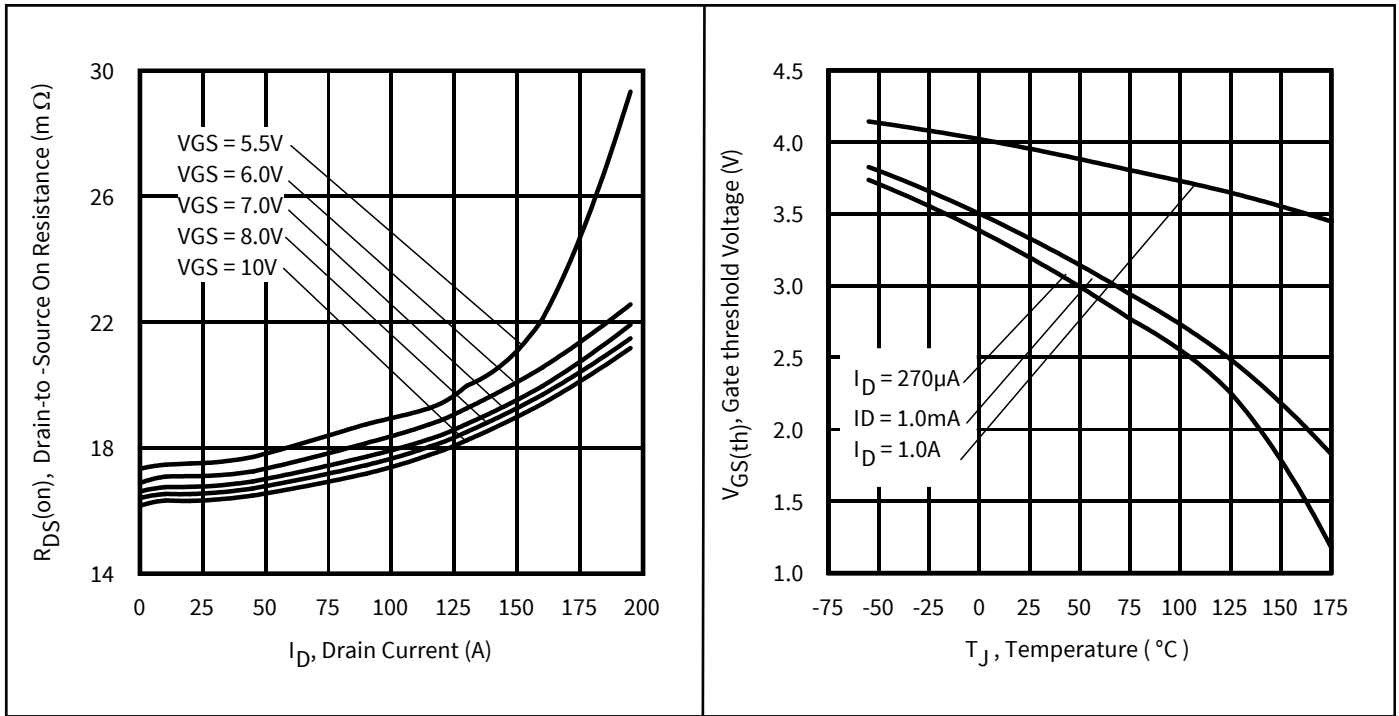

Figure 13 Typical On-Resistance vs. Drain Current

Figure 14 Threshold Voltage vs. Temperature

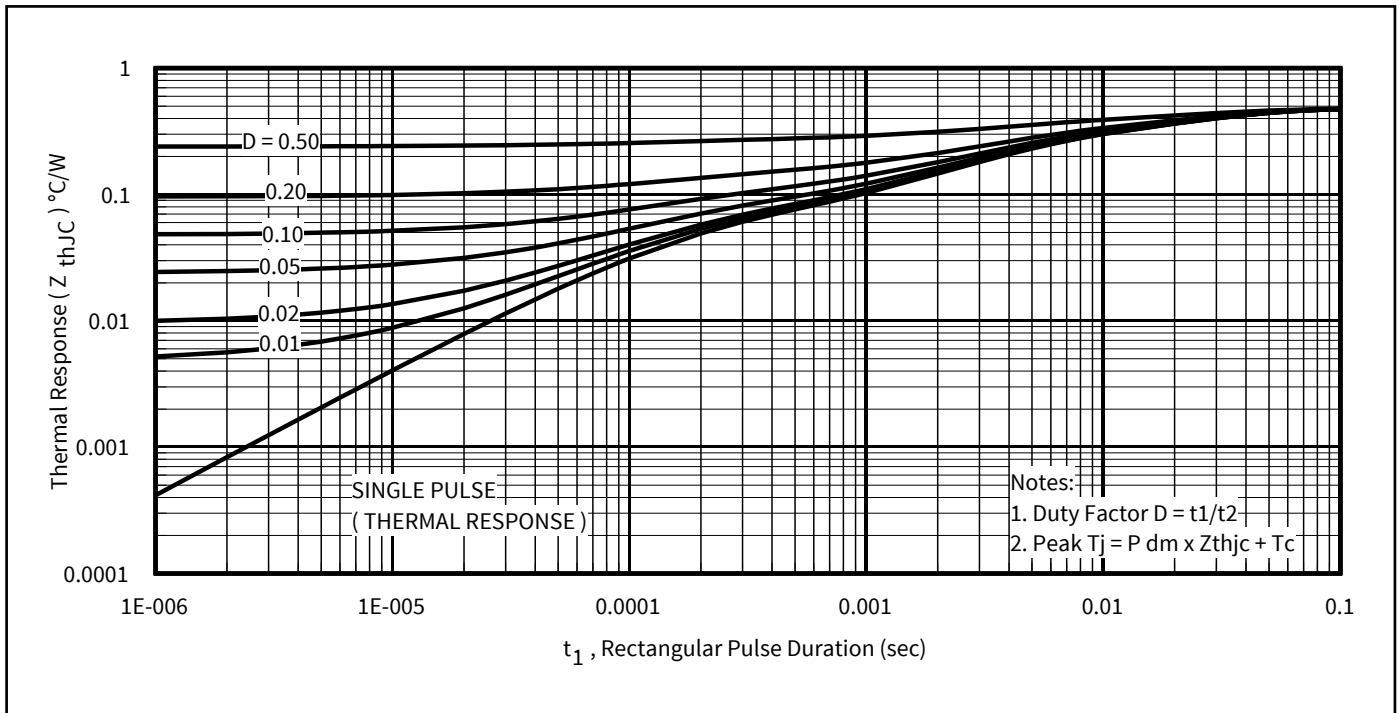

Figure 15 Maximum Effective Transient Thermal Impedance, Junction-to-Case

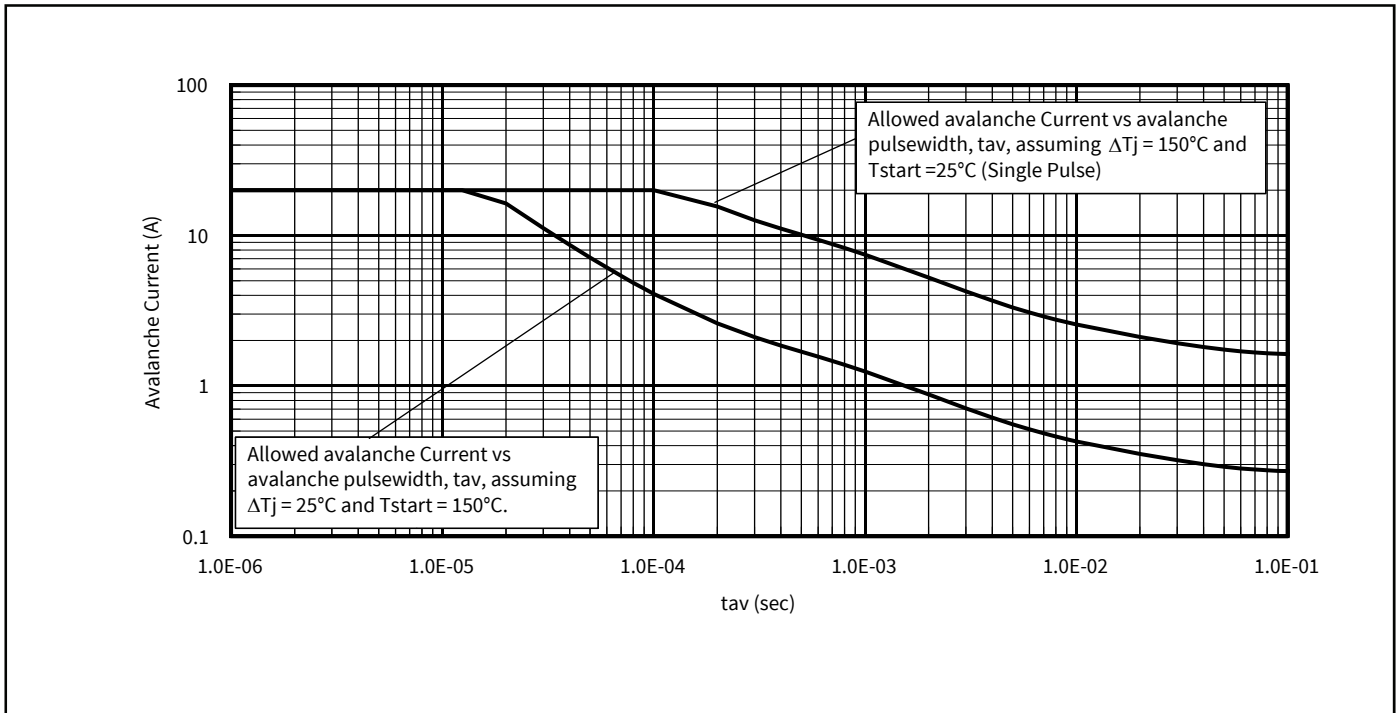
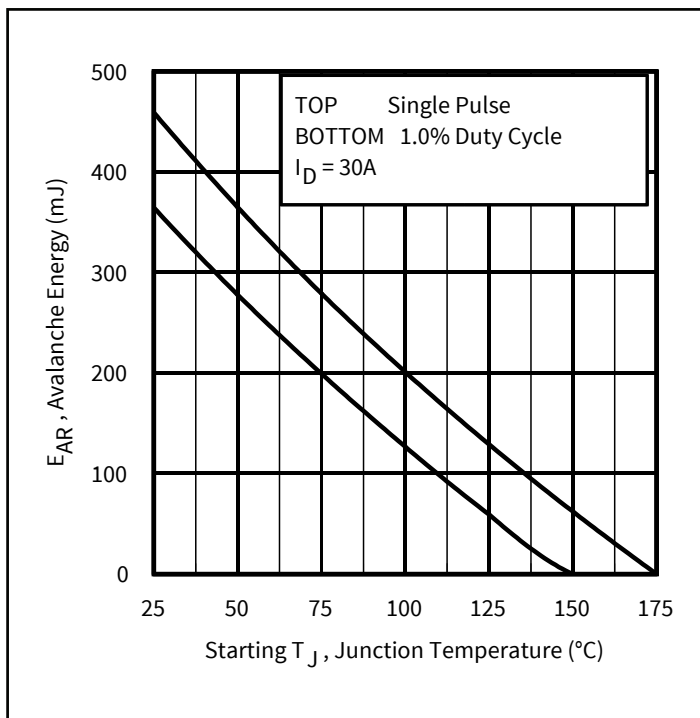

Figure 16 Avalanche Current vs. Pulse Width



Notes on Repetitive Avalanche Curves, Figures 16, 17:
 (For further info, see AN-1005 at www.infineon.com)

1. Avalanche failures assumption:
 Purely a thermal phenomenon and failure occurs at a temperature far in excess of T_{jmax} . This is validated for every part type.
2. Safe operation in Avalanche is allowed as long as T_{jmax} is not exceeded.
3. Equation below based on circuit and waveforms shown in Figures 23a, 23b.
4. $P_{D(ave)}$ = Average power dissipation per single avalanche pulse.
5. BV = Rated breakdown voltage (1.3 factor accounts for voltage increase during avalanche).
6. I_{av} = Allowable avalanche current.
7. ΔT = Allowable rise in junction temperature, not to exceed T_{jmax} (assumed as 25°C in Figure 15, 16).
 t_{av} = Average time in avalanche.
 D = Duty cycle in avalanche = $t_{av} \cdot f$
 $Z_{thJC}(D, t_{av})$ = Transient thermal resistance, see Figures 14)
 $P_{D(ave)} = 1/2 (1.3 \cdot BV \cdot I_{av}) = \Delta T / Z_{thJC}$
 $I_{av} = 2\Delta T / [1.3 \cdot BV \cdot Z_{th}]$
 $E_{AS(AR)} = P_{D(ave)} \cdot t_{av}$

Figure 17 Maximum Avalanche Energy vs. Temperature

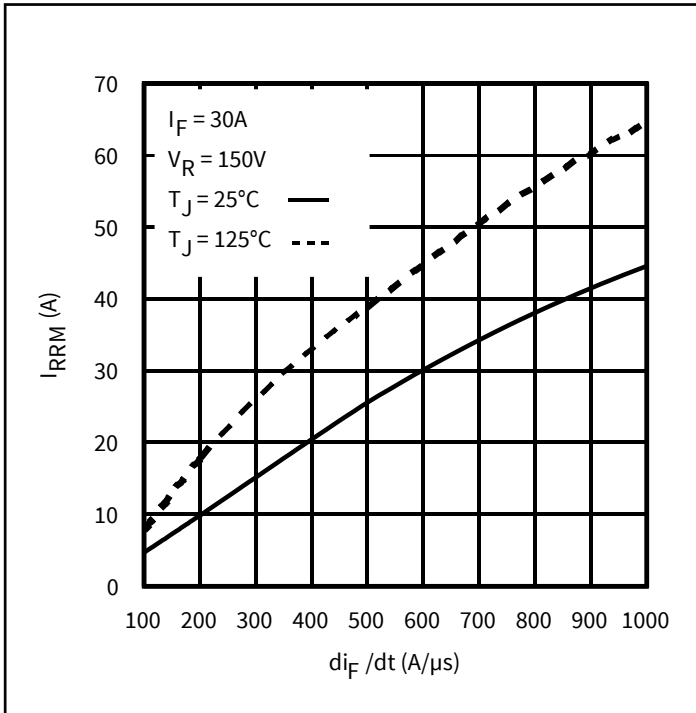

Figure 18 Typical Recovery Current vs. di_F/dt

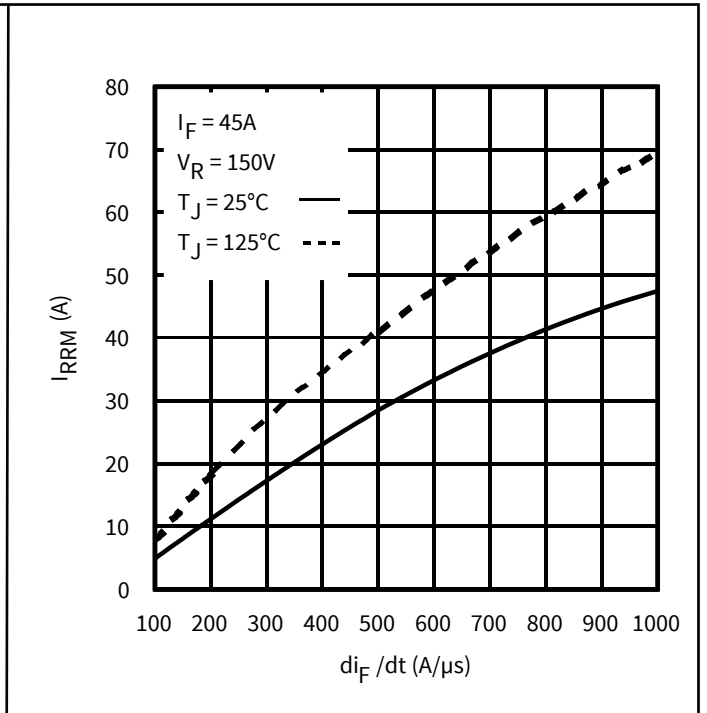

Figure 19 Typical Recovery Current vs. di_F/dt

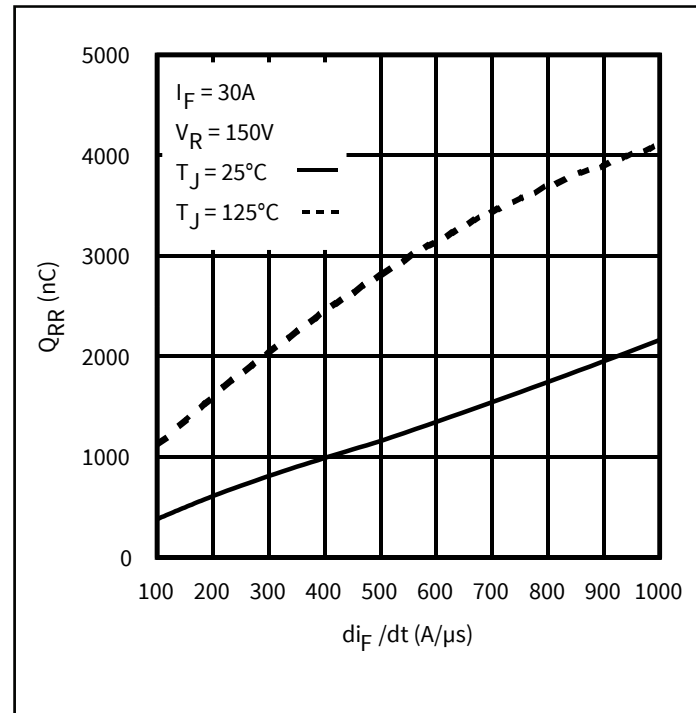

Figure 20 Typical Stored Charge vs. di_F/dt

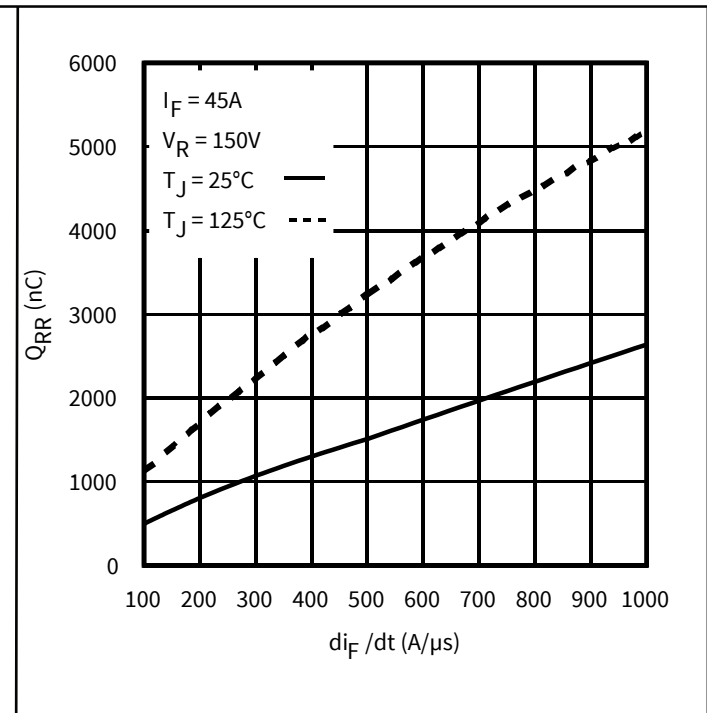

Figure 21 Typical Stored Charge vs. di_F/dt

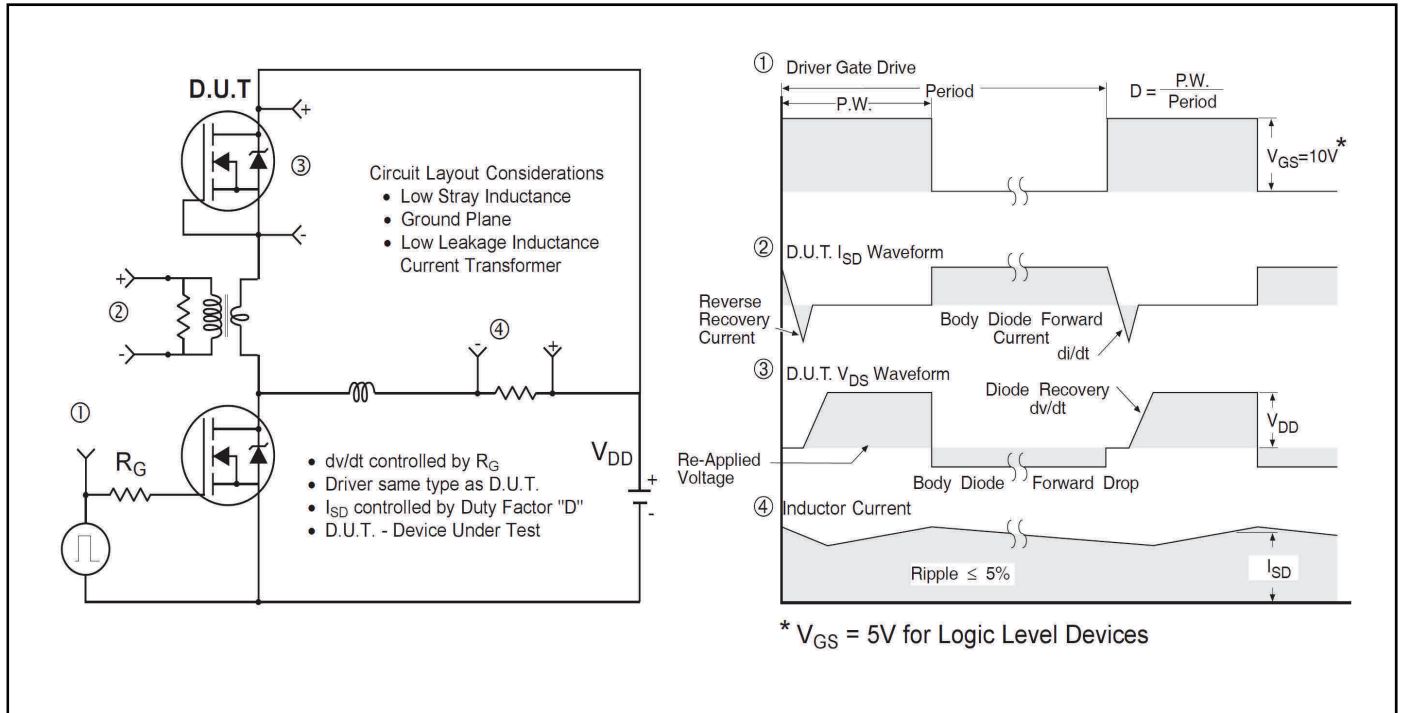

Figure 22 Peak Diode Recovery dv/dt Test Circuit for N-Channel HEXFET™ Power MOSFETs

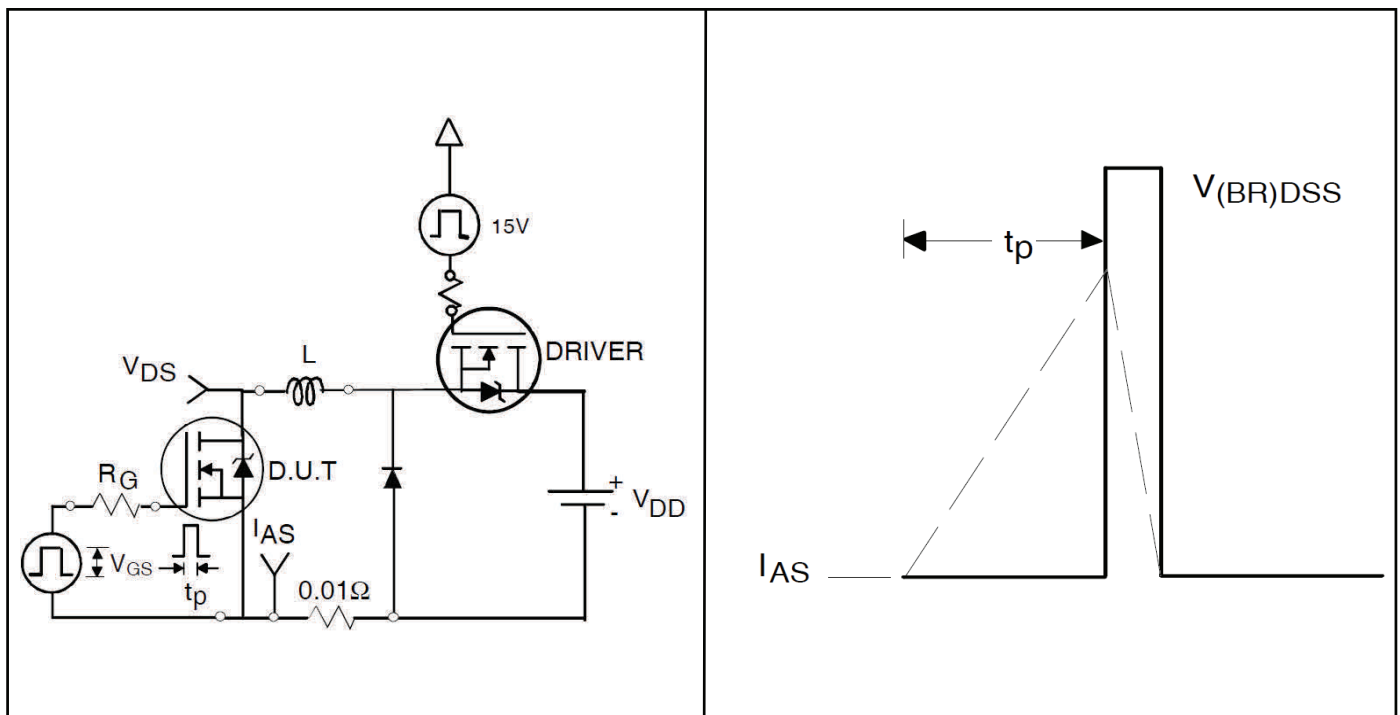

Figure 23a Unclamped Inductive Test Circuit

Figure 23b Unclamped Inductive Waveforms

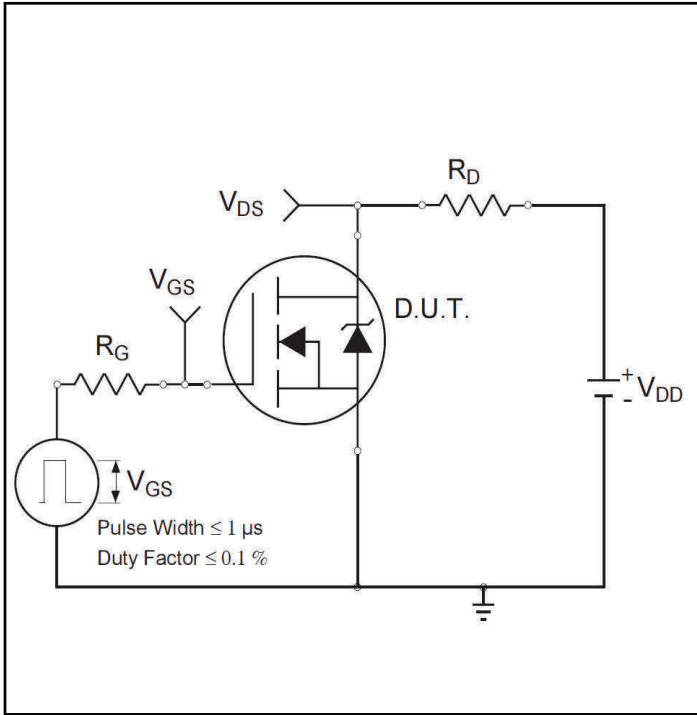

Figure 24a Switching Time Test Circuit

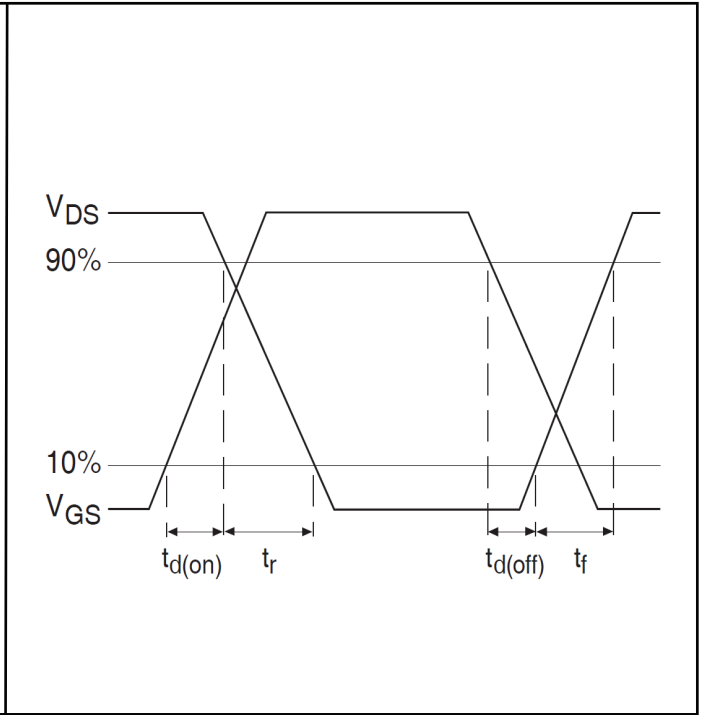

Figure 24b Switching Time Waveforms

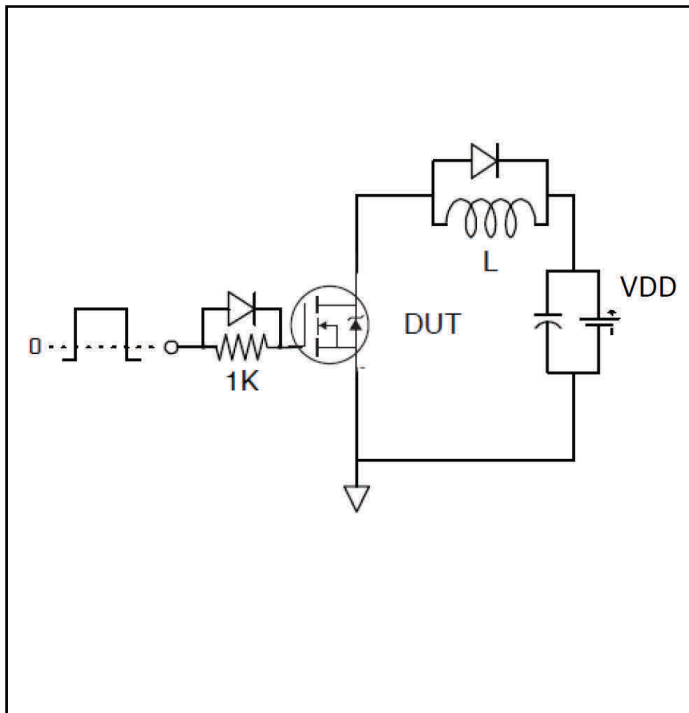

Figure 25a Gate Charge Test Circuit

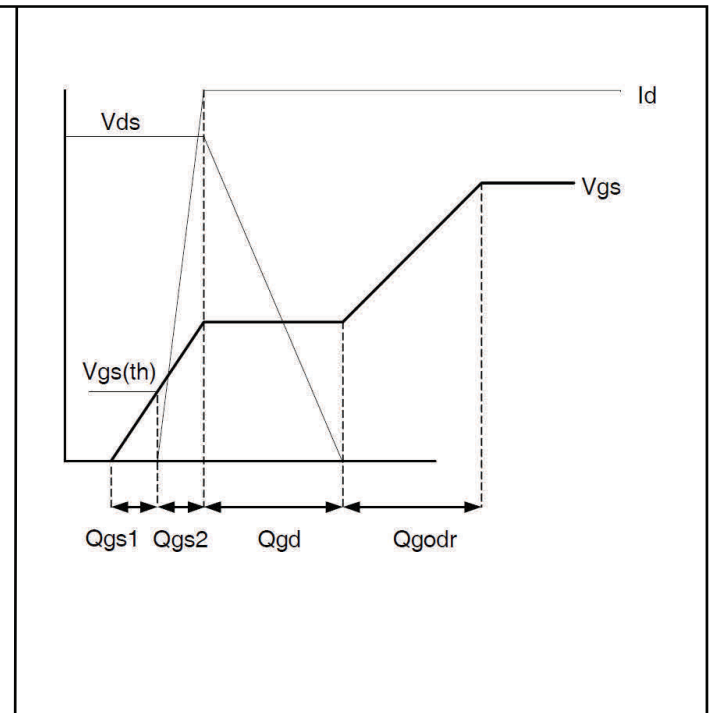
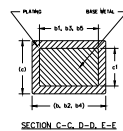
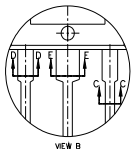
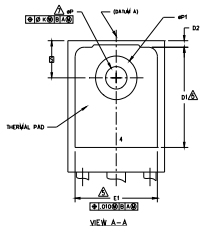
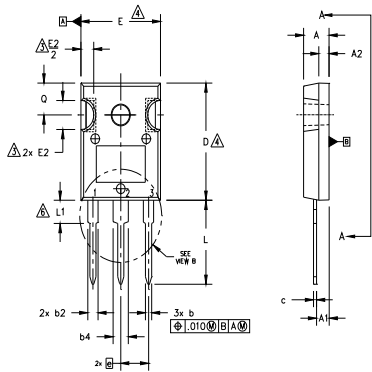

Figure 25b Gate Charge Waveform

5 Package Information

TO-247AC Package Outline (Dimensions are shown in millimeters (inches))



NOTES:

1. DIMENSIONING AND TOLERANCING AS PER ASME Y14.5M 1994.
2. DIMENSIONS ARE SHOWN IN INCHES.
3. CONTOUR OF SLOT OPTIONAL.
4. DIMENSION D & E DO NOT INCLUDE MOLD FLASH. MOLD FLASH SHALL NOT EXCEED .005" (0.127) PER SIDE. THESE DIMENSIONS ARE MEASURED AT THE OUTERMOST EXTREMES OF THE PLASTIC BODY.
5. THERMAL PAD CONTOUR OPTIONAL WITHIN DIMENSIONS D1 & E1.
6. LEAD FINISH UNCONTROLLED IN L1.
7. ϕP TO HAVE A MAXIMUM DRAFT ANGLE OF 1.5 ° TO THE TOP OF THE PART WITH A MAXIMUM HOLE DIAMETER OF .154 INCH.
8. OUTLINE CONFORMS TO JEDEC OUTLINE TO-247AC .

| SYMBOL | DIMENSIONS | | | | NOTES |
|-----------|------------|------|-------------|-------|-------|
| | INCHES | | MILLIMETERS | | |
| | MIN. | MAX. | MIN. | MAX. | |
| A | .183 | .209 | 4.65 | 5.31 | |
| A1 | .087 | .102 | 2.21 | 2.59 | |
| A2 | .059 | .098 | 1.50 | 2.49 | |
| b | .039 | .055 | 0.99 | 1.40 | |
| b1 | .039 | .053 | 0.99 | 1.35 | |
| b2 | .065 | .094 | 1.65 | 2.39 | |
| b3 | .065 | .092 | 1.65 | 2.34 | |
| b4 | .102 | .135 | 2.59 | 3.43 | |
| b5 | .102 | .133 | 2.59 | 3.38 | |
| c | .015 | .035 | 0.38 | 0.89 | |
| c1 | .015 | .033 | 0.38 | 0.84 | |
| D | .776 | .815 | 19.71 | 20.70 | 4 |
| D1 | .515 | - | 13.08 | - | 5 |
| D2 | .020 | .053 | 0.51 | 1.35 | |
| E | .602 | .625 | 15.29 | 15.87 | 4 |
| E1 | .530 | - | 13.46 | - | |
| E2 | .178 | .216 | 4.52 | 5.49 | |
| e | .215 BSC | | 5.46 BSC | | |
| ϕk | .010 | | 0.25 | | |
| L | .559 | .634 | 14.20 | 16.10 | |
| L1 | .146 | .169 | 3.71 | 4.29 | |
| ϕP | .140 | .144 | 3.56 | 3.66 | |
| $\phi P1$ | - | .291 | - | 7.39 | |
| Q | .209 | .224 | 5.31 | 5.69 | |
| S | .217 BSC | | 5.51 BSC | | |

LEAD ASSIGNMENTS

HEXFET

- 1.- GATE
- 2.- DRAIN
- 3.- SOURCE
- 4.- DRAIN

IGBTs, CoPACK

- 1.- GATE
- 2.- COLLECTOR
- 3.- EMITTER
- 4.- COLLECTOR

DIODES

- 1.- ANODE/OPEN
- 2.- CATHODE
- 3.- ANODE

TO-247AC Part Marking Information

EXAMPLE: THIS IS AN IRFPE30
WITH ASSEMBLY
LOT CODE 5657
ASSEMBLED ON WW 35, 2001
IN THE ASSEMBLY LINE "H"

Note: "P" in assembly line position
indicates "Lead-Free"

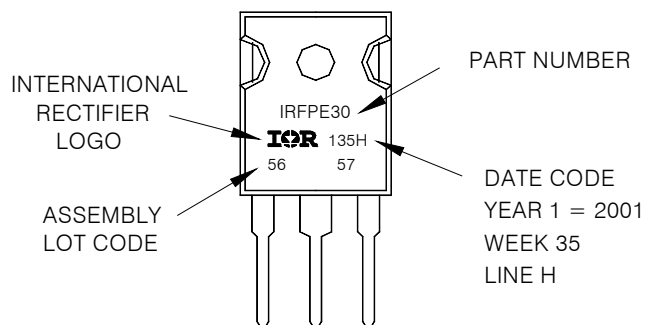

TO-247AC package is not recommended for Surface Mount Application.

6 Qualification Information

Qualification Information

| | | |
|-----------------------------------|-------------------------------------|-----|
| Qualification Level | Industrial (per JEDEC JESD47F) † | |
| Moisture Sensitivity Level | TO-247AC | N/A |
| RoHS Compliant | Yes | |

† Applicable version of JEDEC standard at the time of product release.

Revision History**Major changes since the last revision**

| Page or Reference | Revision | Date | Description of changes |
|--------------------------|-----------------|-------------|---|
| All pages | 2.0 | 2017-11-14 | <ul style="list-style-type: none">• First release data sheet. |

Trademarks of Infineon Technologies AG

μ HVIC™, μ IPM™, μ PFC™, AU-ConvertIR™, AURIX™, C166™, CanPAK™, CIPOS™, CIPURSE™, CoolDP™, CoolGaN™, COOLiR™, CoolMOS™, CoolSET™, CoolSiC™, DAVE™, DI-POL™, DirectFET™, DrBlade™, EasyPIM™, EconoBRIDGE™, EconoDUAL™, EconoPACK™, EconoPIM™, EiceDRIVER™, eupec™, FCOS™, GaNpowIR™, HEXFET™, HITFET™, HybridPACK™, iMOTION™, IRAM™, ISOFACE™, IsoPACK™, LEDrivIR™, LITIX™, MIPAQ™, ModSTACK™, my-d™, NovalithIC™, OPTIGA™, OptiMOS™, ORIGA™, PowIRaudio™, PowIRstage™, PrimePACK™, PrimeSTACK™, PROFET™, PRO-SIL™, RASIC™, REAL3™, SmartLEWIS™, SOLID FLASH™, SPOC™, StrongIRFET™, SupIRBuck™, TEMPFET™, TRENCHSTOP™, TriCore™, UHVIC™, XHP™, XMC™

Trademarks updated November 2015

Other Trademarks

All referenced product or service names and trademarks are the property of their respective owners.

IMPORTANT NOTICE

Edition 2015-05-06
Published by
Infineon Technologies AG
81726 Munich, Germany

© 2016 Infineon Technologies AG.
All Rights Reserved.

Do you have a question about this document?

Email: erratum@infineon.com

Document reference

The information given in this document shall in no event be regarded as a guarantee of conditions or characteristics ("Beschaffenheitsgarantie").

With respect to any examples, hints or any typical values stated herein and/or any information regarding the application of the product, Infineon Technologies hereby disclaims any and all warranties and liabilities of any kind, including without limitation warranties of non-infringement of intellectual property rights of any third party.

In addition, any information given in this document is subject to customer's compliance with its obligations stated in this document and any applicable legal requirements, norms and standards concerning customer's products and any use of the product of Infineon Technologies in customer's applications.

The data contained in this document is exclusively intended for technically trained staff. It is the responsibility of customer's technical departments to evaluate the suitability of the product for the intended application and the completeness of the product information given in this document with

For further information on the product, technology, delivery terms and conditions and prices please contact your nearest Infineon Technologies office (www.infineon.com).

WARNINGS

Due to technical requirements products may contain dangerous substances. For information on the types in question please contact your nearest Infineon Technologies office.

Except as otherwise explicitly approved by Infineon Technologies in a written document signed by authorized representatives of Infineon Technologies, Infineon Technologies' products may not be used in any applications where a failure of the product or any consequences of the use thereof can reasonably be expected to result in personal injury.