

Home Appliances Selection Guide

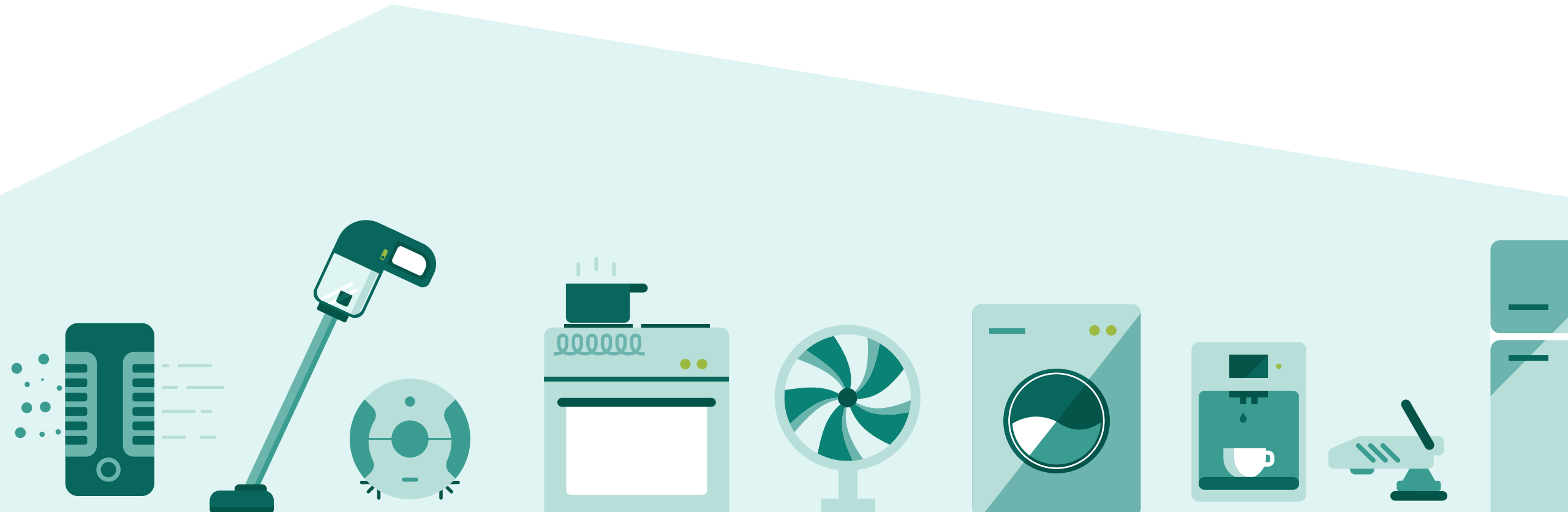

The ultimate buyer's guide: Product recommendations and complete overview for your designs

www.infineon.com/homeappliances



Content

1 Introduction	3
2 Trends and design considerations in Home Appliances	4
3 Infineon's semiconductor expertise in Home Appliances	6
4 Product recommendations per application category	9
4.1 Air purifier	10
4.2 Ceiling fan	14
4.3 Coffee maker and grinder	20
4.4 Cordless vacuum cleaners	26
4.5 Induction cooking	33
4.6 Laundry machines & tumble dryers	40
4.7 Refrigerators & freezers	47

1 Introduction

Welcome to the ultimate Home Appliance Selection Guide!

In today's rapidly evolving technological landscape, home appliances are becoming more advanced, efficient, and interconnected than ever before. This guide is designed to help you navigate the myriad of choices available, providing comprehensive information and expert recommendations to make informed decisions for your product design.

As we venture through the various categories of home appliances, from ceiling fans to tumble dryers, we'll explore the latest trends and design considerations shaping the future of intelligent living.

Energy efficiency, sustainability, and more convenient smart home integration are now at the forefront of appliance design, enhancing our comfort while contributing to a greener planet.

A significant aspect of this guide is the spotlight on Infineon Technologies' expertise in semiconductor solutions. Infineon plays an essential role in the home appliance industry, offering cutting-edge technologies that drive performance, reliability, and innovation. Whether it's through motor control, power management, or sensor and connectivity technologies, Infineon's contributions are pivotal in making appliances smarter, more efficient and market competitive.

Join us as we delve into each appliance category, uncovering the key features and benefits to look for, the latest technological advancements, and the best products available today on the market. We aim to equip you with the knowledge and insights to choose products and solutions that best suit your requirements and enhance your design process.

Let's start this journey and discover the perfect home appliance solutions for a modern, efficient, and comfortable home.

2 Trends and design considerations in Home Appliances

In the recent years, spending more time at home, had a huge influence on how consumers think about their homes. Hence, the home appliance landscape is reshaped by strong demands for ease of use, interoperability and connectivity. This chapter explores the latest trends and design considerations in the domain.



1. Energy Efficiency and Sustainability

Energy efficiency has become a paramount focus in the design of modern home appliances. Manufacturers must comply with government regulations and are increasingly adopting eco-friendly practices, by integrating technologies that reduce power consumption and minimize environmental impact. Appliances such as induction cooktops, energy-efficient refrigerators, and smart washers and dryers are leading the way in this green revolution.



2. Smart Home Integration

The rise of the smart home ecosystem is perhaps the most significant trend in home appliance design. With the advent of the Internet of Things (IoT) and standards like Matter, appliances are now interconnected, offering seamless integration and control through smartphones and voice assistants. This connectivity allows for greater convenience, remote monitoring, and enhanced functionality, transforming traditional appliances into intelligent assistants that cater to our everyday needs.



3. User Experience and Ergonomics

Modern appliances are designed with the user in mind, focusing on intuitive interfaces and ergonomic designs. Touchscreen controls, voice commands, and app-based interactions are becoming standard features, enhancing usability and accessibility. Additionally, appliances are being designed to fit seamlessly into contemporary home aesthetics, combining functionality with style.

Engineering challenges in Smart Home and Intelligent Appliances

While the trend towards smarter, more efficient appliances is clear, several engineering challenges must be addressed to fully realize the potential of these innovations.

1. Interoperability and Standardization

One of the key challenges in the smart home domain is interoperability – ensuring that devices from different manufacturers can communicate and work together seamlessly. Standardization of communication protocols and interfaces is essential to overcome this hurdle, enabling a cohesive and user-friendly smart home experience.

2. Security and Privacy

With the increasing connectivity of home appliances comes the heightened risk of cyber threats. Ensuring robust security measures to protect user data and privacy is a critical concern. Manufacturers must implement advanced encryption, secure authentication protocols, and regular software updates to safeguard against potential breaches.

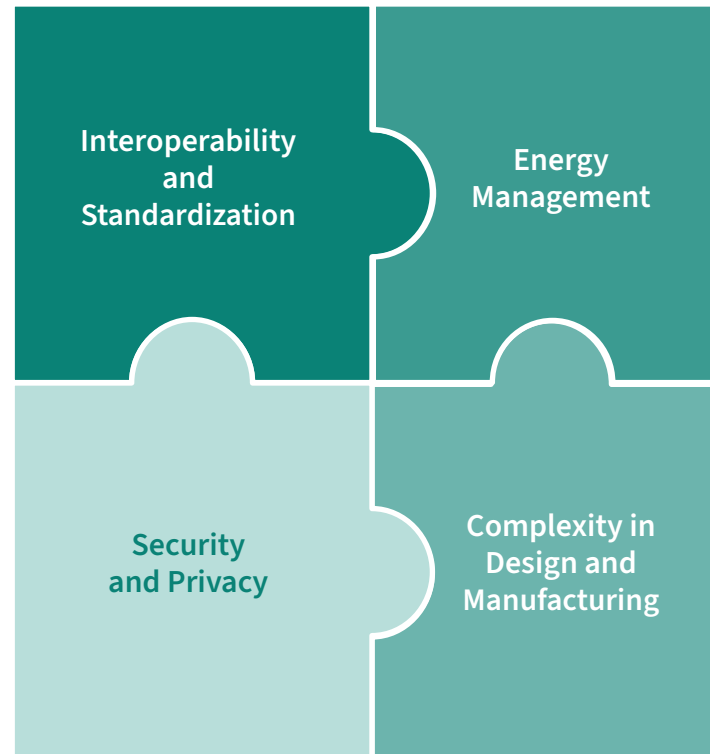

3. Energy Management

As appliances become more intelligent, their energy demands also increase. Effective energy management solutions are required to balance performance with power consumption. This includes the development of more efficient power supplies and motor control, advanced battery technologies for cordless devices, and intelligent energy management systems that optimize usage based on contextual in-field data.

4. Complexity in Design and Manufacturing

Integrating advanced technologies like sensors, microcontrollers, and communication modules into home appliances adds complexity to the design and manufacturing processes. Achieving high levels of reliability and performance while maintaining cost-effectiveness is a significant engineering challenge that requires innovative solutions and meticulous quality control. All of this, while staying market competitive with efficient time-to-market.

3 Infineon's semiconductor expertise in Home Appliances

In the evolving realm of home appliances, Infineon Technologies stands as a beacon of innovation and reliability. Leveraging their profound expertise in system understanding and quality standards, Infineon offers a comprehensive portfolio of semiconductor solutions that enhance performance, efficiency, and intelligence in home appliances.

Broad Portfolio for Home Appliance Designs

Infineon's extensive portfolio addresses every critical aspect of home appliance design, from energy efficiency and control to human-machine interfaces (HMI), sensing, connectivity, and security. Here's a closer look at the offerings in each functional block:

1. Energy Efficiency

2. Control and Artificial Intelligence (AI)

3. Connectivity

4. Human-Machine Interface (HMI) and Sensing

5. Security Solutions

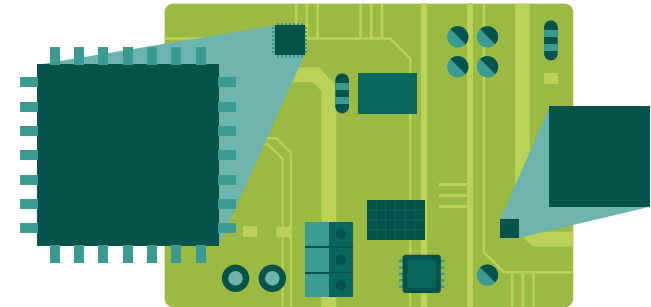

3 Infineon's semiconductor expertise in Home Appliances

1. Energy Efficiency

- Leading high-power technologies such as MOSFET, GaN, SiC, and IGBTs are at the heart of energy-efficient appliance designs. These components ensure minimal power loss and maximum operational efficiency
- Digital isolators and auxiliary power solutions enhance safety and reliability in power management
- Digital isolators and auxiliary power enable lowest standby power consumption and enhance safety and reliability in power management SMPS provide robust solutions for switching and power supply applications
- Highest efficiency wide bandgap solutions like Gallium Nitride and Silicon Carbide require less cooling and therefore can help to reduce system cost

2. Control and Artificial Intelligence (AI)

- PSOC™ Control C3 and XMC™ microcontrollers offer advanced discrete motor control, facilitating precise and efficient operation
- PSOC™ Edge with AI inference capabilities brings intelligent processing to the edge, enabling smarter and more responsive appliances

3. Connectivity

- AIROC™ solutions deliver robust IoT connectivity, with over 1 billion devices already in use. These solutions enable seamless integration and control within the smart home ecosystem
- Leading AIROC™ Wi-Fi and Bluetooth® combo solutions ensure reliable wireless communication for connected appliances
- The connected kitchen is transformed with Matter and Thread technologies, promoting interoperability and enhanced user experiences

4. Human-Machine Interface (HMI) and Sensing

- CAPSENSE™ touch interfaces provide responsive and waterproof interaction solutions, enhancing user experience even in challenging environments
- CAPSENSE™ liquid and foam level detection supports reliable and efficient fluid management
- XENSIV™ MEMS-based CO₂ sensors and industry-leading microphones ensure accurate environmental monitoring and voice recognition
- XENSIV™ radar-based presence detection offers advanced sensing capabilities for improved safety and convenience
- XENSIV™ 3D magnetic sensor and current sensing capabilities

5. Security Solutions

- OPTIGA™ security solutions ensure secure internet connections and safeguard data integrity
- Secure hardware elements provide robust protection for sensitive information transfer
- OPTIGA™ Trust M MTR product facilitates secure cloud services

By offering high reliability, superior performance, and innovative technologies across various functional blocks, Infineon empowers you to create smarter, more efficient, and highly reliable appliances that cater to the evolving demands of consumers.

As we continue through this guide, we'll explore how these technologies are applied in specific home appliance categories, showcasing their impact on enhancing state-of-the-art designs.

GaN in Home Appliances

GaN is expected to gain significant traction in the home appliance market, driven by the need for higher energy efficiency ratings, reduced energy consumption, and reduced system costs.

GaN in home appliances gains strong momentum, followed by a rapid increase over the next four years with a projected compound annual growth rate of 121 percent from 2023 to 2029 [1]. One of the driving forces behind the adoption of GaN in applications such as laundry washing machines, refrigerators, and other home appliances is the need to comply with energy regulations and differentiation via energy labels in major markets. The energy label rates appliances based on their energy consumption and is a crucial factor in consumers' purchasing decisions.

To achieve the highest ratings, manufacturers must decrease energy consumption while maintaining high performance levels. One potential solution is to increase the efficiency of the power conversion inside home appliances. GaN technology is well-positioned to play a key role in this effort. The efficiency gains offered by GaN are significant [2]. In 800 W applications, for example, GaN can enable a 2 percent efficiency gain [3], which can help manufacturers achieve the coveted A ratings. This is possible through GaN's ability to switch faster and, therefore, more efficiently, and as such, it matches the performance needs of high-efficiency motors required to decrease losses.

As the home appliance market continues to evolve, adopting GaN technology will likely play a key role in driving innovation and reducing energy consumption - a positive contribution to decarbonization. A GaN-optimized inverter design can also benefit from reduced electromagnetic interference (EMI). Unlike traditional power devices, GaN has no body diode, which reduces parasitic effects like reverse recovery charge. In addition, GaN-based inverters switch faster, allowing small high-inductance motors to operate at higher speeds.

This reduces the need for complex transmission systems in certain home appliances, thus saving costs. In addition, it allows for more compact motor drives and helps lower the audible motor noise. Finally, the efficiency benefits of a GaN-based inverter are that it has less heat to dissipate, allowing engineers to eliminate the need for heat sinks. Heat sinks, typically made of aluminum, are bulky and require manual mounting during manufacturing. When operating in high-humidity environments, heat sinks become a point of failure due to condensation, decreasing reliability. By eliminating heat sinks, manufacturers can save an estimated 3 USD per system. These cost savings, combined with the improved performance, efficiency and reliability of GaN-based inverters at higher power density, make GaN-based solutions an attractive alternative for modern home appliances' designs.

For more GaN-related trends, download our GaN Predictions e-book here.







[1] Yole Intelligence: Power SiC/GaN Compound Semiconductor Market Monitor, Q4 2024:

<https://www.yolegroup.com/product/quarterly-monitor/power-sicgan-compound-semiconductor-market-monitor/>

[2] University of Sheffield: <https://www.sheffield.ac.uk/gancentre/publications/highlights>

[3] Infineon calculation

4 Product recommendations per application category

-  4.1 Air purifier
-  4.2 Ceiling fan
-  4.3 Coffee maker and grinder
-  4.4 Cordless vacuum cleaners
-  4.5 Induction cooking
-  4.6 Laundry machines & tumble dryers
-  4.7 Refrigerators & freezers



4.1 Air purifier

Smart and efficient air quality improvement

Breathing in fresh, clean air has never been more vital for our health — and the next generation of air purifiers lets you take air quality to a whole new level. Today, the best smart air purifiers boast intelligent features like voice control apps that allow you to monitor particle levels, and schedule cleanings days in advance.

It takes time to filter all the air in a room, meaning these units usually operate continuously, making low energy consumption essential. Also since they operate in living spaces, low noise and vibration are also significant factors to consider. Sensors measure air quality, detect presence, and recognize gestures. Connectivity to integrate the air purifier into a smart home remote control can be achieved through Wi-Fi. At the same time, the user can interact with the device through a modern Human-Machine Interface (HMI) or voice control.

Highly integrated Infineon components for air purifiers provide high efficiency, low noise, and low energy consumption in motor drivers. A reliable wireless connectivity solution combined with high-accuracy sensing provides environmental intelligence and seamless connection with smart homes.

Features and benefits

Key features

- Wide portfolio of highly integrated solutions
- Robust IPM motor control solutions
- Broad portfolio of innovative sensor solutions
- Reliable connectivity with Wi-Fi / BLE
- High reliable and market-proven Infineon products

Key benefits

- Reduced BOM cost and development effort, increased space saving
- Optimized system performance and reliability compared to discrete
- Measure air quality, turn off when not needed, save energy
- Smart home appliance
- Extend system lifetime

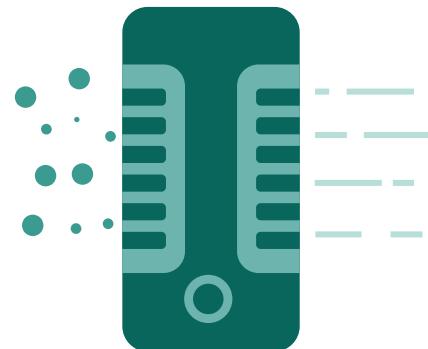



4.1 Air purifier

Smart and efficient air quality improvement

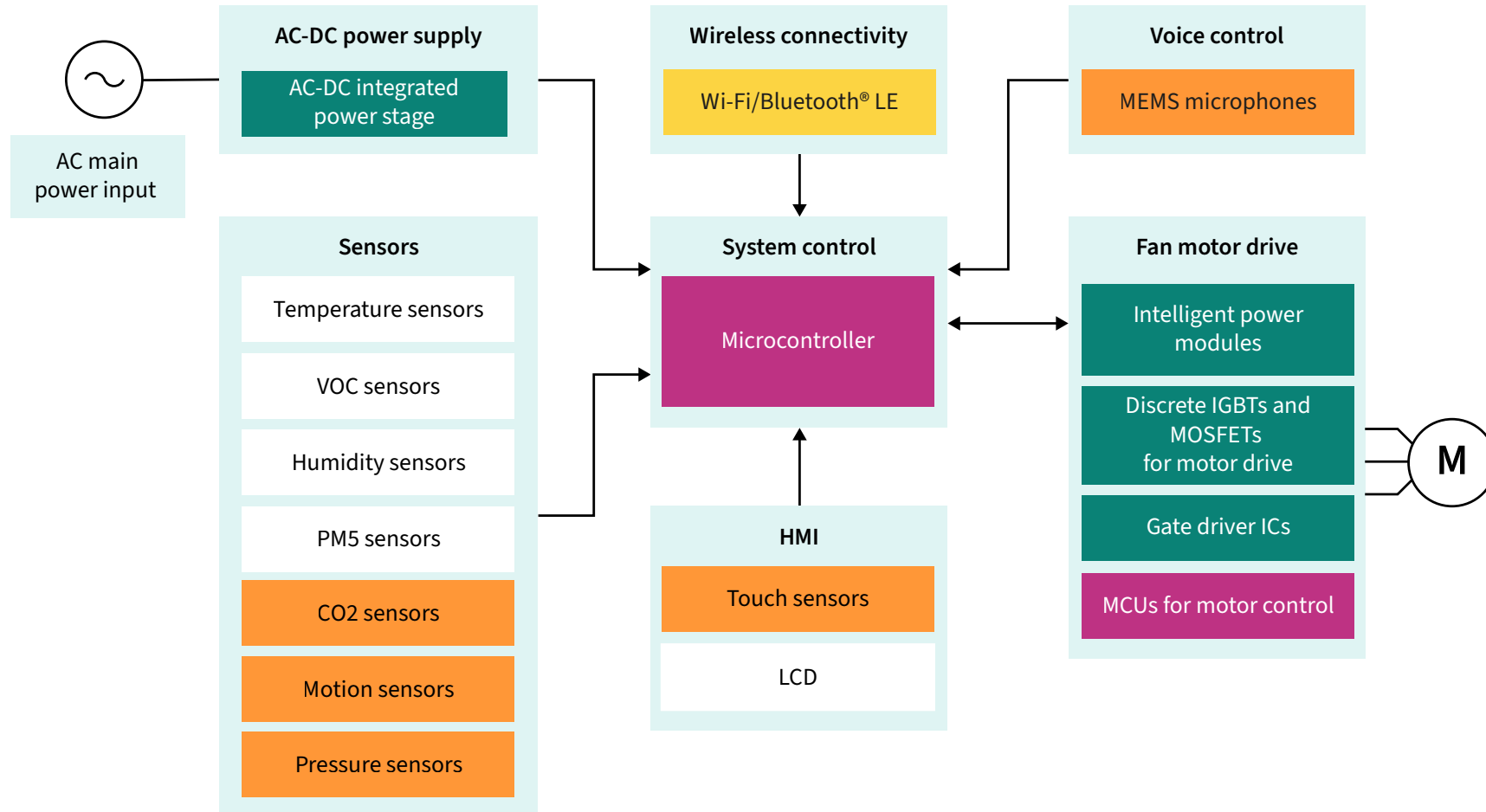

Click here to learn more:

www.infineon.com/air-purifier





4.1 Air purifier

Smart and efficient air quality improvement

Functional block	Product	Product family	Part number	Benefits
AC-DC power supply	AC-DC integrated power stage	CoolSET™ AC-DC integrated power stages	ICE5AR4770BZS	<ul style="list-style-type: none">- Reduce BOM count and cost with integrated error amplifier- Increase mid and light load efficiency with digital frequency reduction
Sensing	CO ₂ sensor	XENSIV™ Environmental sensor	PASCO2V01BUMA1	<ul style="list-style-type: none">- Superior accuracy, providing a direct readout of the real CO₂ level, not simply a correlation- Size and cost advantages
	Motion sensing	XENSIV™ radar sensor	BGT60TR13C	<ul style="list-style-type: none">- Accurate presence detection and vibration detection, tracking sub-millimeter motion at high speed and accuracy, both stand-alone chip as well as system solution available
	Pressure sensor	XENSIV™ pressure sensors for IoT	DPS368	<ul style="list-style-type: none">- Fast, ultra-low noise read-out allows for precise measurement of air flow- Ideal for harsh environments with water, dust, or humidity
Wireless connectivity	Wi-Fi + Bluetooth® Combos	AIROC™ Wi-Fi + Bluetooth® Combos	CYW43439	<ul style="list-style-type: none">- Best-in-class interoperability to the widest deployed wireless IP- Whole Home Range with high throughput for multi-channel audio and RSDB
Central control	Microcontroller	PSOC™ 6 microcontrollers with Arm® Cortex®-M4 / M0+	CY8C6116BZI-F54 , CY8C6145LQI-S3F42	<ul style="list-style-type: none">- Highly integrated HMI solution with capacitive touch sensing and TFT display- Providing the total solution of IoT connectivity and security (cloud service, Mesh gateway)
Voice control	MEMS microphone	XENSIV™ MEMS microphones for consumer	Multiple, depends on the design. here	<ul style="list-style-type: none">- High-performance microphone with low self-noise (high SNR) and low distortions- Various of packaging options and sensitivity as well as official partner software enabling solutions for voice commands
HMI	Capacitive touch sensing controller	CAPSENSE™ capacitive touch sensing controllers	here	<ul style="list-style-type: none">- State-of-the-art noise immunity (SNR > 100:1) and water rejection- Advanced inductive touch sensors make sleek, futuristic user interfaces possible
Motor control and drive (fan)	Intelligent power module	CIPOST™ Nano MOSFET IPMs	IRSM836-045MA , IRSM836-035MB	<ul style="list-style-type: none">- Optimal solution for highly integrated fan motor drives- Made for space-constrained applications with ultra compact footprint



4.1 Air purifier

Smart and efficient air quality improvement

Functional block	Product	Product family	Part number	Benefits
Motor control and drive (fan)	Intelligent power module	iMOTION™ highly integrated motor control IPMs	IMM101T-046M	<ul style="list-style-type: none">- Lowest BOM cost with reduced BOM count and PCB size, sensorless FOC algorithm, and no need for additional PFC controller- Smallest PCB footprint for 3-phase inverter with PQFN 12x12 mm, and no need for heatsink up to 80W
		iMOTION™ highly integrated motor controllers (IMC)	IMC101T-T038	<ul style="list-style-type: none">- Fastest time-to-market with no programming required and easy motor parametrization and tuning- No external OPAMP or comparators required and single shunt sensorless FOC operation- Full protection for power stage and motor; full flexibility on gate driver and power stage
	Discrete IGBT	600 V reverse conducting drives 2 RC-D2	IKN03N60RC2 , IKN04N60RC2	<ul style="list-style-type: none">- Low switching losses and competitive price- Improved controllability; humidity ruggedness- Easy to design in products drop in SMD replacement in DPAK and SOT-223
	MOSFET	600 V CoolMOS™ PFD7 superjunction MOSFETs	IPN60R1K5PFD7S , IPN60R1K0PFD7S	<ul style="list-style-type: none">- Increased efficiency and improved thermal behavior compared to CoolMOS™ CE technology for low power drives applications- BOM cost reduction and easy manufacturing; robustness and reliability
	Gate driver IC	EiceDRIVER™ 600 V full-bridge three-phase gate driver ICs	6EDL04I06PT	<ul style="list-style-type: none">- Excellent ruggedness and noise immunity- Integrated bootstrap diode, overcurrent protection, enable and fault reporting
		EiceDRIVER™ 650 V Infineon SOI half-bridge gate driver ICs	2ED2304S06F	<ul style="list-style-type: none">- Integrated Bootstrap Diode for reduced BOM cost- 50% lower level shift losses leads lower temperature operation and higher reliability- Flexible, small PCB footprint
	Microcontroller	32-bit XMC1000 industrial microcontrollers with Arm® Cortex®-M0	XMC1301-T038F0032 AB	<ul style="list-style-type: none">- Easy 3-phase inverter implementation with a single CCU8 PWM unit, offering shadow register transfer, external input for fault control, binary and floating pre-scaler, 16-bit to 64-bit width- 12-bit ADC with on-chip adjustable gain of x1, x3, x6 or x12



4.2 Ceiling fans

Energy-efficient and cost-effective solutions with high integration for system size reduction

Ceiling fan manufacturers face more stringent regulations regarding the application's form factor and are under constant pressure to reduce cost. Infineon is here to help with a compact, energy-efficient, cost-effective motor drive solution. We propose a competitive solution with an extensive portfolio, high integration for system size reduction, and low cost.

Therefore, Infineon is your ideal partner for all ceiling fan designs. In our portfolio, you will find a wide range of solutions for inverterized fan motor control – whether your priority is achieving the highest level of integration using our IPMs or showcasing ultimate flexibility with the right price-performance ratio using our discrete IGBTs or MOSFETs. No matter your target, our power semiconductors, drivers, IPMs, MCUs, sensors, connectivity combos, security solutions, and iMOTION™ motor controllers are designed to work together seamlessly. This means you can effortlessly realize a smoother-running, quieter, more connected system with low energy consumption and a small form factor, all the while getting to market even faster.

Features and benefits

Key features

- Reference design for ready-to-copy PCB
- Turnkey PFC and motor control with MCE
- Integrated infrared remote control
- Suitable for single-sided PCB assembly process
- Compatible with low- and high-voltage motors
- MCU design option for higher flexibility
- IEC61000-4-5 4 kVs surge compliant and EN55032 class B EMI compliant

Key benefits

- Compact and cost-effective system solution
- Eliminate the need for motor control software development
- Easy evaluation and system verification
- Reduce design-in effort and speed up time-to-market
- Achieve maximum system cost-performance
- Higher system reliability
- One-stop-shop for simplified development to ensure fast time-to-market

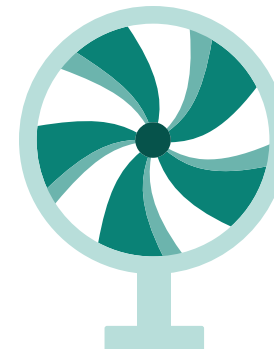



4.2 Ceiling fans

Energy-efficient and cost-effective solutions with high integration for system size reduction

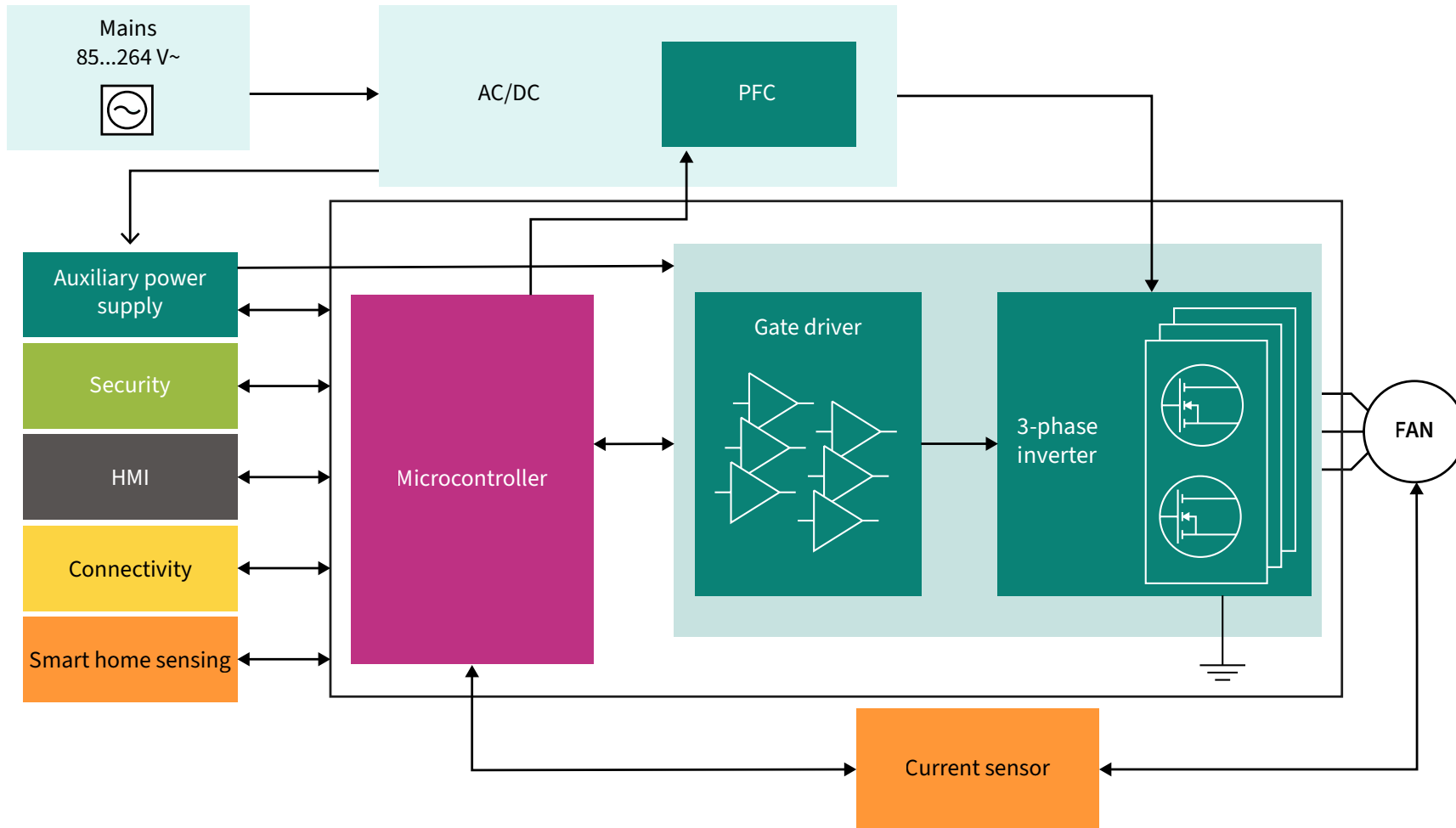

Click here to learn more:
www.infineon.com/ceiling-fan



4.2 Ceiling fans

Energy-efficient and cost-effective solutions with high integration for system size reduction

Functional block	Product category	Product family	Part number	Benefits
AC-DC power supply	PFC	AC-DC LED Driver	ICL8810	<ul style="list-style-type: none"> - Low BOM for 2-stage topologies; cost-effective with optimal efficiency - DCM for frequency foldback; QR operation for high efficiency
Auxiliary Power	Integrated power stage	CoolSET™ Fixed Frequency Controller	ICE5GR4780AG	<ul style="list-style-type: none"> - Reduce BOM count and cost with integrated line input over voltage protection and error amplifier - Increase mid and light load efficiency with digital frequency reduction
	PWM-PFC Controller	CoolSET™ Quasi Resonant Controller	here	<ul style="list-style-type: none"> - 5th generation combines the industry's benchmark for thermal performance with the latest innovation in quasi-resonant technology for unparalleled performance and efficiency
Motor control and drive	Intelligent power module	CIPOS™ Nano IPMs	here	<ul style="list-style-type: none"> - Innovative Power QFN package, utilizing PCB copper traces to dissipate heat from the module - Offering up to a 60 percent smaller footprint than existing three-phase motor control power IPMs
	Discrete IGBT	600 V Reverse Conducting Drive 2	IKD04N60RC2 , IKD06N60RC2 , IKN03N60RC2 , IKA08N65H5	<ul style="list-style-type: none"> - Adequate performance at competitive price - Good enough di/dt controllability in order to reduce electromagnetic noise - Improved humidity robustness (HV-H3TRB test passed) - Wide portfolio with current classes range from 4A-15A and 1A-6A in SOT-223
	MOSFET	CoolMOS™ P7 superjunction MOSFET	IPA80R1K4P7	<ul style="list-style-type: none"> - 0.1% to 0.6% efficiency gain and 2°C to 8°C lower MOSFET temperature as compared to CoolMOS™ C3 - Enabling higher power density designs, BOM savings and lower assembly cost



4.2 Ceiling fans

Energy-efficient and cost-effective solutions with high integration for system size reduction

Functional block	Product category	Product family	Part number	Benefits
Motor control and drive	Gate driver	MOTIX™ 160 V SOI based gate driver	6ED2742S01Q	<ul style="list-style-type: none"> - High power density, durability and reliability with smaller footprints - Excellent thermal management, scalability and simplicity of usage
		EiceDRIVER™	6EDL04I06PT	- 500 – 700 V level shift gaze driver, space saving package and improved energy efficiency
			2EDL23I06PJ	- 600 V half-bridge gate driver IC
			2ED2106S06F	<ul style="list-style-type: none"> - 650 V, 0.7 A high-side and low-side gate driver - Integrated bootstrap diode; reduced BOM cost & 50% lower level-shift losses - Excellent ruggedness and noise immunity against negative transient voltages on VS pin
			2ED2184S06F	<ul style="list-style-type: none"> - 650 V, 2.5 A high-current half-bridge gate driver - High current gate driver - suitable for high current power device, and high frequency application - Integrated bootstrap diode (BSD)
Microcontroller		32-bit XMC™ Industrial Microcontroller Arm® Cortex®-M0	XMC1302-T038X0032 AB	- Significant CPU performance, integrated peripheral functionality and rapid development environment enabling short time-to market, without compromising cost efficiency
		iMotion™ series	IMC102T-F064 , IMD111T-6F040	<ul style="list-style-type: none"> - Feat. all the control and analog interface functions required for sensorless field oriented control (FOC) of PM - Motors using DC link or leg shunt current measurements - Patented and field proven motion control engine (MCE) eliminating software coding – available tool iMOTION™ Solution Designer (iSD) for faster development
Sensor system		Current sensors	here	- High-precision coreless open-loop current sensors are less bulky and cost less compared to core-based current sensors



4.2 Ceiling fans

Energy-efficient and cost-effective solutions with high integration for system size reduction

Functional block	Product category	Product family	Part number	Benefits
Security	Authentication/security	OPTIGA™ Trust	OPTIGA TRUST M SLS32AIA	<ul style="list-style-type: none"> - Easiest way to add security, works with any MCU/MPU - Robust, future-proof security solution
HMI	InfraRED interface	32-bit PSOC™ 4 Arm® Cortex®-M0 MCU	here	<ul style="list-style-type: none"> - The most flexible and scalable low-power mixed-signal architecture
Connectivity	WiFi + Bluetooth®	AIROC™ Wi-Fi + Bluetooth® Combos	here	<ul style="list-style-type: none"> - A single-chip solution to enable small-form-factor IoT designs
Sensing	MEMS microphones	XENSIV™ MEMS microphones	here	<ul style="list-style-type: none"> - Capturing audio signals with unprecedented precision and quality
	Radar sensor	XENSIV™ 60 GHz Radar sensor	BGT60LTR11AIP , BGT60UTR11AIP , BGT60TR13C	<ul style="list-style-type: none"> - First completely autonomous radar sensor for motion sensing - Energy, lifetime saving, and small form factor with integrated antennas - Enabling presence detection, segmentations and other unique features
	CO ₂ sensor	XENSIV™ Environmental sensor	PASCo2V01	<ul style="list-style-type: none"> - High-quality data and compliance with most stringent regulations for indoor air quality (e.g., title 24 in California) - Cost-effective high-volume assembly and easy system integration - High-speed pick and place for fast and automatic assembly - No need of post calibration



4.2 Ceiling fans

Energy-efficient and cost-effective solutions with high integration for system size reduction

REF_36W_SLFOC_XMC13_CF reference design

The reference design is 36 W low-voltage ceiling fan solution.

Powered by integrated controller at AC-DC PFC flyback stage for constant voltage output, the REF_36W_SLFOC_XMC13_CF is a turn-key plug-in low voltage solution with UI configuration, enabling a smoother and faster implementation process.

The reference design is powered by ICL8810 integrated controller (IC) at the AC-DC PFC flyback stage for constant voltage output along with IPA80R750P7 MOSFET. XMC1302 microcontroller from the XMC series is used for brushless direct current (BLDC) sensorless field-oriented control (FOC) motor drive. It also includes the 160 V 6ED2742S01Q 6-channel gate driver and IRLML0040TRPBF (SOT23) as motor inverter MOSFET; which provide a cost-effective, high-performance and flexible system.

Summary of Features

- 230 VAC nominal operating input
- Efficiency at least 85%. Full Load
- Standby power <0.85 W at input 90~300 VAC
- Flyback input/output OVP

Benefits

- Single-shunt sensorless FOC
- Stall Detection
- Catch-free running
- IR/RF remote speed control
- GUI interface Tuning
- Motor driver HW/SW OCP, DC-link OVP/UVP



Click here to learn more:

[REF_36W_SLFOC_XMC13_CF](#)

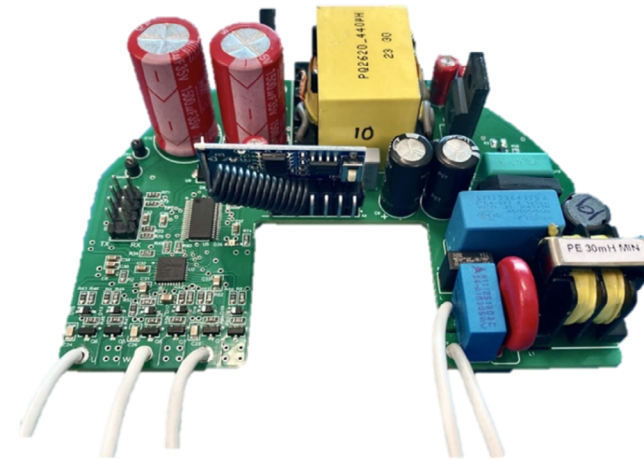



4.3 Coffee maker and grinder

Inverter-driven, highly efficient and intuitive coffee machines

Modern coffee machines are beautiful and smart – minimalistic design and intelligent functionalities are must have the electrical engineers are on the look out for the latest innovations in human-machine interface (HMI) functions, interoperability and connectivity. Infineon enables button-less designs with our capacitive touch sensors, reliable liquid level sensing with CAPSENSE™.

Today's consumers expect fast and responding machine inputs, with touch buttons or displays. Modern HMI offer a cost-effective integration of graphical user interface presenting machine information, smoothly animated instructions – guide your customer to the best coffee directly on the machine. Infineon's PSOC™ Edge product family is at the forefront of this movement, providing robust solutions for AI-market entry. Infineon provides an end-to-end software solutions for easy training and deployment. Coupled with the right hardware, these solutions ensure seamless integration of edge AI models into your coffee machines and grinders, enhancing both functionality and user experience.

Build a stronger customer relationship by seamlessly integrating the coffee machine in your smart appliance ecosystem using Matter or improve your device with AIROC™ wireless connectivity solutions. Manufactures can push new functionalities with over-the-air updates.

Features and benefits

Key features

- Cutting-edge touch-sensing technologies CAPSENSE™
- PSOC™ Edge and PSOC™ 6 for modern graphical user interface on display
- Robust and reliable connectivity AIROC™ solutions for Wi-Fi, BL/BLE, Matter
- Auxiliary power supply solutions for low standby power
- Power portfolio for motor control pump for water pressure, actuators
- XENSIV™ hall sensors to understand position in automatic coffee makers

Key benefits

- Fast and responsive, reliable, easy to clean and liquid level sensing functionality
- Higher system reliability and best performance with proven flexibility
- Ease of use and full compatibility within smart home domain
- Delivering best-in-class price/performance ratio with excellent ease-of-use
- Energy-efficient and reliable designs with highest power density
- Condition monitoring and predictive maintenance enablement





4.3 Coffee maker and grinder

Inverter-driven, highly efficient and intuitive coffee machines

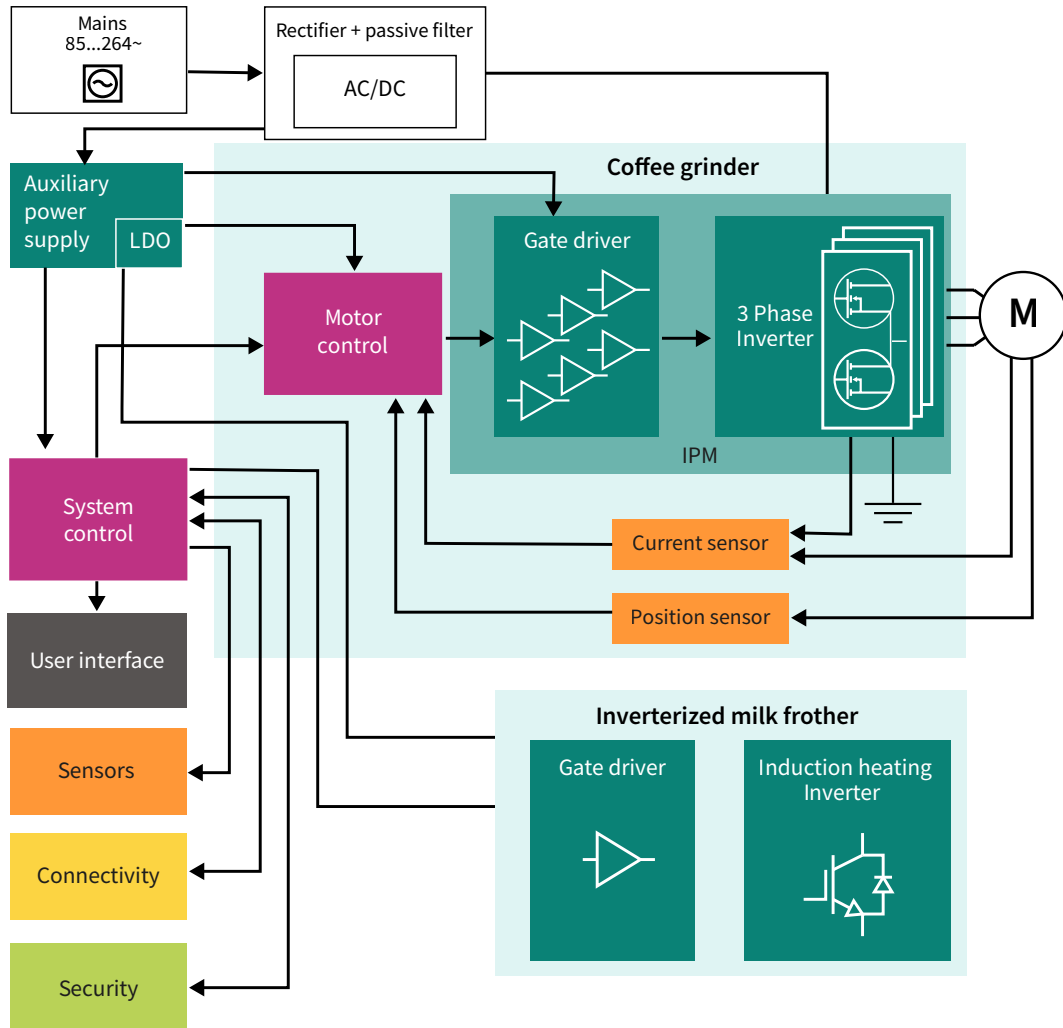

Click here to learn more:

www.infineon.com/coffee-machine





4.3 Coffee maker and grinder

Inverter-driven, highly efficient and intuitive coffee machines

Functional Block	Product category	Product Family	Part number	Specification & benefits
Liquid level sensing & water hardness		PSOC™ 4000T microcontroller	4000T (MSCv3-LP sensing)	<ul style="list-style-type: none"> - PSOC4™ MCU based solutions for accurate water level measurement and water hardness continuous analysis powered by new CAPSENSE™ and AI/ML algorithms 32-bit MCU subsystem - Inductive & Liquid level sensing Hover touch
Main MCU	Microcontroller	32-bit PSOC™ Arm® Cortex® Microcontroller	PSOC™ -series	<ul style="list-style-type: none"> - PSOC™ software delivers easy-to-use tools to get your ideas to market quickly and easily - ModusToolbox™ comprises Infineon's latest development tools including an IDE
User interface	Control & HMI	32-bit PSOC™ Arm® Cortex® Microcontroller	PSOC 4000T , PSOC Edge E83	<ul style="list-style-type: none"> - PSOC™ 4000T for CAPSENSE and touch on metal inductive sensing - PSOC™ Edge E83 for display control and advanced modern user interface
	Protection	Solid state isolators	ISSI20R02H	<ul style="list-style-type: none"> - Coreless-transformer advanced solid-state isolator, Galvanic Isolation up to 5.7 kV rms
	Magnetic sensor for knob control	XENSIV™ 3D magnetic sensor	TLI493D-W2BW A1	<ul style="list-style-type: none"> - Extremely small form factor with low power consumption due to wake-up mode - Component reduction due to 3D magnetic measurement principle
Connectivity	Wi-Fi + Bluetooth® Combos	AIROC™ Wi-Fi + Bluetooth® Combos	selected products	<ul style="list-style-type: none"> - Wi-Fi 4, 5, 6/6E and Bluetooth® 5.x combo family expands our Wi-Fi leadership into 802.11ax including tri-band (2.4GHz, 5GHz, 6GHz) capability - Ultra-low power single-chip, combo device, best-in-class connectivity, range and robustness
Security	Embedded security solutions	OPTIGA™ security solutions	OPTIGA™ Trust M	<ul style="list-style-type: none"> - CC EAL 6+ (high) certified tamper-resistant hardware used with any MCU/MPU or application processor



4.3 Coffee maker and grinder

Inverter-driven, highly efficient and intuitive coffee machines

Functional Block	Product category	Product Family	Part number	Specification & benefits
Auxiliary Power Supply	AC-DC Power Conversion	PWM-FF (fixed frequency) Flyback ICs	ICE5ASAG	- 5th generation fixed frequency flyback PWM controller, increase mid and light load efficiency with digital frequency reduction
		PWM-QR (quasi resonant) Flyback ICs	ICE5QSBG	- Inherently low gate charge (Q G) of the CoolMOS™ 7th generation platform - High efficiency
		CoolSET™ Quasi Resonant	ICE5QR4780BG	- 5th generation quasi-resonant CoolSET™ with integrated 800 V CoolMOS™ SJ MOSFET in SMD package - Auto-restart recovery scheme to minimize interruption to system operation
		CoolSET™ Fixed Frequency ICE5 Plus	ICE3RBR1765JG	- Wide power range with low standby power levels - Highest power delivery without heatsink in the market with standard PG-DIP7 up to 41 W - Support non-isolated buck output current up to 700 mA
Motor control	Motor control	iMOTION™ driver integrating motor controller	PSOC™ Control C3M	- Specially designed for motor control, integrated programmable analog sub-systems such as the 12-bit, 12-Msps high-performance ADC, and CORDIC Accelerator
		32-bit XMC1000 Industrial Microcontroller Arm® Cortex®-M0	XMC1300	- Focus on low-cost embedded control applications, 8-200KB Flash, 16KB RAM, supply voltage range: 1.8 to 5.5 V, in PG-VQFN/TSSOP, temperature range: -40 - 105°C



4.3 Coffee maker and grinder

Inverter-driven, highly efficient and intuitive coffee machines

Functional Block	Product category	Product Family	Part number	Specification & benefits
Gate driver	Gate driver ICs for grinder	EiceDRIVER™ gate driver	6EDL04I06PT	- 600 V full-bridge three-phase gate driver IC for MOS-transistors or IGBTs in PG-DSO-28 with LS-SOI technology
			IRS2007S	- 200 V half-bridge gate driver IC with typical 0.29 A source and 0.6 A sink currents in PG-SOIC-8 for MOSFETs
			2ED2304S06F	- 650 V Infineon SOI half-bridge gate driver IC with integrated Bootstrap Diode for IGBTs and MOSFETs with 0.36 A source and 0.7 A sink currents in PG-DSO-8
	Gate driver ICs for inverterized milk frother	EiceDRIVER™ gate driver	1ED44176N01F	- 25 V single-channel low-side non-inverting gate driver for MOSFET and IGBT with typical 0.8 A source and 1.75 A sink currents in a small 8-lead PG-DSO8
			1ED44173N01B , 1ED44175N01B	- 25 V single-channel low-side non-inverting gate driver for MOSFET with typical 2.6 A source and sink currents in a tiny 6-lead PG-SOT23
	Gate driver for induction heating	EiceDRIVER™ gate driver	1ED44171N01B	- 25 V single-channel low-side, integrated fault reporting, robust against VCC spikes in harsh circuit applications
Induction heating inverter	IGBTs	IGBT Discrete with anti-parallel diode	IHW20N140R5L	- 1400 V, 20 A IGBT discrete with reverse conducting diode in TO-247 3pin package
			IHW25N140R5L	- 1400 V, 25 A IGBT discrete with reverse conducting diode in TO-247 3pin package
Motor drive interter (Discretes)	IGBTs	RC drives 2	IKD10N60RC2	- 600 V, 10 A IGBT Discrete with Reverse Conducting Drive 2-diode in PG-TO-252
			IKD06N60RC2	- 600 V, 6 A IGBT Discrete with Reverse Conducting Drive 2-diode in PG-TO-252
		CoolMOS™ 7	IPD60R600PFD7S	- 600 V CoolMOS™ PFD7 superjunction MOSFET in PG-TO-252 DPAK, minimized switching losses, ~500 mOhms
Motor drive inverter (IPM)		CIPOS™ Intelligent Power Modules (IPM)	CIPOS™ Series	- The modules improve system performance and energy efficiency by delivering increased power density, enhanced system ruggedness and reliability in any consumer application
		CoolGaN™ transistors, half bridge + gate driver and flyback diode	IGI60L5050B1M	



4.3 Coffee maker and grinder

Inverter-driven, highly efficient and intuitive coffee machines

Functional Block	Product category	Product Family	Part number	Specification & benefits
Sensing	Current sensor	XENSIV™ sensors	TLI5570-AE35E1-E0001	<ul style="list-style-type: none">- Robust, highly linear monolithic tunnel magnetoresistance technology with a bandwidth of a more than >1.1MHz
	Position sensor	XENSIV™ 3D magnetic sensor	TLE4913	<ul style="list-style-type: none">- Unchopped omnipolar hall switch for low power applications with high reliability for position sensing- Battery operating voltages of 2.4V to 5.5V- Precise magnetic switching points and high temperature stability
			TLE4961-1M	
	Pressure sensor	XENSIV™ pressure sensors for IoT	DPS368	<ul style="list-style-type: none">- Pressure sensors for predictive maintenance or vibration monitoring- Ideal for harsh environment (water, dust & humidity)- Rel. accuracy: ± 0.06 hPa (or ± 0.5 m), precision: ± 0.002 hPa (or ± 0.02 m)
	Mircophones	XENSIV™ MEMS microphones for IoT	IM69D127 , IM72D128 , IM73A135 , MEMS Mic packaging partners	<ul style="list-style-type: none">- Ultra-low self-noise / ultra-high SNR- Sealed Dual Membrane (SDM) technology with IP57 ingress protection at microphone level- Ultra-high dynamic range and high acoustic overload point (AOP) of 128dB SPL
Radar sensor	XENSIV™ radar sensor	24GHz radar sensor	<ul style="list-style-type: none">- Next generation motion/presence sensing: Small form factor and low power consumption, highly integrated mmWave radar sensor solutions bring intuitive sensing capabilities	
		60GHz radar sensor		





4.4 Cordless vacuum cleaners

Efficient, compact, and quieter motor control solution for designing next-generation cordless vacuum cleaner

It is a common misconception that cordless vacuum cleaners are less powerful than their corded counterparts. With Infineon's solution, we help to create a battery-powered cordless vacuum that delivers as much suction power as a corded vacuum and maintains the convenience and flexibility of moving in the room.

Our products aim to revolutionize the cleaning experience with

- Efficient and compact motor control to deliver optimal cleaning performance
- Fast battery charger with USB-C charging and wireless charging to reduce charging time
- Advanced battery management system (BMS)
- Reliable HMI, wireless connectivity, and a variety of sensors

Features and benefits

Key features

- Highly reliable and market-proven Infineon products
- Comprehensive product/solution portfolio for motor drives and charging
- Complete selection for connectivity and sensors
- Overall system size and BOM reduction
- High complete design support with documentation and demo board

Key benefits

- Extend system lifetime
- Convenient selection of the right-fit products
- One-stop-shop for building intelligent home appliance
- Compact design reducing system size and cost for the highest power density
- Fast time-to-market

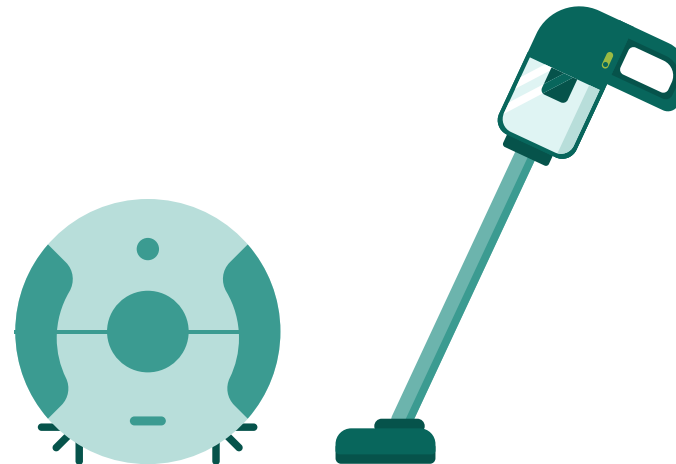



4.4 Cordless vacuum cleaners

Efficient, compact, and quieter motor control solution for designing next-generation cordless vacuum cleaner

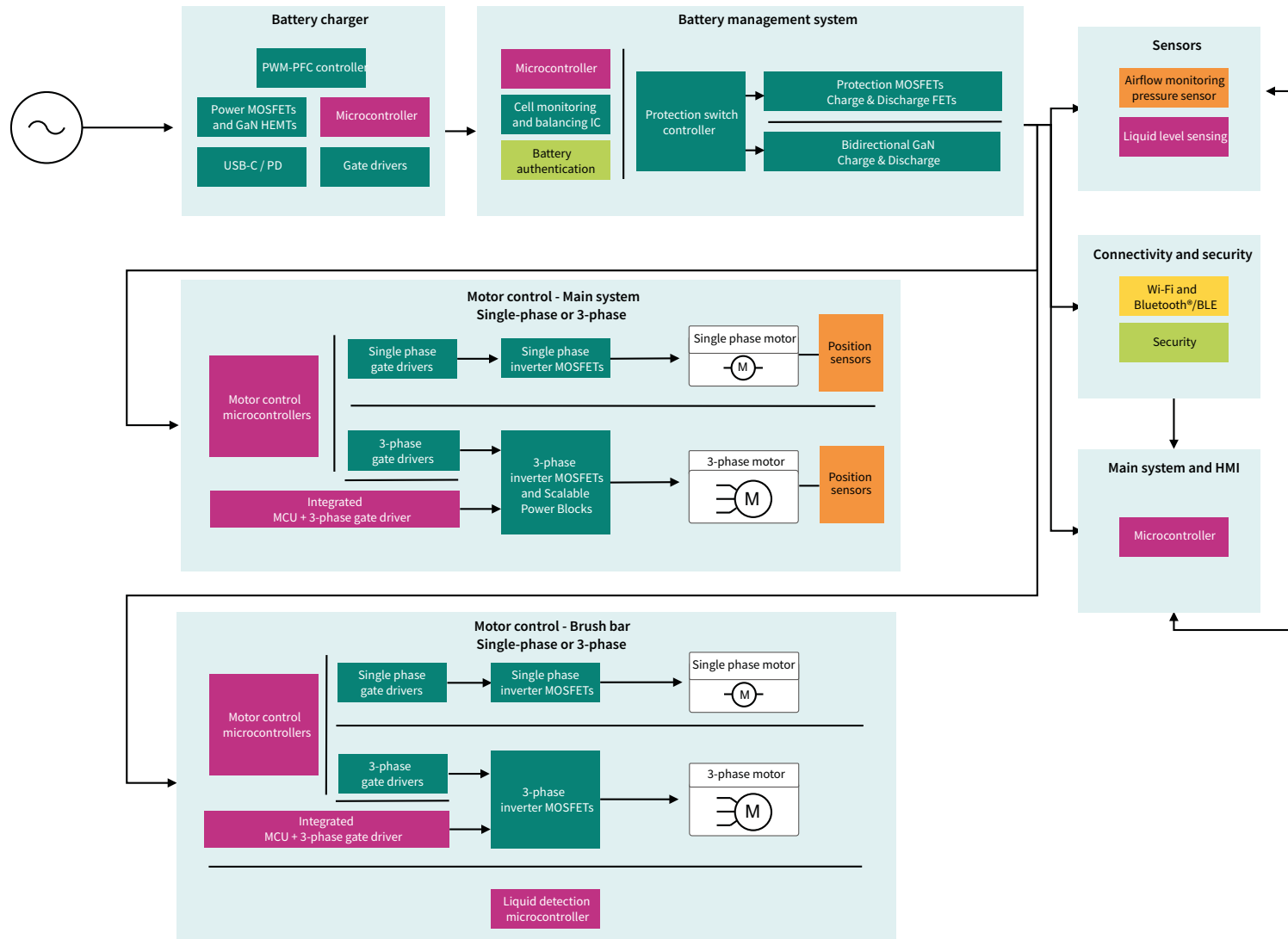

Click here to learn more: www.infineon.com/vacuumcleaner



4.4 Cordless vacuum cleaners

Efficient, compact, and quieter motor control solution for designing next-generation cordless vacuum cleaner

Functional Block	Product category	Product Family	Part number	Specification & benefits
Battery charges	PWM-PFC controller	Half-bridge and LLC controller	XDPS2201	- High efficiency of >93% and low standby power to meet international efficiency regulatory standards
			here	- The broadest range of AC-DC pulse-width modulation controllers to meet current and future industry requirements
	Power MOSFETs & GaN HEMTs	OptiMOS™ 5 Power MOSFET	BSC040N10NS5	- Industrial power MOSFET devices in 80 V and 100 V in a PG-SuperS08 5x6
		CoolMOS™ P7 Superjunction (SJ) MOSFET	IPD60R280P7S	- 600 V, excellent FOMs R DS(on)xQ G/R DS(on)xE oss enable higher efficiency
	Microcontroller	32-bit XMC1000 Industrial Microcontroller ARM® Cortex®-M0	XMC1401-Q048F0064 AA	- 64.0 KB Flash, 16KB RAM, core frequency: 48[MHZ]
	USB-PD IC	EZ-PD™ PMG1-XX	CYPM1115-48LQXI	- Integrated buck-boost controller with 5.5 V to 24 V input and 3.3 V to 21.5 V output voltage range, Rp and Rd termination resistors and the tray packing
Gate drivers	EiceDRIVER™	1EDB9275F	- Single-channel isolated gate-driver IC in 150 mil PG-DSO-8	
Battery management system	Microcontroller	32-bit PSOC™ 4 Arm® Cortex®-M0	CY8C4025AZI-S413	- Low-power, programmable mixed-signal hardware IP, bluetooth and industry leading CAPSENSE™ capacitive touch
	Cell monitoring and Balancing IC	Li-Ion battery monitoring and balancing IC	TLE9012DQU	- Cell voltage measurement, temperature measurement, cell balancing and isolated communication to main battery controller
	Battery authentication	OPTIGA™ Authenticate embedded security solution	OPTIGA AUTHENTICATE S	- 4 authentication modes, 4 lifecycle counters with independent kill structures, effortless implementation with PSOC™
	Protection MOSFET Charge & Discharge FETs	OptiMOS™ 5 Power MOSFET	BSC014N06NS , BSZ042N06NS	- Industrial power MOSFET device in 60 V in a PG-SuperS08 or PQFN 3.3x3.3
StrongIRFET™ Power MOSFET		IRLML0040	- 40 V Single N-Channel MOSFET In a PG-SOT-23, standard pinout allows for drop in replacement	



4.4 Cordless vacuum cleaners

Efficient, compact, and quieter motor control solution for designing next-generation cordless vacuum cleaner

Functional Block	Product category	Product Family	Part number	Specification & benefits
Battery management system	Protection switch controller	OptiMOS™ 5 Power MOSFET	1EDL8011	- 125 V high-side gate driver with single output in PG-DSO-8 for battery-powered applications
	Protection MOSFETs Charge & Discharge FETs	OptiMOS™ 6 40V	BSZ018N04LS6 , BSC007N04LS6	- OptiMOS™ 6 40 V power MOSFETs combining best-in-class RDS(on) with superior switching performance in PG-SuperS08 or PQFN 3.3x3.3
	Bidirection GaN Charge & Discharge	CoolGaN™ HEMT	here	- Discrete and integrated solutions delivering highest efficiency and power density for power conversion in the voltage range up to 700 V.
Motor control - Main system Single-phase or 3-phase	Microcontroller	PSOC™ Control Arm® Cortex®-M33 Main	PSC3M5FDS2AFQ1	- Newest MCU's developed specifically for motor control applications - Integrating advance real-time control peripherals for improved performance of the next motor control products
		32-bit XMC1000 Industrial Microcontroller ARM® Cortex®-M0	XMC1401-Q048F0064 AA	- 64.0 KB Flash, 16KB RAM, core frequency: 48[MHZ]
	Evaluation kit	PSOC™ Control C3M5 Motor Drive Control Card	KIT_PSC3M5_CC2	- Out of the box configuration, feat. an isolated onboard debugger for programming and debugging over a USB interface
	Integrated MCU + gate driver	MOTIX™ Battery Supplied BLDC Motor Controller Ics	IMD700A-Q064X128-AA , IMD701A-Q064X128-AA	- Fully programmable motor controller integrating XMC1404 microcontroller with 6EDL7141 3-phase gate driver IC in one package, adjustable supply voltage: 7 V, 10 V, 12 V and 15 V
	Position sensor	XENSIV™ magnetic sensor	TLE4966L	- Double Hall-effect sensor with 2.7 V to 24 V supply voltage operation
			TLI493D-W2BW A0	- Extremely small WLB-5 package (1.13 mm x 0.93 mm x 0.59 mm), low current consumption of 7 nA in power-down mode
TLI5012B E1000			- Pre-calibrated angle sensor iGMR, economic with SPI compatible interface	
	XENSIV™ current sensor	TLI4971-A120T5-U-E0000	- High precision miniature coreless magnetic current sensor for AC and DC measurements, 120 A, 3.45%, 3.1-3.5V	



4.4 Cordless vacuum cleaners

Efficient, compact, and quieter motor control solution for designing next-generation cordless vacuum cleaner

Functional Block	Product category	Product Family	Part number	Specification & benefits
Motor control - Main system Single-phase or 3-phase	Single phase gate drivers	EiceDRIVER™	2EDL05N06PF	- 600 V half-bridge gate driver IC with integrated bootstrap diode
	Single phase inverter MOSFETs	OptiMOS™ Power MOSFET	OptiMOS™ 5 25V/30V	- Industry lowest RDS(on) for 25 V and 30 V, boost system performance with best-in-class technology
			OptiMOS™ 5 40V/60V	- OptiMOS™ 5 40 V and 60 V families feature 15% lower RDS(on) and 31% lower figure of merit (RDS(on) x Qg), enabling shrunk design and boosted efficiency
			OptiMOS™ 6 40V	- benchmark solution for applications requiring lower gate drive capability
	3-phase gate drivers	MOTIX™	6ED2742S01Q	- 160 V SOI based gate driver, 100% duty cycle operation with trickle charge pump per high side
			6EDL7141	- 60 V, over 50 programmable parameters using a built-in digital SPI interface
			6EDL7151	- 5.5 V to 70 V operating range, with integrated buck converter and LDO
	3-phase inverter MOSFETs	OptiMOS™ 6 Power MOSFET	6EDL04N02PR	- 200 V three-phase gate driver IC with integrated bootstrap diode, over current protection, enable and fault reporting
			BSC010N04LS6	- 40 V power MOSFETs combining best-in-class RDS(on) with superior switching performance
		OptiMOS™ 5 Power MOSFET	ISG0613N04NM6HSC	- Dual N-channel 40 V MOSFETs in scalable power block with dual-side cooling capability
			ISC058N04NM5	- 40 V, PG-SuperSO8 with reduced switching losses leading to greater system efficiency and power density
			BSC0501NSI	- 25 V and 30 V, highest power density with S308 or Power Block package
		StrongIRFET™ Power MOSFET		IRF7480M



4.4 Cordless vacuum cleaners

Efficient, compact, and quieter motor control solution for designing next-generation cordless vacuum cleaner

Functional Block	Product category	Product Family	Part number	Specification & benefits
Motor control - Brush bar Single-phase or 3-phase	Microcontroller	32-bit XMC1000 Industrial Microcontroller ARM® Cortex®-M0	XMC1301-T038F0032 AB	- Focus on low-cost embedded control applications, 32KB Flash, 16KB RAM, supply voltage range: 1.8 to 5.5 V, in PG-TSSOP-38, temperature range: -40 - 85°C
			XMC1401-Q048F0064 AA	- Core frequency: 48[MHZ], 64KB Flash, 16KB RAM, supply voltage range: 1.8 to 5.5 V, in PG-VQFN-48, temperature range: -40 - 85°C
	Integrated MCU + gate driver	MOTIX™ Battery Supplied BLDC Motor Controller lcs	IMD700A-Q064X128-AA , IMD701A-Q064X128-AA	- Fully programmable motor controller integrating XMC1404 microcontroller with 6EDL7141 3-phase gate driver IC in one package, adjustable supply voltage: 7 V, 10 V, 12 V and 15 V
	Single phase gate drivers	EiceDRIVER™	IRS44273L	- 25 V single-channel low-side gate driver IC with 1.5 A source and 1.5 A sink currents in 5-lead PG-SOT23
	Single phase inverter MOSFETs	OptiMOS™ Power MOSFET	BSZ105N04NS G	- 40 V, perfect choice for synchronous rectification in switched mode power supplies (SMPS)
	3-phase gate drivers	EiceDRIVER™	6EDL7141	- 60 V, over 50 programmable parameters using a built-in digital SPI interface
			6EDL7151	- 5.5 V to 70 V operating range, with integrated buck converter and LDO
			6ED2742S01Q	- 160 V SOI based gate driver, 100% duty cycle operation with trickle charge pump per high side
	3-phase inverter MOSFETs	OptiMOS™ 5 25V/30V	here	- OptiMOS™, StrongIRFET™, and CoolMOS™, low, medium and high voltage power MOSFETs for low-, medium-, and high-power application
		OptiMOS™ 5 40V/60V	here	
OptiMOS™ 6 40V		here		
StrongIRFET™ 2		here		
Liquid detection microcontroller	PSOC™ 4000T Multi-Sense microcontroller	CY8C4045LQI-T412	- Capacitive sensing, Inductive sensing, liquid level sensing solution with ultra-low power and best in class signal-to-noise ratio	



4.4 Cordless vacuum cleaners

Efficient, compact, and quieter motor control solution for designing next-generation cordless vacuum cleaner

Functional Block	Product category	Product Family	Part number	Specification & benefits
Sensing	Airflow monitoring	XENSIV™ Pressure sensors	DPS368	- Fast, ultra-low noise read-out allows for precise measurement of air flow, ideal for harsh environments with water, dust, or humidity
	Liquid level sensing	PSOC™ 4000T Multi-Sense microcontroller	CY8C4045LQI-T412	- Capacitive sensing, Inductive sensing, liquid level sensing solution with ultra-low power and best in class signal-to-noise ratio
Connectivity and security	Wi-Fi and Bluetooth®/BLE	AIROC™ Wi-Fi + Bluetooth® Combos	CYW43439	- 1x1 single-band 2.4 GHz Wi-Fi 4 and Bluetooth® 5.4, a reliable entry-level solution for low-cost applications
			CYW55913	- Ultra-low power single-chip connected MCU that supports 1x1 2.4+5+6GHz Wi-Fi 6E, Bluetooth® Low Energy 5.4, and Matter
			CYW55912	- Ultra-low power single-chip connected MCU that supports 1x1 2.4+5GHz Wi-Fi 6, Bluetooth® Low Energy 5.4, and Matter
	Security	OPTIGA™ Trust Security solutions	OPTIGA TRUST M SLS32AIA	- CC EAL 6+ (high) certified tamper-resistant hardware, used with any MCU/MPU or application processor to perform various security-related tasks autonomously
			OPTIGA TRUST M MTR	- Discrete security solution combined with a Matter-certified provisioning service late-stage personalized Device Attestation Certificate (DAC) for download
			OPTIGA TRUST M EXPRESS	- Pre-provisioned Secure Element, ready to connect to Azure and AWS - Automated device and product-to-cloud provisioning
Main system and HMI	HMI Microcontroller	PSOC™ 4000T Multi-Sense microcontroller	CY8C4045LQI-T412	- Capacitive sensing, Inductive sensing, liquid level sensing solution with ultra-low power and best in class signal-to-noise ratio



4.5 Induction cooking

Enabled by Infineon's high-efficiency power switches, secured connectivity, and touch sensor technology for the best cooking experience

The huge global market for induction cooking appliances, such as induction ranges, microwave ovens, and rice cookers, is characterized by great competition and price pressure. Along with this, manufacturers must meet rising consumer expectations and produce more reliable, energy-efficient appliances that offer a wide range of functions. Benefits such as faster cooking, advanced functionalities, easy cleaning, and safety features play a crucial role.

Infineon products are well equipped to help you overcome all the challenges common to induction cooking appliances. Our solutions target the increased consumer expectations regarding modern home appliances: appliances must be energy-efficient and fully integrable, ensuring a high levels of safety and reliability. An intelligent, user-friendly, and secure user interface is essential. We support you in creating intuitive devices with an intelligent touch interface.

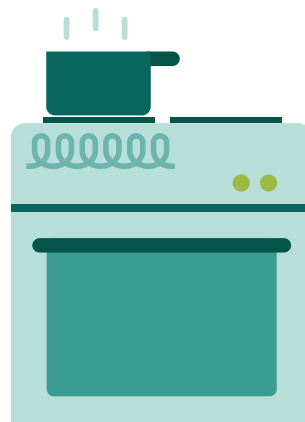

Features and benefits

Key features

- Complete system solution offerings for inverter, system control, auxiliary power, HMI, connectivity, sensor, security blocks
- Highly reliable and market-proven Infineon products
- Evaluation and reference boards
- Innovative reverse conducting IGBT technology
- Cutting-edge touch-sensing technologies
- Next generation CAPSENSE™ touch-sensing technology

Key benefits

- One-Stop-Shop: Faster time-to-market and saving system design efforts
- Extend system lifetime and product life spans
- Fast prototyping and system verification
- Higher efficiency and better reliability
- "Just work" and deliver robustness and intelligence
- Fast user feedback even with wet interface





4.5 Induction cooking

Enabled by Infineon's high-efficiency power switches, secured connectivity, and touch sensor technology for the best cooking experience

Induction heating inverter (voltage resonance)

Single-switch

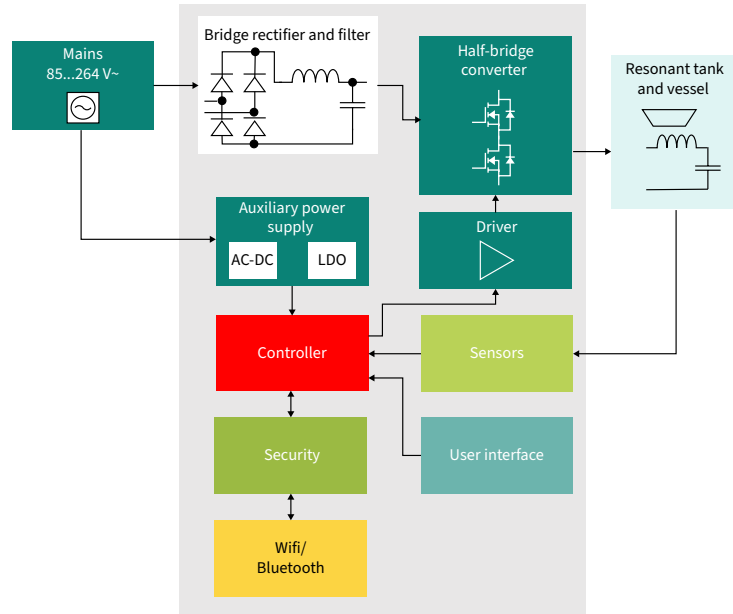

- Voltage: ≥ 1200 V used due to voltage resonance
- Typ. switching frequency range: 20 to 36 kHz (resonator)
- Power: Typically limited to 2.0 kW due to voltage on IGBT
- Typical Application is single pot induction cooktops and rice cookers (Tabletop cookers)

Key benefits: Less components \rightarrow cost optimized

Induction heating inverter (current resonance)

Half-bridge

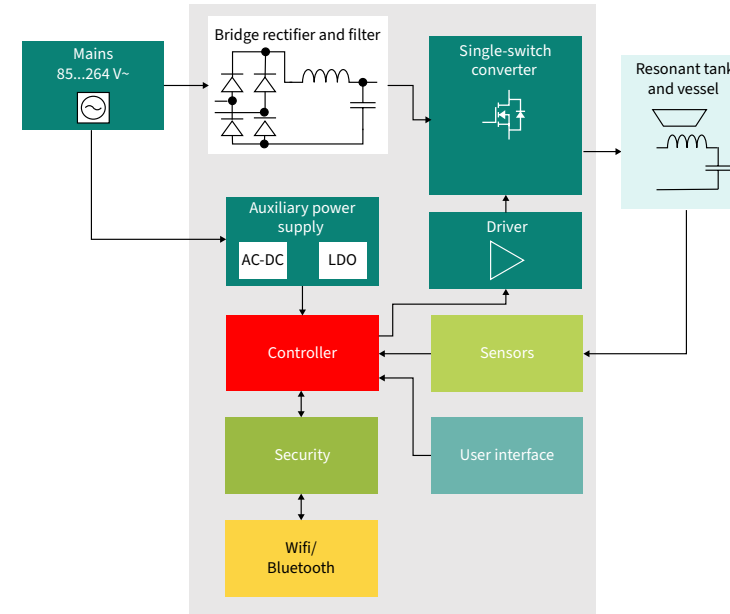

- Voltage: 650 V are used (typ. bus voltage up to 400 V due to grid fluctuation)
- Precise controlled switching frequency: 25 to 75 kHz
- Power: Single hobs up to 3,6 kW
- Typical Application in multi-hob induction cooktops

Key benefit: Lower voltages and switching losses \rightarrow energy efficiency & lower temperature



4.5 Induction cooking

Enabled by Infineon's high-efficiency power switches, secured connectivity, and touch sensor technology for the best cooking experience



Click here to learn more:

www.infineon.com/induction-cooking

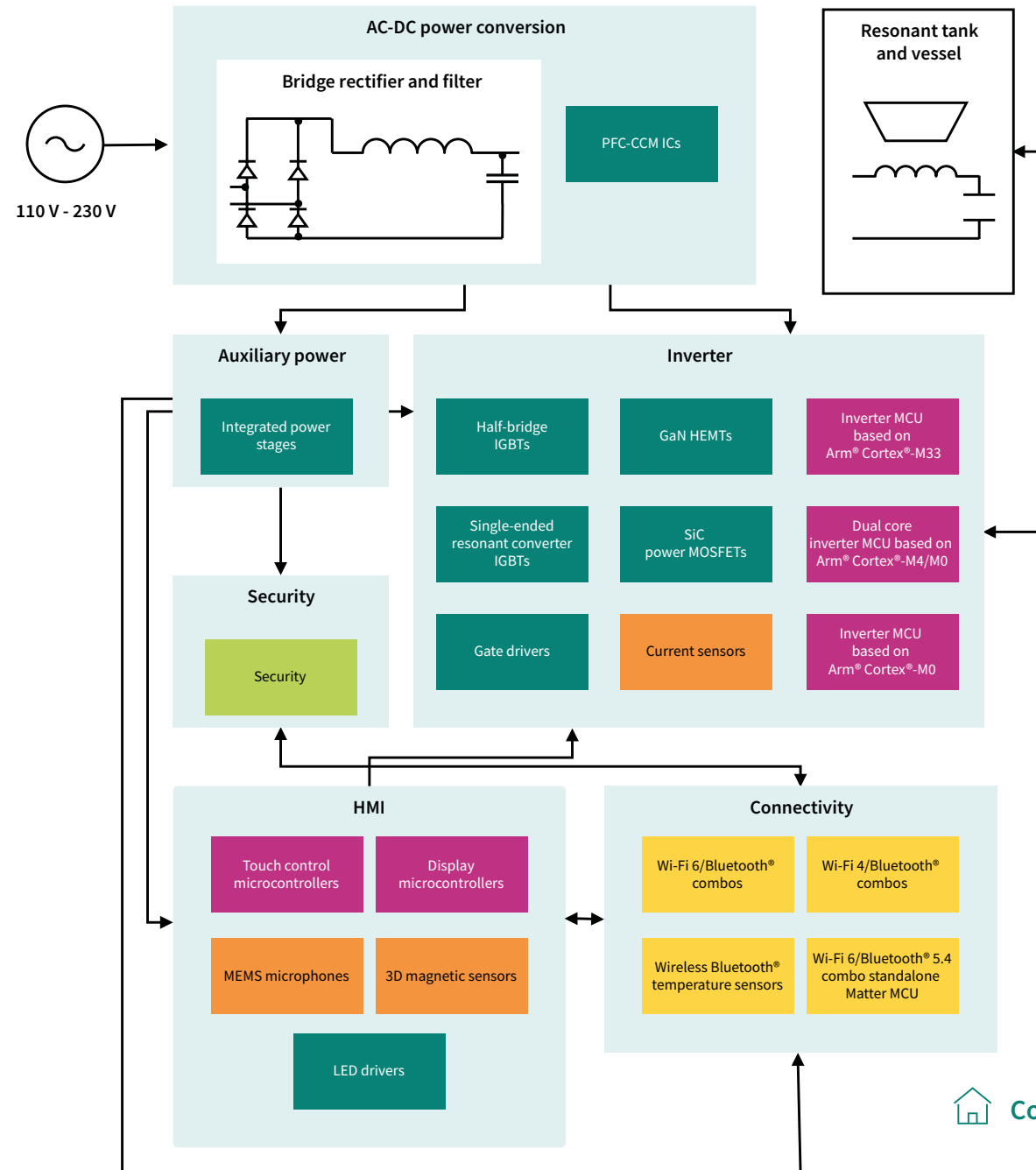



4.5 Induction cooking

Enabled by Infineon's high-efficiency power switches, secured connectivity, and touch sensor technology for the best cooking experience

Induction cooking reference design REF-SHA3K3IHWR5SYS

The REF-SHA3K3IHWR5SYS Infineon induction cooktop reference design is a ready-to-go solution that offers a modern high performance half bridge topology, next generation CAPSENSE™ user interface and PSOC™ 6 AI connectivity module.

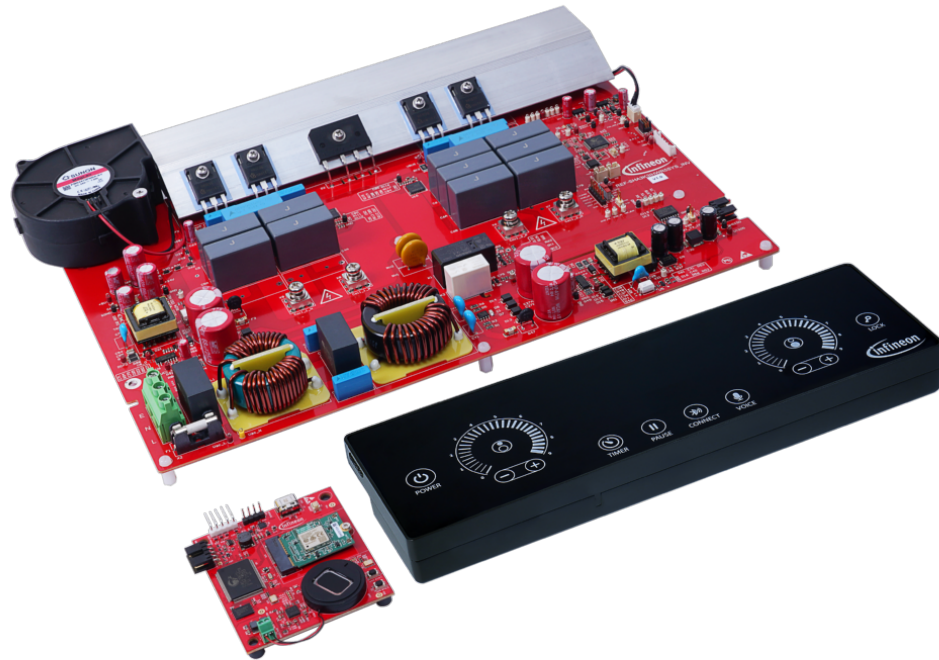

Features and benefits

Feature

- PSOC™ 4100S MAX MCU with two independent CAPSENSE™ blocks
- World leading Induction Heating IGBTs like the R6 reverse conductive IGBT
- Connectivity with Wi-Fi 5 & Bluetooth® 5.2 combo & Matter support
- Edge AI voice command solution with Infineon XENSIV™ MEMS microphones and PSOC™ 6 controller
- Class B compliant SW and HW design

Benefit

- CAPSENSE™ 5 – fast, responsive and robust against water
- Reliable power delivery at low power dissipation and EMI emissions
- Easy smart home integration with smarter and connected devices that keep up-to-date with Over-the-Air updates
- Privacy meets high sensitivity microphones and cost-efficient compute
- Faster time to market for customer with open software and hardware solution



Click here to learn more:

[REF-SHA3K3IHWR5SYS](#)



4.5 Induction cooking

Enabled by Infineon's high-efficiency power switches, secured connectivity, and touch sensor technology for the best cooking experience

Functional block	Product category	Product family	Part number	Specification & benefits
Auxiliary power	Intergrated power stages	CoolSET™ Fixed Frequency	ICE5AR4770AG	- Increase mid and light load efficiency with digital frequency reduction
		CoolSET™ Quasi Resonant	ICE5QR2280BG	- High efficiency thanks to the integrated 800 V CoolMOS™ P7 SJ MOSFET family and quasi-resonant switching scheme
		CoolSET™ AC-DC integrated power stages	here	- Specifically designed for high-performance applications, creased reliability and outstanding performance
AC-DC power conversion	AC-DC PWM-PFC Controllers	PFC-CCM Ics	ICE3PCS02G	- 8-pin wide input range (85VAC to 265VAC) controller IC for active CCM power factor correction converter for simple design procedure. Build-in protection features save system BOM cost
		PWM-PFC Controller	PFC-CCM (continuous conduction mode) ICs	- High efficiency and very low system cost, programmable switching (20 kHz-100 kHz) and external synchronzation (50 kHz~100 kHz)
Human-Machine-Interface (HMI)	Touch control microcontrollers	PSOC™ 4100 - Intelligent Analog	CY8C4124AXI-443T CY8C4025FNI-T442T	- Feat. CAPSENSE™ as the industry-leading capacitive-sensing solution for touch buttons and sliders, proximity sensing, and liquid-level sensing applications
	Display controllers	32-bit PSOC™ Edge Arm®	here	- Based on high performance Arm® Cortex®-M55, including Helium™ DSP support paired with Arm® Ethos™-U55 and Cortex-M33 paired Infineon's ultra-low power NNLite neural network accelerator
	Voice control	XENSIV™ MEMS microphones	IM69D130	- High SNR microphone with 105dB dynamic range and high output linearity up to 130dBSPL
		XENSIV™ 3D magnetic sensors	TLI493D-W2BW A0 TLI493D-A2B6	- Extremely small WLB-5 package (1.13 mm x 0.93 mm x 0.59 mm), low current consumption of 7 nA with 3D magnetic flux density sensing of ±160mT - 3D magnetic flux density sensing of ±160mT, magnetic Hall sensor for any kind of industrial or consumer applications
	LED drivers	Driver ICs	BCR431U	- Linear LED driver IC, small SOT23-6 package regulating the LED current in standalone operation without external power transistor, Flexible for 12V / 24V / 36V designs



4.5 Induction cooking

Enabled by Infineon's high-efficiency power switches, secured connectivity, and touch sensor technology for the best cooking experience

Functional block	Product category	Product family	Part number	Specification & benefits
Inverter	Half-bridge IGBTs	Reverse Conducting IGBT	IHW30N65R6 , IHW50N65R6	<ul style="list-style-type: none"> - 650 V/1200 V/1350 V/1600 V Next Generation Reverse Conducting IGBT - 650 V, 30/50 A IGBT with monolithically integrated diode in TO-247 package
	Single-ended resonant converter IGBTs	IGBT Discretets	IHW25N140R5L , IHW20N140R5L	<ul style="list-style-type: none"> - RC Soft Switching 1400 V, 20/25 A IGBT discrete with reverse conducting diode in TO-247 3pin package - Narrow power losses distribution and advanced thermal performance
	SiC power MOSFETS	CoolSiC™ MOSFET	IMZA65R026M2H	<ul style="list-style-type: none"> - CoolSiC™ MOSFET 650 V, 26 mΩ G2 in a PG-TO-247-4, maximizes the system performance per \$
	GaN HEMTs	CoolGaN™ Transistors	IGT65R035D2	<ul style="list-style-type: none"> - 650 V G5 e-mode, high ESD robustness: 2kV HBM - 1kV CDM, supporting high operating frequency - Enabling ultrahigh power density designs and BOM costs savings
	Gate drivers	EiceDRIVER™	2ED21844S06J	<ul style="list-style-type: none"> - 650 V, 2.5 A high current half-bridge gate driver IC with integrated bootstrap diode and shutdown in PG-DSO-14
			2ED2101S06F	<ul style="list-style-type: none"> - 650 V high speed, high-side and low-sidegate driver with typical 0.29 A source and 0.7 A sink currents in DSO-8 package for driving power MOSFETs and IGBTs, 50% lower level-shift losses
			1ED44175N01B	<ul style="list-style-type: none"> - 25 V single-channel low-side non-inverting gate driver IC for IGBTs with typical 2.6 A source and sink currents in a tiny 6-lead PG-SOT23
	Arm® Cortex®-M33 inverter microcontrollers	PSOC™ Control C3P	PSC3P2EDACQ1	<ul style="list-style-type: none"> - Newest MCU's developed specifically for power conversion applications, real-time analog peripherals to enable designers to improve efficiency and reliability of their new designs
	Arm® Cortex®-M0 inverter microcontrollers	32-bit PSOC™ 4 Arm® Cortex®-M0 MCU	CY8C4247AZA-M475T , CY8C4147AZI-S463	<ul style="list-style-type: none"> - Customizable analog front end through programmable analog blocks
Arm® Cortex®-M4/M0 dual core inverter microcontrollers	32-bit PSOC™ 6 Arm® Cortex®-M4 MCU	CY8C6244AZI-S4D82	<ul style="list-style-type: none"> - PSOC™ 62x4, DAC 1,12-bit @ 200 ksp/s - Built on an ultra-low-power architecture feat. Low-power design techniques, ideal for battery powered applications 	
Current sensor	XENSIV™ current sensor	TLI5570-RE35E1-E0001	<ul style="list-style-type: none"> - High precision coreless current sensor, differential analog interface, 1-5 V supply voltage, ±35mT magnetic measurement range 	



4.5 Induction cooking

Enabled by Infineon's high-efficiency power switches, secured connectivity, and touch sensor technology for the best cooking experience

Functional block	Product category	Product family	Part number	Specification & benefits
Connectivity	Wi-Fi 6/Bluetooth® combos	AIROC™ Wi-Fi 6/6E	CYW55572	- Wi-Fi 6, dual-band, 2x2 MIMO, release 1 and 2 features: OFDMA, MU-MIMO, TWT, DCM
	Wi-Fi 4/Bluetooth® combos	AIROC™ Wi-Fi 4 and Bluetooth® 5.x	CYW43439	- 1x1 single-band 2.4 GHz Wi-Fi 4 and Bluetooth® 5.4, a reliable entry-level solution for low-cost applications
	Wireless Bluetooth® temperature sensing	AIROC™ Bluetooth® LE	CYW20829	- Bluetooth® LE 5.4 MCU with Industry's best range, Dual ARM Cortex M33 dedicated for applications and CAN FD
	Wi-Fi 6/Bluetooth® 5.4 Matter MCU	AIROC™ Connected MCU	CYW55913	- Ultra-low power single-chip connected MCU that supports 1x1 2.4+5+6GHz Wi-Fi 6E, Bluetooth® Low Energy 5.4, and Matter
Security	Security solutions	OPTIGA™ embedded security solutions	OPTIGA TRUST M SLS32AIA	- CC EAL 6+ (high) certified tamper-resistant hardware, used with any MCU/MPU or application processor to perform various security-related tasks autonomously
			OPTIGA TRUST M MTR	- Discrete security solution combined with a Matter-certified provisioning service - Late-stage personalized Device Attestation Certificate (DAC) for download
			OPTIGA TRUST M EXPRESS	- Pre-provisioned Secure Element, ready to connect to Azure and AWS - Automated device and product-to-cloud provisioning
	Authentication solutions	OPTIGA™ Authenticate	OPTIGA AUTHENTICATE S	- Effortless implementation with full system integration support including embedded software, host software, full reference board based on PSOC™ 6, with demo software and full documentation



4.6 Laundry machines & tumble dryers

Elevating performance with efficient, intelligent and secure trusted solutions

Modern laundry machines and tumble dryers have seen significant advancements, enhancing their efficiency and functionality for both commercial and residential use.

Laundry machine models feature improved energy efficiency, low noise, water and detergent savings, and smart operating cycles. Infineon's comprehensive product portfolio supports various types, including fully-automatic front- and top-loading machines, semi-automatic top-loading machines, washer-dryer combinations, and twin-type washing machines. For smart dryers, on the other hand, now include wireless connectivity, voice recognition, advanced sensing, predictive maintenance, and energy-efficient heat pump systems. Infineon's solutions help design dryers that are energy-efficient, reliable, and seamlessly integrated into IoT ecosystems, providing advanced control, connectivity, and security features.

Infineon provides complete system solutions for all major components required in laundry machines and tumble dryers. This includes solutions for AC-DC power supply, advanced motor control systems, embedded microcontroller units (MCUs), connectivity, security, power management systems, and interfacing with home networking solutions. Additionally, Infineon's new machine learning (ML) and artificial intelligence (AI) edge-based MCUs and broad sensors portfolio offer cost-effective ways to improve the user experience and appeal, making them more intuitive and user-friendly.



Features and benefits

Key features

- Infineon offers a comprehensive product portfolio, featuring advanced switching technologies in Si, SiC, GaN
- Leading position & proven expertise in motor control power solutions
- Robust and reliable wireless connectivity ranges from Wi-Fi 4 to Wi-Fi 6/6E, compliant to Matter over Wi-Fi and Matter over Thread
- XENSIV™ sensor solutions cover a wide range of use cases, enabling smart features
- State-of-the-art microcontroller with mature CAPSENSE™ capacitive touch sensor
- OPTIGA™ Trust M hardware cryptographic accelerators support host MCUs with Matter onboarding

Key benefits

- One-stop shop for WBG solutions enables greater energy efficiency, higher power density, and system cost savings
- Enablement of reliable, efficient, and quieter operation, OEMs gain system-level optimization and reduced time-to-market
- Flexible usage, future-proof and full compatibility
- Contextual awareness and advanced sensing solutions for holistic condition monitoring
- Great UX, robust and effortless interactions
- Enhanced, robust security for higher cryptographic operations



4.6 Laundry machines & tumble dryers

Elevating performance with efficient, intelligent and secure trusted solutions

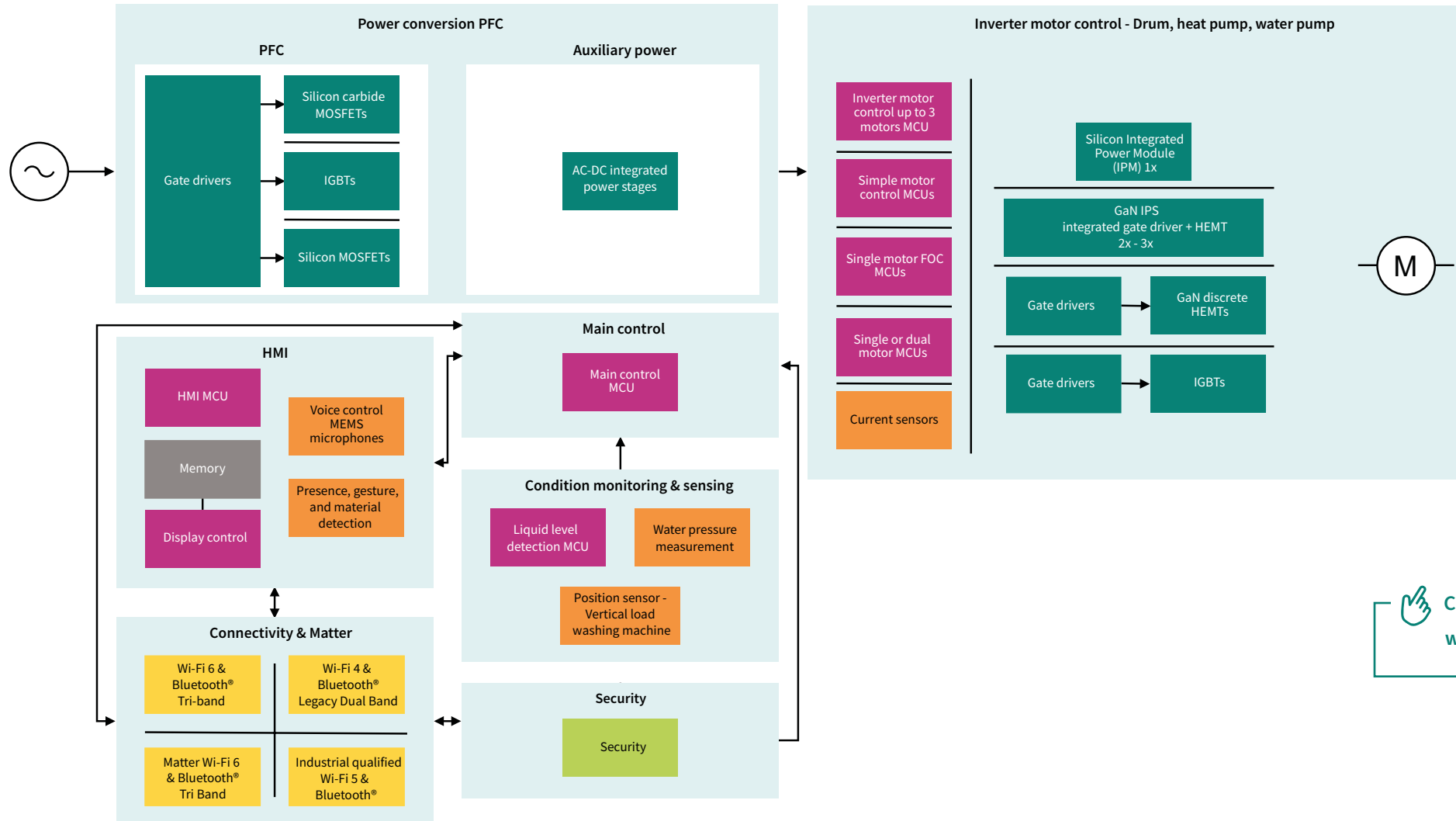

 [Click here to learn more: www.infineon.com/washing-machine](http://www.infineon.com/washing-machine)



4.6 Laundry machines & tumble dryers

Elevating performance with efficient, intelligent and secure trusted solutions

Functional block	Product category	Product family	Part number	Specification & benefits
Main Control	Main control MCU	32-bit XMC1000 Industrial Microcontroller ARM® Cortex®-M0	XMC1302-Q040X0016 AB	- 6KB Flash, 16KB RAM, supply voltage range: 1.8 to 5.5 V, in PG-TSSOP-38, temperature range: -40 – 105°C
			XMC1402-Q048X0032 AA	- Core frequency: 48[MHZ], 34KB Flash, 16KB RAM, supply voltage range: 1.8 to 5.5 V, in PG-VQFN-48, temp range: -40 - 105°C
		PSOC™ 4 Arm® Cortex®-M0/M0+	CY8C4128FNI-BL563T	- Low-power, programmable mixed-signal hardware IP, bluetooth and industry leading CAPSENSE™
Condition monitoring & sensing	Liquid level detection MCU	PSOC™ 4000T Multi-Sense microcontroller	CY8C4045LQI-T412	- Capacitive and inductive sensing, liquid level sensing solution with ultra-low power and best in class signal-to-noise ratio
	Water pressure measurement	XENSIV™ pressure sensors	DPS368	- Fast, ultra-low noise read-out, precise measurement of air flow, ideal for harsh environments with water, dust, or humidit
	Position sensor Vertical load washing machine	XENSIV™ magnetic sensor	TLE5012B E5000	- Pre-calibrated angle sensor iGMR, economic with SPI compatible interface
Auxiliary power	Gate drivers	EiceDRIVER™	2EDB9259Y	- Up to 3000 Vrma VISO robust input-to-output isolation meeting UL1577 components standard, narrow-body 150 mil DSO-14 package
	Silicon carbide MOSFETs	CoolSiC™ MOSFET	IMBG65R050M2H	- 650 V, 50 mΩ G2 in a PG-D2PAK-7 / PG-TO-263-7, enabling BOM savings and system performance with highest reliability
	IGBT	TRENCHSTOP™ IGBT3	IKB06N60T	- 600 V, 6 A IGBT discrete with anti-parallel diode, PG-TO263, highest efficiency – low conduction and switching losses
	Silicon MOSFETs	CoolMOS™ 8 Superjunction (SJ) MOSFET	IPD60R600CM8	- 600 V, reduced gate charge (Qg) of 20% , turn-off losses (Eoss) further improved by 12%, reverse recovery charge (Qrr) is 3% lower compared to CFD7



4.6 Laundry machines & tumble dryers

Elevating performance with efficient, intelligent and secure trusted solutions

Functional block	Product category	Product family	Part number	Specification & benefits
Inverter motor control - Drum, heat pump, water pump	Inverter motor control up to 3 motors MCU	32-bit XMC7000 Industrial Microcontroller Arm® Cortex®-M7	XMC7100D-F144K2112AA	- Single/Dual 250-MHz Arm® Cortex®-M7 and 100MHz Cortex®-M0, up to 4-MB Flash, up to 768-kB SRAM, 7-V to 5.5-V supply voltage
	Simple motor control MCUs	PSOC™ Control Arm® Cortex®-M33 Main	PSC3M5FDS2ACQ1	- Integrating advance real-time control peripherals to provide designers the ability to improve performance of their next motor control products
	Single motor FOC MCUs	32-bit XMC1000 Industrial Microcontroller ARM® Cortex®-M0	XMC1302-Q040X0128 AB	- 128KB Flash, 16KB RAM, supply voltage range: 1.8 to 5.5 V, in PG-TSSOP-38, temperature range: -40 – 105°C
			XMC1404-Q064X0128 AA	- Core frequency: 48[MHZ], 128KB Flash, 16KB RAM, supply voltage range: 1.8 to 5.5 V, in PG-VQFN-48, temperature range: -40 - 105°C
			CY8C4146AZS-S265	- ISO 26262-ready, core frequency: 48[MHZ], 64KB Flash, 8KB RAM, supply voltage range: 1.71 to 5.5 V, temperature range: -40 – 105°C. With CAPSENSE™
			CY8C4127AZI-S443	- Core frequency: 24[MHZ], 128KB Flash, 16KB RAM, supply voltage range: 1.71 to 5.5 V, temperature range: -40 – 85°C
	Single or dual motor MCUs	PSOC™ Control Arm® Cortex®-M33 Main	PSC3M5FDS2AFQ1	- Newest MCU's developed specifically for motor control applications
			PSOC™ Control C3M	- Integrating advance real-time control peripherals to provide designers the ability to improve performance of their next motor control products
	Current sensors	XENSIV™ current sensor	TLI4971-A120T5-U-E0001	- High precision miniature coreless magnetic current sensor for AC and DC measurements, 120 A, 3.45 %, 3.1 – 3.5 V
	Silicon Integrated Power Module (IPM) 1x	CIPOS™ Micro IPMs	here	- Family of compact, three-phase, intelligent power modules for low-power (i.e. up to 450 Watts with heatsink) motor drive applications
CIPOS™ Mini IPMs		here	- Family of high efficient intelligent power modules that has the highest power density with 4A to 30A rated products built into single package platform	



4.6 Laundry machines & tumble dryers

Elevating performance with efficient, intelligent and secure trusted solutions

Functional block	Product category	Product family	Part number	Specification & benefits
Inverter motor control - Drum, heat pump, water pump	GaN IPS integrated gate driver + HEMT 2x-3x	coming soon		
	Gate drivers	EiceDRIVER™ Half bridge	2ED2388S06F	- 650 V high speed, half-bridge gate driver with typical 0.29 A source and 0.7 A sink currents, PG-DSO-8, 50 % lower level-shift losses
		EiceDRIVER™ Compact - Full bridge 3	6EDL04I06NT	- 600 V three-phase gate driver IC with integrated bootstrap diode, over current protection, enable and fault reporting, PG-DSO-28
	GaN discrete HEMTs	CoolGaN™ transistors	IGT65R055D2	- 650 V e-mode power transistor, supporting high operating frequency, bottom-side cooled TOLL package
	Gate drivers	EiceDRIVER™ drivers	2EDB7259Y	- 5 A/9 A source/sink dual-channel gate driver, with a very high 150 V/ns CMTI for robust operation with CoolMOS™, CoolGaN™ GIT HEMTs in high-power switching noise environment
2ED21064S06J			- 650 V, 0.7 A high-side and low-side gate driver with integrated bootstrap diode, space saving PG-DSO-14, excellent ruggedness	
Inverter motor control - Drum, heat pump, water pump	Gate drivers + IGBT	RC Drivers 2	IKD06N60RC2	- 600 V, 6 A IGBT Discrete with Reverse Conducting Drive 2-diode, PG-TO-252
			2ED2304S06F	- 650 V SOI half-bridge gate driver IC, integrated Bootstrap Diode for IGBTs and MOSFETs with 0.36 A source and 0.7 A sink currents, PG-DSO-8
	IGBTs	600 V Reverse Conducting Drive 2	here	- RC-D2 with the monolithically integrated diode offers improvements of the performance, controllability and reliability compared to the RC-DF
		TRENCHSTOP™ IGBT6	here	- 1200 V IGBT technology optimized for applications with high speed switching applications operating in range from 15 kHz to 40 kHz
		TRENCHSTOP™ IGBT7	here	- High voltage IGBTs, specially designed for variable speed drives, offering high level of controllability
TRENCHSTOP™ IGBT3	IKW20N60H3	- 600 V, 20 A hard-switching TRENCHSTOP™ IGBT3 co-packed with free-wheeling diode, PG-TO247, low switching and conduction losses		



4.6 Laundry machines & tumble dryers

Elevating performance with efficient, intelligent and secure trusted solutions

Functional block	Product category	Product family	Part number	Specification & benefits
Security	Security solutions	OPTIGA™ Trust security solutions	OPTIGA TRUST M SLS32AIA	- CC EAL 6+ (high) certified tamper-resistant hardware, used with any MCU/MPU or application processor to perform various security-related tasks autonomously
			OPTIGA TRUST M MTR	- Discrete security solution combined with a Matter-certified provisioning service late-stage personalized Device Attestation Certificate (DAC) for download
			OPTIGA TRUST M EXPRESS	- Pre-provisioned Secure Element, ready to connect to Azure and AWS - Automated device and product-to-cloud provisioning
Connectivity & Matter	Dual/tri-band 2.4GHz, 5.0GHz & 6.0GHz Wi-Fi 6 & Bluetooth®	AIROC™ Wi-Fi + Bluetooth® Combos	CYW55513	- Wi-Fi 6 / 6E Tri-Band Wi-Fi and Bluetooth® / Bluetooth® Low-Energy 5.4 Combo IC, greenfield 6GHz band for expanded channels
			CYW55571	- Wi-Fi 6E tri-band Wi-Fi and Bluetooth® 5.3 SoC, high-performance beyond Wi-Fi 6/6e requirements
			CYW55572	- Wi-Fi 6 dual-band 2x2 Wi-Fi and Bluetooth® 5.3 SoC, Bluetooth® LE audio delivers high-quality audio
			CYW55573	- Wi-Fi 6/6E tri-band 2x2 Wi-Fi and Bluetooth® 5.3 SoC, multi-layer security & network intelligence for greater protection
	Legacy Dual Band 2.4GHz & 5.0GHz Wi-Fi 4 & Bluetooth®		CYW43022	- Ultra-low Power 1x1 Dual-band Wi-Fi 5 (802.11ac) + Bluetooth® 5.4 combo, best-in-class power consumption
	Matter Hosted Tri Band 2.4GHz, 5.0GHz & 6.0GHz Wi-Fi 6 & BT®		CYW55913	- Ultra-low power single-chip connected MCU that supports 1x1 2.4+5+6GHz Wi-Fi 6E, Bluetooth® Low Energy 5.4, and Matter
	Industrial qualified Wi-Fi 5 & Bluetooth®		CYW4373	- 1x1 Dual-band Wi-Fi 5 (802.11ac) + Bluetooth® 5.4 combo, 2.4 GHz and 5 GHz Wi-Fi 5 (802.11ac)



4.6 Laundry machines & tumble dryers

Elevating performance with efficient, intelligent and secure trusted solutions

Functional block	Product category	Product family	Part number	Specification & benefits
HMI	HMI MCU	PSoC™ 4000 - Entry-Level	CY8C4045LQI-T412	- Capacitive sensing, Inductive sensing, liquid level sensing solution with ultra-low power and best in class signal-to-noise ratio
	Memory	SEMPER™ Nano NOR Flash	here	- Family of NOR flash for hearables, wearables, and IoT endpoints with solutions hub incl. Software dev kits, hardware dev platforms and more
	Display control	PSoC™ Edge Arm® Cortex® Multicore Microcontroller	here	- High performance Arm® Cortex®-M55, including Helium™ DSP support paired with Arm® Ethos™-U55 and Cortex-M33 paired Infineon's ultra-low power NNLite neural network accelerator
	Voice control MEMS microphones	XENSIV™ MEMS microphone	IM72D128V	- Ultra-high performance, high SNR of 71.5dB, far-field & low volume audio pick-up, clear audio signals even for highest SPL
	Presence, gesture, and material detection	XENSIV™ 60GHz radar sensor	BGT60TR13C	- 60GHz radar sensor with integrated antennas, ultra-wide bandwidth of 5.5 GHz a very low range resolution down to ~3cm



4.7 Refrigerators & freezers

High-performance system solution for better efficiency, lower cost

Consumers demand refrigerators and freezers with low energy consumption, minimal noise, compact designs, and maximum storage space. They also seek intelligent appliances that integrate seamlessly into home networks. Manufacturers must balance stricter energy efficiency regulations while achieving smaller system design, lower cost and smarter features.

Infineon offers the needed components to make state-of-the-art motor control solutions for refrigerator compressor, from power devices including IPMs, discrete (IGBTs, MOSFETs) and advanced GaN device, to high-performance MCUs and gate drivers.

For motor control, Infineon – a leader in power, offers a wide range of power components for motor inverter design. Both TRENCHSTOP™ IGBTs and CoolMOS™ MOSFETs are recommended as discrete while CoolMOS™ enables higher efficiency at light load under which condition refrigerators normally operate. EiceDRIVER™ gate driver is a good fit here to drive various power discrete. CIPOS™ modules integrate power and control components to improve reliability, optimize board size, and accelerate time-to-market. For designs aiming for best system performance, CoolGaN™ based motor inverter design is new option. As for motor controllers, Infineon's PSOC™ and XMC™ microcontroller families are recommended. The CoolSET™ family supports auxiliary power supply with increased robustness.

Infineon's components, including PSOC™ microcontrollers, AIROC™ Wi-Fi + Bluetooth® Combos, XENSIV™ sensors and OPTIGA™ security ICs, enhance smart refrigerator capabilities. They enable smart, connected refrigerators and freezers that can sense the environment, provide user and manufacturer data for remote analysis, and ensure secured communication.

These solutions enhance efficiency, compactness, and carbon footprint, leveraging a robust product portfolio to meet diverse application needs.

Features and benefits

Key features

- Comprehensive compressor motor control solutions ranging from cost optimized design to high performance design
- Broad range of power solutions ranging from discrete to integrated modules, from Si to GaN
- State-of-the-art microcontroller with mature CAPSENSE™ capacitive touch sensor and MCU for AI/ML capabilities with PSOC™
- Robust and reliable wireless connectivity ranges from Wi-Fi 4 to Wi-Fi 6/6E, compliant to Matter over Wi-Fi and Matter over Thread
- XENSIV™ sensor solutions cover a wide range of use cases, enabling smart features
- OPTIGA™ Trust M hardware cryptographic accelerators support host MCUs with Matter onboarding

Key benefits

- Different system designs enable high energy efficiency, compact design and system cost savings
- Enhanced energy efficiency, higher power density and optimized system design at reduced BOM cost
- Enhance responsiveness and reliability, ultra-low power operation, liquid immunity functionalities
- Flexible usage, future-proof and full compatibility and wireless connectivity integration
- Contextual awareness and advanced sensing solutions such as presence detection, voice control, food freshness monitoring
- Enhanced, robust security for higher cryptographic operations





4.7 Refrigerators & freezers

High-performance system solution for better efficiency, lower cost

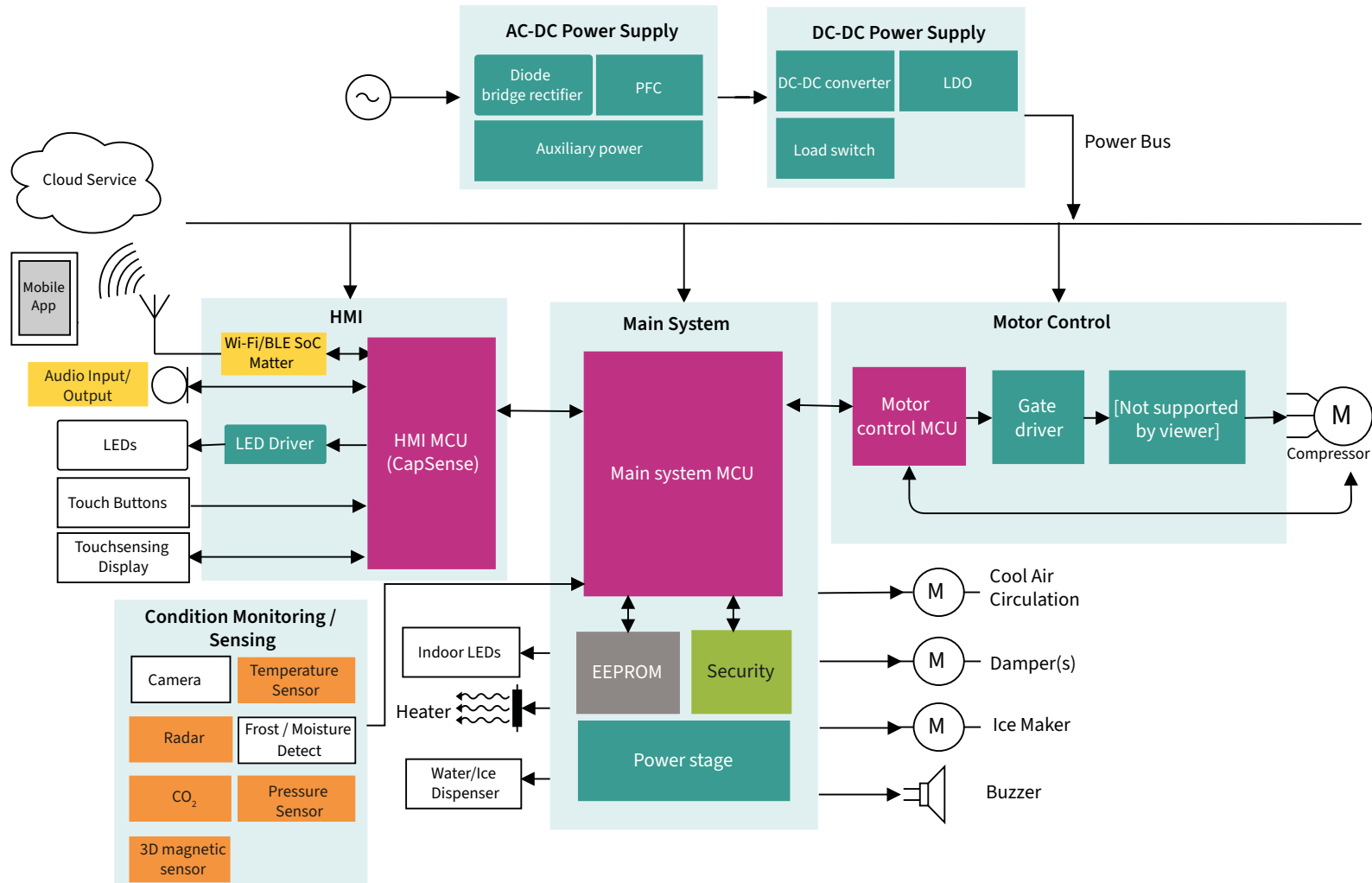

Click here to learn more: www.infineon.com/refrigerator



4.7 Refrigerators & freezers

High-performance system solution for better efficiency, lower cost

Cost optimized motor control kit for refrigerator compressors REF-MHA0K3IRC2PSOC4

The REF-MHA0K3IRC2PSOC4 reference board replaces the large electrolytic capacitors with small capacity film capacitors by stabilizing the DC voltage output through an intelligent motor control algorithm. This improves the control board operating lifetime by eliminating the electrolytic capacitors while reducing the board size and total BoM cost.

The reference kit is a 200 W single shunt evaluation board using Infineon high performance power component and microcontrollers. It has a reduced board size and cost by using intelligent motor control algorithms and film capacitors instead of electrolytic capacitors.

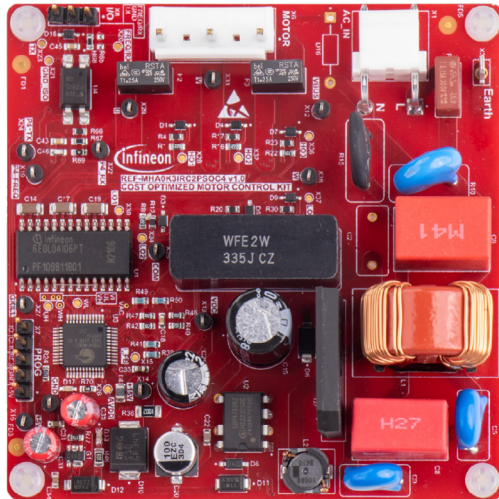

Features and benefits

Feature

- Input voltage 176-265 Vrms, auxiliary power supply on-board
- Maximum 200 W motor power output
- Onboard EMI filter & single-shunt current sensing

Benefit

- Lower costs: BOM cost and board size are reduced
- Faster time-to-market: Ready-to-use full solution and intelligent motor control algorithms help reduce high harmonics and improve power factor without active PFC
- Longer operating lifetime: Improved reliability by replacing electrolytic capacitors with CBB capacitors



Click here to learn more:
[REF-MHA0K3IRC2PSOC4](#)



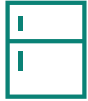

4.7 Refrigerators & freezers

High-performance system solution for better efficiency, lower cost

Functional block	Product category	Product family	Part number	Specification & benefits
AC-DC Power Supply	Diode bridge rectifier	CoolSiC™ diodes	here	- Family of Silicon Carbide CoolSiC™ Schottky Diode solutions 600-650-1200-2000 V
	PWM-PFC	TRENCHSTOP™ 5 IGBT	IKP08N65H5	- 650 V, 8 A IGBT with anti-parallel diode, PG-TO-220, copacked with fast and soft RAPID 1 anti-parallel diode
		EiceDRIVER™ Gate driver	1ED44173N01B	- 25 V single-channel low-side MOSFET gate driver with integrated fast over-current protection (OCP), 2.6 A, PG-SOT23
		Silicon Diodes	IDP08E65D1	- 650 V silicon power diode, for applications switching between 18 kHz and 40 kHz, PG-TO-220 real2pin
		CIPOS™ Mini IPMs	here	- Family of high efficient intelligent power modules that has the highest power density with 4A to 30A rated products built into single package platform
		CoolSET™ Quasi Resonant PWM-QR (quasi resonant) Flyback lcs	ICE5QR1680BG ICE5QSBG	- 5th generation quasi-resonant CoolSET™ with integrated 800V CoolMOS™ SJ MOSFET, PG-SMD - High performance and comprehensive suite of protection to increase system robustness, PG-DSO-8
		CoolMOS™ MOSFET	IPA80R600P7	- 800 V, up to 0.6% efficiency gain and 2°C to 8°C lower MOSFET , PG-TO220 FullPAK
DC-DC Power Supply	LDO	OPTIREG™ linear LDO	here	- Family of robust linear voltage regulators
Connectivity & Matter	Wi-Fi/BLE SoC Matter	AIROC™ Wi-Fi + Bluetooth® Combos Wi-Fi 4 (802.11n)	CYW43438 , CYW43439 CYW43012	- 1x1 single-band 2.4 GHz Wi-Fi 4 (802.11n) and Bluetooth® 5.1, 20 MHz channels, up to 96 Mbps PHY data rate incl.ModusToolbox with libraries and more - 1x1 dual-band 2.4 GHz and 5 GHz Wi-Fi 4 (802.11n) and Bluetooth® 5.4, MCS8 (256-QAM) for 20MHz channels, up to 78Mbps PHY data rate
		AIROC™ Wi-Fi + Bluetooth® Combos Wi-Fi 5 (802.11ac)	CYW4373	- 1x1 Dual-band Wi-Fi 5 (802.11ac) + Bluetooth® 5.4 combo, 2.4 GHz and 5 GHz Wi-Fi 5 (802.11ac)
		AIROC™ Wi-Fi + Bluetooth® Combos Wi-Fi 6/6E (802.11ax)	CYW55513	- Wi-Fi 6 / 6E Tri-Band Wi-Fi and Bluetooth® / Bluetooth® Low-Energy 5.4 Combo IC, greenfield 6GHz band for expanded channels
		AIROC™ Bluetooth® LE	CYW20829	- Bluetooth® LE 5.4 MCU with Industry's best range, Dual ARM Cortex M33 dedicated for applications and CAN FD

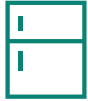

4.7 Refrigerators & freezers

High-performance system solution for better efficiency, lower cost

Functional block	Product category	Product family	Part number	Specification & benefits
HMI	Capacitive touch sensing controller	32-bit PSOC™ 4 Arm® Cortex®-M0 MCU	CY8C4046LQI-T452	- MCU with capacitive and inductive sensing, liquid level sensing solution with ultra-low power and best-in-class signal-to-noise ratio
		32-bit PSOC™ 6 Arm® Cortex®-M4 MCU	CY8C6244LQI-S4D82	- 62x4 product family offers 256 KB of flash, 128 KB of SRAM, rich set of analog peripherals operating in device deep sleep mode
Condition Monitoring and sensing	Audio Input/Output	XENSIV™ MEMS microphone	IM73A135	- Ultra-high performance, high SNR of 73dB, high ingress protection (IP57) at a microphone level, clear audio pick up of the quietest/loudest sounds
	Radar	XENSIV™ 60 GHz radar sensor	BGT60LTR11AIP	- 60 GHz, small, 3.3 × 6.7 × 0.56-mm ³ MMIC with integrated antennas, configurable detection range from 0.5 m up to 7 m with a typical human target Radar Cross Section (RCS)
	Environmental sensor	XENSIV™ PASCO2	PASCO2V01	- CO ₂ sensor based on photoacoustic spectroscopy (PAS), highest accuracy and robust performance at ppm level (±30 ppm ±3% of reading), small form-factor
	Pressure sensor	XENSIV™ pressure sensor	DPS368	- Fast, ultra-low noise read-out allows for precise measurement of air flow, ideal for harsh environments with water, dust, or humidit
	3D magnetic sensor	XENSIV™ magnetic sensor	TLE4961-1L	- Hall latch, for superior supply voltage capability requiring applications, 3.0 V to 32 V operating supply voltage, PG-SSO3-2
Main System	Microcontroller	32-bit PSOC™ 4 Arm® Cortex®-M0 MCU	CY8C4146AZI-S423	- MCU with low-power, programmable mixed-signal hardware IP, 24[MHZ], 64KB Flash, 8KB RAM, supply voltage range: 1.71 to 5.5 V, temperature range: -40 85°C
		32-bit PSOC™ 6 Arm® Cortex®-M4 MCU	CY8C6244LQI-S4D82	- 62x4 product family offers 256 KB of flash, 128 KB of SRAM, rich set of analog peripherals operating in device deep sleep mode
		PSOC™ Edge E8x for edge computing functions	here	- Based on high performance Arm® Cortex®-M55, including Helium™ DSP support paired with Arm® Ethos™-U55 and Cortex-M33 paired Infineon's ultra-low power NNlite neural network accelerator
	Memory	SEMPER™ Nano NOR Flash	S25FS256TDAWEC119	- 256Mb SEMPER™ Nano 1.8V QSPI Flash in known good wafer format, compact footprint, build-in ECC
	Security	OPTIGA™ Trust security solutions	OPTIGA TRUST M SLS32AIA	- CC EAL 6+ (high) certified tamper-resistant hardware, used with any MCU/MPU or application processor to perform various security-related tasks autonomously

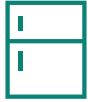

4.7 Refrigerators & freezers

High-performance system solution for better efficiency, lower cost

Functional block	Product category	Product family	Part number	Specification & benefits
Motor Control	Motor control MCU	32-bit XMC1000 Industrial Microcontroller ARM® Cortex®-M0	here	- Family of MCU Arm® Cortex®-M0 core, up to 48MHz and 80 CoreMark, control peripherals like PWM timers run on up to 96MHz
		32-bit PSOC™ 4 Arm® Cortex®-M0 MCU	CY8C4146AZI-S423	- MCU with low-power, programmable mixed-signal hardware IP, 24[MHZ], 64KB Flash, 8KB RAM, supply voltage range: 1.71 to 5.5 V, temperature range: -40 85°C
	Gate driver	EiceDRIVER™	2ED2304S06F	- 650 V Half Bridge Gate Driver IC with Integrated Bootstrap Diode, 0.36 A source and 0.7 A sink currents, PG-DSO-8
			6EDL04I06PT	- 600 V full-bridge three-phase gate driver IC for MOS-transistors or IGBTs, PG-DSO-28 with LS-SOI technology
	Power device (MOSFET/ IGBT/IPM/GaN)	CoolMOS™ PFD7 Superjunction MOSFET	IPD60R600PFD7S	- 600 V, features RDS(on) of 600mOhm, minimized switching losses, PG-TO-252 DPAK
			IPN60R600PFD7S	- 600 V, features RDS(on) of 600mOhm PG-SOT-223
			IPD60R360PFD7S	- 600 V, features RDS(on) of 360mOhm, minimized switching losses, PG-TO-252 DPAK
			IPN60R360PFD7S	- 600 V, features RDS(on) of 360mOhm, PG-SOT-223
		600 V CoolMOS™ 8	IPD60R600CM8	- 600 V, reduced gate charge (Qg) of 20%, reduction in turn-off losses (Eoss) improved by 12%, reverse recovery charge (Qrr) 3% compared to CFD7
		CoolGaN™ Transistors	IGI60L5050B1M	- 500 mΩ / 600 V GaN transistor in half-bridge configuration with integrated level-shift gate driver and bootstrap diode, 6x8mm PG-TFLGA-27
		600V/1200V TRENCHSTOP™	IKD06N60RC2	- 600 V, 6 A IGBT Discrete with Reverse Conducting Drive 2-diode, low switching losses on competitive price, PG-TO-252
			IKD04N60RC2	- 600 V, 4 A IGBT Discrete with Reverse Conducting Drive 2-diode, low switching losses on competitive price, PG-TO-252
	CIPOS™ Micro	IM241-L6S1B	- 600 V, 6 A three-phase RCD2 IGBT, open emitter, PG-SOP 29x12, fully-featured with multiple protection functions	
	CIPOS™ Mini	IM523-S6A	- 600 V, 6 A three-phase TRENCHSTOP™ RCD2 IGBT, open emitter in PG-DIP 36x21, control three-phase motors in variable speed drive in low and medium power	

Contact

Published by
Infineon Technologies AG
Am Campeon 1-15, 85579 Neubiberg
Germany

© 2025 Infineon Technologies AG.
All rights reserved.

Public

Date: 03 / 2025



Stay connected!



Scan QR code and explore offering
www.infineon.com

Please note!

This Document is for information purposes only and any information given herein shall in no event be regarded as a warranty, guarantee or description of any functionality, conditions and/or quality of our products or any suitability for a particular purpose. With regard to the technical specifications of our products, we kindly ask you to refer to the relevant product data sheets provided by us. Our customers and their technical departments are required to evaluate the suitability of our products for the intended application.

We reserve the right to change this document and/or the information given herein at any time.

Additional information

For further information on technologies, our products, the application of our products, delivery terms and conditions and/or prices, please contact your nearest Infineon Technologies office (www.infineon.com).

Warnings

Due to technical requirements, our products may contain dangerous substances. For information on the types in question, please contact your nearest Infineon Technologies office.

Except as otherwise explicitly approved by us in a written document signed by authorized representatives of Infineon Technologies, our products may not be used in any life-endangering applications, including but not limited to medical, nuclear, military, life-critical or any other applications where a failure of the product or any consequences of the use thereof can result in personal injury.