

## CoolSiC™ M1

PG-TO247-3

### CoolSiC™ MOSFET 650 V G1

The 650 V CoolSiC™ is built over the solid silicon carbide technology developed in Infineon in more than 20 years. Leveraging the wide bandgap SiC material characteristics, the 650V CoolSiC™ MOSFET offers a unique combination of performance, reliability and ease of use. Suitable for high temperature and harsh operations, it enables the simplified and cost effective deployment of the highest system efficiency.

## Features

- Optimized switching behavior at higher currents
- Commutation robust fast body diode with low  $Q_{fr}$
- Superior gate oxide reliability
- $T_{j,max}=175^{\circ}\text{C}$  and excellent thermal behavior
- Lower  $R_{DS(on)}$  and pulse current dependency on temperature
- Increased avalanche capability
- Compatible with standard drivers
- Kelvin source provides up to 4 times lower switching losses

## Benefits

- Unique combination of high performance, high reliability and ease of use
- Ease of use and integration
- Suitable for topologies with continuous hard commutation
- Higher robustness and system reliability
- Efficiency improvement
- Reduced system size leading to higher power density

## Potential applications

- SMPS
- UPS (uninterruptable power supplies)
- Solar PV inverters
- EV charging infrastructure
- Energy storage and battery formation
- Class D amplifiers

## Product validation

Fully qualified according to JEDEC for Industrial Applications

**Table 1** Key performance parameters

Parameter	Value	Unit
$V_{DS} @ T_J = 25^{\circ}\text{C}$	650	V
$R_{DS(on),typ}$	39	m $\Omega$
$R_{DS(on),max}$	50	m $\Omega$
$Q_{G,typ}$	41	nC
$I_{DM,max}$	123	A
$Q_{oss} @ 400\text{ V}$	97	nC
$E_{oss} @ 400\text{ V}$	14.6	$\mu\text{J}$

Part number	Package	Marking	Related links
IMW65R039M1H	PG-TO247-3	65R039M1	see Appendix A

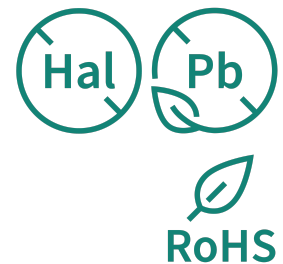
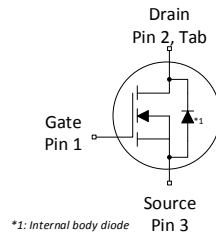
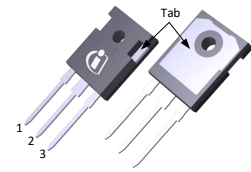

## Table of contents

Description .....	1
Maximum ratings .....	3
Thermal characteristics .....	4
Operating range .....	5
Electrical characteristics .....	6
Electrical characteristics diagrams .....	8
Test circuits .....	13
Package outlines .....	14
Appendix A .....	15
Revision history .....	16
Trademarks .....	16
Disclaimer .....	16

## 1 Maximum ratings

at  $T_j = 25\text{ °C}$ , unless otherwise specified.

Note: for optimum lifetime and reliability, Infineon recommends operating conditions that do not exceed 80% of the maximum ratings stated in this datasheet.

**Table 2 Maximum ratings**

Parameter	Symbol	Values			Unit	Note / Test condition
		Min.	Typ.	Max.		
Continuous DC drain current <sup>1)</sup>	$I_{\text{DC}}$	-	-	46 35	A	$T_c = 25\text{ °C}$ $T_c = 100\text{ °C}$
Peak drain current <sup>2)</sup>	$I_{\text{DM}}$	-	-	123	A	$T_c = 25\text{ °C}$ , $V_{\text{GS}} = 18\text{ V}$
Avalanche energy, single pulse	$E_{\text{AS}}$	-	-	213	mJ	$I_{\text{D}} = 8\text{ A}$ , $V_{\text{DD}} = 50\text{ V}$ ; see table 11
Avalanche energy, repetitive	$E_{\text{AR}}$	-	-	1.06	mJ	
Avalanche current, single pulse	$I_{\text{AS}}$	-	-	8.0	A	-
MOSFET $dv/dt$ ruggedness	$dv/dt$	-	-	200	V/ns	$V_{\text{DS}} = 0 \dots 400\text{ V}$
Gate source voltage (static) <sup>3)</sup>	$V_{\text{GS}}$	-5	-	23	V	-
Gate source voltage (transient)	$V_{\text{GS}}$	-7	-	25	V	$t_{\text{pulse}} \leq 1\%$ duty cycle/ $f_{\text{sw}}$
Power dissipation	$P_{\text{tot}}$	-	-	176	W	$T_c = 25\text{ °C}$
Storage temperature	$T_{\text{stg}}$	-55	-	150	°C	-
Operating junction temperature	$T_j$	-55	-	175	°C	-
Mounting torque	-	-	-	60	Ncm	M3 and M3.5 screws
Continuous reverse drain current <sup>1)</sup>	$I_{\text{SDC}}$	-	-	46 31	A	$V_{\text{GS}} = 18\text{ V}$ , $T_c = 25\text{ °C}$ $V_{\text{GS}} = 0\text{ V}$ , $T_c = 25\text{ °C}$
Peak reverse drain current <sup>2)</sup>	$I_{\text{SM}}$	-	-	123	A	$T_c = 25\text{ °C}$ , $t_p \leq 250\text{ ns}$
Insulation withstand voltage	$V_{\text{ISO}}$	-	-	n.a.	V	$V_{\text{rms}}$ , $T_c = 25\text{ °C}$ , $t = 1\text{ min}$

1) Limited by  $T_{j,\text{max}}$

2) Pulse width  $t_{\text{pulse}}$  limited by  $T_{j,\text{max}}$ .

3) The maximum gate-source voltage in the application design should be in accordance to IPC-9592B.

## 2 Thermal characteristics

**Table 3 Thermal characteristics**

Parameter	Symbol	Values			Unit	Note / Test condition
		Min.	Typ.	Max.		
Thermal resistance, junction - case	$R_{th(j-c)}$	-	-	0.85	°C/W	-
Thermal resistance, junction - ambient	$R_{th(j-a)}$	-	-	62	°C/W	Leaded
Thermal resistance, junction - ambient, SMD version	$R_{th(j-a)}$	-	-	-	°C/W	n.a.
Soldering temperature, wavesoldering only allowed at leads	$T_{sold}$	-	-	260	°C	1.6mm (0.063 in.) from case for 10s

### 3 Operating range

**Table 4 Operating range**

Parameter	Symbol	Values			Unit	Note / Test condition
		Min.	Typ.	Max.		
Gate-source voltage operating range including undershoots <sup>4)</sup>	$V_{GS}$	-2	-	20	V	-
Recommended turn-on voltage	$V_{GS(on)}$	-	18	-	V	
Recommended turn-off voltage	$V_{GS(off)}$	-	0	-	V	

4)

**Important notice:** If the gate source voltage of the device in application exceeds the operating range (Table 4), the device  $R_{DS,on}$  and  $V_{GS(th)}$  might exceed the maximum value stated in the datasheet at the end of the lifetime of the device. In order to ensure sound operation of the device over the planned lifetime, the maximum ratings (Table 2) and the CoolSiC™ MOSFET 650V M1 trench power device application note AN\_1907\_PL52\_1911\_144109 must be considered.

## 4 Electrical characteristics

at  $T_j = 25\text{ °C}$ , unless otherwise specified

**Table 5 Static characteristics**

Parameter	Symbol	Values			Unit	Note / Test condition
		Min.	Typ.	Max.		
Drain-source voltage	$V_{DSS}$	650	-	-	V	$V_{GS} = 0\text{ V}$ , $I_D = 0.75\text{ mA}$
Gate threshold voltage <sup>5)</sup>	$V_{GS(th)}$	3.5	4.5	5.7	V	$V_{DS} = V_{GS}$ , $I_D = 7.5\text{ mA}$
Zero gate voltage drain current	$I_{DSS}$	-	1 3	100 -	$\mu\text{A}$	$V_{DS} = 650\text{ V}$ , $V_{GS} = 0\text{ V}$ , $T_j = 25\text{ °C}$ $V_{DS} = 650\text{ V}$ , $V_{GS} = 0\text{ V}$ , $T_j = 175\text{ °C}$
Gate-source leakage current	$I_{GSS}$	-	-	100	nA	$V_{GS} = 20\text{ V}$ , $V_{DS} = 0\text{ V}$
Drain-source on-state resistance	$R_{DS(on)}$	-	39 55	50 -	$\text{m}\Omega$	$V_{GS} = 18\text{ V}$ , $I_D = 25\text{ A}$ , $T_j = 25\text{ °C}$ $V_{GS} = 18\text{ V}$ , $I_D = 25\text{ A}$ , $T_j = 175\text{ °C}$
Internal gate resistance	$R_{G,int}$	-	5.0	-	$\Omega$	$f = 1\text{ MHz}$

<sup>5)</sup> Tested after 1 ms pulse at  $V_{GS} = +20\text{ V}$

**Table 6 Dynamic characteristics**

Parameter	Symbol	Values			Unit	Note / Test condition
		Min.	Typ.	Max.		
Input capacitance	$C_{iss}$	-	1393	-	pF	$V_{GS} = 0\text{ V}$ , $V_{DS} = 400\text{ V}$ , $f = 250\text{ kHz}$
Reverse transfer capacitance	$C_{rss}$	-	15	-	pF	
Output capacitance <sup>6)</sup>	$C_{oss}$	-	160	208	pF	
Output charge <sup>6)</sup>	$Q_{oss}$	-	97	126	nC	calculation based on $C_{oss}$
Effective output capacitance, energy related <sup>7)</sup>	$C_{o(er)}$	-	182	-	pF	$V_{GS} = 0\text{ V}$ , $V_{DS} = 0 \dots 400\text{ V}$
Effective output capacitance, time related <sup>8)</sup>	$C_{o(tr)}$	-	241	-	pF	$I_D = \text{constant}$ , $V_{GS} = 0\text{ V}$ , $V_{DS} = 0 \dots 400\text{ V}$
Turn-on delay time	$t_{d(on)}$	-	11.5	-	ns	$V_{DD} = 400\text{ V}$ , $V_{GS} = 0/18\text{ V}$ , $I_D = 25\text{ A}$ , $R_{G,ext} = 1.8\text{ }\Omega$ ; see table 10
Rise time	$t_r$	-	22	-	ns	
Turn-off delay time	$t_{d(off)}$	-	19	-	ns	
Fall time	$t_f$	-	7.0	-	ns	

<sup>6)</sup> Maximum specification is defined by calculated six sigma upper confidence bound

<sup>7)</sup>  $C_{o(er)}$  is a fixed capacitance that gives the same stored energy as  $C_{oss}$  while  $V_{DS}$  is rising from 0 to 400 V.

<sup>8)</sup>  $C_{o(tr)}$  is a fixed capacitance that gives the same charging time as  $C_{oss}$  while  $V_{DS}$  is rising from 0 to 400 V.

**Table 7 Gate charge characteristics**

Parameter	Symbol	Values			Unit	Note / Test condition
		Min.	Typ.	Max.		
Plateau gate to source charge	$Q_{GS(pl)}$	-	11	-	nC	$V_{DD} = 400\text{ V}$ , $I_D = 25\text{ A}$ , $V_{GS} = 0\text{ to }18\text{ V}$
Gate to drain charge	$Q_{GD}$	-	9	-	nC	
Total gate charge	$Q_G$	-	41	-	nC	

**Table 8 Reverse diode characteristics**

Parameter	Symbol	Values			Unit	Note / Test condition
		Min.	Typ.	Max.		
Drain-source reverse voltage	$V_{SD}$	-	4.0	-	V	$V_{GS} = 0\text{ V}$ , $I_S = 25\text{ A}$ , $T_j = 25\text{ °C}$
MOSFET forward recovery time	$t_{fr}$	-	30	-	ns	$V_{DD} = 400\text{ V}$ , $I_S = 25\text{ A}$ , $di_S/dt = 1000\text{ A}/\mu\text{s}$ ; see table 9
MOSFET forward recovery charge <sup>9)</sup>	$Q_{fr}$	-	160	-	nC	
MOSFET peak forward recovery current	$I_{frm}$	-	10.5	-	A	

<sup>9)</sup>  $Q_{fr}$  includes  $Q_{oss}$

## 5 Electrical characteristics diagrams

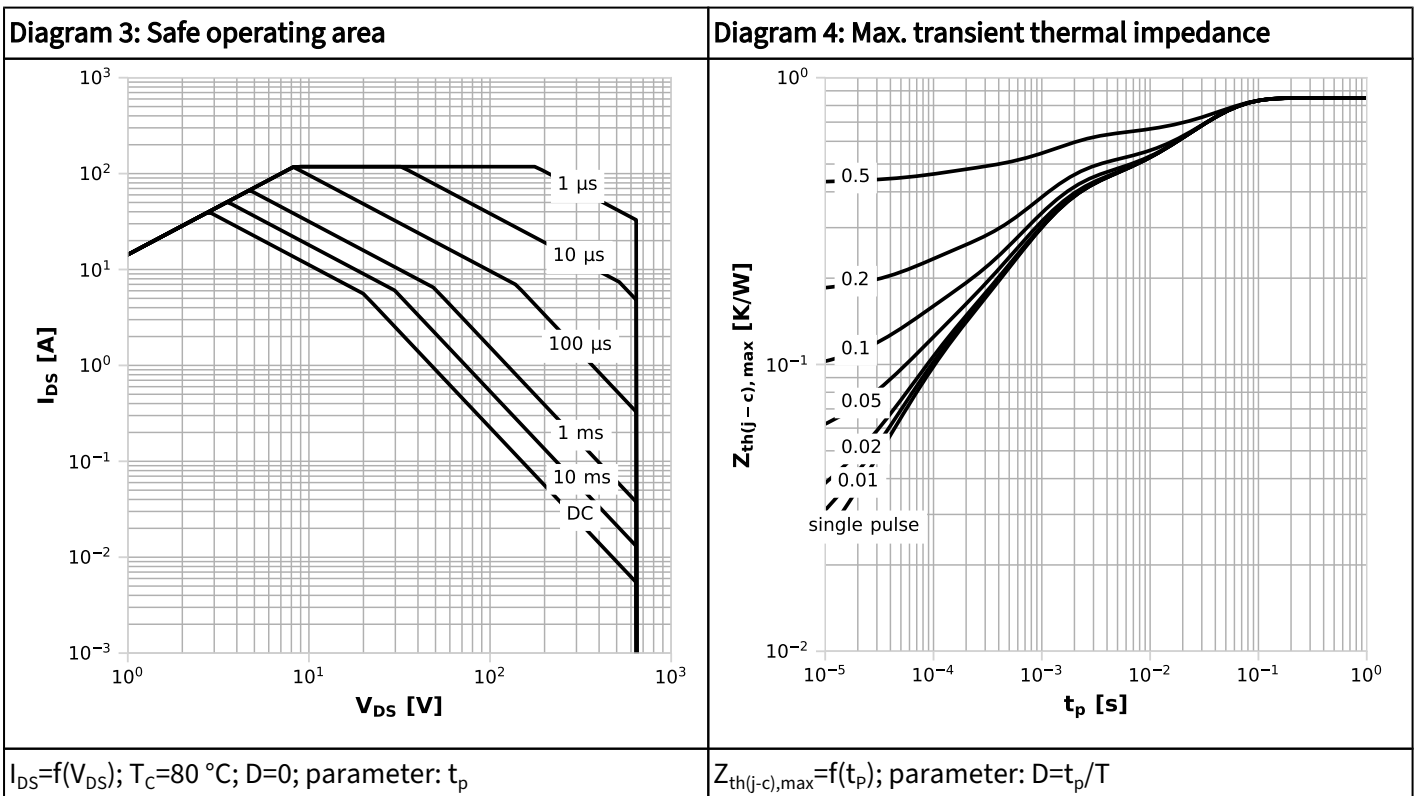
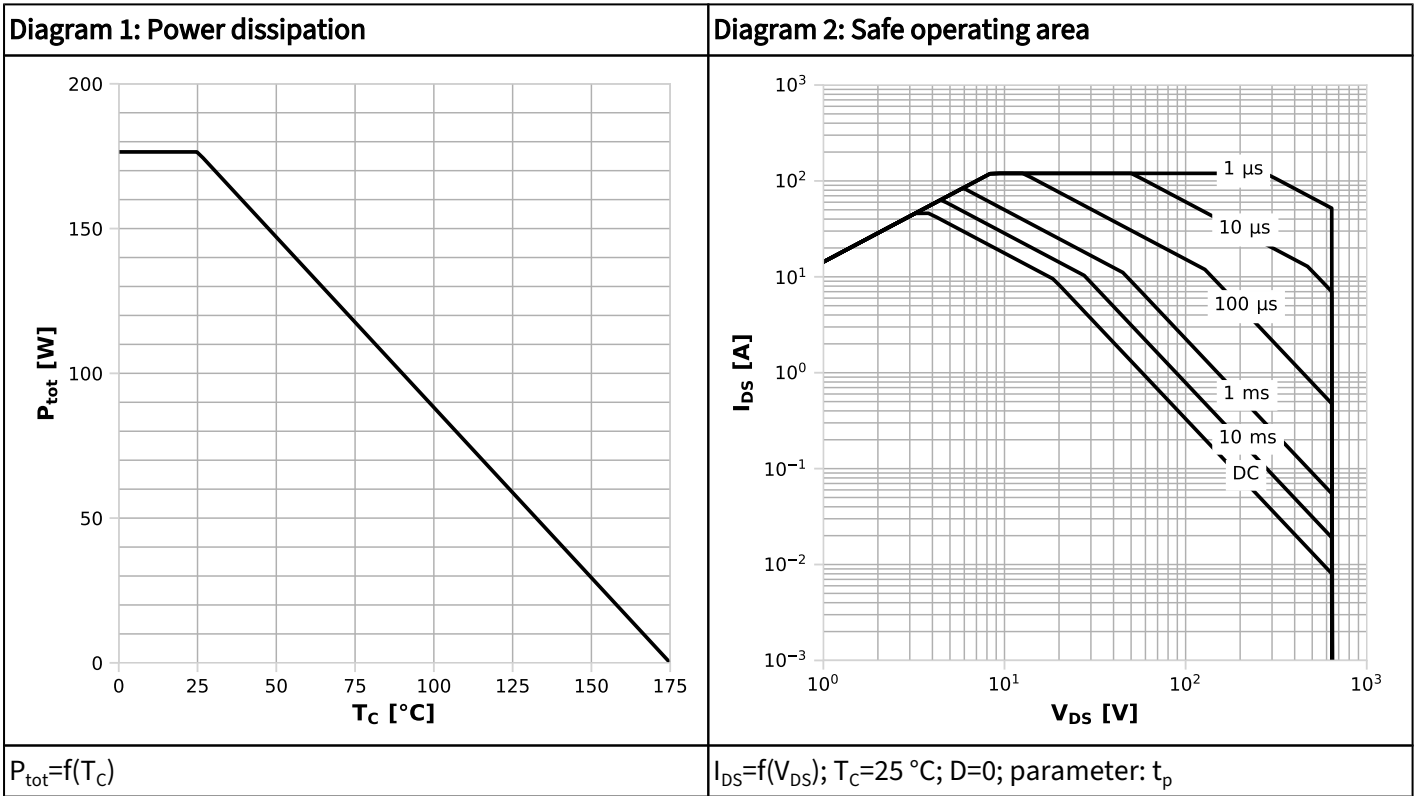
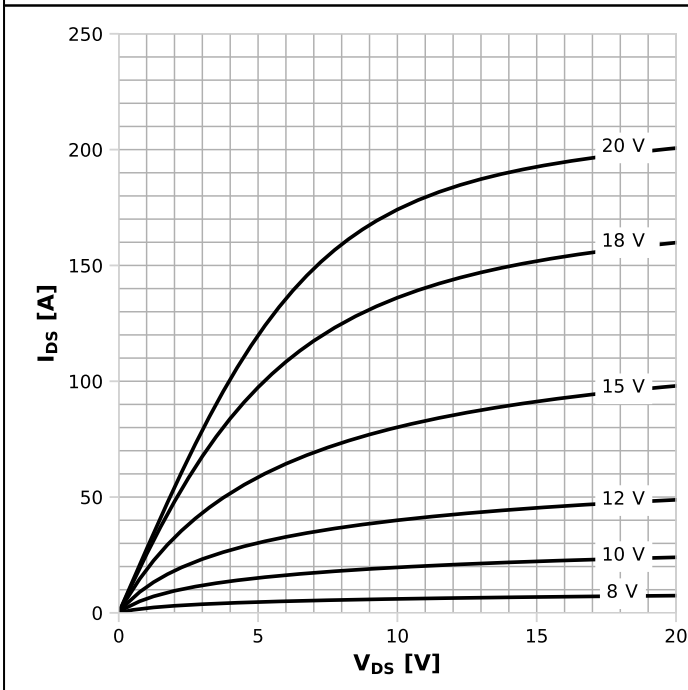

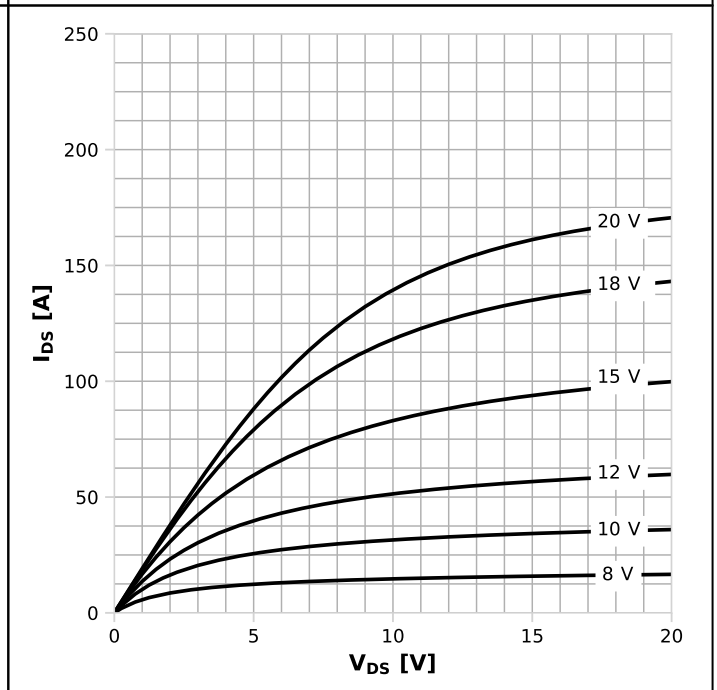

Diagram 5: Typ. output characteristics



$I_{DS}=f(V_{DS}); T_j=25\text{ °C}; \text{parameter: } V_{GS}$

Diagram 6: Typ. output characteristics



$I_{DS}=f(V_{DS}); T_j=175\text{ °C}; \text{parameter: } V_{GS}$

Diagram 7: Typ. drain-source on-state resistance

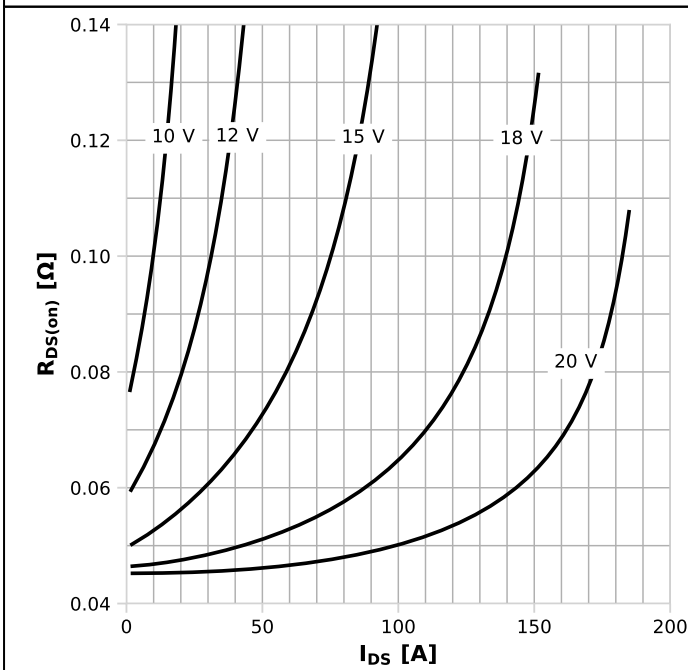

$R_{DS(on)}=f(I_{DS}); T_j=125\text{ °C}; \text{parameter: } V_{GS}$

Diagram 8: Drain-source on-state resistance

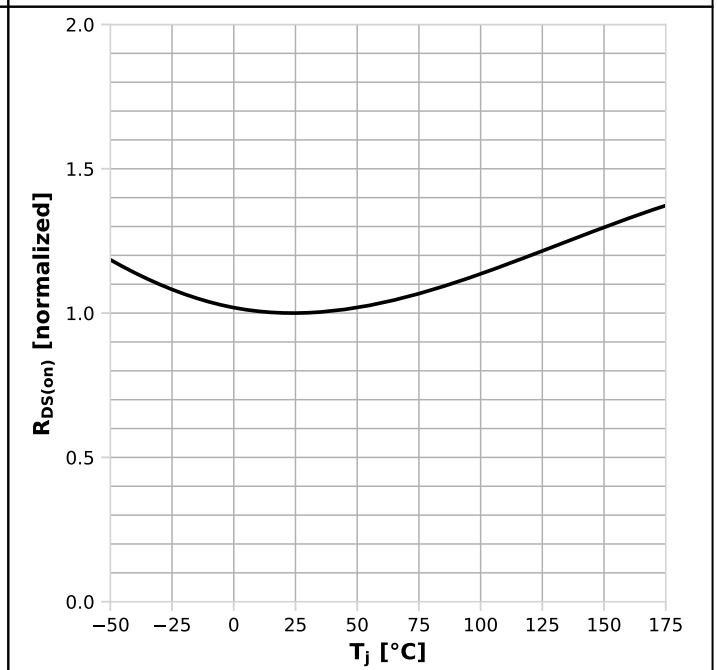

$R_{DS(on)}=f(T_j); I_D=25\text{ A}; V_{GS}=18\text{ V}$

Diagram 9: Typ. transfer characteristics

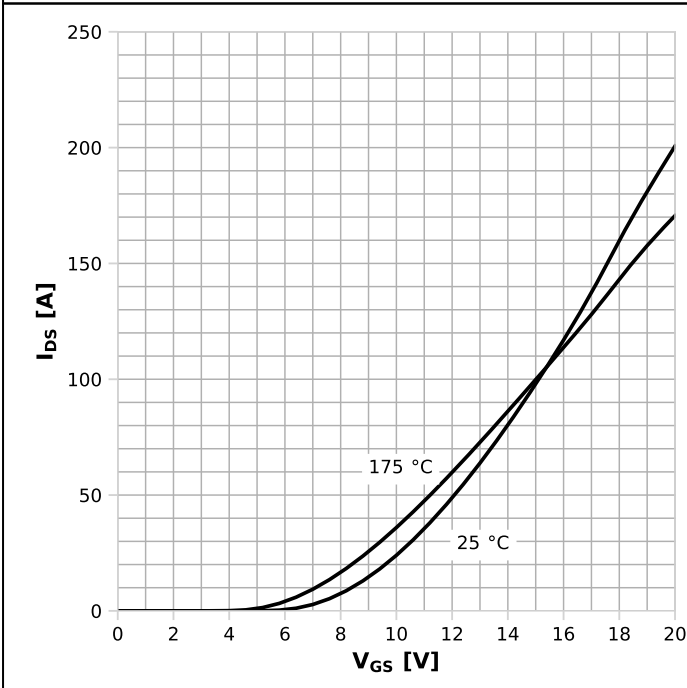

$I_{DS}=f(V_{GS}); V_{DS}=20V$ ; parameter:  $T_j$

Diagram 10: Typ. gate charge

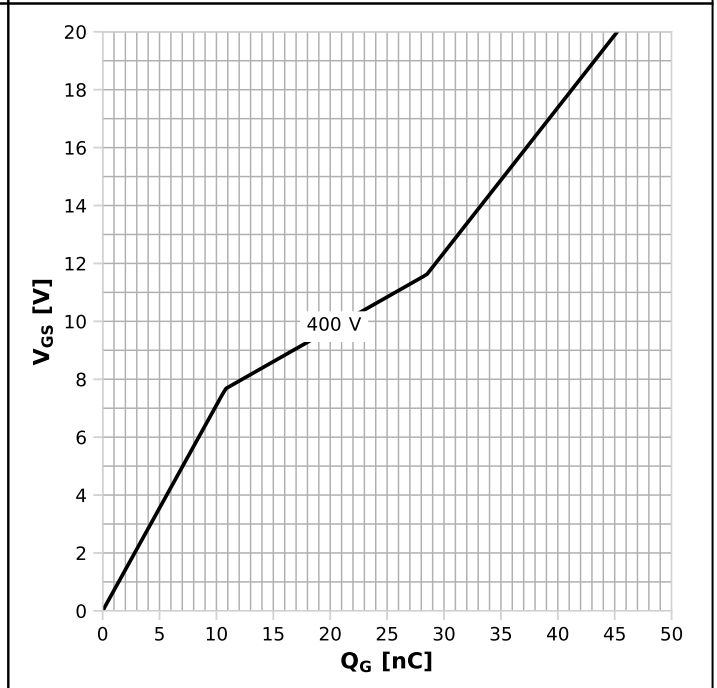

$V_{GS}=f(Q_G); I_D=25.0$  A pulsed; parameter:  $V_{DD}$

Diagram 11: Typ. reverse drain current characteristics

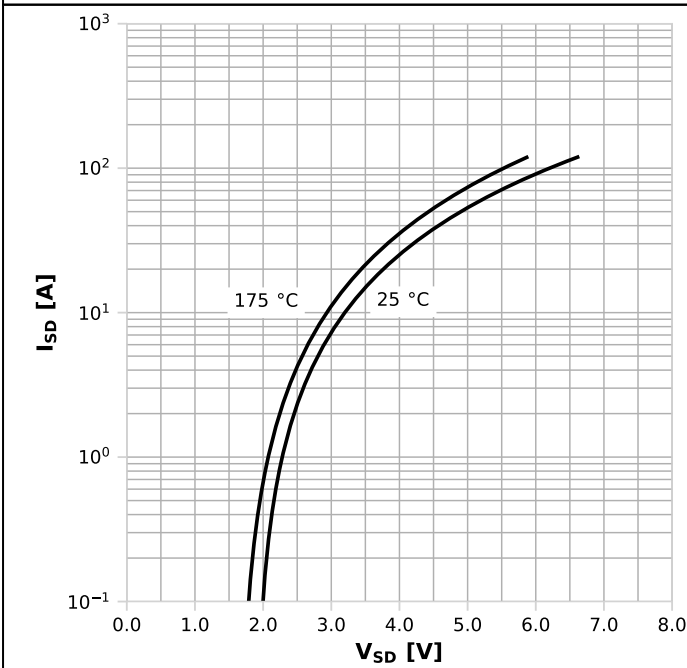

$I_{SD}=f(V_{SD}); V_{GS}=0$  V; parameter:  $T_j$

Diagram 12: Typ. reverse drain current characteristics

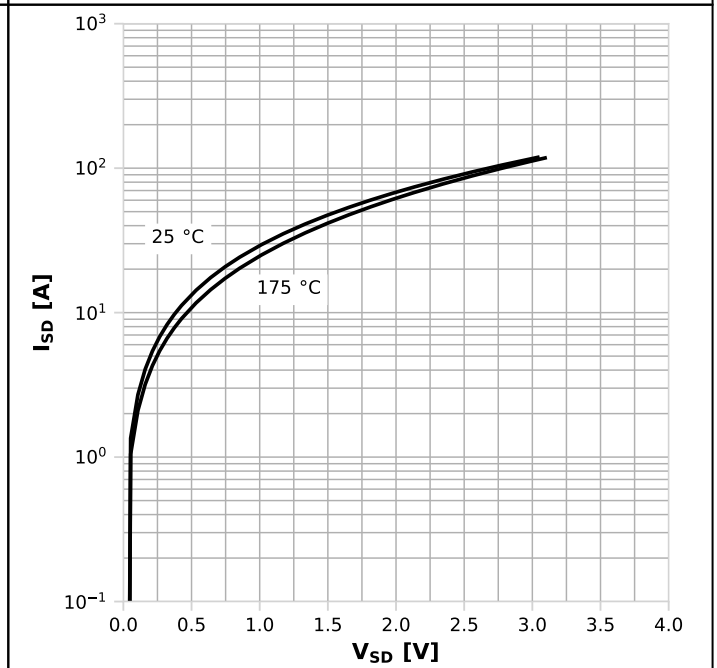

$I_{SD}=f(V_{SD}); V_{GS}=18$  V; parameter:  $T_j$

Diagram 13: Avalanche energy

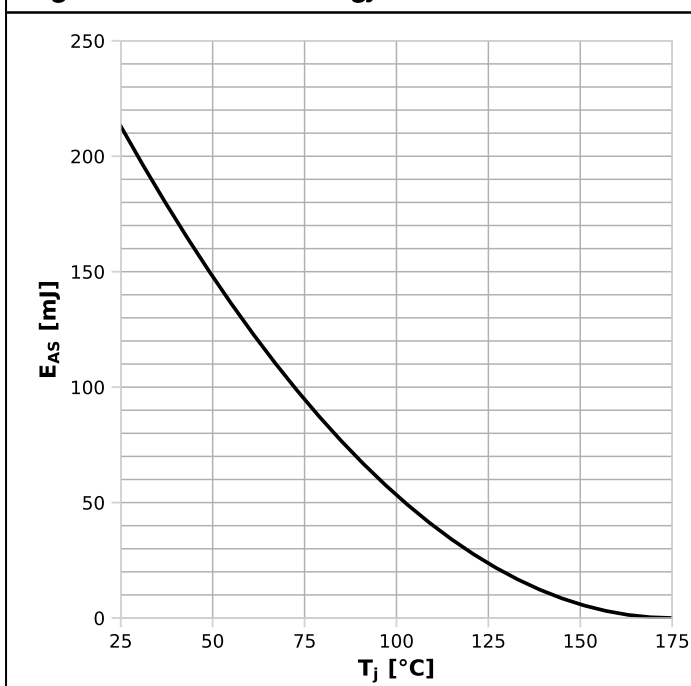

$E_{AS}=f(T_j); I_D=8.0\text{ A}; V_{DD}=50\text{ V}$

Diagram 14: Drain-source breakdown voltage

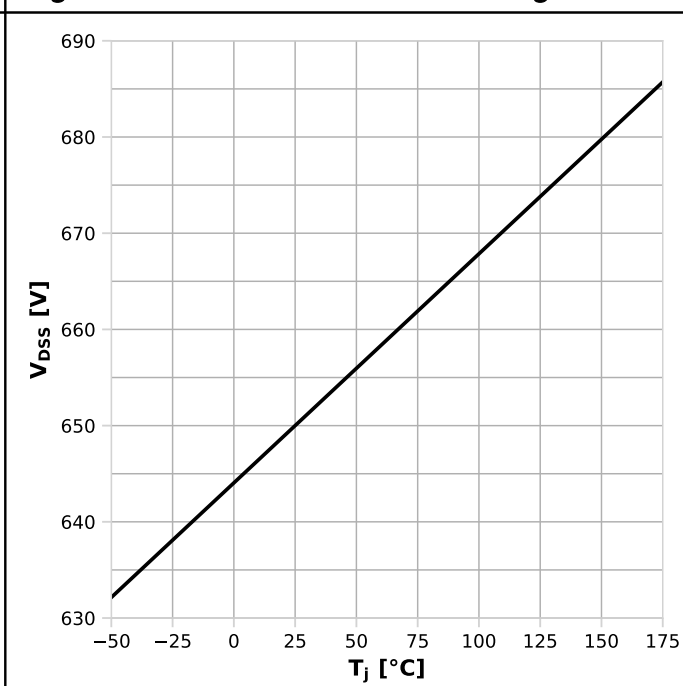

$V_{DSS}=f(T_j); I_D=0.75\text{ mA}$

Diagram 15: Typ. capacitances

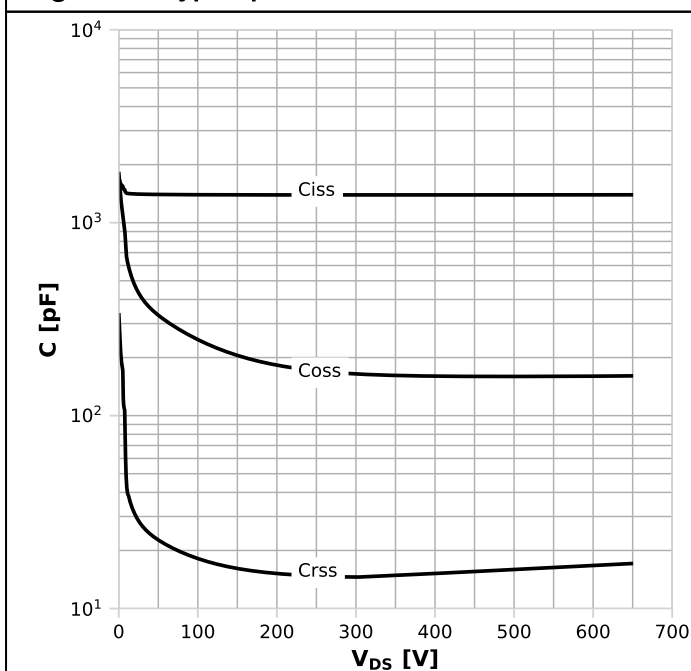

$C=f(V_{DS}); V_{GS}=0\text{ V}; f=250\text{ kHz}$

Diagram 16: Typ. Coss stored energy

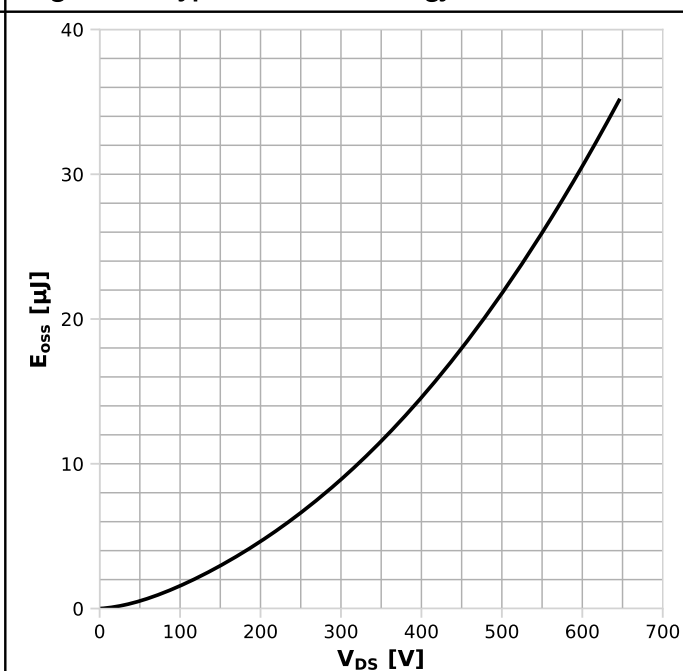

$E_{oss}=f(V_{DS})$

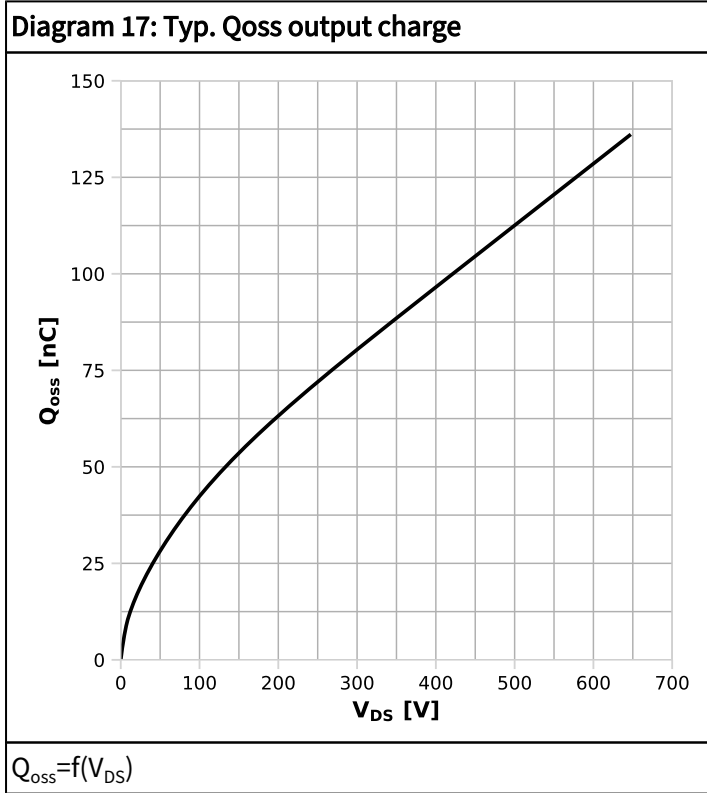

## 6 Test circuits

**Table 9 Body diode characteristics**

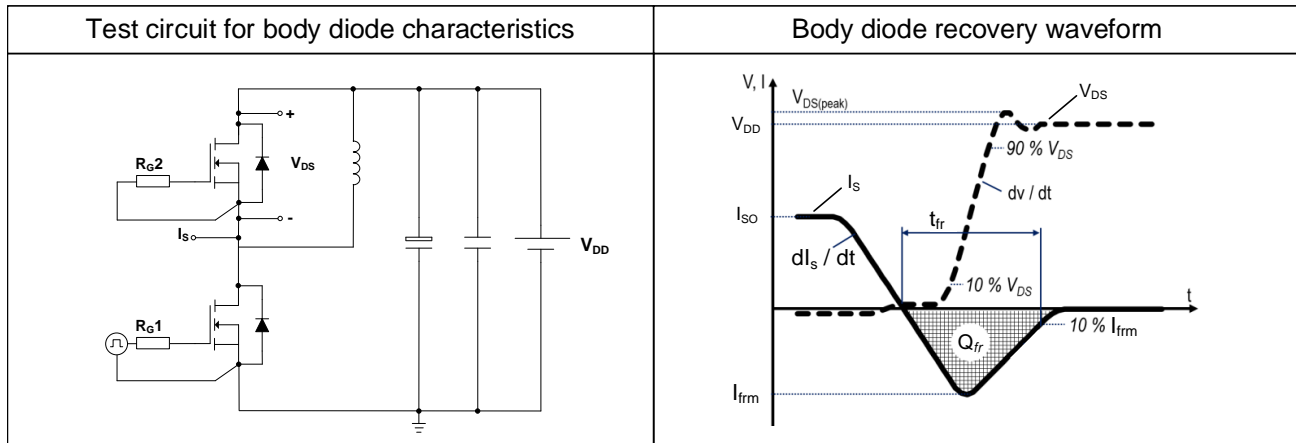

**Table 10 Switching times**

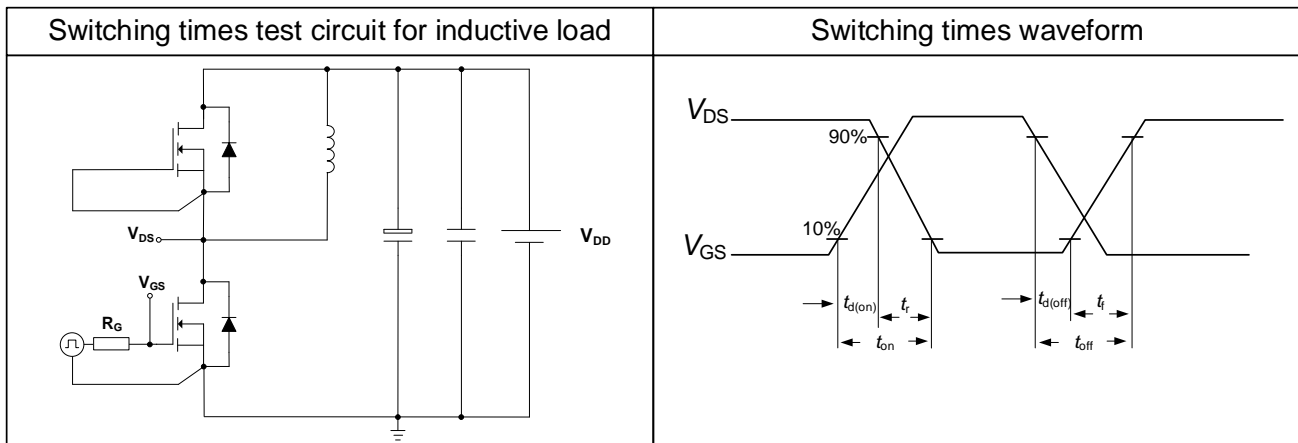

**Table 11 Unclamped inductive load**

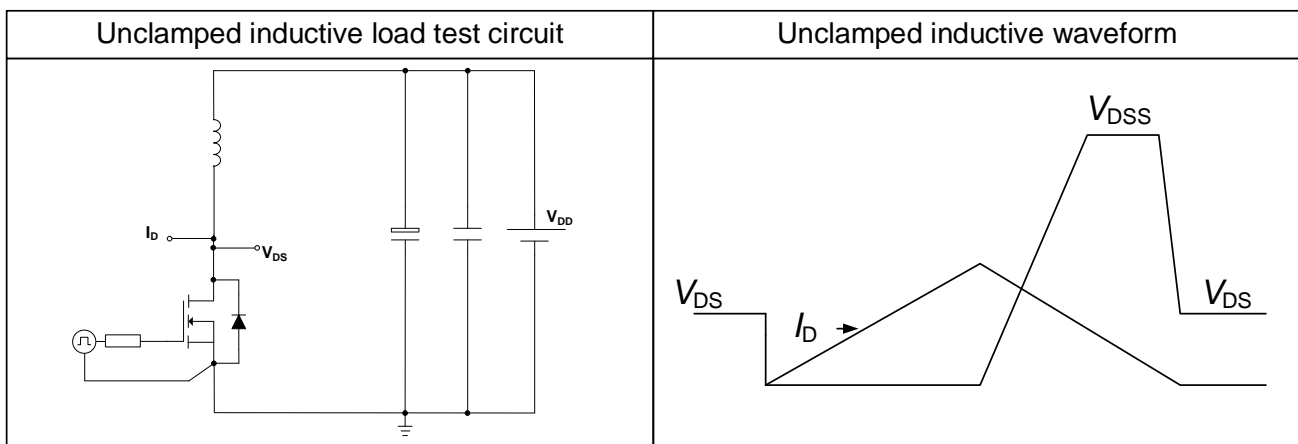

## 7 Package outlines

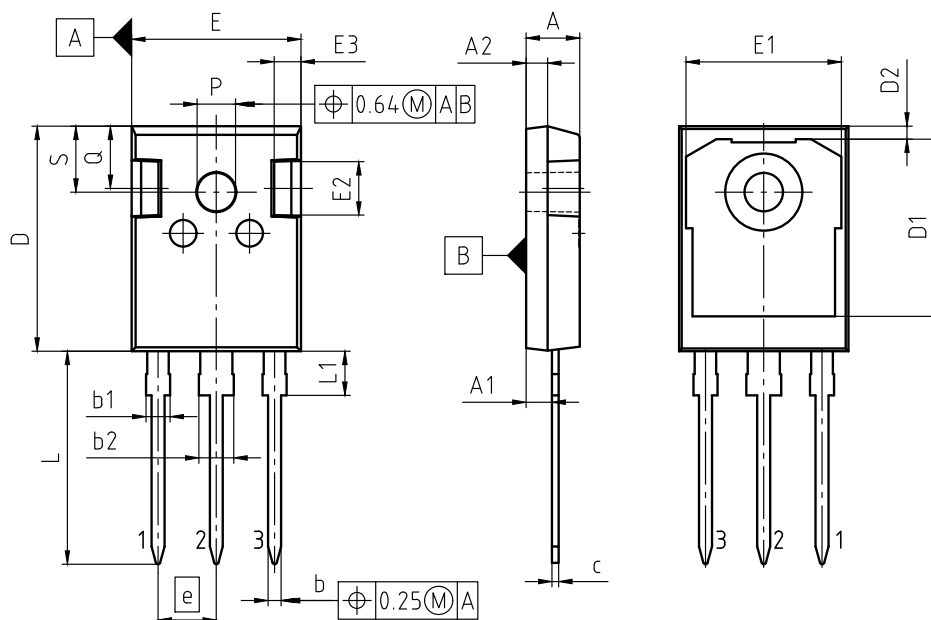

PACKAGE - GROUP NUMBER: <b>PG-T0247-3</b>		
DIMENSIONS	MILLIMETERS	
	MIN.	MAX.
A	4.70	5.30
A1	2.20	2.60
A2	1.50	2.50
b	1.00	1.40
b1	1.60	2.41
b2	2.57	3.43
c	0.38	0.89
D	20.70	21.50
D1	13.08	17.65
D2	0.51	1.35
E	15.50	16.30
E1	12.38	14.15
E2	3.40	5.10
E3	1.00	2.60
e	5.44	
N	3	
L	19.80	20.40
L1	3.85	4.50
øP	3.50	3.70
Q	5.35	6.25
S	6.04	6.30

NOTE:  
DIMENSIONS DO NOT INCLUDE MOLDFLASH; PROTRUSION OR GATE BURRS

**Figure 1** Outline PG-T0247-3, dimensions in mm

## 8 Appendix A

Table 12 Related links

- [IFX CoolSiC CoolSiC™ MOSFET 650 V G1 Webpage](#)
- [IFX CoolSiC CoolSiC™ MOSFET 650 V G1 Application Note](#)
- [IFX CoolSiC CoolSiC™ MOSFET 650 V G1 Simulation Model](#)
- [IFX Design tools](#)

## Revision history

IMW65R039M1H

### Revision 2025-01-20, Rev. 2.2

Previous revisions

Revision	Date	Subjects (major changes since last revision)
2.0	2021-03-17	Release of final version
2.1	2024-08-26	$V_{GS}$ specs update, $I_{DSS}$ update, nomenclature update, datasheet layout update.
2.2	2025-01-20	Corrected $I_s$ value in test condition of parameter $V_{sd}$ .

#### Trademarks

All referenced product or service names and trademarks are the property of their respective owners.

**We Listen to Your Comments** Any information within this document that you feel is wrong, unclear or missing at all? Your feedback will help us to continuously improve the quality of this document. Please send your proposal (including a reference to this document) to: [erratum@infineon.com](mailto:erratum@infineon.com)

#### Published by

Infineon Technologies AG  
81726 München, Germany  
© 2025 Infineon Technologies AG  
All Rights Reserved.

#### Legal Disclaimer

The information given in this document shall in no event be regarded as a guarantee of conditions or characteristics ("Beschaffheitsgarantie"). With respect to any examples, hints or any typical values stated herein and/or any information regarding the application of the product, Infineon Technologies hereby disclaims any and all warranties and liabilities of any kind, including without limitation warranties of non-infringement of intellectual property rights of any third party.

In addition, any information given in this document is subject to customer's compliance with its obligations stated in this document and any applicable legal requirements, norms and standards concerning customer's products and any use of the product of Infineon Technologies in customer's applications.

The data contained in this document is exclusively intended for technically trained staff. It is the responsibility of customer's technical departments to evaluate the suitability of the product for the intended application and the completeness of the product information given in this document with respect to such application.

#### Information

For further information on technology, delivery terms and conditions and prices please contact your nearest Infineon Technologies Office ([www.infineon.com](http://www.infineon.com)).

#### Warnings

Due to technical requirements, components may contain dangerous substances. For information on the types in question, please contact the nearest Infineon Technologies Office.

The Infineon Technologies component described in this Data Sheet may be used in life-support devices or systems and/or automotive, aviation and aerospace applications or systems only with the express written approval of Infineon Technologies, if a failure of such components can reasonably be expected to cause the failure of that life-support, automotive, aviation and aerospace device or system or to affect the safety or effectiveness of that device or system. Life support devices or systems are intended to be implanted in the human body or to support and/or maintain and sustain and/or protect human life. If they fail, it is reasonable to assume that the health of the user or other persons may be endangered.