

**TRENCHSTOP™ IGBT6 with soft, fast recovery antiparallel Rapid diode**

**Features**

- $V_{CE} = 650\text{ V}$
- $I_C = 10\text{ A}$
- Very low  $V_{CE(sat)}$  1.5 V (typ.)
- Maximum junction temperature  $T_{vjmax} = 175^\circ\text{C}$
- Short circuit withstand time 3  $\mu\text{s}$
- Very tight parameter distribution
- High ruggedness, temperature stable behavior
- Low  $V_{CE(sat)}$  and positive temperature coefficient
- Low gate charge  $Q_G$
- Pb-free lead plating; RoHS compliant
- Very soft, fast recovery antiparallel Rapid diode
- Product spectrum and PSpice Models: <http://www.infineon.com/igbt/>

**Potential applications**

- General purpose drives (GPD)
- Air conditioning
- Other major home appliances
- Other small home appliances

**Product validation**

- Qualified for industrial applications according to the relevant tests of JEDEC47/20/22

**Description**



- Lead-Free
- Green
- Halogen-Free
- RoHS

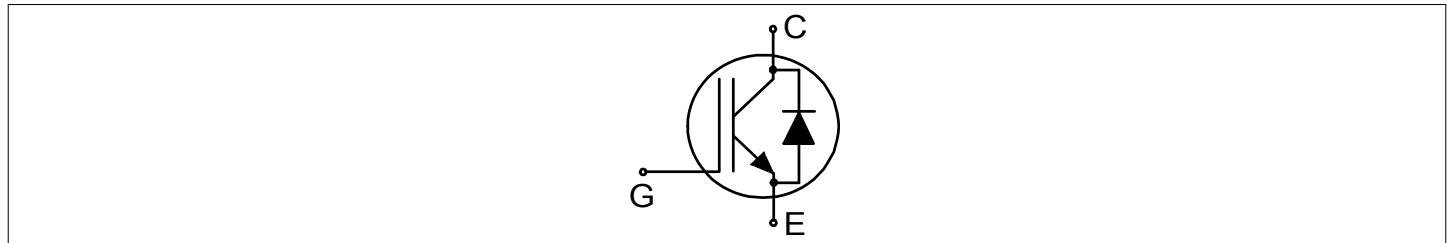

Type	Package	Marking
IKA10N65ET6	PG-TO220-3 FP	K10EET6

## Table of contents

	<b>Description</b> .....	1
	<b>Features</b> .....	1
	<b>Potential applications</b> .....	1
	<b>Product validation</b> .....	1
	<b>Table of contents</b> .....	2
<b>1</b>	<b>Package</b> .....	3
<b>2</b>	<b>IGBT</b> .....	3
<b>3</b>	<b>Diode</b> .....	5
<b>4</b>	<b>Characteristics diagrams</b> .....	7
<b>5</b>	<b>Package outlines</b> .....	14
<b>6</b>	<b>Testing conditions</b> .....	15
	<b>Revision history</b> .....	16
	<b>Disclaimer</b> .....	17

## 1 Package

**Table 1** Characteristic values

Parameter	Symbol	Note or test condition	Values			Unit
			Min.	Typ.	Max.	
Isolation test voltage RMS	$V_{isol}$	$f = +50/+60$ Hz, $t = 1$ min			2500	V
Internal emitter inductance measured 5 mm (0.197 in) from case	$L_E$			7.0		nH
Storage temperature	$T_{stg}$		-55		150	°C
Soldering temperature		wave soldering 1.6mm (0.063in.) from case for 10s			260	°C
Mounting torque, M3 screw Maximum of mounting processes: 3	$M$				0.5	Nm
Thermal resistance, junction-ambient	$R_{th(j-a)}$				65	K/W

## 2 IGBT

**Table 2** Maximum rated values

Parameter	Symbol	Note or test condition	Values	Unit	
Collector-emitter voltage	$V_{CE}$	$T_{vj} \geq 25$ °C	650	V	
DC collector current, limited by $T_{vjmax}$ <sup>1)</sup>	$I_C$		$T_h = 25$ °C	25	A
			$T_h = 100$ °C	16	
Pulsed collector current, $t_p$ limited by $T_{vjmax}$	$I_{Cpuls}$		42.5	A	
Turn-off safe operating area		$V_{CE} \leq 650$ V, $T_{vj} \leq 175$ °C	42.5	A	
Gate-emitter voltage	$V_{GE}$		±20	V	
Transient gate-emitter voltage	$V_{GE}$	$t_p \leq 10$ μs, $D < 0.010$	±30	V	
Short-circuit withstand time	$t_{SC}$	$V_{CC} \leq 360$ V, $V_{GE} = 15$ V, Allowed number of short circuits < 1000, Time between short circuits $\geq 1.0$ s, $T_{vj} = 150$ °C	3	μs	
Power dissipation	$P_{tot}$		$T_h = 25$ °C	32.5	W
			$T_h = 100$ °C	16.2	

1) Limited by maximum junction temperature. Applicable for TO220 standard package.

**Table 3** Characteristic values

Parameter	Symbol	Note or test condition	Values			Unit
			Min.	Typ.	Max.	
Collector-emitter breakdown voltage <sup>1)</sup>	$V_{BRCES}$	$I_C = 0.1 \text{ mA}, V_{GE} = 0 \text{ V}$	650			V
Collector-emitter saturation voltage	$V_{CEsat}$	$I_C = 8.5 \text{ A}, V_{GE} = 15 \text{ V}$	$T_{vj} = 25 \text{ °C}$	1.5	1.9	V
			$T_{vj} = 125 \text{ °C}$	1.65		
			$T_{vj} = 150 \text{ °C}$	1.75		
Gate-emitter threshold voltage	$V_{GEth}$	$I_C = 0.15 \text{ mA}, V_{CE} = V_{GE}$	4.8	5.6	6.4	V
Zero gate-voltage collector current	$I_{CES}$	$V_{GE} = 0 \text{ V}, V_{CE} = 650 \text{ V}$	$T_{vj} = 25 \text{ °C}$		30	$\mu\text{A}$
			$T_{vj} = 150 \text{ °C}$		360	
Gate-emitter leakage current	$I_{GES}$	$V_{CE} = 0 \text{ V}, V_{GE} = 20 \text{ V}$			100	nA
Transconductance	$g_{fs}$	$I_C = 8.5 \text{ A}, V_{CE} = 20 \text{ V}, T_{vj} \geq 25 \text{ °C}$		8.7		S
Short-circuit collector current	$I_{SC}$	$V_{CC} \leq 360 \text{ V}, V_{GE} = 15 \text{ V}, t_{SC} \leq 3 \mu\text{s}$ , Allowed number of short circuits < 1000 , Time between short circuits $\geq 1.0 \text{ s}$ , $T_{vj} = 150 \text{ °C}$		80		A
Input capacitance	$C_{ies}$	$V_{CE} = 25 \text{ V}, V_{GE} = 0 \text{ V}, f = 1000 \text{ kHz}$		790		pF
Output capacitance	$C_{oes}$	$V_{CE} = 25 \text{ V}, V_{GE} = 0 \text{ V}, f = 1000 \text{ kHz}$		41		pF
Reverse transfer capacitance	$C_{res}$	$V_{CE} = 25 \text{ V}, V_{GE} = 0 \text{ V}, f = 1000 \text{ kHz}$		12		pF
Gate charge	$Q_G$	$I_C = 8.5 \text{ A}, V_{GE} = 15 \text{ V}$		27		nC
Turn-on delay time	$t_{don}$	$V_{CE} = 400 \text{ V}, V_{GE} = 15 \text{ V}, R_{Gon} = 47.0 \Omega, R_{Goff} = 47.0 \Omega, L_\sigma = 30 \text{ nH}, C_\sigma = 150 \text{ pF}$	$T_{vj} = 25 \text{ °C}, I_C = 8.5 \text{ A}$	30		ns
			$T_{vj} = 150 \text{ °C}, I_C = 8.5 \text{ A}$	27		
Rise time (inductive load)	$t_r$	$V_{CE} = 400 \text{ V}, V_{GE} = 15 \text{ V}, R_{Gon} = 47.0 \Omega, R_{Goff} = 47.0 \Omega, L_\sigma = 30 \text{ nH}, C_\sigma = 150 \text{ pF}$	$T_{vj} = 25 \text{ °C}, I_C = 8.5 \text{ A}$	18		ns
			$T_{vj} = 150 \text{ °C}, I_C = 8.5 \text{ A}$	18		
Turn-off delay time	$t_{doff}$	$V_{CE} = 400 \text{ V}, V_{GE} = 15 \text{ V}, R_{Gon} = 47.0 \Omega, R_{Goff} = 47.0 \Omega, L_\sigma = 30 \text{ nH}, C_\sigma = 150 \text{ pF}$	$T_{vj} = 25 \text{ °C}, I_C = 8.5 \text{ A}$	106		ns
			$T_{vj} = 150 \text{ °C}, I_C = 8.5 \text{ A}$	123		
Fall time (inductive load)	$t_f$	$V_{CE} = 400 \text{ V}, V_{GE} = 15 \text{ V}, R_{Gon} = 47.0 \Omega, R_{Goff} = 47.0 \Omega, L_\sigma = 30 \text{ nH}, C_\sigma = 150 \text{ pF}$	$T_{vj} = 25 \text{ °C}, I_C = 8.5 \text{ A}$	46		ns
			$T_{vj} = 150 \text{ °C}, I_C = 8.5 \text{ A}$	72		

(table continues...)

**Table 3 (continued) Characteristic values**

Parameter	Symbol	Note or test condition	Values			Unit
			Min.	Typ.	Max.	
Turn-on energy	$E_{on}$	$V_{CE} = 400\text{ V}, V_{GE} = 15\text{ V},$ $R_{Gon} = 47.0\ \Omega,$ $R_{Goff} = 47.0\ \Omega,$ $L_{\sigma} = 30\text{ nH}, C_{\sigma} = 150\text{ pF}$	$T_{vj} = 25\text{ }^{\circ}\text{C},$ $I_C = 8.5\text{ A}$	0.2		mJ
			$T_{vj} = 150\text{ }^{\circ}\text{C},$ $I_C = 8.5\text{ A}$	0.22		
Turn-off energy	$E_{off}$	$V_{CE} = 400\text{ V}, V_{GE} = 15\text{ V},$ $R_{Gon} = 47.0\ \Omega,$ $R_{Goff} = 47.0\ \Omega,$ $L_{\sigma} = 30\text{ nH}, C_{\sigma} = 150\text{ pF}$	$T_{vj} = 25\text{ }^{\circ}\text{C},$ $I_C = 8.5\text{ A}$	0.07		mJ
			$T_{vj} = 150\text{ }^{\circ}\text{C},$ $I_C = 8.5\text{ A}$	0.13		
Total switching energy	$E_{ts}$	$V_{CE} = 400\text{ V}, V_{GE} = 15\text{ V},$ $R_{Gon} = 47.0\ \Omega,$ $R_{Goff} = 47.0\ \Omega,$ $L_{\sigma} = 30\text{ nH}, C_{\sigma} = 150\text{ pF}$	$T_{vj} = 25\text{ }^{\circ}\text{C},$ $I_C = 8.5\text{ A}$	0.27		mJ
			$T_{vj} = 150\text{ }^{\circ}\text{C},$ $I_C = 8.5\text{ A}$	0.35		
IGBT thermal resistance, junction to case	$R_{thjc}$				4.6	K/W
IGBT thermal resistance, junction to heat sink	$R_{thjh}$				4.60	K/W
Operating junction temperature	$T_{vj}$		-40		175	$^{\circ}\text{C}$

1) Measured with filter network.

Note: Electrical Characteristic, at  $T_{vj} = 25\text{ }^{\circ}\text{C}$ , unless otherwise specified.

### 3 Diode

**Table 4 Maximum rated values**

Parameter	Symbol	Note or test condition	Values	Unit	
Repetitive peak reverse voltage	$V_{RRM}$	$T_{vj} \geq 25\text{ }^{\circ}\text{C}$	650	V	
Diode forward current, limited by $T_{vjmax}$ <sup>1)</sup>	$I_F$		$T_h = 25\text{ }^{\circ}\text{C}$	19.5	A
			$T_h = 100\text{ }^{\circ}\text{C}$	11	
Diode pulsed current, limited by $T_{vjmax}$	$I_{Fpuls}$		42.5	A	

1) Limited by maximum junction temperature. Applicable for TO220 standard package.

**Table 5** Characteristic values

Parameter	Symbol	Note or test condition		Values			Unit
				Min.	Typ.	Max.	
Diode forward voltage	$V_F$	$I_F = 8.5 \text{ A}$	$T_{vj} = 25 \text{ °C}$		1.45	1.9	V
					1.43		
					1.39		
Reverse leakage current	$I_R$	$V_R = 650 \text{ V}$	$T_{vj} = 25 \text{ °C}$			30	$\mu\text{A}$
					360		
Diode reverse recovery time	$t_{rr}$	$V_R = 400 \text{ V}$	$T_{vj} = 25 \text{ °C}$ , $I_F = 8.5 \text{ A}$ , $-di_F/dt = 450 \text{ A}/\mu\text{s}$		51		ns
					92		
Diode reverse recovery charge	$Q_{rr}$	$V_R = 400 \text{ V}$	$T_{vj} = 25 \text{ °C}$ , $I_F = 8.5 \text{ A}$ , $-di_F/dt = 450 \text{ A}/\mu\text{s}$		0.206		$\mu\text{C}$
					0.455		
Diode peak reverse recovery current	$I_{rrm}$	$V_R = 400 \text{ V}$	$T_{vj} = 25 \text{ °C}$ , $I_F = 8.5 \text{ A}$ , $-di_F/dt = 450 \text{ A}/\mu\text{s}$		5.7		A
					7.8		
Diode peak rate of fall of reverse recovery current	$di_{rr}/dt$	$V_R = 400 \text{ V}$	$T_{vj} = 25 \text{ °C}$ , $I_F = 8.5 \text{ A}$ , $-di_F/dt = 450 \text{ A}/\mu\text{s}$		-440		$\text{A}/\mu\text{s}$
					-205		
Diode thermal resistance, junction to case	$R_{thjc}$					6.4	K/W
Diode thermal resistance, junction to heat sink	$R_{thjh}$					6.40	K/W
Operating junction temperature	$T_{vj}$			-40		175	$^{\circ}\text{C}$

*Note: For optimum lifetime and reliability, Infineon recommends operating conditions that do not exceed 80% of the maximum ratings stated in this datasheet.*

## 4 Characteristics diagrams

### Forward bias safe operating area, IGBT

$$I_C = f(V_{CE})$$

$$D = 0, T_{vj} \leq 175\text{ °C}, V_{GE} \geq 15\text{ V}, T_h = 25\text{ °C}$$

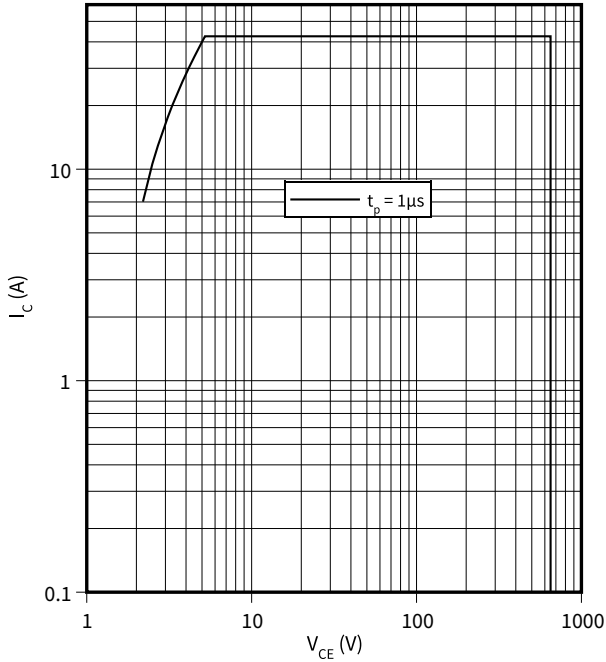

### Power dissipation as a function of case temperature, IGBT

$$P_{tot} = f(T_c)$$

$$T_{vj} \leq 175\text{ °C}$$

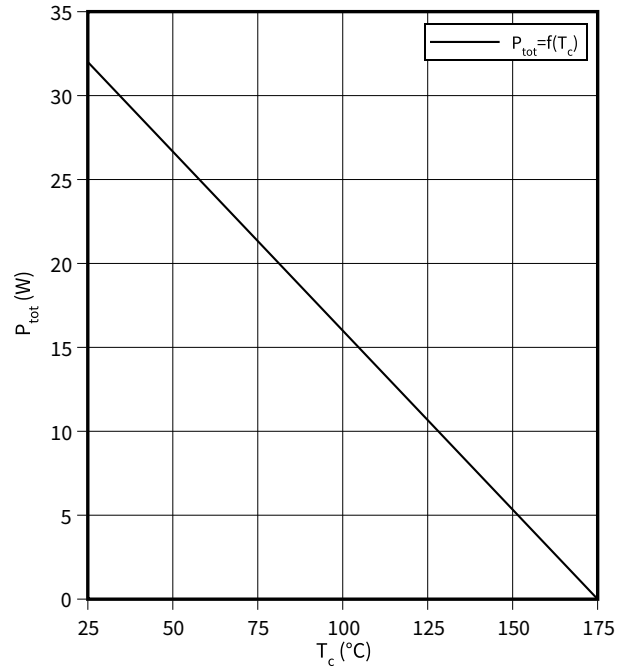

### Collector current as a function of case temperature, IGBT

$$I_C = f(T_c)$$

$$T_{vj} \leq 175\text{ °C}, V_{GE} \geq 15\text{ V}$$

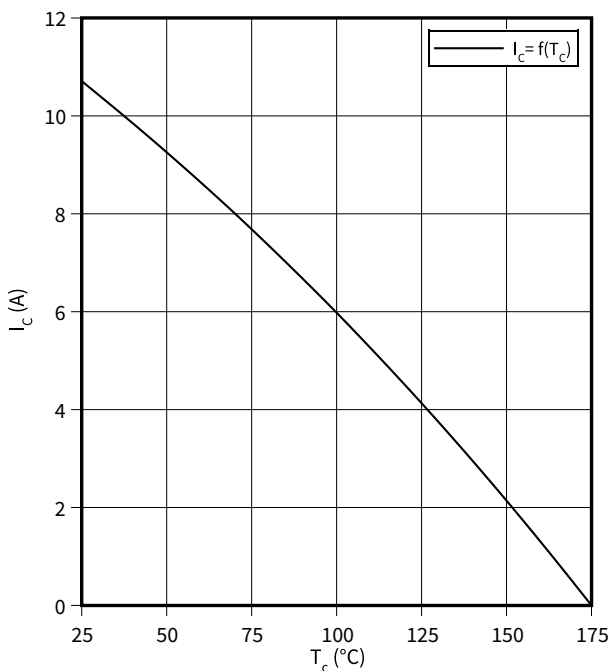

### Typical output characteristic, IGBT

$$I_C = f(V_{CE})$$

$$T_{vj} = 25\text{ °C}$$

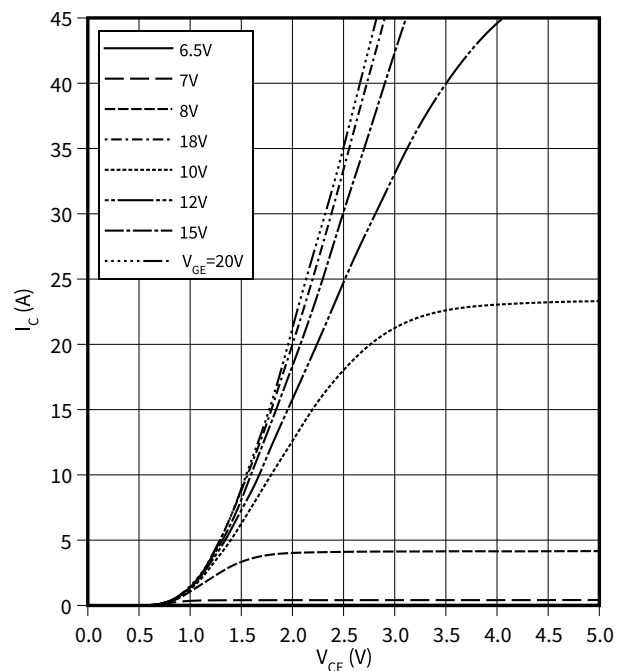

4 Characteristics diagrams

**Typical output characteristic, IGBT**

$I_C = f(V_{CE})$   
 $T_{vj} = 150\text{ °C}$

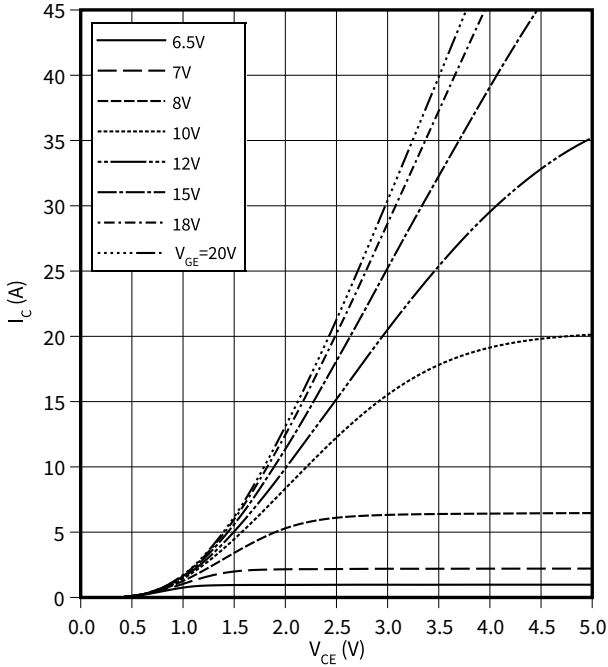

**Typical transfer characteristic, IGBT**

$I_C = f(V_{GE})$   
 $V_{CE} = 50\text{ V}$

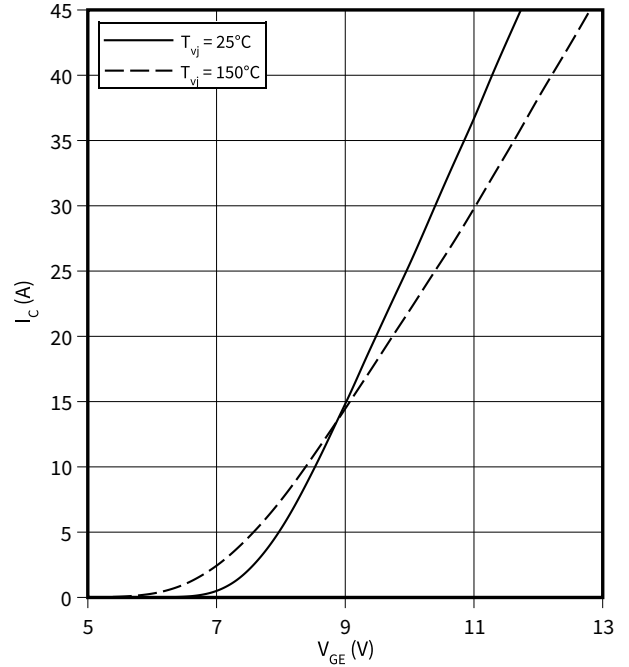

**Typical collector-emitter saturation voltage as a function of junction temperature, IGBT**

$V_{CEsat} = f(T_{vj})$   
 $V_{GE} = 15\text{ V}$

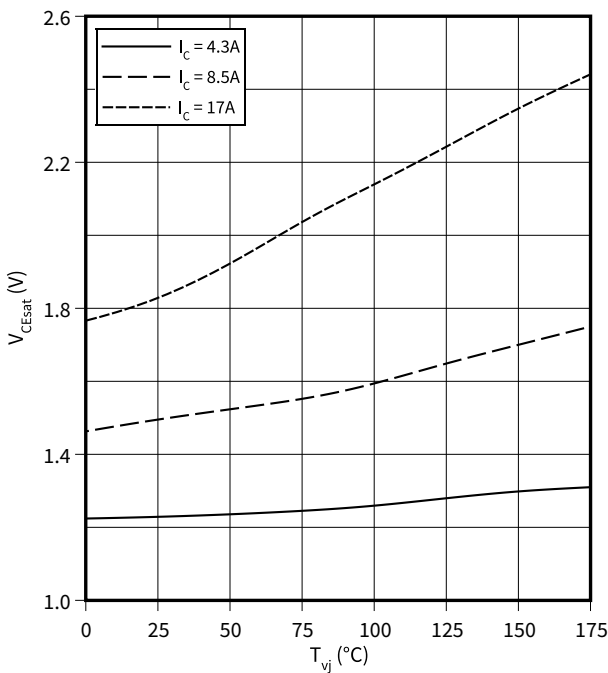

**Gate-emitter threshold voltage as a function of junction temperature, IGBT**

$V_{GEth} = f(T_{vj})$   
 $I_C = 0.15\text{ mA}$

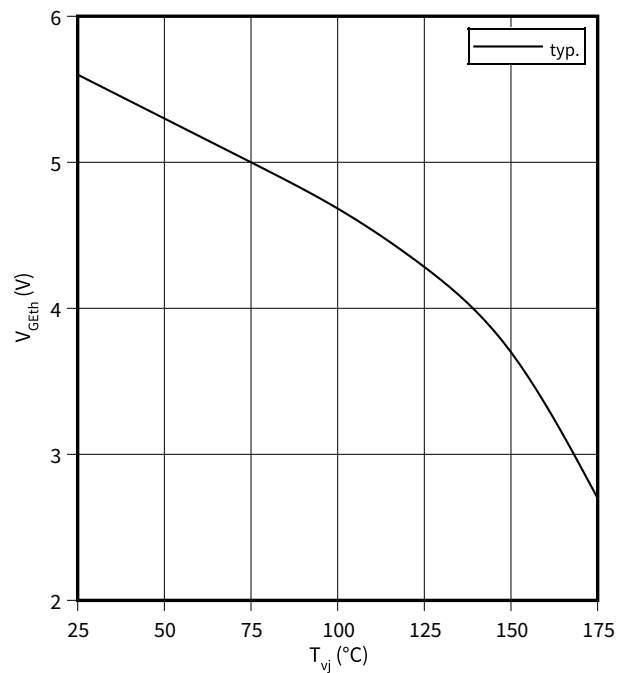



4 Characteristics diagrams

**Typical switching times as a function of collector current, IGBT**

$t = f(I_C)$

$V_{CE} = 400\text{ V}$ ,  $T_{vj} = 150\text{ °C}$ ,  $V_{GE} = 0/15\text{ V}$ ,  $R_G = 47\text{ }\Omega$

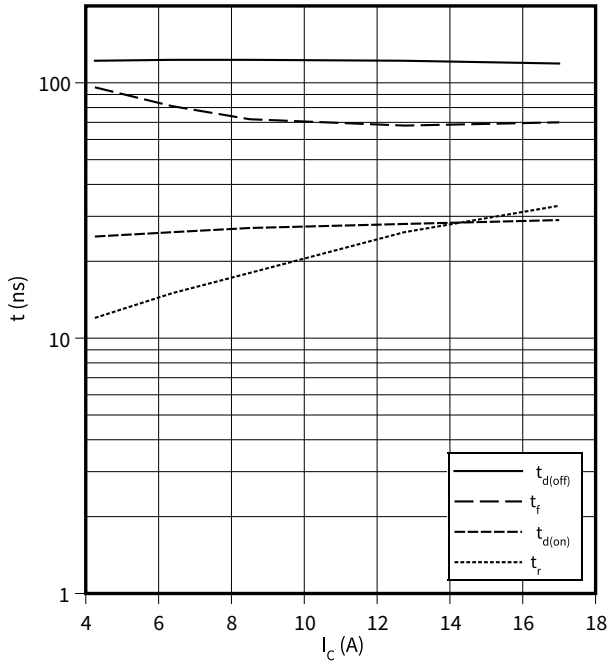

**Typical switching times as a function of gate resistor, IGBT**

$t = f(R_G)$

$I_C = 8.5\text{ A}$ ,  $V_{CE} = 400\text{ V}$ ,  $T_{vj} = 150\text{ °C}$ ,  $V_{GE} = 0/15\text{ V}$

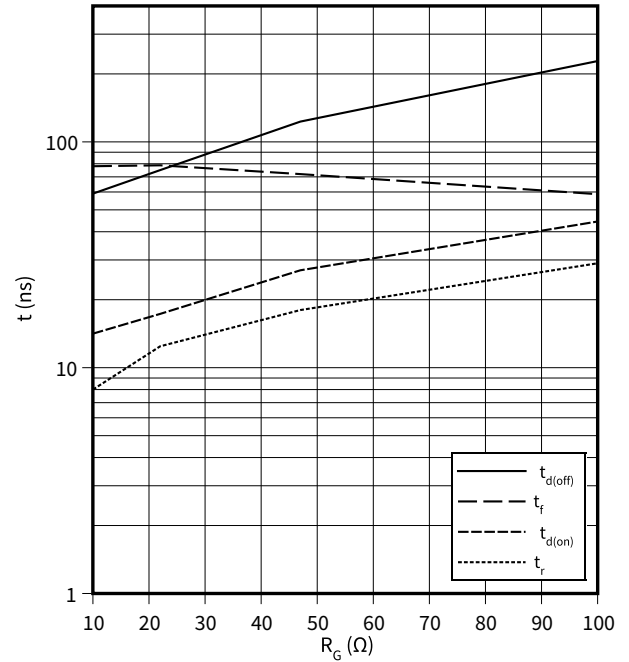

**Typical switching times as a function of junction temperature, IGBT**

$t = f(T_{vj})$

$I_C = 8.5\text{ A}$ ,  $V_{CE} = 400\text{ V}$ ,  $V_{GE} = 0/15\text{ V}$ ,  $R_G = 47\text{ }\Omega$

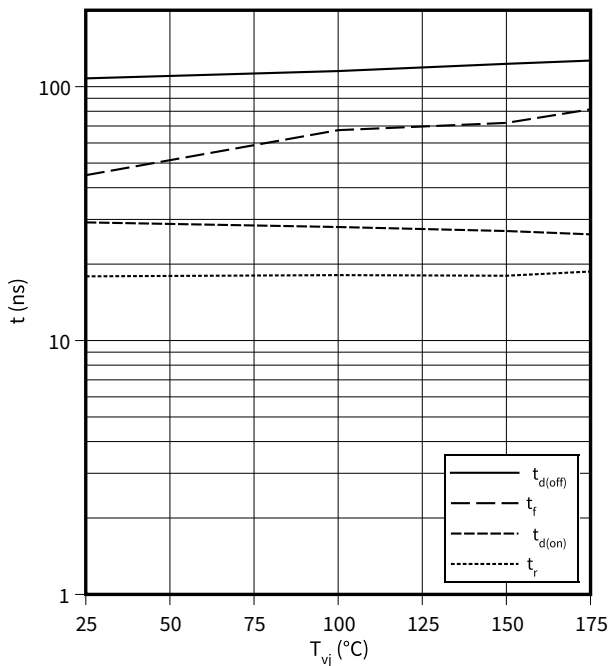

**Typical switching energy losses as a function of collector current, IGBT**

$E = f(I_C)$

$V_{CE} = 400\text{ V}$ ,  $T_{vj} = 150\text{ °C}$ ,  $V_{GE} = 0/15\text{ V}$ ,  $R_G = 47\text{ }\Omega$

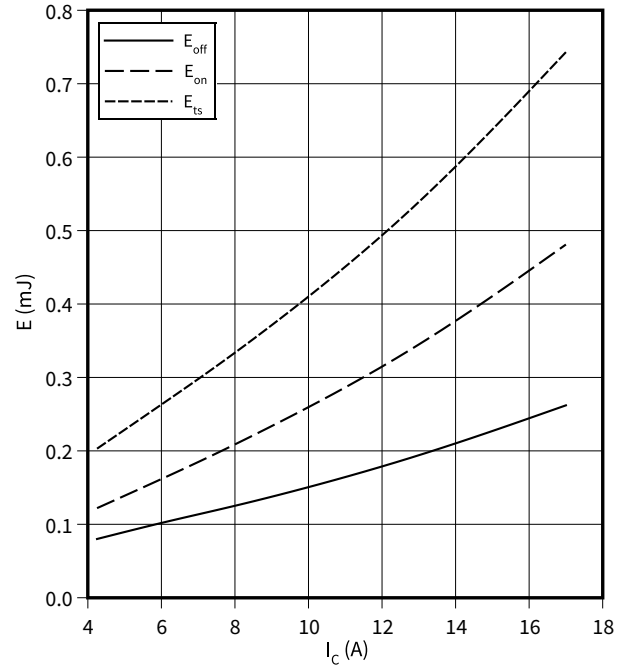

4 Characteristics diagrams

**Typical switching energy losses as a function of gate resistor, IGBT**

$E = f(R_G)$

$I_C = 8.5 \text{ A}$ ,  $V_{CE} = 400 \text{ V}$ ,  $T_{vj} = 150 \text{ °C}$ ,  $V_{GE} = 0/15 \text{ V}$

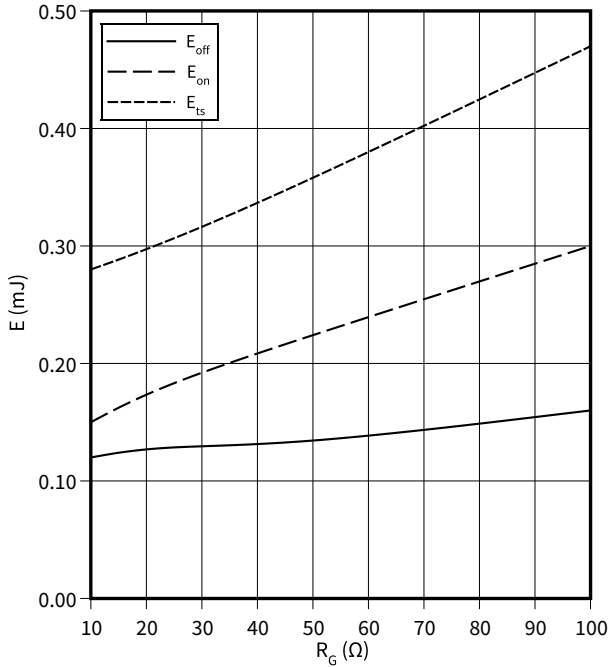

**Typical switching energy losses as a function of junction temperature, IGBT**

$E = f(T_{vj})$

$I_C = 8.5 \text{ A}$ ,  $V_{CE} = 400 \text{ V}$ ,  $V_{GE} = 0/15 \text{ V}$ ,  $R_G = 47 \text{ Ω}$

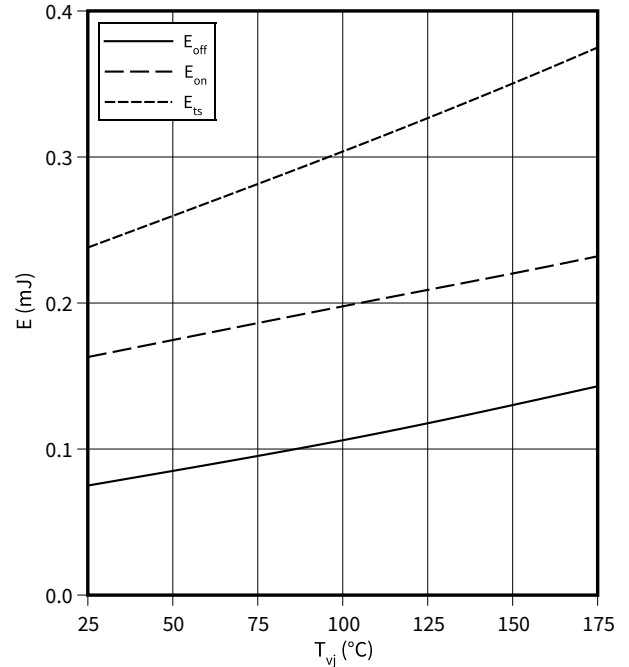

**Typical switching energy losses as a function of collector emitter voltage, IGBT**

$E = f(V_{CE})$

$I_C = 8.5 \text{ A}$ ,  $V_{GE} = 0/15 \text{ V}$ ,  $T_{vj} = 150 \text{ °C}$ ,  $R_G = 47 \text{ Ω}$

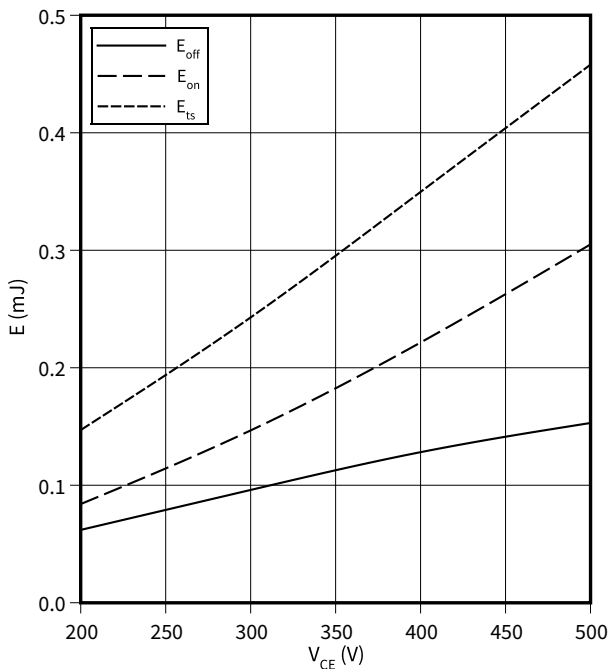

**Typical gate charge, IGBT**

$V_{GE} = f(Q_{GE})$

$I_C = 8.5 \text{ A}$

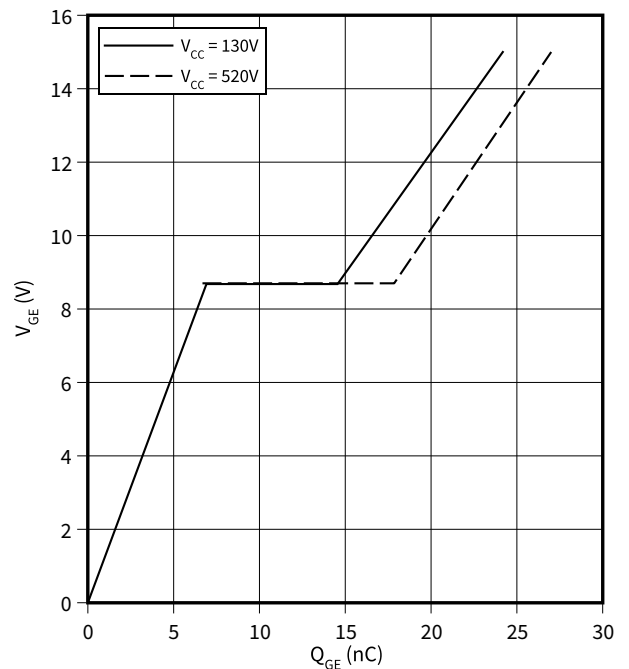

4 Characteristics diagrams

**Typical capacitance as a function of collector-emitter voltage, IGBT**

$C = f(V_{CE})$   
 $f = 1000 \text{ kHz}, V_{GE} = 0 \text{ V}$

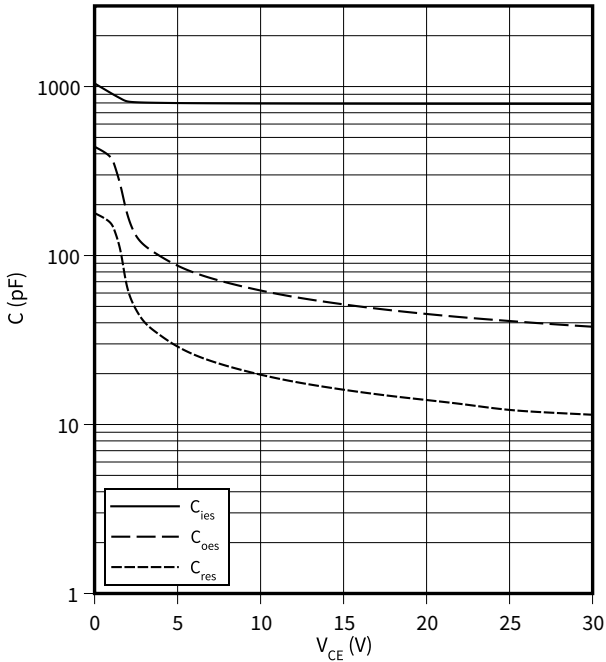

**IGBT transient thermal impedance, IGBT**

$Z_{th} = f(t_p)$   
 $D = t_p/T$

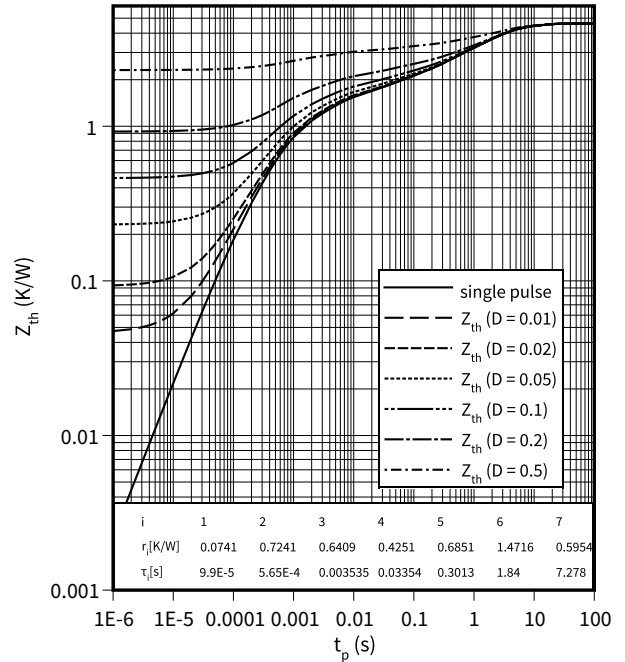

**Diode transient thermal impedance as a function of pulse width, Diode**

$Z_{th} = f(t_p)$   
 $D = t_p/T$

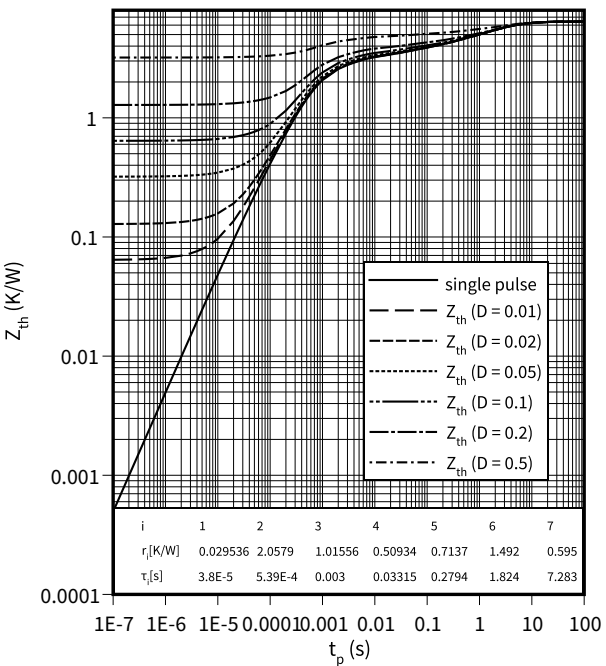

**Typical diode forward current as a function of forward voltage, Diode**

$I_F = f(V_F)$

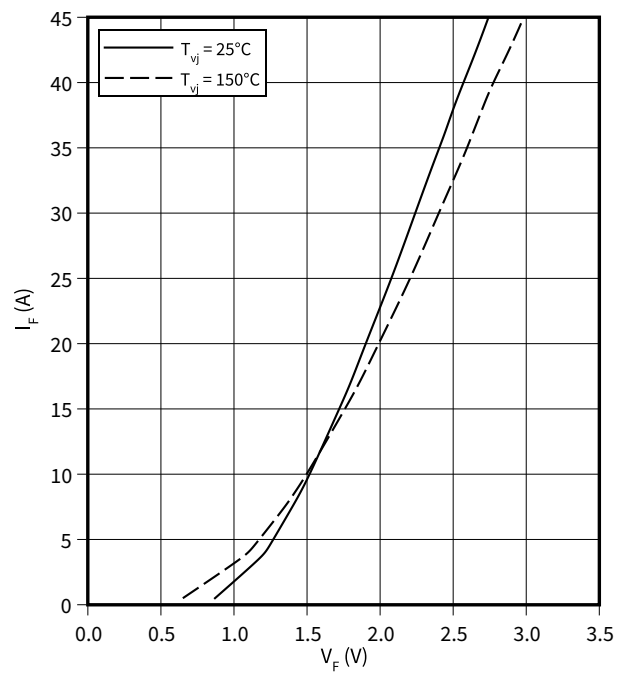

4 Characteristics diagrams

**Typical diode forward voltage as a function of junction temperature, Diode**

$V_F = f(T_{vj})$

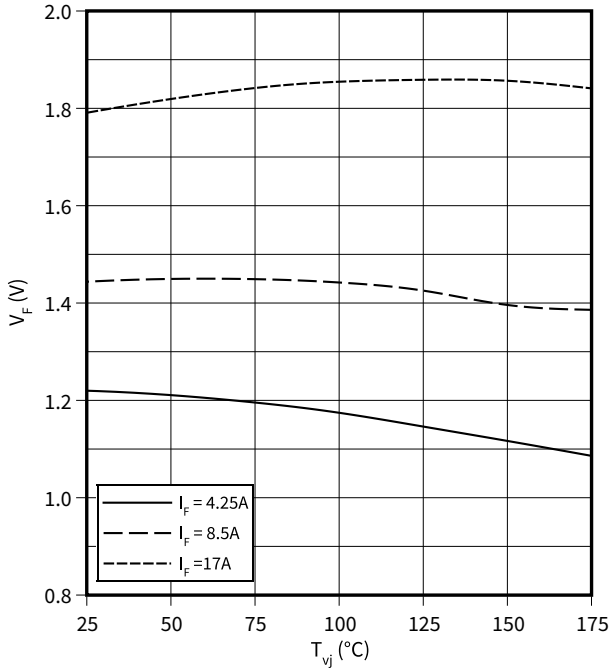

**Typical reverse recovery time as a function of diode current slope, Diode**

$t_{rr} = f(di_F/dt)$

$V_R = 400 V, I_F = 8.5 A$

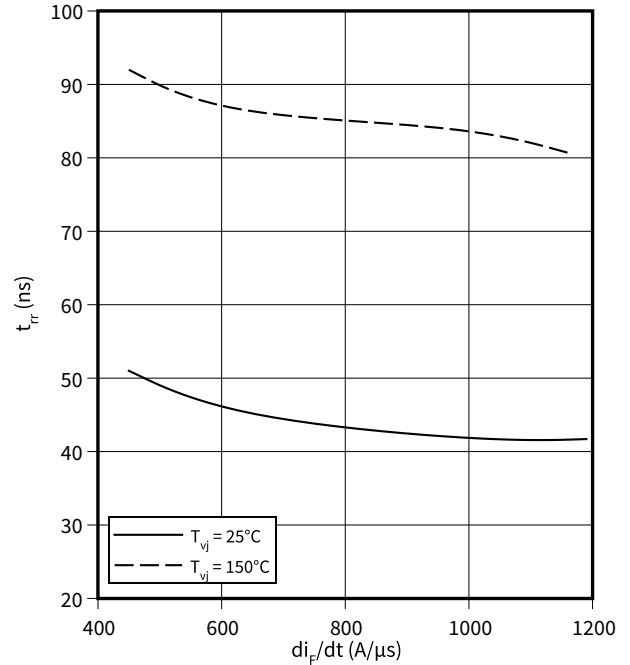

**Typical reverse recovery charge as a function of diode current slope, Diode**

$Q_{rr} = f(di_F/dt)$

$V_R = 400 V, I_F = 8.5 A$

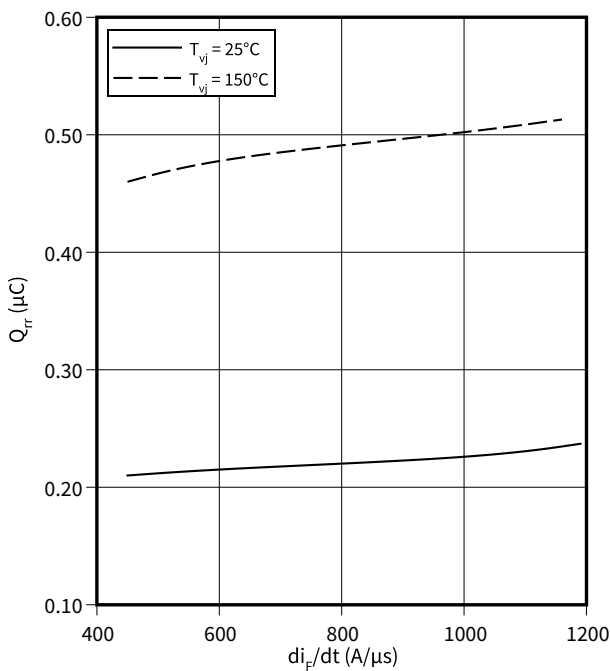

**Typical reverse recovery current as a function of diode current slope, Diode**

$I_{rr} = f(di_F/dt)$

$V_R = 400 V, I_F = 8.5 A$

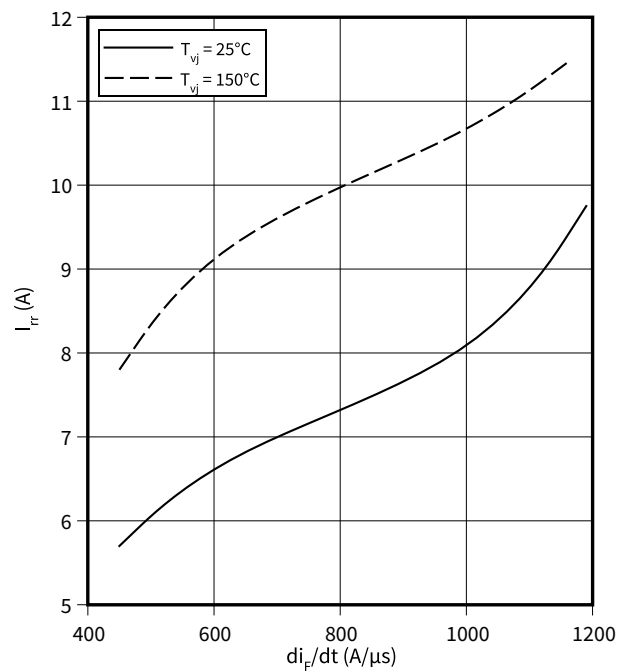

**Typical diode peak rate of fall of reverse recovery current as a function of diode current slope, Diode**

$$di_{rr}/dt = f(di_F/dt)$$

$V_R = 400\text{ V}$ ,  $I_F = 8.5\text{ A}$

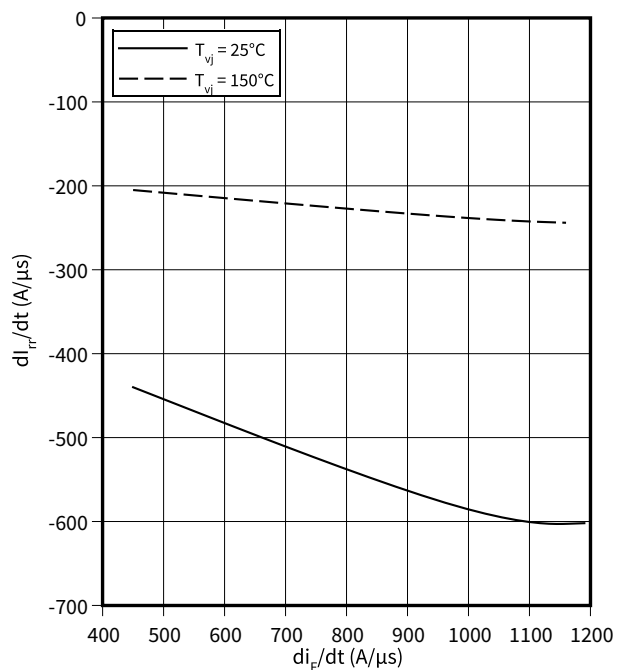

5 Package outlines

Package Drawing PG-TO220-3-FP

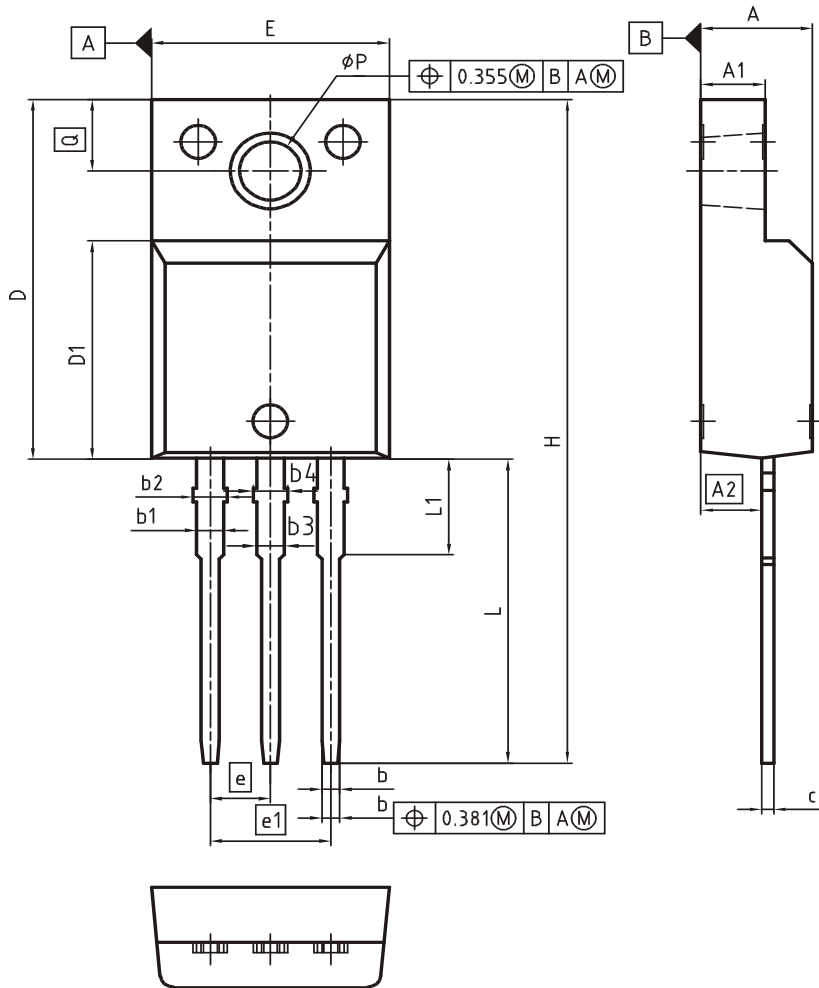

DIM	MILLIMETERS		INCHES	
	MIN	MAX	MIN	MAX
A	4.55	4.85	0.179	0.191
A1	2.55	2.85	0.100	0.112
A2	2.42	2.72	0.095	0.107
b	0.65	0.85	0.026	0.033
b1	0.95	1.33	0.037	0.052
b2	0.95	1.51	0.037	0.059
b3	0.65	1.33	0.026	0.052
b4	0.65	1.51	0.026	0.059
c	0.40	0.63	0.016	0.025
D	15.85	16.15	0.624	0.636
D1	9.53	9.83	0.375	0.387
E	10.35	10.65	0.407	0.419
e	2.54		0.100	
e1	5.08		0.200	
N	3		3	
H	29.45	29.75	1.159	1.171
L	13.45	13.75	0.530	0.541
L1	3.15	3.45	0.124	0.136
øP	2.95	3.20	0.116	0.126
Q	3.15	3.50	0.124	0.138

DOCUMENT NO.  
Z8B00003319

SCALE

EUROPEAN PROJECTION

ISSUE DATE  
08-03-2007

REVISION  
03

Figure 1

## 6 Testing conditions

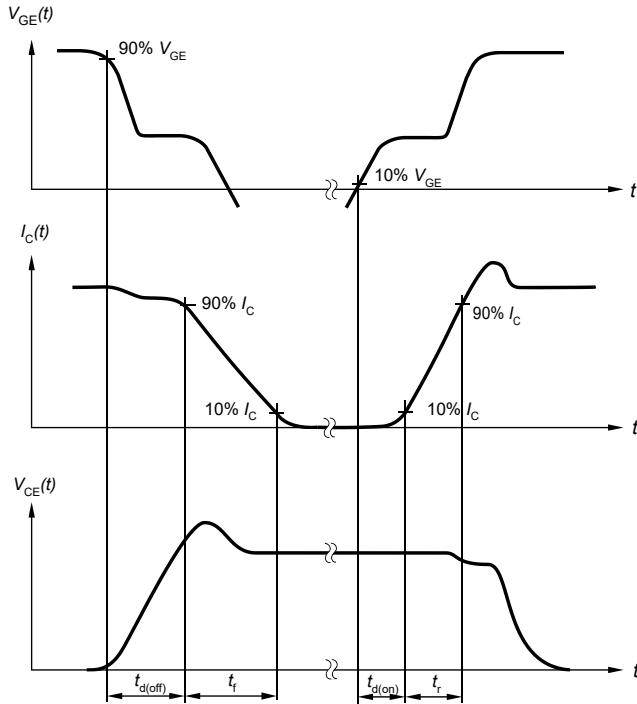

Figure A. Definition of switching times

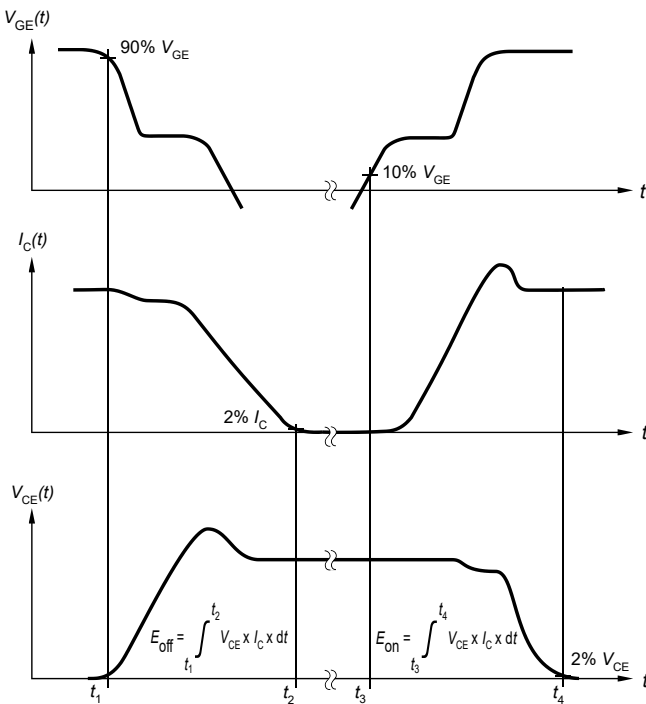

Figure B. Definition of switching losses

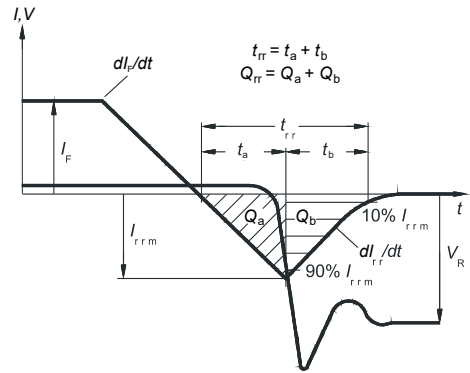

Figure C. Definition of diode switching characteristics

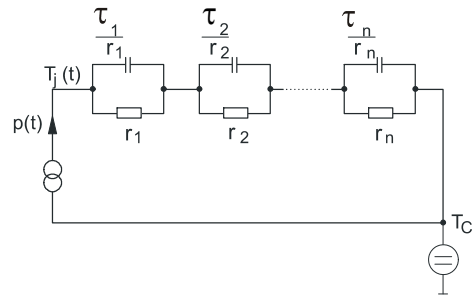

Figure D. Thermal equivalent circuit

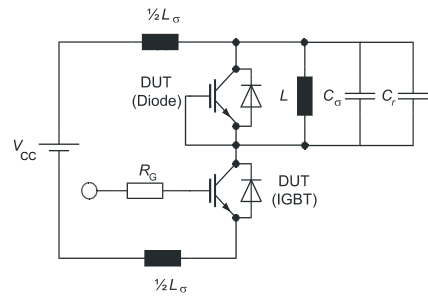

Figure E. Dynamic test circuit  
Parasitic inductance  $L_{\sigma}$ ,  
parasitic capacitor  $C_{\sigma}$ ,  
relief capacitor  $C_r$ ,  
(only for ZVT switching)

Figure 2

## Revision history

Document revision	Date of release	Description of changes
V2.1	2017-09-11	Final Datasheet
V2.2	2017-11-30	New Gfs Value at VCE=20V
V2.3	2019-09-13	Change of Rth/Zth values and maximum DC ratings
1.00	2021-10-18	Change of unit in thermal impedance figures



## Trademarks

All referenced product or service names and trademarks are the property of their respective owners.

**Edition 2021-10-18**

**Published by**

**Infineon Technologies AG**

**81726 Munich, Germany**

**© 2021 Infineon Technologies AG**

**All Rights Reserved.**

**Do you have a question about any aspect of this document?**

**Email: [erratum@infineon.com](mailto:erratum@infineon.com)**

**Document reference**

**IFX-AAL160-004**

## IMPORTANT NOTICE

The information given in this document shall in no event be regarded as a guarantee of conditions or characteristics ("Beschaffheitsgarantie").

With respect to any examples, hints or any typical values stated herein and/or any information regarding the application of the product, Infineon Technologies hereby disclaims any and all warranties and liabilities of any kind, including without limitation warranties of non-infringement of intellectual property rights of any third party.

In addition, any information given in this document is subject to customer's compliance with its obligations stated in this document and any applicable legal requirements, norms and standards concerning customer's products and any use of the product of Infineon Technologies in customer's applications.

The data contained in this document is exclusively intended for technically trained staff. It is the responsibility of customer's technical departments to evaluate the suitability of the product for the intended application and the completeness of the product information given in this document with respect to such application.

Please note that this product is not qualified according to the AEC Q100 or AEC Q101 documents of the Automotive Electronics Council.

## WARNINGS

Due to technical requirements products may contain dangerous substances. For information on the types in question please contact your nearest Infineon Technologies office.

Except as otherwise explicitly approved by Infineon Technologies in a written document signed by authorized representatives of Infineon Technologies, Infineon Technologies' products may not be used in any applications where a failure of the product or any consequences of the use thereof can reasonably be expected to result in personal injury.