

Reverse-Conducting IGBT with monolithic body diode

Features

- $V_{CE} = 1100\text{ V}$
- $I_C = 30\text{ A}$
- Powerful monolithic body diode with low forward voltage designed for soft commutation only
- Very tight parameter distribution
- High ruggedness, temperature stable behavior
- Very low V_{CEsat}
- Easy parallel switching capability due to positive temperature coefficient in V_{CEsat}
- Low EMI
- Pb-free lead plating; RoHS compliant
- Complete product spectrum and PSpice Models: <http://www.infineon.com/igbt/>

Potential applications

- Induction cooker
- Microwave ovens
- Rice Cookers

Product validation

- Qualified for industrial applications according to the relevant tests of JEDEC47/20/22

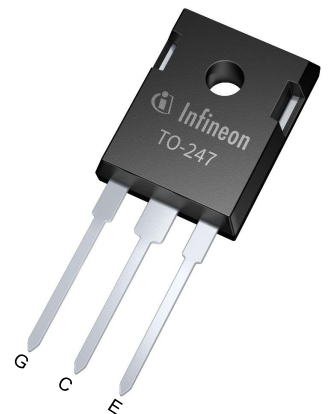

Description

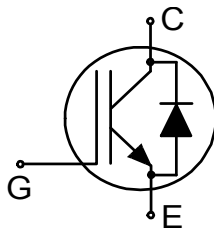

Type	Package	Marking
IHW30N110R5	PG-TO247-3-STD-NN2.5	H30KR5

Table of contents

	Description	1
	Features	1
	Potential applications	1
	Product validation	1
	Table of contents	2
1	Package	3
2	IGBT	3
3	Diode	5
4	Characteristics diagrams	6
5	Package outlines	12
6	Testing conditions	13
	Revision history	14
	Disclaimer	15

1 Package

Table 1 Characteristic values

Parameter	Symbol	Note or test condition	Values			Unit
			Min.	Typ.	Max.	
Internal emitter inductance measured 5 mm (0.197 in.) from case	L_E			13		nH
Storage temperature	T_{stg}		-55		150	°C
Soldering temperature	T_{sold}	wave soldering 1.6 mm (0.063 in.) from case for 10 s			260	°C
Mounting torque	M	M3 screw, Maximum of mounting processes: 3			0.6	Nm
Thermal resistance, junction-ambient	$R_{th(j-a)}$				40	K/W
Diode thermal resistance, junction-case	$R_{th(j-c)}$				0.45	K/W
MOSFET/body diode thermal resistance, junction-case	$R_{th(j-c)}$				0.45	K/W

2 IGBT

Table 2 Maximum rated values

Parameter	Symbol	Note or test condition	Values	Unit
Collector-emitter voltage	V_{CE}	$T_{vj} \geq 25\text{ °C}$	1100	V
DC collector current, limited by T_{vjmax}	I_C	$T_c = 25\text{ °C}$	60	A
		$T_c = 100\text{ °C}$	30	
Pulsed collector current, t_p limited by T_{vjmax}	I_{Cpulse}		90	A
Non repetitive peak collector current ¹⁾	I_{CSM}		200	A
Turn-off safe operating area		$V_{CE} \leq 1100\text{ V}$, $t_p \leq 1\text{ }\mu\text{s}$, $T_{vj} \leq 175\text{ °C}$	90	A
Gate-emitter voltage	V_{GE}		-20/25	V
Transient gate-emitter voltage	V_{GE}	$t_p \leq 10\text{ }\mu\text{s}$, $D < 0.01$	30	V
Power dissipation	P_{tot}	$T_c = 25\text{ °C}$	330	W
		$T_c = 100\text{ °C}$	165	

1) capacitor charging saturation current limited by $T_{vjmax} < 175\text{ °C}$ and $t_p < 3\text{ }\mu\text{s}$

Table 3 Characteristic values

Parameter	Symbol	Note or test condition	Values			Unit
			Min.	Typ.	Max.	
Collector-emitter breakdown voltage	V_{BRCES}	$I_C = 0.5 \text{ mA}, V_{GE} = 0 \text{ V}$	1100			V
Collector-emitter saturation voltage	V_{CEsat}	$I_C = 30 \text{ A}, V_{GE} = 15 \text{ V}$	$T_{vj} = 25 \text{ }^\circ\text{C}$	1.55	1.85	V
			$T_{vj} = 125 \text{ }^\circ\text{C}$	1.8		
			$T_{vj} = 175 \text{ }^\circ\text{C}$	1.9		
Gate-emitter threshold voltage	V_{GEth}	$I_C = 0.75 \text{ mA}, V_{CE} = V_{GE}$	5.1	5.8	6.4	V
Zero gate-voltage collector current	I_{CES}	$V_{CE} = 1100 \text{ V}, V_{GE} = 0 \text{ V}$	$T_{vj} = 25 \text{ }^\circ\text{C}$		100	μA
			$T_{vj} = 175 \text{ }^\circ\text{C}$		630	
Gate-emitter leakage current	I_{GES}	$V_{CE} = 0 \text{ V}, V_{GE} = 20 \text{ V}$			100	nA
Transconductance	g_{fs}	$I_C = 30 \text{ A}, V_{CE} = 20 \text{ V}$		23		S
Input capacitance	C_{ies}	$V_{CE} = 25 \text{ V}, V_{GE} = 0 \text{ V}, f = 100 \text{ kHz}$		1800		pF
Output capacitance	C_{oes}	$V_{CE} = 25 \text{ V}, V_{GE} = 0 \text{ V}, f = 100 \text{ kHz}$		55		pF
Reverse transfer capacitance	C_{res}	$V_{CE} = 25 \text{ V}, V_{GE} = 0 \text{ V}, f = 100 \text{ kHz}$		45		pF
Gate charge	Q_G	$V_{CC} = 880 \text{ V}, I_C = 30 \text{ A}, V_{GE} = 15 \text{ V}$		240		nC
Turn-off delay time	$t_{d(off)}$	$V_{CC} = 600 \text{ V}, V_{GE} = 0/15 \text{ V}, R_{G(on)} = 10 \text{ } \Omega, R_{G(off)} = 10 \text{ } \Omega, L_\sigma = 175 \text{ nH}, C_\sigma = 40 \text{ pF}$	$T_{vj} = 25 \text{ }^\circ\text{C}, I_C = 30 \text{ A}$	350		ns
			$T_{vj} = 175 \text{ }^\circ\text{C}, I_C = 30 \text{ A}$	400		
Fall time (inductive load)	t_f	$V_{CC} = 600 \text{ V}, V_{GE} = 0/15 \text{ V}, R_{G(on)} = 10 \text{ } \Omega, R_{G(off)} = 10 \text{ } \Omega, L_\sigma = 175 \text{ nH}, C_\sigma = 40 \text{ pF}$	$T_{vj} = 25 \text{ }^\circ\text{C}, I_C = 30 \text{ A}$	30		ns
			$T_{vj} = 175 \text{ }^\circ\text{C}, I_C = 30 \text{ A}$	120		
Turn-off energy	E_{off}	$V_{CC} = 600 \text{ V}, V_{GE} = 0/15 \text{ V}, R_{G(on)} = 10 \text{ } \Omega, R_{G(off)} = 10 \text{ } \Omega, L_\sigma = 175 \text{ nH}, C_\sigma = 40 \text{ pF}$	$T_{vj} = 25 \text{ }^\circ\text{C}, I_C = 30 \text{ A}$	1.2		mJ
			$T_{vj} = 175 \text{ }^\circ\text{C}, I_C = 30 \text{ A}$	2.4		
Soft turn-off energy	E_{off}	$V_{GE} = 0/15 \text{ V}, R_{G(on)} = 10 \text{ } \Omega, R_{G(off)} = 10 \text{ } \Omega, L_\sigma = 175 \text{ nH}, C_\sigma = 40 \text{ pF}, C_r = 270 \text{ nF}$	$T_{vj} = 25 \text{ }^\circ\text{C}, I_C = 30 \text{ A}$	0.205		mJ
			$T_{vj} = 175 \text{ }^\circ\text{C}, I_C = 30 \text{ A}$	0.49		
Operating junction temperature	T_{vj}		-40		175	$^\circ\text{C}$

Note: Electrical Characteristic, at $T_{vj} = 25 \text{ }^\circ\text{C}$, unless otherwise specified.

3 Diode

Table 4 Maximum rated values

Parameter	Symbol	Note or test condition	Values	Unit	
Repetitive peak reverse voltage	V_{RRM}	$T_{vj} \geq 25\text{ °C}$	1100	V	
Diode forward current, limited by T_{vjmax}	I_F		$T_c = 25\text{ °C}$	60	A
			$T_c = 100\text{ °C}$	30	
Diode pulsed current, t_p limited by T_{vjmax}	I_{Fpulse}		90	A	

Table 5 Characteristic values

Parameter	Symbol	Note or test condition	Values			Unit
			Min.	Typ.	Max.	
Diode forward voltage	V_F	$I_F = 30\text{ A}$	$T_{vj} = 25\text{ °C}$	1.8	2	V
			$T_{vj} = 125\text{ °C}$	2		
			$T_{vj} = 175\text{ °C}$	2.1		
Reverse leakage current	I_R	$V_R = 1100\text{ V}$	$T_{vj} = 25\text{ °C}$		100	μA
			$T_{vj} = 175\text{ °C}$		630	
Operating junction temperature	T_{vj}		-40		175	$^{\circ}\text{C}$

Note: For optimum lifetime and reliability, Infineon recommends operating conditions that do not exceed 80% of the maximum ratings stated in this datasheet.

4 Characteristics diagrams

Power dissipation as a function of case temperature

$P_{\text{tot}} = f(T_c)$
 $T_{\text{vj}} \leq 175\text{ °C}$

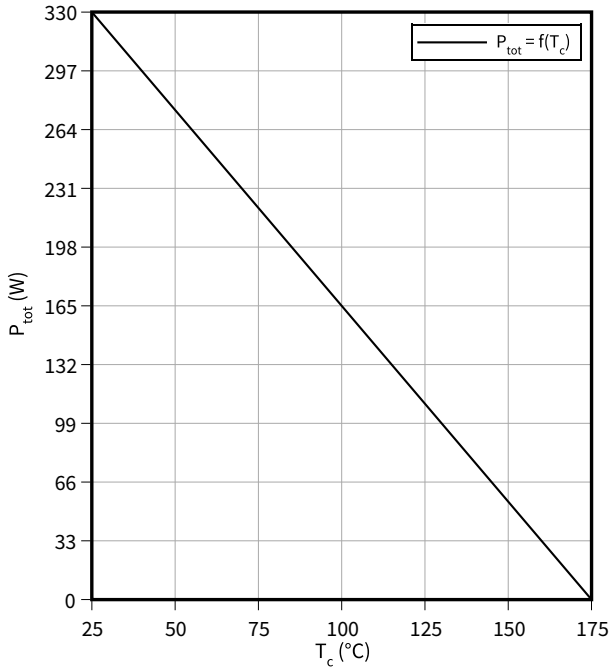

Collector current as a function of case temperature

$I_C = f(T_c)$
 $T_{\text{vj}} \leq 175\text{ °C}, V_{\text{GE}} \geq 15\text{ V}$

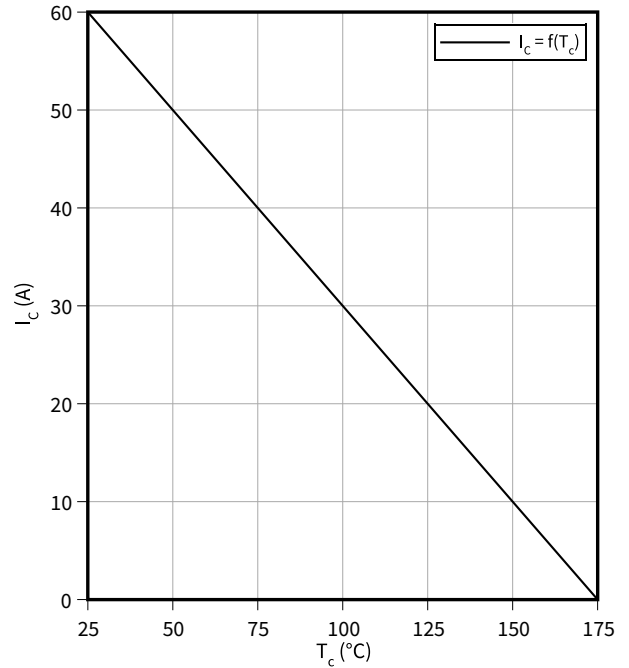

Typical output characteristic

$I_C = f(V_{\text{CE}})$
 $T_{\text{vj}} = 25\text{ °C}$

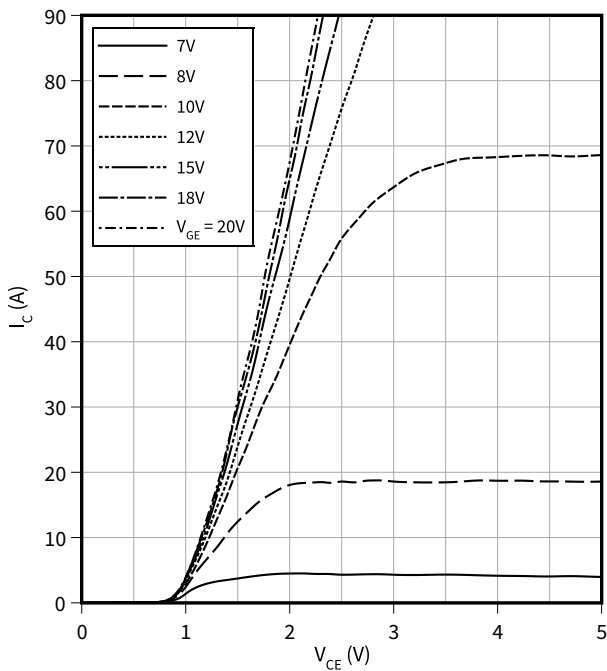

Typical output characteristic

$I_C = f(V_{\text{CE}})$
 $T_{\text{vj}} = 175\text{ °C}$

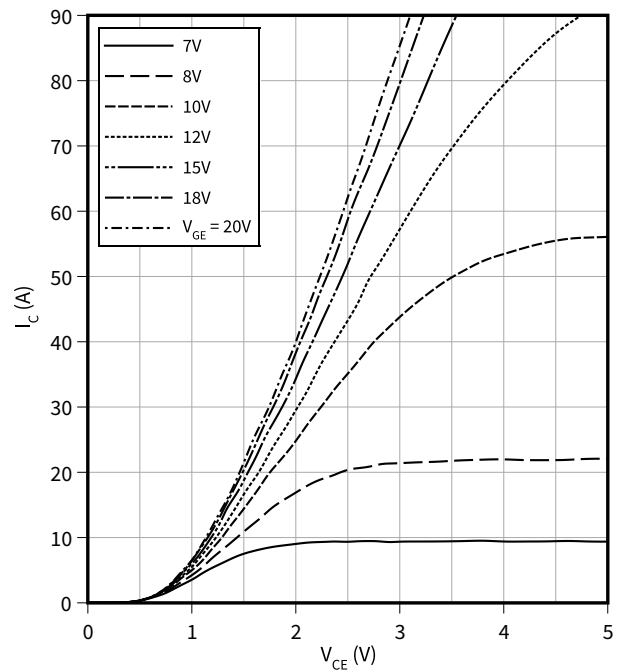

4 Characteristics diagrams

Typical transfer characteristic

$I_C = f(V_{GE})$

$V_{CE} = 20\text{ V}$

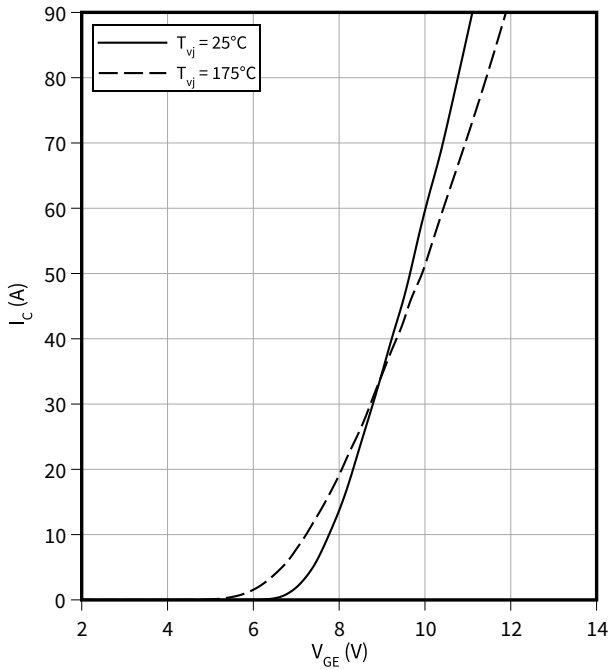

Typical collector-emitter saturation voltage as a function of junction temperature

$V_{CEsat} = f(T_{vj})$

$V_{GE} = 15\text{ V}$

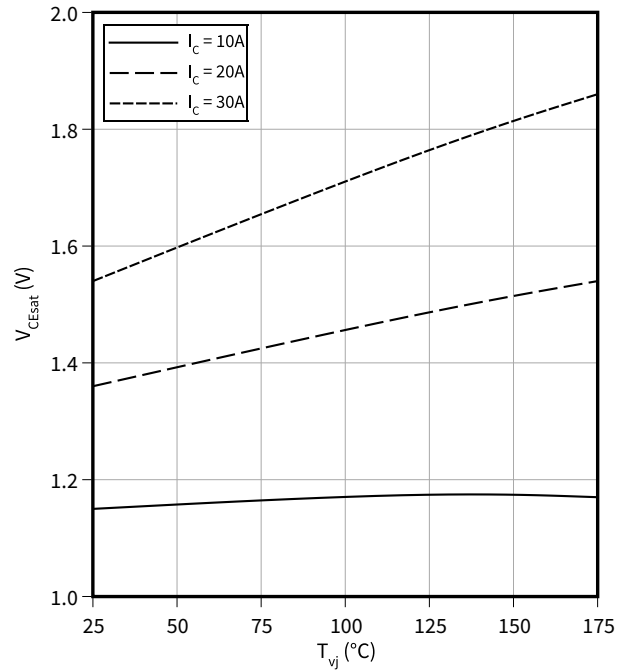

Gate-emitter threshold voltage as a function of junction temperature

$V_{GEth} = f(T_{vj})$

$I_C = 0.75\text{ mA}$

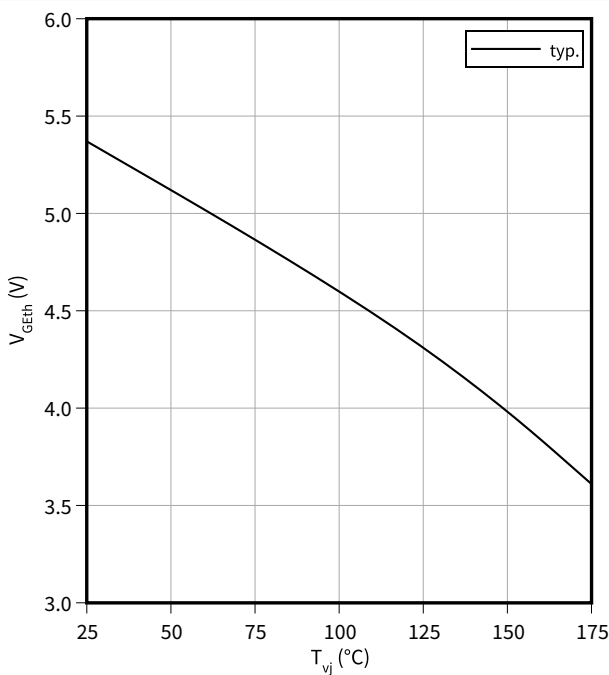

Typical switching times as a function of collector current

$t = f(I_C)$

$V_{CC} = 600\text{ V}, T_{vj} = 175^\circ\text{C}, V_{GE} = 0/15\text{ V}, R_G = 10\ \Omega$

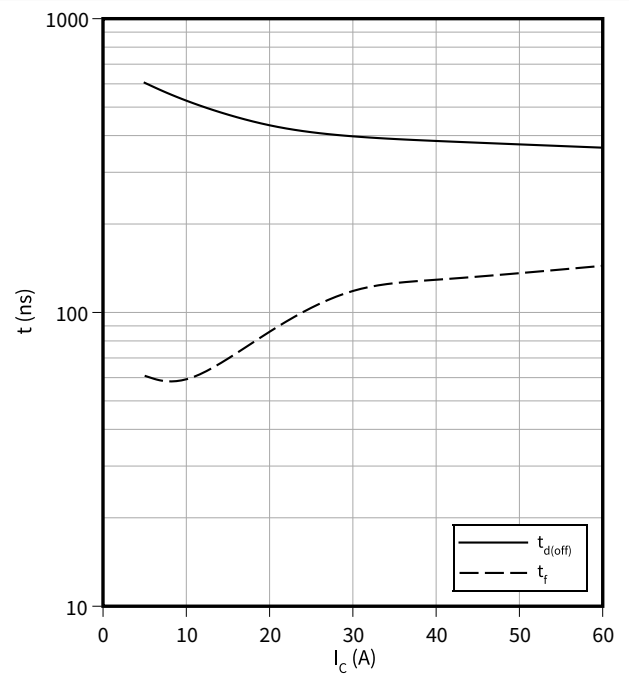

4 Characteristics diagrams

Typical switching times as a function of gate resistor

$t = f(R_G)$

$I_C = 30\text{ A}, V_{CC} = 600\text{ V}, T_{vj} = 175\text{ °C}, V_{GE} = 0/15\text{ V}$

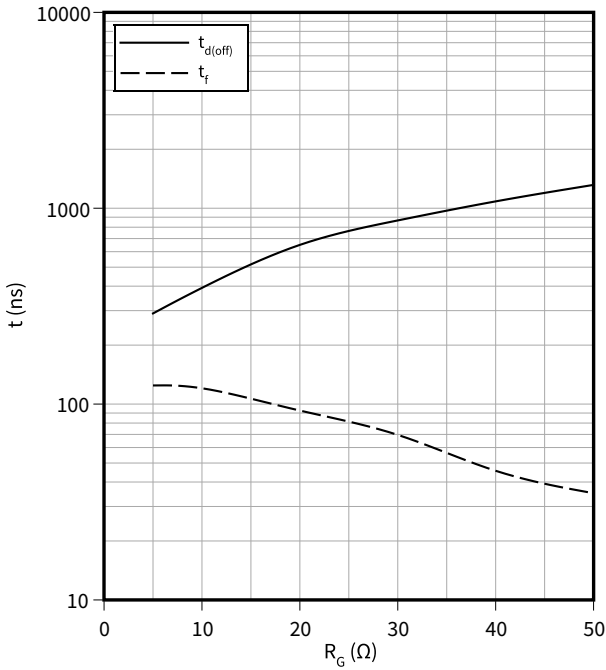

Typical switching times as a function of junction temperature

$t = f(T_{vj})$

$I_C = 30\text{ A}, V_{CC} = 600\text{ V}, V_{GE} = 0/15\text{ V}, R_G = 10\text{ Ω}$

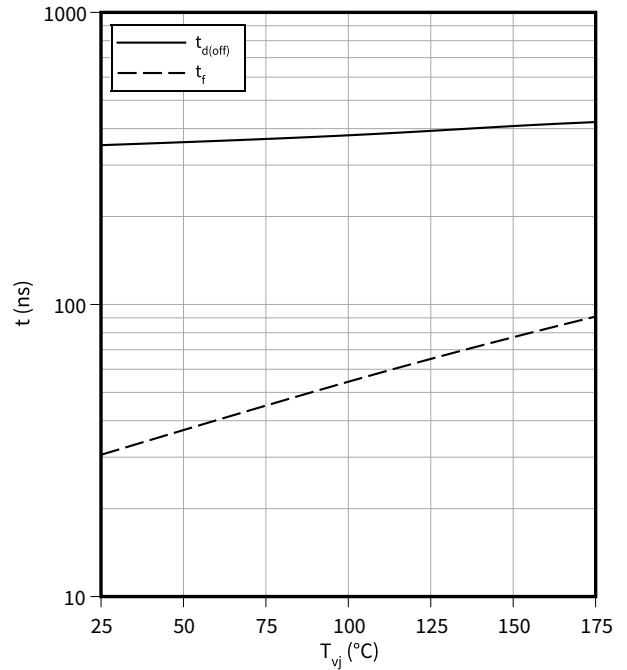

Typical switching energy losses as a function of collector current

$E = f(I_C)$

$V_{CC} = 600\text{ V}, T_{vj} = 175\text{ °C}, V_{GE} = 0/15\text{ V}, R_G = 10\text{ Ω}$

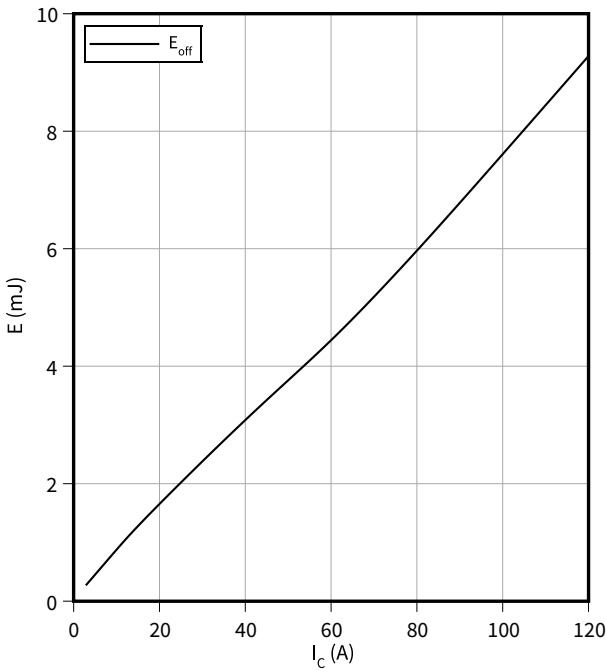

Typical switching energy losses as a function of gate resistor

$E = f(R_G)$

$I_C = 30\text{ A}, V_{CC} = 600\text{ V}, T_{vj} = 175\text{ °C}, V_{GE} = 0/15\text{ V}$

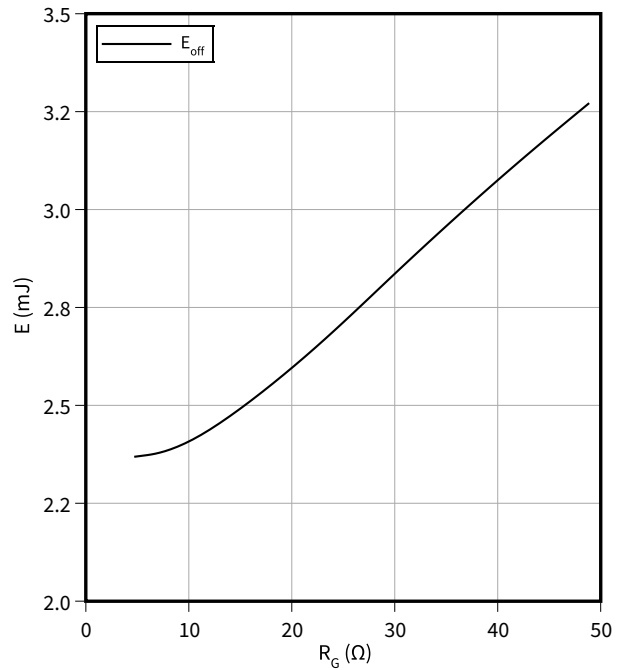

4 Characteristics diagrams

Typical switching energy losses as a function of junction temperature

$E = f(T_{vj})$

$I_C = 30\text{ A}$, $V_{CC} = 600\text{ V}$, $V_{GE} = 0/15\text{ V}$, $R_G = 10\ \Omega$

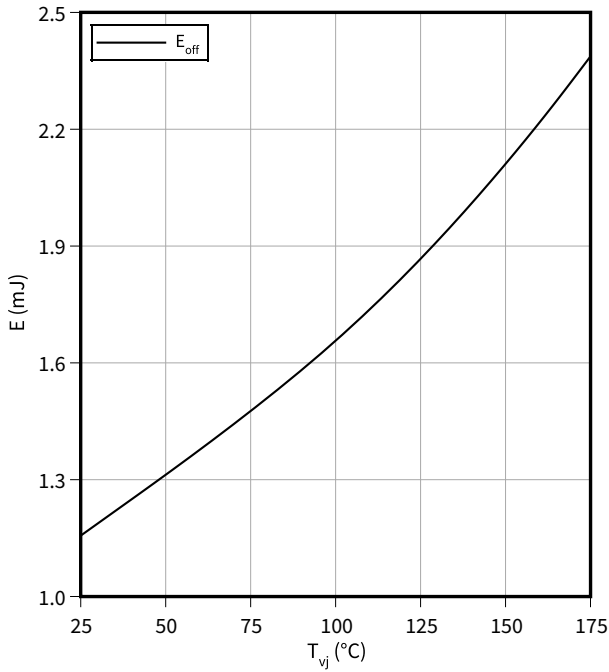

Typical switching energy losses as a function of collector emitter voltage

$E = f(V_{CE})$

$I_C = 30\text{ A}$, $T_{vj} = 175\text{ °C}$, $V_{GE} = 0/15\text{ V}$, $R_G = 10\ \Omega$

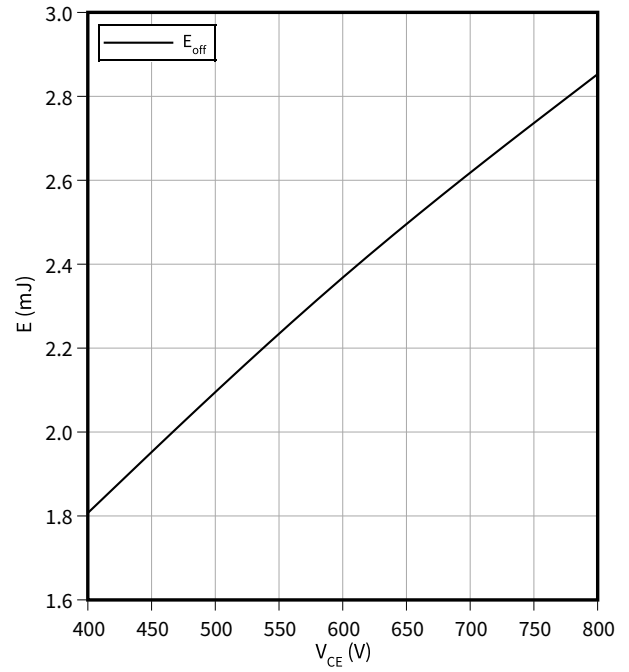

Typical turn off switching energy loss for soft switching

$E = f(I_C)$

$V_{GE} = 0/15\text{ V}$, $C_r = 270\text{ nF}$, $R_G = 10\ \Omega$

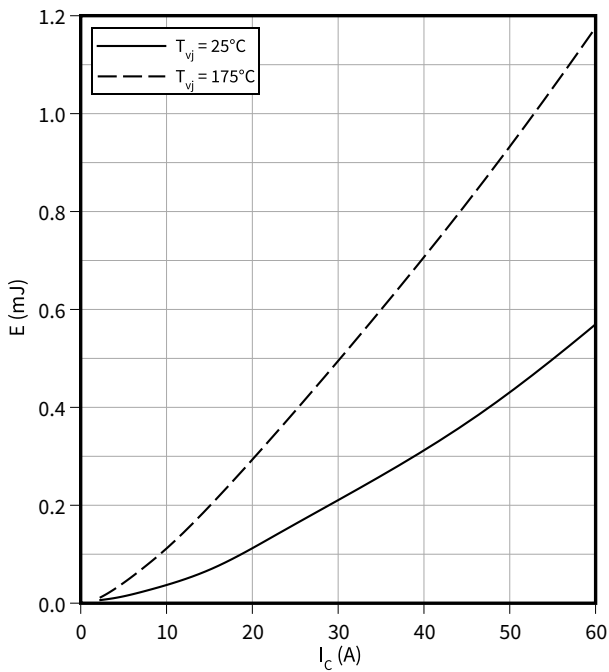

Typical gate charge

$V_{GE} = f(Q_G)$

$I_C = 30\text{ A}$

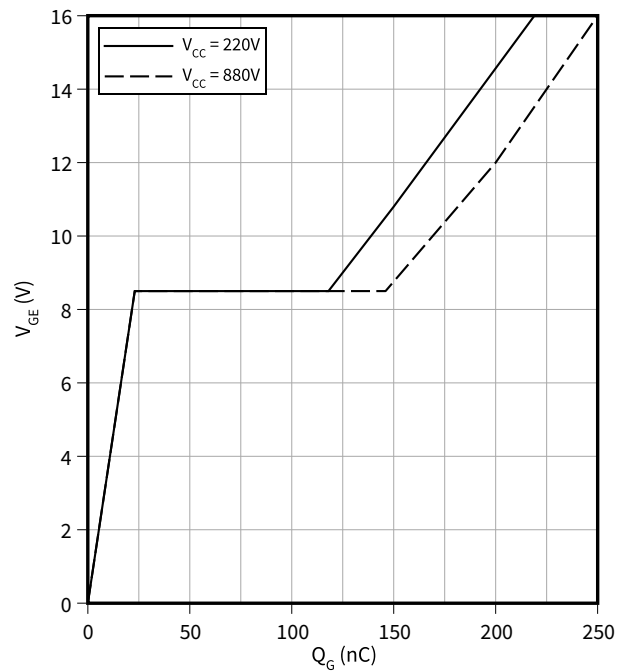

4 Characteristics diagrams

Typical capacitance as a function of collector-emitter voltage

$C = f(V_{CE})$
 $f = 100 \text{ kHz}, V_{GE} = 0 \text{ V}$

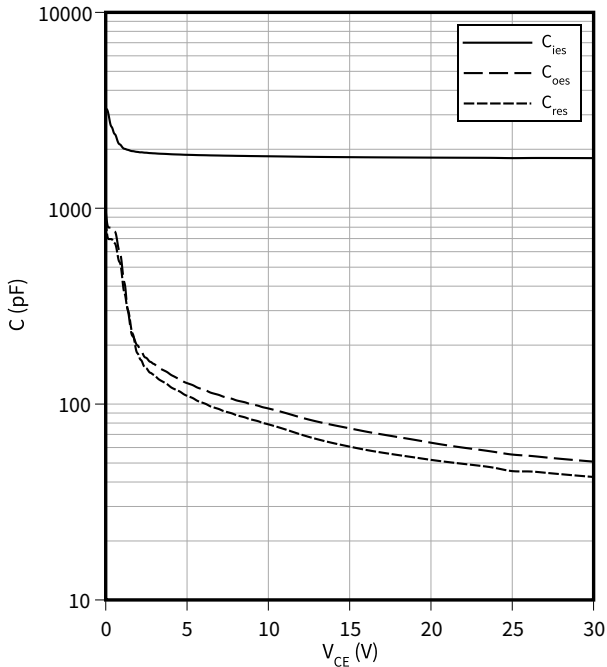

IGBT transient thermal impedance as a function of pulse width

$Z_{th(j-c)} = f(t_p)$
 $D = t_p/T$

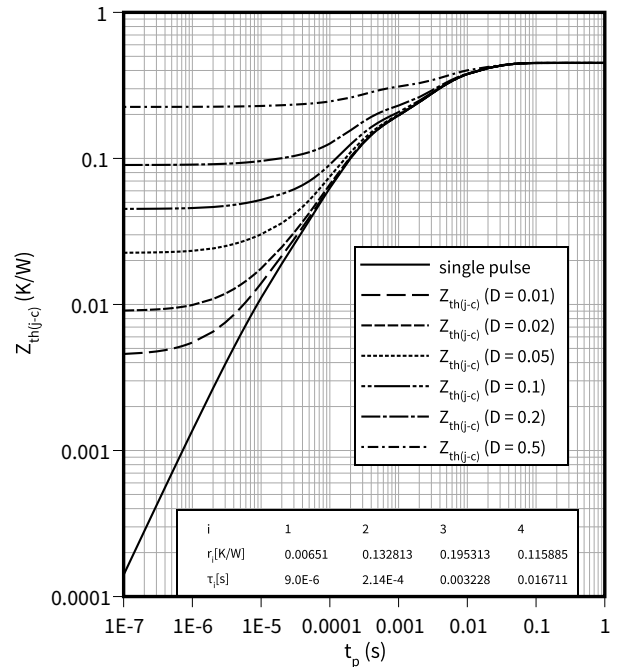

Diode transient thermal impedance as a function of pulse width

$Z_{th(j-c)} = f(t_p)$
 $D = t_p/T$

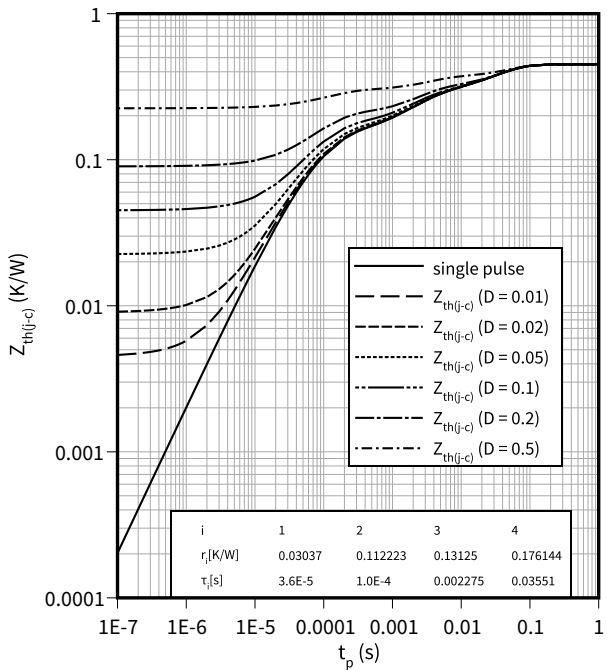

Typical diode forward current as a function of forward voltage

$I_F = f(V_F)$

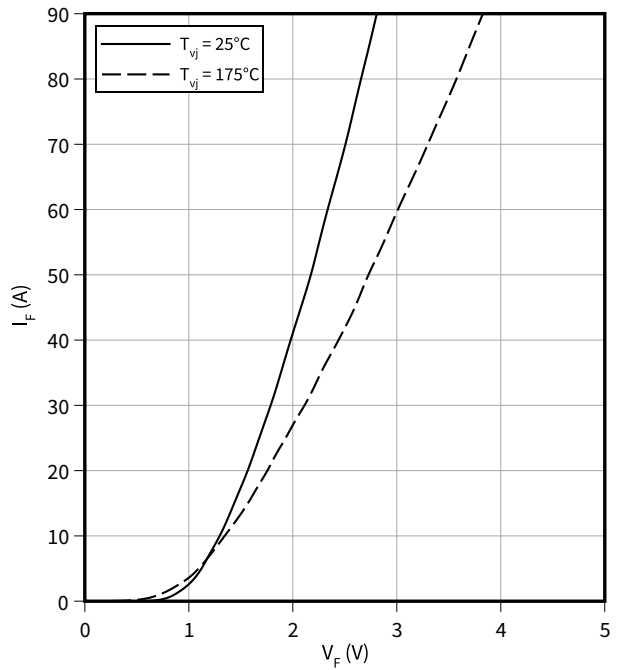

Typical diode forward voltage as a function of junction temperature

$$V_F = f(T_{vj})$$

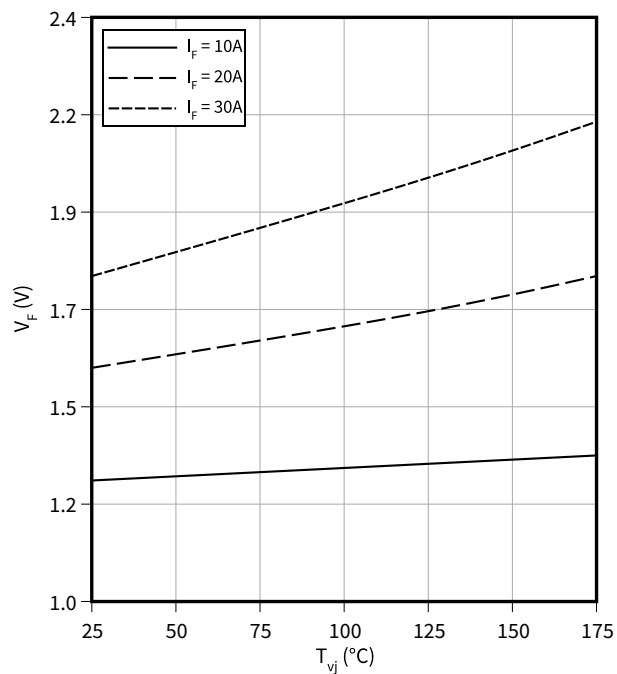

5 Package outlines

PG-TO247-3-STD-NN2.5

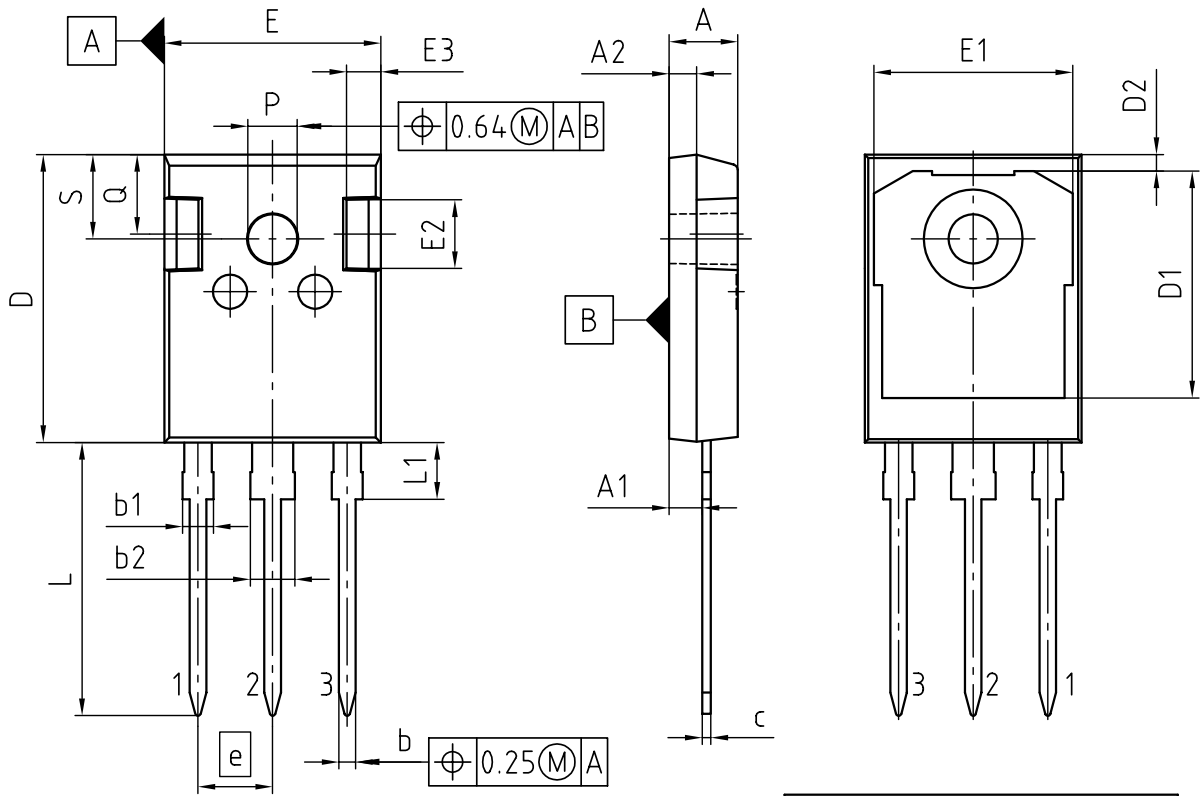

PACKAGE - GROUP NUMBER: PG-TO247-3-U06		
DIMENSIONS	MILLIMETERS	
	MIN.	MAX.
A	4.83	5.21
A1	2.27	2.54
A2	1.85	2.16
b	1.07	1.33
b1	1.90	2.41
b2	2.87	3.38
c	0.55	0.68
D	20.80	21.10
D1	16.25	17.65
D2	0.95	1.35
E	15.70	16.13
E1	13.10	14.15
E2	3.68	5.10
E3	1.00	2.60
e	5.44	
N	3	
L	19.80	20.32
L1	4.10	4.47
ϕP	3.50	3.70
Q	5.49	6.00
S	6.04	6.30

NOTE:
DIMENSIONS DO NOT INCLUDE MOLDFLASH; PROTRUSION OR GATE BURRS

Figure 1

6 Testing conditions

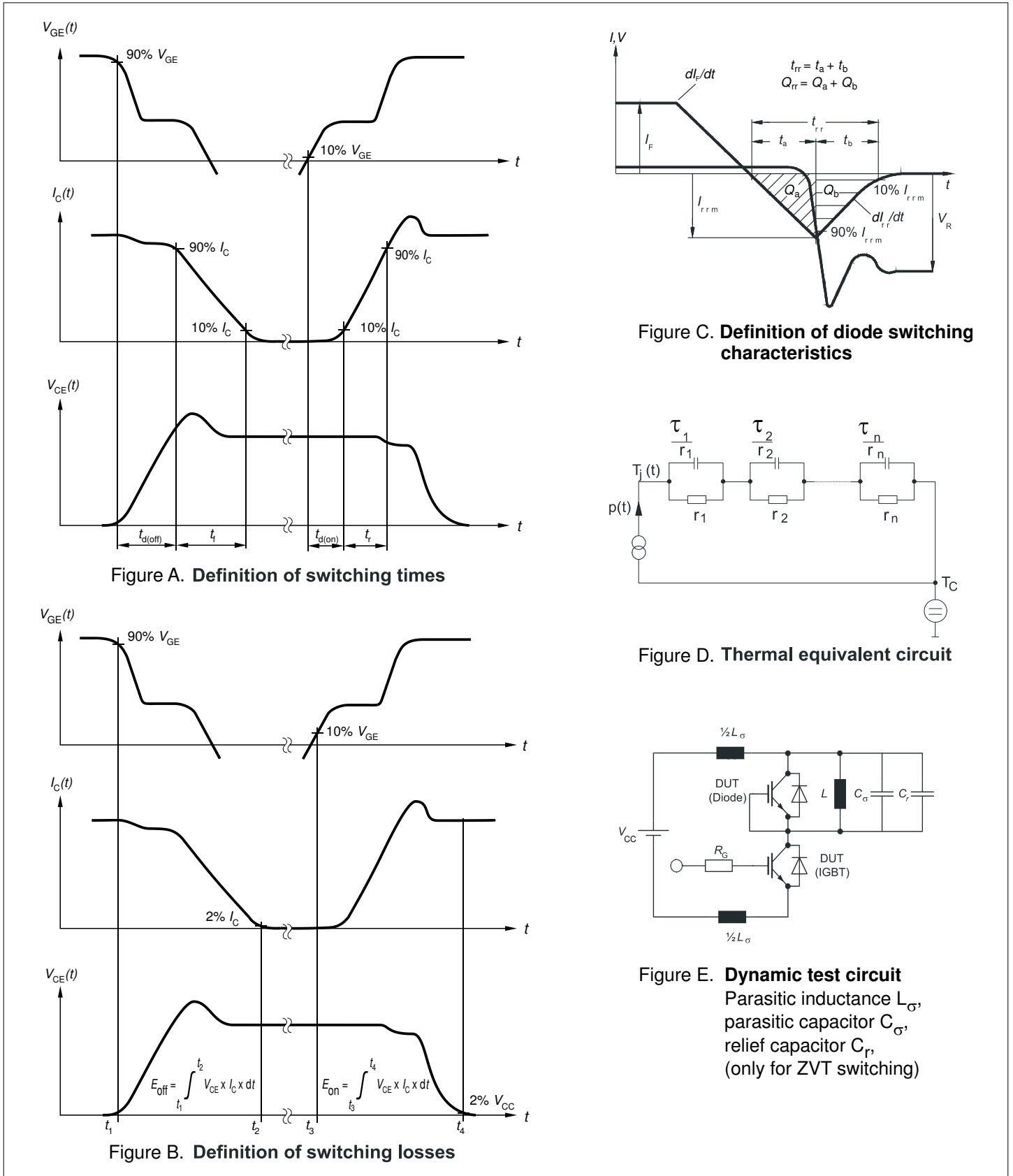

Figure 2

Revision history

Document revision	Date of release	Description of changes
1.00	2022-05-18	Final datasheet
1.10	2023-06-06	Table 3 on page 4 updated Figures on page 9 updated Editorial changes

Trademarks

All referenced product or service names and trademarks are the property of their respective owners.

Edition 2023-06-06

Published by

Infineon Technologies AG

81726 Munich, Germany

© 2023 Infineon Technologies AG

All Rights Reserved.

Do you have a question about any aspect of this document?

Email: erratum@infineon.com

Document reference

IFX-ABC780-002

Important notice

The information given in this document shall in no event be regarded as a guarantee of conditions or characteristics ("Beschaffungsgarantie").

With respect to any examples, hints or any typical values stated herein and/or any information regarding the application of the product, Infineon Technologies hereby disclaims any and all warranties and liabilities of any kind, including without limitation warranties of non-infringement of intellectual property rights of any third party.

In addition, any information given in this document is subject to customer's compliance with its obligations stated in this document and any applicable legal requirements, norms and standards concerning customer's products and any use of the product of Infineon Technologies in customer's applications.

The data contained in this document is exclusively intended for technically trained staff. It is the responsibility of customer's technical departments to evaluate the suitability of the product for the intended application and the completeness of the product information given in this document with respect to such application.

Please note that this product is not qualified according to the AEC Q100 or AEC Q101 documents of the Automotive Electronics Council.

Warnings

Due to technical requirements products may contain dangerous substances. For information on the types in question please contact your nearest Infineon Technologies office.

Except as otherwise explicitly approved by Infineon Technologies in a written document signed by authorized representatives of Infineon Technologies, Infineon Technologies' products may not be used in any applications where a failure of the product or any consequences of the use thereof can reasonably be expected to result in personal injury.