

## Final datasheet

### IHM-B module with Trench/Fieldstop IGBT4 and emitter controlled 4 diode

#### Features

- Electrical features
  - $V_{CES} = 4500\text{ V}$
  - $I_{C\text{ nom}} = 1800\text{ A} / I_{CRM} = 3600\text{ A}$
  - High DC stability
  - High dynamic robustness
  - High short-circuit capability
  - Low  $V_{CE,sat}$
  - Trench IGBT 4
  - $V_{CE,sat}$  with positive temperature coefficient
- Mechanical features
  - Package with CTI > 600
  - Standard housing
  - AlSiC base plate for increased thermal cycling capability
  - IHM B housing
  - Isolated base plate



Typical appearance

#### Potential applications

- High-power converters
- Medium-voltage converters
- Power transmission and distribution

#### Product validation

- Qualified for industrial applications according to the relevant tests of IEC 60747, 60749 and 60068

#### Description

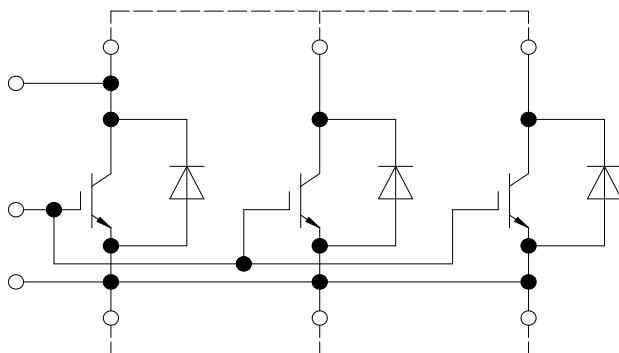

external connection  
(to be done)

## Table of contents

	<b>Description</b> .....	1
	<b>Features</b> .....	1
	<b>Potential applications</b> .....	1
	<b>Product validation</b> .....	1
	<b>Table of contents</b> .....	2
<b>1</b>	<b>Package</b> .....	3
<b>2</b>	<b>IGBT, Inverter</b> .....	3
<b>3</b>	<b>Diode, Inverter</b> .....	5
<b>4</b>	<b>Characteristics diagrams</b> .....	7
<b>5</b>	<b>Circuit diagram</b> .....	11
<b>6</b>	<b>Package outlines</b> .....	11
<b>7</b>	<b>Module label code</b> .....	12
	<b>Revision history</b> .....	13
	<b>Disclaimer</b> .....	14

## 1 Package

**Table 1** Insulation coordination

Parameter	Symbol	Note or test condition	Values	Unit
Isolation test voltage	$V_{ISOL}$	RMS, $f = 50 \text{ Hz}$ , $t = 1 \text{ min}$	6.0	kV
Partial discharge extinction voltage	$V_{isol}$	RMS, $f = 50 \text{ Hz}$ , $Q_{PD} \leq 10 \text{ pC}$	3.5	kV
DC stability	$V_{CE(D)}$	$T_{vj}=25^{\circ}\text{C}$ , 100 Fit	2900	V
Material of module baseplate			AlSiC	
Creepage distance	$d_{Creep}$	terminal to heatsink	32.2	mm
Clearance	$d_{Clear}$	terminal to heatsink	19.1	mm
Comparative tracking index	$CTI$		> 600	

**Table 2** Characteristic values

Parameter	Symbol	Note or test condition	Values			Unit	
			Min.	Typ.	Max.		
Stray inductance module	$L_{sCE}$			6		nH	
Module lead resistance, terminals - chip	$R_{AA'+CC'}$	$T_C=25^{\circ}\text{C}$ , per switch		0.08		mΩ	
Module lead resistance, terminals - chip	$R_{CC'+EE'}$	$T_C=25^{\circ}\text{C}$ , per switch		0.095		mΩ	
Storage temperature	$T_{stg}$		-40		150	°C	
Mounting torque for module mounting	$M$	- Mounting according to valid application note	M6, Screw	4.25		5.75	Nm
Terminal connection torque	$M$	- Mounting according to valid application note	M4, Screw	1.8		2.1	Nm
			M8, Screw	8		10	
Weight	$G$			1200		g	

## 2 IGBT, Inverter

**Table 3** Maximum rated values

Parameter	Symbol	Note or test condition	Values	Unit	
Collector-emitter voltage	$V_{CES}$		$T_{vj} = -40^{\circ}\text{C}$	4300	V
			$T_{vj} = 150^{\circ}\text{C}$	4500	
Continuous DC collector current	$I_{CDC}$	$T_{vj \text{ max}} = 150^{\circ}\text{C}$	$T_C = 105^{\circ}\text{C}$	1800	A
Repetitive peak collector current	$I_{CRM}$	$t_p$ limited by $T_{vj \text{ op}}$		3600	A
Gate-emitter peak voltage	$V_{GES}$			-20/26.25	V

**Table 4** Characteristic values

Parameter	Symbol	Note or test condition	Values			Unit	
			Min.	Typ.	Max.		
Collector-emitter saturation voltage	$V_{CE\ sat}$	$I_C = 1800\ A, V_{GE} = 25\ V$	$T_{vj} = 25\ ^\circ C$		2.15	2.60	V
			$T_{vj} = 125\ ^\circ C$		2.50	3.05	
			$T_{vj} = 150\ ^\circ C$		2.60	3.15	
Gate threshold voltage	$V_{GETh}$	$I_C = 149\ mA, V_{CE} = V_{GE}, T_{vj} = 25\ ^\circ C$		5.5	6	6.5	V
Gate charge	$Q_G$	$V_{GE} = \pm 15\ V, V_{CC} = 2800\ V$			47		$\mu C$
Internal gate resistor	$R_{Gint}$	$T_{vj} = 25\ ^\circ C$			0.29		$\Omega$
Input capacitance	$C_{ies}$	$f = 100\ kHz, T_{vj} = 25\ ^\circ C, V_{CE} = 25\ V, V_{GE} = 0\ V$			297		nF
Reverse transfer capacitance	$C_{res}$	$f = 100\ kHz, T_{vj} = 25\ ^\circ C, V_{CE} = 25\ V, V_{GE} = 0\ V$			5.4		nF
Collector-emitter cut-off current	$I_{CES}$	$V_{CE} = 4500\ V, V_{GE} = 0\ V$	$T_{vj} = 25\ ^\circ C$			5	mA
Gate-emitter leakage current	$I_{GES}$	$V_{CE} = 0\ V, V_{GE} = 20\ V, T_{vj} = 25\ ^\circ C$				400	nA
Turn-on delay time (inductive load)	$t_{don}$	$I_C = 1800\ A, V_{CC} = 2800\ V, V_{GE} = \pm 15\ V, R_{Gon} = 0.75\ \Omega$	$T_{vj} = 25\ ^\circ C$		0.260		$\mu s$
			$T_{vj} = 125\ ^\circ C$		0.290		
			$T_{vj} = 150\ ^\circ C$		0.310		
Rise time (inductive load)	$t_r$	$I_C = 1800\ A, V_{CC} = 2800\ V, V_{GE} = \pm 15\ V, R_{Gon} = 0.75\ \Omega$	$T_{vj} = 25\ ^\circ C$		0.210		$\mu s$
			$T_{vj} = 125\ ^\circ C$		0.230		
			$T_{vj} = 150\ ^\circ C$		0.230		
Turn-off delay time (inductive load)	$t_{doff}$	$I_C = 1800\ A, V_{CC} = 2800\ V, V_{GE} = \pm 15\ V, R_{Goff} = 4.7\ \Omega$	$T_{vj} = 25\ ^\circ C$		6.930		$\mu s$
			$T_{vj} = 125\ ^\circ C$		7.320		
			$T_{vj} = 150\ ^\circ C$		7.410		
Fall time (inductive load)	$t_f$	$I_C = 1800\ A, V_{CC} = 2800\ V, V_{GE} = \pm 15\ V, R_{Goff} = 4.7\ \Omega$	$T_{vj} = 25\ ^\circ C$		1.130		$\mu s$
			$T_{vj} = 125\ ^\circ C$		2.630		
			$T_{vj} = 150\ ^\circ C$		2.850		
Turn-on time (resistive load)	$t_{on\_R}$	$I_C = 500\ A, V_{CC} = 2000\ V, V_{GE} = \pm 15\ V, R_{Gon} = 0.75\ \Omega$	$T_{vj} = 25\ ^\circ C$	0.86			$\mu s$
Turn-on energy loss per pulse	$E_{on}$	$I_C = 1800\ A, V_{CC} = 2800\ V, L_\sigma = 110\ nH, V_{GE} = \pm 15\ V, R_{Gon} = 0.75\ \Omega, di/dt = 6500\ A/\mu s (T_{vj} = 150\ ^\circ C)$	$T_{vj} = 25\ ^\circ C$		5800		mJ
			$T_{vj} = 125\ ^\circ C$		8100		
			$T_{vj} = 150\ ^\circ C$		9100		
Turn-off energy loss per pulse	$E_{off}$	$I_C = 1800\ A, V_{CC} = 2800\ V, L_\sigma = 110\ nH, V_{GE} = \pm 15\ V, R_{Goff} = 4.7\ \Omega, dv/dt = 1250\ V/\mu s (T_{vj} = 150\ ^\circ C)$	$T_{vj} = 25\ ^\circ C$		7050		mJ
			$T_{vj} = 125\ ^\circ C$		9000		
			$T_{vj} = 150\ ^\circ C$		9700		

(table continues...)

**Table 4 (continued) Characteristic values**

Parameter	Symbol	Note or test condition	Values			Unit
			Min.	Typ.	Max.	
SC data	$I_{SC}$	$V_{GE} = 15\text{ V}$ , $V_{CC} = 3000\text{ V}$ , $V_{CEmax} = V_{CES} - L_{SCE} \cdot di/dt$ $t_p \leq 10\ \mu\text{s}$ , $T_{vj} = 150\text{ }^\circ\text{C}$		8100		A
Thermal resistance, junction to case	$R_{thJC}$	per IGBT			7.20	K/kW
Thermal resistance, case to heat sink	$R_{thCH}$	per IGBT, $\lambda_{grease} = 1\text{ W}/(\text{m}\cdot\text{K})$		3.60		K/kW
Temperature under switching conditions	$T_{vj\ op}$		-40		150	$^\circ\text{C}$

### 3 Diode, Inverter

**Table 5 Maximum rated values**

Parameter	Symbol	Note or test condition	Values			Unit
			Min.	Typ.	Max.	
Repetitive peak reverse voltage	$V_{RRM}$		$T_{vj} = -40\text{ }^\circ\text{C}$	4300		V
			$T_{vj} = 150\text{ }^\circ\text{C}$	4500		
Continuous DC forward current	$I_F$			1800		A
Repetitive peak forward current	$I_{FRM}$	$t_p = 1\text{ ms}$		3600		A
$I^2t$ - value	$I^2t$	$t_p = 10\text{ ms}$ , $V_R = 0\text{ V}$	$T_{vj} = 125\text{ }^\circ\text{C}$	930		kA <sup>2</sup> s
			$T_{vj} = 150\text{ }^\circ\text{C}$	850		
Maximum power dissipation	$P_{RQM}$		$T_{vj} = 150\text{ }^\circ\text{C}$	4000		kW
Minimum turn-on time	$t_{onmin}$			10		$\mu\text{s}$

**Table 6 Characteristic values**

Parameter	Symbol	Note or test condition	Values			Unit	
			Min.	Typ.	Max.		
Forward voltage	$V_F$	$I_F = 1800\text{ A}$ , $V_{GE} = 0\text{ V}$	$T_{vj} = 25\text{ }^\circ\text{C}$		2.60	3.05	V
			$T_{vj} = 125\text{ }^\circ\text{C}$		2.50	2.95	
			$T_{vj} = 150\text{ }^\circ\text{C}$		2.45	2.90	
Peak reverse recovery current	$I_{RM}$	$V_{CC} = 2800\text{ V}$ , $I_F = 1800\text{ A}$ , $V_{GE} = -15\text{ V}$ , $-di_F/dt = 6500\text{ A}/\mu\text{s}$ ( $T_{vj} = 150\text{ }^\circ\text{C}$ )	$T_{vj} = 25\text{ }^\circ\text{C}$		2360		A
			$T_{vj} = 125\text{ }^\circ\text{C}$		2600		
			$T_{vj} = 150\text{ }^\circ\text{C}$		2630		

**(table continues...)**

**Table 6** (continued) Characteristic values

Parameter	Symbol	Note or test condition	Values			Unit	
			Min.	Typ.	Max.		
Recovered charge	$Q_r$	$V_{CC} = 2800 \text{ V}$ , $I_F = 1800 \text{ A}$ , $V_{GE} = -15 \text{ V}$ , $-di_F/dt =$ $6500 \text{ A}/\mu\text{s}$ ( $T_{vj} = 150 \text{ }^\circ\text{C}$ )	$T_{vj} = 25 \text{ }^\circ\text{C}$		1560		$\mu\text{C}$
			$T_{vj} = 125 \text{ }^\circ\text{C}$		3060		
			$T_{vj} = 150 \text{ }^\circ\text{C}$		3560		
Reverse recovery energy	$E_{rec}$	$V_{CC} = 2800 \text{ V}$ , $I_F = 1800 \text{ A}$ , $V_{GE} = -15 \text{ V}$ , $-di_F/dt =$ $6500 \text{ A}/\mu\text{s}$ ( $T_{vj} = 150 \text{ }^\circ\text{C}$ )	$T_{vj} = 25 \text{ }^\circ\text{C}$		2340		mJ
			$T_{vj} = 125 \text{ }^\circ\text{C}$		5200		
			$T_{vj} = 150 \text{ }^\circ\text{C}$		6100		
Thermal resistance, junction to case	$R_{thJC}$	per diode				12.7	K/kW
Thermal resistance, case to heat sink	$R_{thCH}$	per diode, $\lambda_{grease} = 1 \text{ W}/(\text{m}\cdot\text{K})$			5.30		K/kW
Temperature under switching conditions	$T_{vjop}$			-40		150	$^\circ\text{C}$

**4 Characteristics diagrams**

**Output characteristic (typical), IGBT, Inverter**

$I_C = f(V_{CE})$   
 $V_{GE} = 25 \text{ V}$

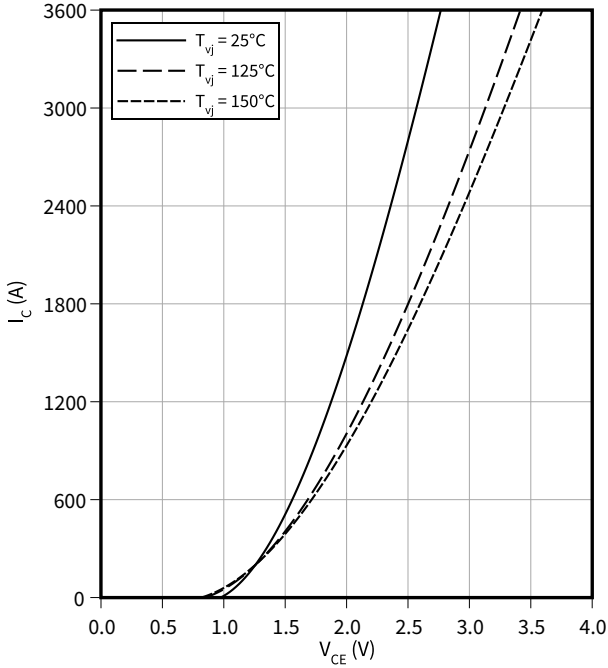

**Output characteristic field (typical), IGBT, Inverter**

$I_C = f(V_{CE})$   
 $T_{vj} = 150 \text{ °C}$

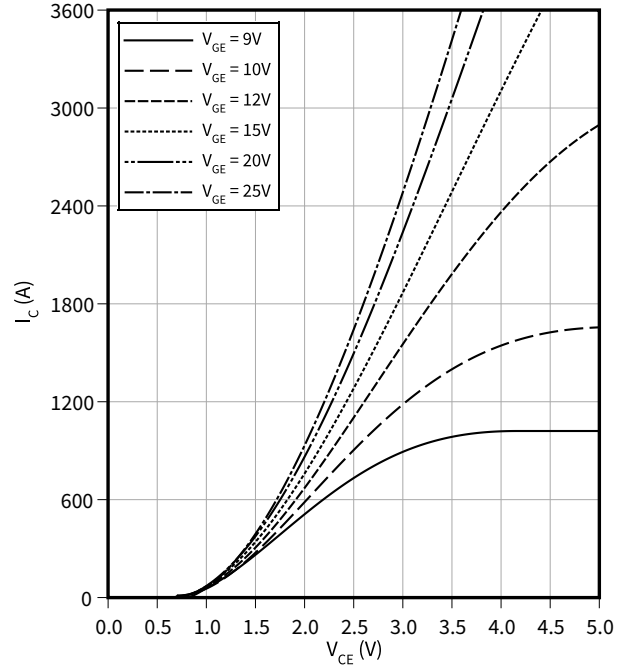

**Transfer characteristic (typical), IGBT, Inverter**

$I_C = f(V_{GE})$   
 $V_{CE} = 20 \text{ V}$

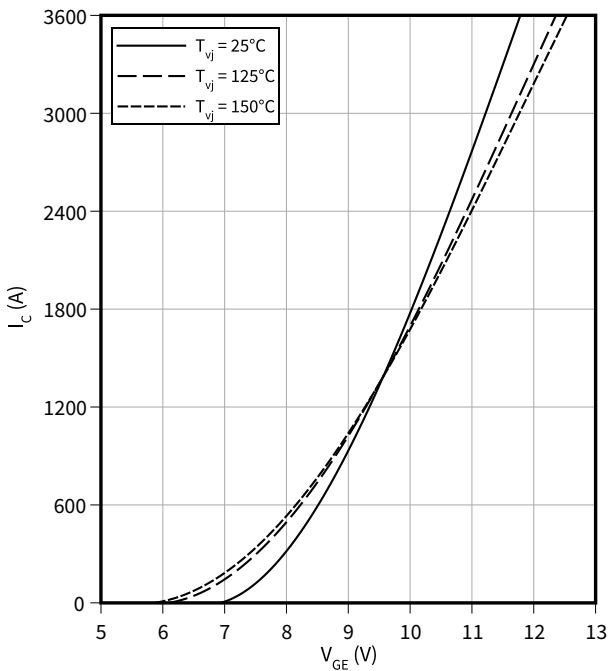

**Gate charge characteristic (typical), IGBT, Inverter**

$V_{GE} = f(Q_G)$   
 $I_C = 1800 \text{ A}, T_{vj} = 25 \text{ °C}$

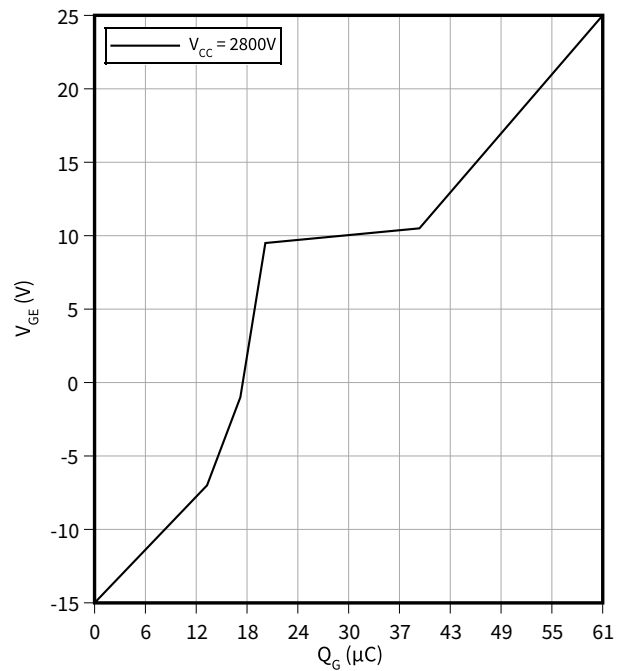

**4 Characteristics diagrams**

**Capacity characteristic (typical), IGBT, Inverter**

$C = f(V_{CE})$   
 $f = 100 \text{ kHz}, V_{GE} = 0 \text{ V}, T_{vj} = 25 \text{ }^\circ\text{C}$

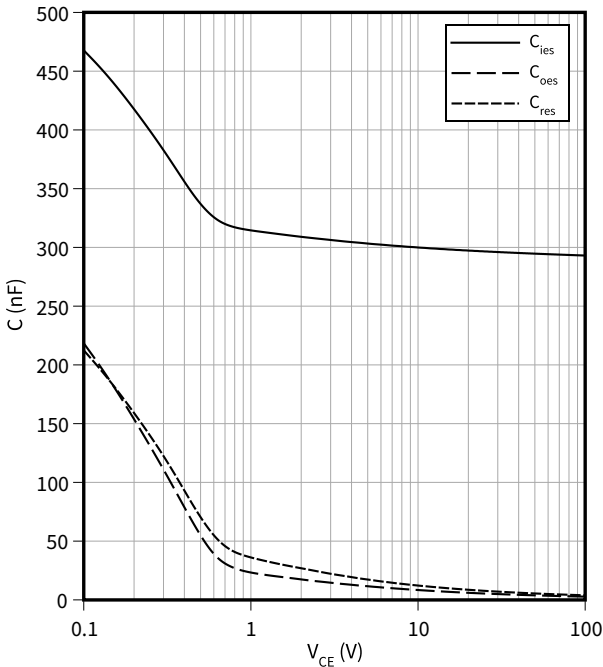

**Switching times (typical), IGBT, Inverter**

$t = f(I_C)$   
 $R_{Goff} = 4.7 \text{ } \Omega, R_{Gon} = 0.75 \text{ } \Omega, V_{GE} = \pm 15 \text{ V}, V_{CC} = 2800 \text{ V}, T_{vj} = 150 \text{ }^\circ\text{C}$

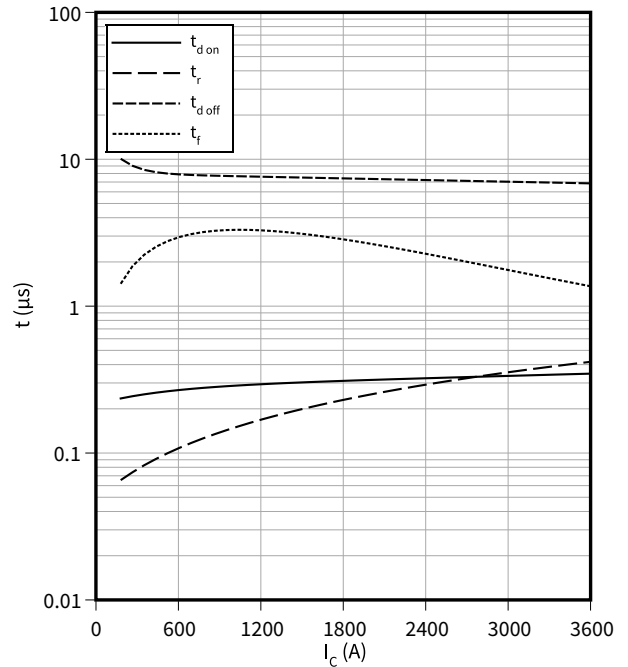

**Switching times (typical), IGBT, Inverter**

$t = f(R_G)$   
 $V_{GE} = \pm 15 \text{ V}, I_C = 1800 \text{ A}, V_{CC} = 2800 \text{ V}, T_{vj} = 150 \text{ }^\circ\text{C}$

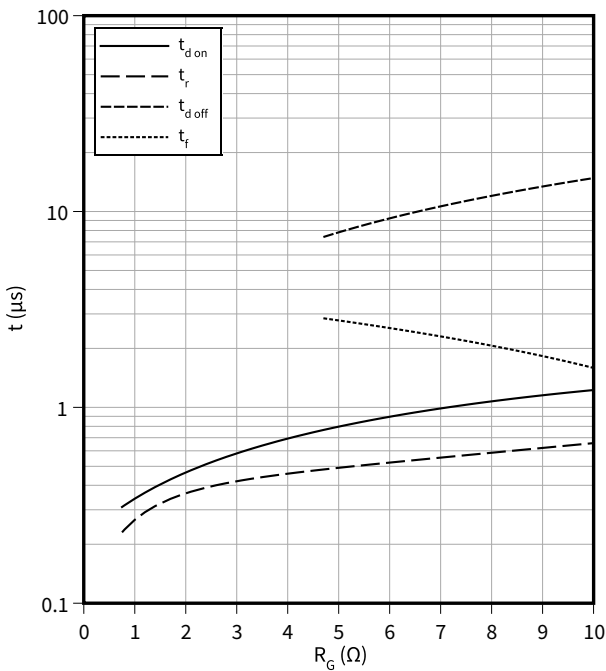

**Switching losses (typical), IGBT, Inverter**

$E = f(I_C)$   
 $R_{Goff} = 4.7 \text{ } \Omega, R_{Gon} = 0.75 \text{ } \Omega, V_{GE} = \pm 15 \text{ V}, V_{CC} = 2800 \text{ V}$

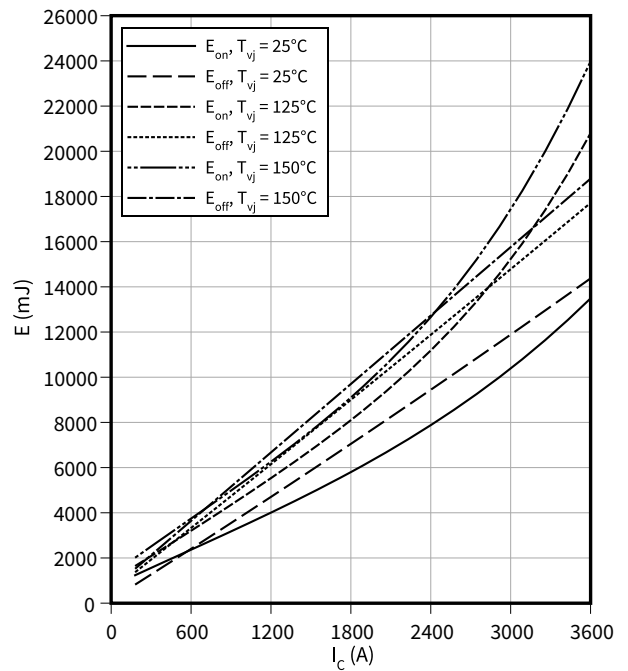



**4 Characteristics diagrams**

**Switching losses (typical), IGBT, Inverter**

$E = f(R_G)$

$V_{GE} = \pm 15 \text{ V}$ ,  $I_C = 1800 \text{ A}$ ,  $V_{CC} = 2800 \text{ V}$

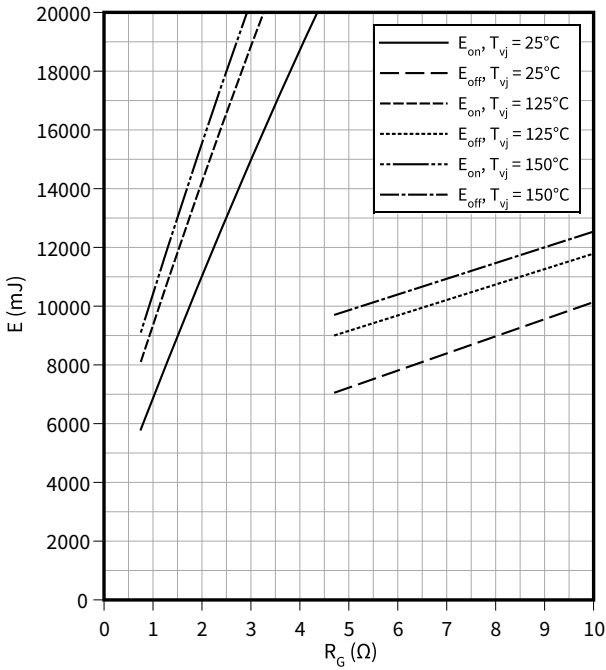

**Reverse bias safe operating area (RBSOA), IGBT, Inverter**

$I_C = f(V_{CE})$

$V_{CC} \leq 3200 \text{ V}$ ,  $T_{vj} = 150 \text{ °C}$ ,  $R_{Goff} = 4.7 \text{ } \Omega$ ,  $V_{GE} = \pm 15 \text{ V}$

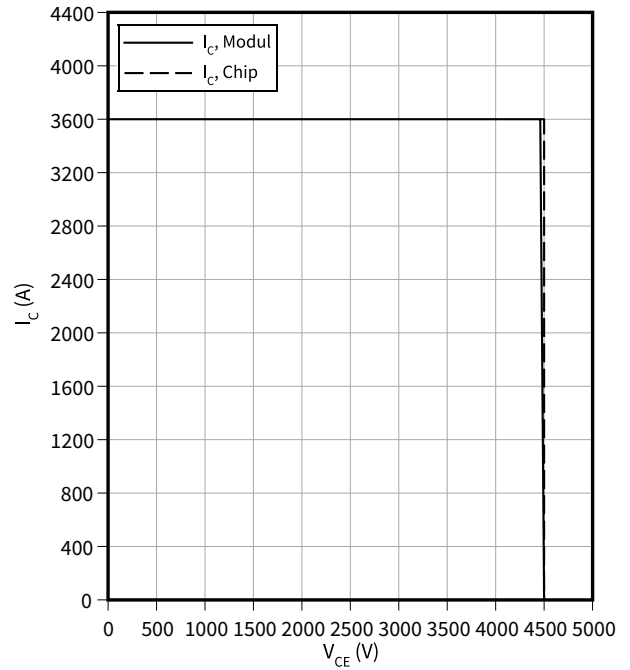

**Transient thermal impedance, IGBT, Inverter**

$Z_{th} = f(t)$

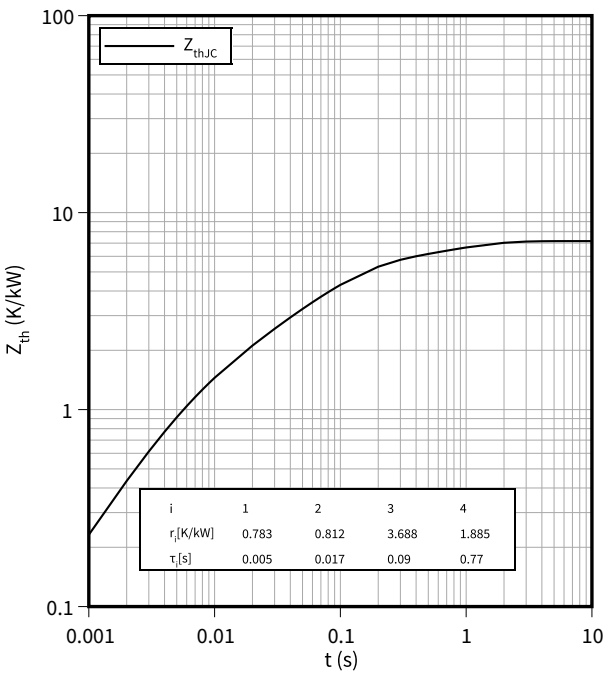

**Forward characteristic (typical), Diode, Inverter**

$I_F = f(V_F)$

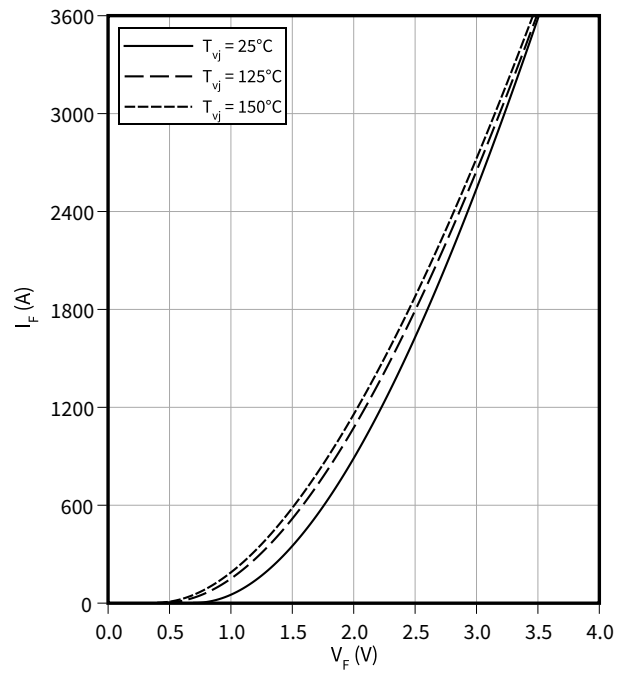

**4 Characteristics diagrams**

**Switching losses (typical), Diode, Inverter**

$E_{rec} = f(I_F)$

$R_{Gon} = R_{Gon}(IGBT), V_{CC} = 2800\text{ V}$

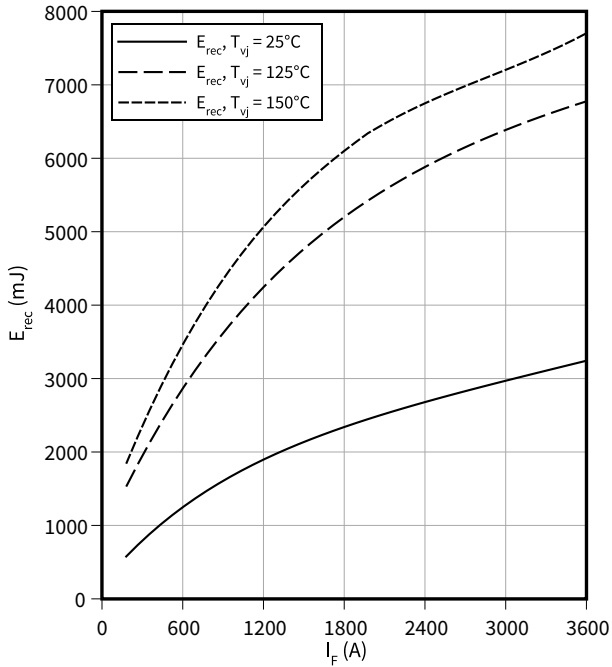

**Switching losses (typical), Diode, Inverter**

$E_{rec} = f(R_G)$

$I_F = 1800\text{ A}, V_{CC} = 2800\text{ V}$

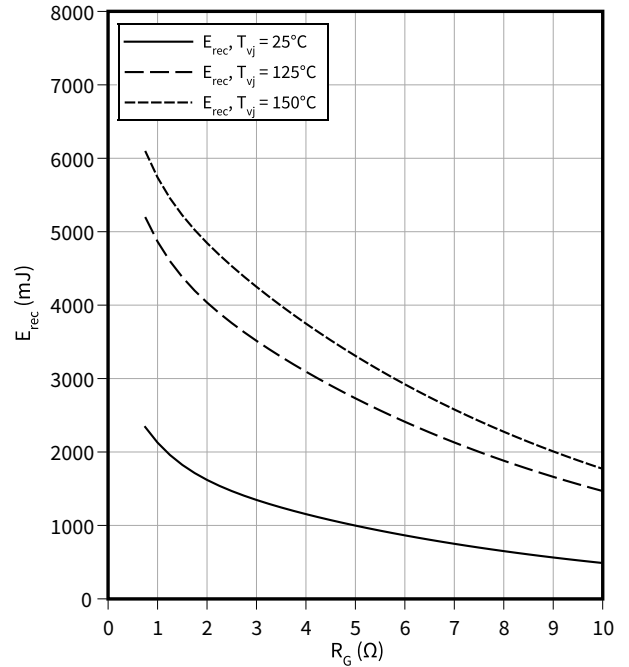

**Safe operating area (SOA), Diode, Inverter**

$I_R = f(V_R)$

$T_{vj} = 150\text{ °C}$

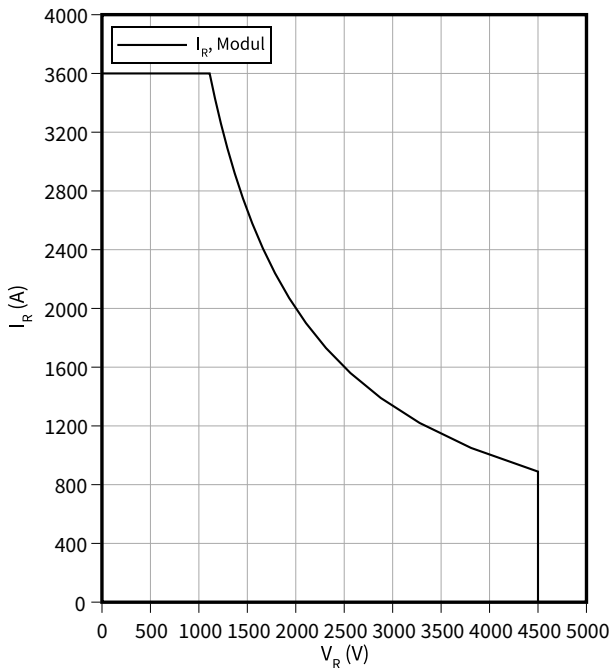

**Transient thermal impedance, Diode, Inverter**

$Z_{th} = f(t)$

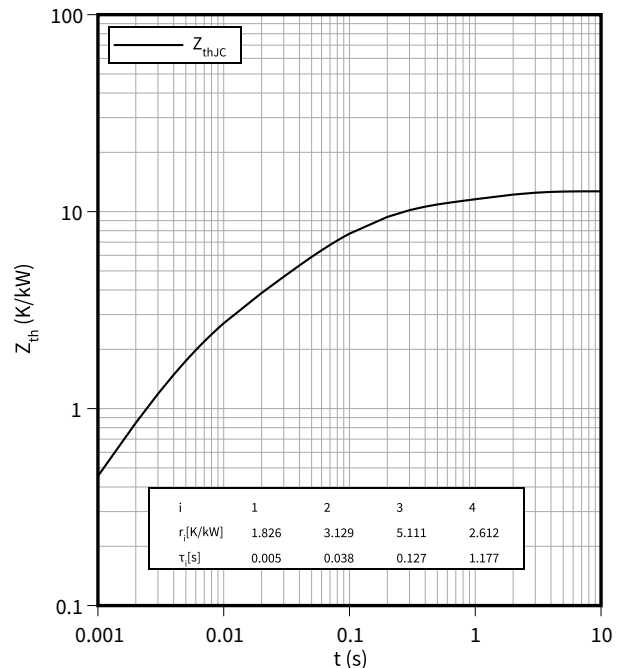

## 5 Circuit diagram

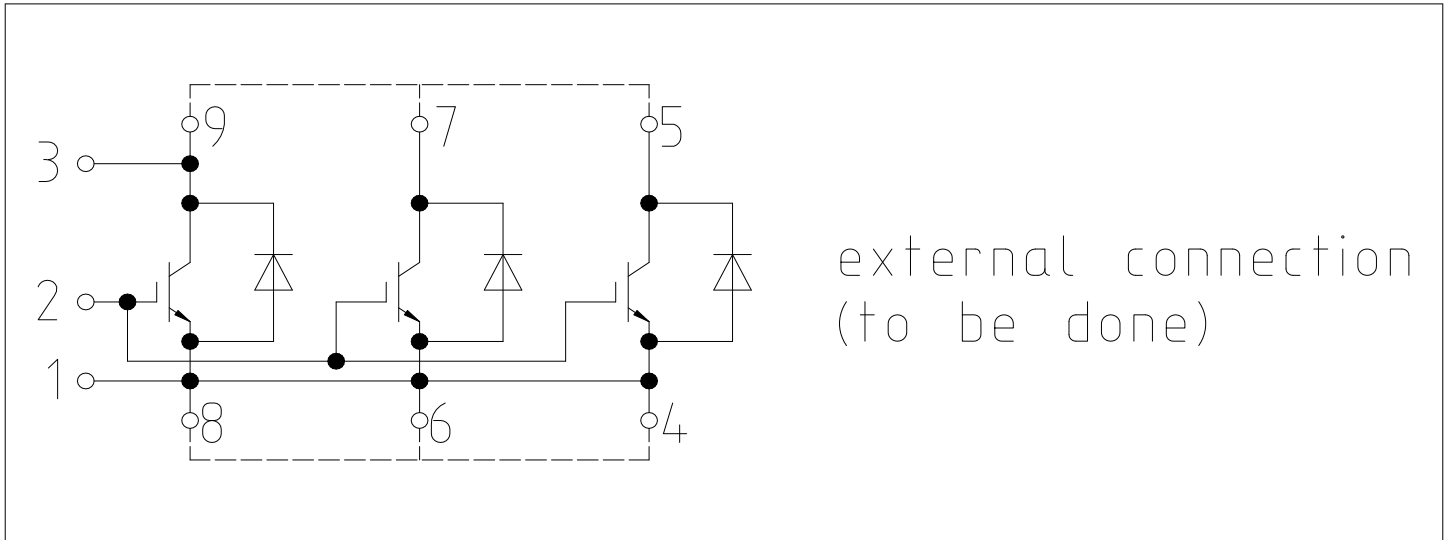

Figure 1

## 6 Package outlines

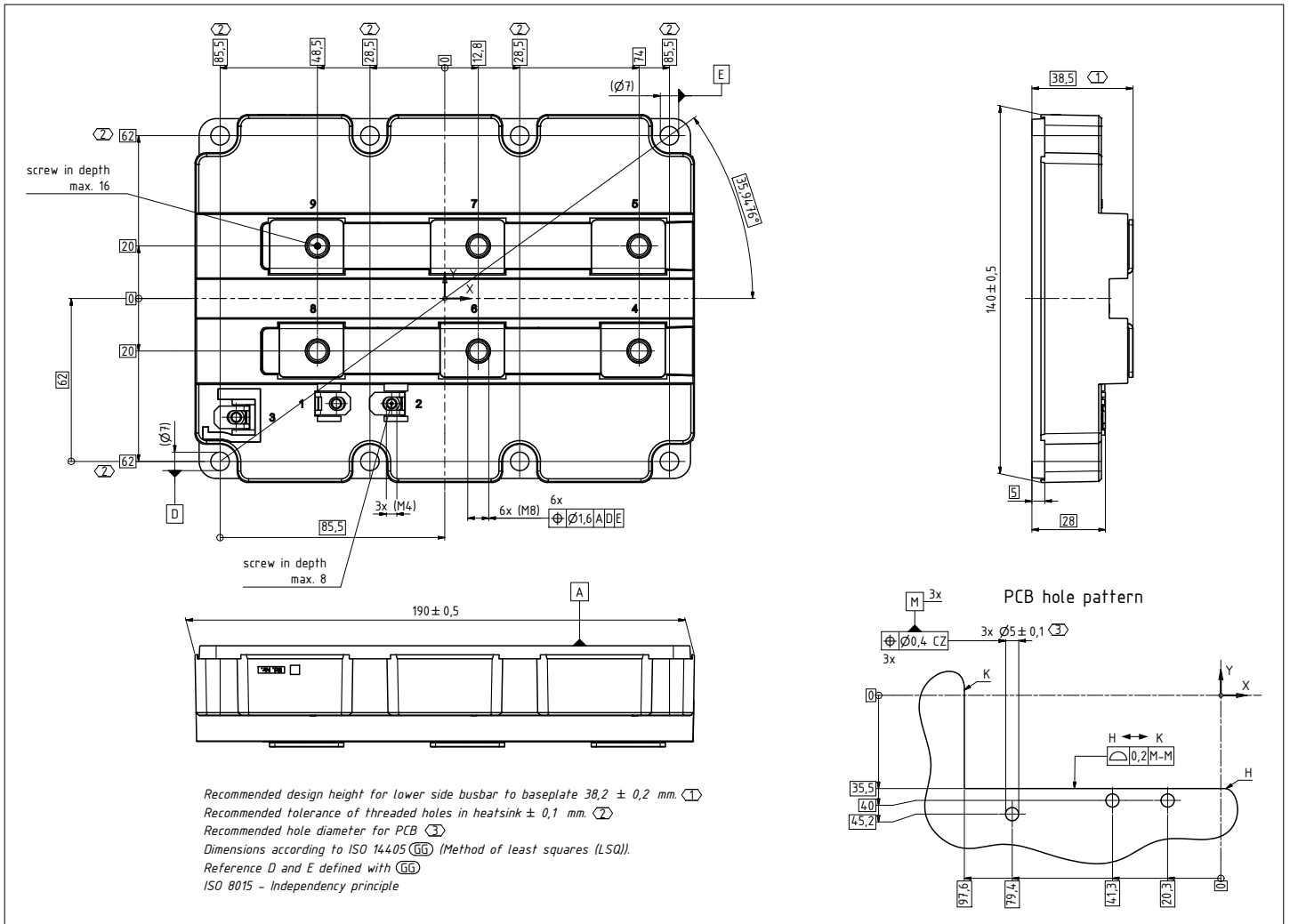

Figure 2

## 7 Module label code

Module label code			
Code format	Data Matrix	Barcode Code128	
Encoding	ASCII text	Code Set A	
Symbol size	16x16	23 digits	
Standard	IEC24720 and IEC16022	IEC8859-1	
Code content	Content	Digit	Example
	Module serial number	1 - 5	71549
	Module material number	6 - 11	142846
	Production order number	12 - 19	55054991
	Date code (production year)	20 - 21	15
	Date code (production week)	22 - 23	30
Example	 		
	71549142846550549911530		71549142846550549911530

Figure 3

## Revision history

Document revision	Date of release	Description of changes
0.20	2021-03-25	
1.00	2021-04-16	Final
1.10	2021-10-20	Final datasheet
1.20	2021-10-26	Final datasheet
1.30	2023-09-29	Final datasheet

## Trademarks

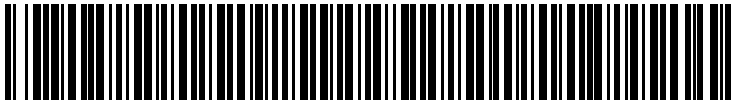
All referenced product or service names and trademarks are the property of their respective owners.

**Edition 2023-09-29**

**Published by**

**Infineon Technologies AG**

**81726 Munich, Germany**

**© 2023 Infineon Technologies AG**

**All Rights Reserved.**

**Do you have a question about any aspect of this document?**

**Email: [erratum@infineon.com](mailto:erratum@infineon.com)**

**Document reference**

**IFX-ABA749-005**

## Important notice

The information given in this document shall in no event be regarded as a guarantee of conditions or characteristics ("Beschaffheitsgarantie").

With respect to any examples, hints or any typical values stated herein and/or any information regarding the application of the product, Infineon Technologies hereby disclaims any and all warranties and liabilities of any kind, including without limitation warranties of non-infringement of intellectual property rights of any third party.

In addition, any information given in this document is subject to customer's compliance with its obligations stated in this document and any applicable legal requirements, norms and standards concerning customer's products and any use of the product of Infineon Technologies in customer's applications.

The data contained in this document is exclusively intended for technically trained staff. It is the responsibility of customer's technical departments to evaluate the suitability of the product for the intended application and the completeness of the product information given in this document with respect to such application.

Please note that this product is not qualified according to the AEC Q100 or AEC Q101 documents of the Automotive Electronics Council.

## Warnings

Due to technical requirements products may contain dangerous substances. For information on the types in question please contact your nearest Infineon Technologies office.

Except as otherwise explicitly approved by Infineon Technologies in a written document signed by authorized representatives of Infineon Technologies, Infineon Technologies' products may not be used in any applications where a failure of the product or any consequences of the use thereof can reasonably be expected to result in personal injury.