

IHM-B モジュール トレンチ/フィールドストップ IGBT4 and エミッターコントロール diode内蔵
IHM-B module with Trench/Fieldstop IGBT4 and Emitter Controlled diode

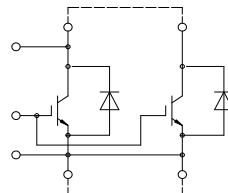

external connection
(to be done)

$V_{CES} = 1700V$
 $I_{C\ nom} = 1600A / I_{CRM} = 3200A$

一般応用

- 共振型インバータアプリケーション
- ハイパワーコンバータ
- 電鉄駆動
- 風力タービン

Typical Applications

- Resonant inverter applications
- High power converters
- Traction drives
- Wind turbines

電気的特性

- 拡張された動作温度 $T_{vj\ op}$
- 低 V_{CEsat} 飽和電圧
- $T_{vj\ op} = 150^{\circ}C$

Electrical Features

- Extended operating temperature $T_{vj\ op}$
- Low V_{CEsat}
- $T_{vj\ op} = 150^{\circ}C$

機械的特性

- 4 kV AC 1分 絶縁耐圧
- サーマルサイクル耐量を増加するAlSiCベースプレート
- CTI(比較トラッキング指数) >400のモジュールパッケージ
- 長い縁面/空間距離
- 高いパワー/サーマルサイクル耐量
- 高いパワー密度
- IHM Bハウジング

Mechanical Features

- 4 kV AC 1min insulation
- AlSiC base plate for increased thermal cycling capability
- Package with CTI > 400
- High creepage and clearance distances
- High power and thermal cycling capability
- High power density
- IHM B housing

Module Label Code

Barcode Code 128



DMX - Code



Content of the Code

| Content of the Code | Digit |
|----------------------------|---------|
| Module Serial Number | 1 - 5 |
| Module Material Number | 6 - 11 |
| Production Order Number | 12 - 19 |
| Datecode (Production Year) | 20 - 21 |
| Datecode (Production Week) | 22 - 23 |

| | | |
|-----------------|---------------------------------|----------------------|
| prepared by: WB | date of publication: 2016-01-18 | |
| approved by: IB | revision: V3.1 | UL approved (E83335) |



IGBT- インバータ / IGBT, Inverter
最大定格 / Maximum Rated Values

| | | | | |
|--|---|-------------------|-------|----|
| コレクタ・エミッタ間電圧 Collector-emitter voltage | $T_{vj} = 25^{\circ}\text{C}$ | V_{CES} | 1700 | V |
| 連続DCコレクタ電流 Continuous DC collector current | $T_C = 100^{\circ}\text{C}, T_{vj\max} = 175^{\circ}\text{C}$ | $I_{C\text{nom}}$ | 1600 | A |
| 繰り返しピークコレクタ電流 Repetitive peak collector current | $t_P = 1\text{ms}$ | I_{CRM} | 3200 | A |
| トータル損失 Total power dissipation | $T_C = 25^{\circ}\text{C}, T_{vj\max} = 175^{\circ}\text{C}$ | P_{tot} | 10,5 | kW |
| ゲート・エミッタ間ピーク電圧 Gate-emitter peak voltage | | V_{GES} | +/-20 | V |

電気的特性 / Characteristic Values

| | | | min. | typ. | max. | |
|---|---|---|--------------------|----------------------|------|---|
| コレクタ・エミッタ間飽和電圧 Collector-emitter saturation voltage | $I_C = 1600\text{A}, V_{GE} = 15\text{V}$ $I_C = 1600\text{A}, V_{GE} = 15\text{V}$ $I_C = 1600\text{A}, V_{GE} = 15\text{V}$ | $T_{vj} = 25^{\circ}\text{C}$ $T_{vj} = 125^{\circ}\text{C}$ $T_{vj} = 150^{\circ}\text{C}$ | $V_{CE\text{sat}}$ | 1,90 2,30 2,40 | 2,25 | V V V |
| ゲート・エミッタ間しきい値電圧 Gate threshold voltage | $I_C = 64,0\text{mA}, V_{CE} = V_{GE}, T_{vj} = 25^{\circ}\text{C}$ | | V_{GEth} | 5,20 | 5,80 | 6,40 V |
| ゲート電荷量 Gate charge | $V_{GE} = -15\text{V} \dots +15\text{V}$ | | Q_G | 17,0 | | μC |
| 内蔵ゲート抵抗 Internal gate resistor | $T_{vj} = 25^{\circ}\text{C}$ | | R_{Gint} | 0,97 | | Ω |
| 入力容量 Input capacitance | $f = 1\text{MHz}, T_{vj} = 25^{\circ}\text{C}, V_{CE} = 25\text{V}, V_{GE} = 0\text{V}$ | | C_{ies} | 130 | | nF |
| 帰還容量 Reverse transfer capacitance | $f = 1\text{MHz}, T_{vj} = 25^{\circ}\text{C}, V_{CE} = 25\text{V}, V_{GE} = 0\text{V}$ | | C_{res} | 4,20 | | nF |
| コレクタ・エミッタ間遮断電流 Collector-emitter cut-off current | $V_{CE} = 1700\text{V}, V_{GE} = 0\text{V}, T_{vj} = 25^{\circ}\text{C}$ | | I_{CES} | | 5,0 | mA |
| ゲート・エミッタ間漏れ電流 Gate-emitter leakage current | $V_{CE} = 0\text{V}, V_{GE} = 20\text{V}, T_{vj} = 25^{\circ}\text{C}$ | | I_{GES} | | 400 | nA |
| ターンオン遅れ時間 (誘導負荷) Turn-on delay time, inductive load | $I_C = 1600\text{A}, V_{CE} = 900\text{V}$ $V_{GE} = \pm 15\text{V}$ $R_{Gon} = 0,82\ \Omega$ | $T_{vj} = 25^{\circ}\text{C}$ $T_{vj} = 125^{\circ}\text{C}$ $T_{vj} = 150^{\circ}\text{C}$ | t_{don} | 0,47 0,53 0,54 | | μs μs μs |
| ターンオン上昇時間 (誘導負荷) Rise time, inductive load | $I_C = 1600\text{A}, V_{CE} = 900\text{V}$ $V_{GE} = \pm 15\text{V}$ $R_{Gon} = 0,82\ \Omega$ | $T_{vj} = 25^{\circ}\text{C}$ $T_{vj} = 125^{\circ}\text{C}$ $T_{vj} = 150^{\circ}\text{C}$ | t_r | 0,15 0,15 0,15 | | μs μs μs |
| ターンオフ遅れ時間 (誘導負荷) Turn-off delay time, inductive load | $I_C = 1600\text{A}, V_{CE} = 900\text{V}$ $V_{GE} = \pm 15\text{V}$ $R_{Goff} = 0,6\ \Omega$ | $T_{vj} = 25^{\circ}\text{C}$ $T_{vj} = 125^{\circ}\text{C}$ $T_{vj} = 150^{\circ}\text{C}$ | t_{doff} | 1,05 1,20 1,20 | | μs μs μs |
| ターンオフ下降時間 (誘導負荷) Fall time, inductive load | $I_C = 1600\text{A}, V_{CE} = 900\text{V}$ $V_{GE} = \pm 15\text{V}$ $R_{Goff} = 0,6\ \Omega$ | $T_{vj} = 25^{\circ}\text{C}$ $T_{vj} = 125^{\circ}\text{C}$ $T_{vj} = 150^{\circ}\text{C}$ | t_f | 0,30 0,46 0,51 | | μs μs μs |
| ターンオンスイッチング損失 Turn-on energy loss per pulse | $I_C = 1600\text{A}, V_{CE} = 900\text{V}, L_S = 50\text{nH}$ $V_{GE} = \pm 15\text{V}, di/dt = 9900\text{A}/\mu\text{s} (T_{vj} = 150^{\circ}\text{C})$ $R_{Gon} = 0,82\ \Omega$ | $T_{vj} = 25^{\circ}\text{C}$ $T_{vj} = 125^{\circ}\text{C}$ $T_{vj} = 150^{\circ}\text{C}$ | E_{on} | 275 415 440 | | mJ mJ mJ |
| ターンオフスイッチング損失 Turn-off energy loss per pulse | $I_C = 1600\text{A}, V_{CE} = 900\text{V}, L_S = 50\text{nH}$ $V_{GE} = \pm 15\text{V}, du/dt = 3250\text{V}/\mu\text{s} (T_{vj} = 150^{\circ}\text{C})$ $R_{Goff} = 0,6\ \Omega$ | $T_{vj} = 25^{\circ}\text{C}$ $T_{vj} = 125^{\circ}\text{C}$ $T_{vj} = 150^{\circ}\text{C}$ | E_{off} | 420 570 600 | | mJ mJ mJ |
| 短絡電流 SC data | $V_{GE} \leq 15\text{V}, V_{CC} = 1000\text{V}$ $V_{CE\text{max}} = V_{CES} - L_{SCE} \cdot di/dt$ $t_P \leq 10\ \mu\text{s}, T_{vj} = 150^{\circ}\text{C}$ | | I_{SC} | 7500 | | A |
| ジャンクション・ケース間熱抵抗 Thermal resistance, junction to case | IGBT部 (1素子当り) / per IGBT | | R_{thJC} | | 11,6 | K/kW |
| ケース・ヒートシンク間熱抵抗 Thermal resistance, case to heatsink | IGBT部 (1素子当り) / per IGBT $\lambda_{\text{Paste}} = 1\text{W}/(\text{m}\cdot\text{K})$ / $\lambda_{\text{grease}} = 1\text{W}/(\text{m}\cdot\text{K})$ | | R_{thCH} | 15,0 | | K/kW |
| 動作温度 Temperature under switching conditions | | | $T_{vj\text{op}}$ | -40 | 150 | $^{\circ}\text{C}$ |

| | |
|-----------------|---------------------------------|
| prepared by: WB | date of publication: 2016-01-18 |
| approved by: IB | revision: V3.1 |



Diode、インバータ / Diode, Inverter
最大定格 / Maximum Rated Values

| | | | | |
|--|--|----------------------|------------|--|
| ピーク繰返し逆電圧 Repetitive peak reverse voltage | $T_{vj} = 25^{\circ}\text{C}$ | V_{RRM} | 1700 | V |
| 連続DC電流 Continuous DC forward current | | I_F | 1600 | A |
| ピーク繰返し順電流 Repetitive peak forward current | $t_P = 1 \text{ ms}$ | I_{FRM} | 3200 | A |
| 電流二乗時間積 I^2t - value | $V_R = 0 \text{ V}, t_P = 10 \text{ ms}, T_{vj} = 125^{\circ}\text{C}$ $V_R = 0 \text{ V}, t_P = 10 \text{ ms}, T_{vj} = 150^{\circ}\text{C}$ | I^2t | 465 440 | kA^2s kA^2s |
| 最大損失 Maximum power dissipation | $T_{vj} = 125^{\circ}\text{C}$ | P_{RQM} | 1600 | kW |
| 最小ターンオン時間 Minimum turn-on time | | $t_{on \text{ min}}$ | 10,0 | μs |

電気的特性 / Characteristic Values

| | | | min. | typ. | max. | |
|---|---|---|---------------------|----------------------|------|---|
| 順電圧 Forward voltage | $I_F = 1600 \text{ A}, V_{GE} = 0 \text{ V}$ $I_F = 1600 \text{ A}, V_{GE} = 0 \text{ V}$ $I_F = 1600 \text{ A}, V_{GE} = 0 \text{ V}$ | $T_{vj} = 25^{\circ}\text{C}$ $T_{vj} = 125^{\circ}\text{C}$ $T_{vj} = 150^{\circ}\text{C}$ | V_F | 1,80 1,90 1,95 | 2,20 | V V V |
| ピーク逆回復電流 Peak reverse recovery current | $I_F = 1600 \text{ A}, -di_F/dt = 9900 \text{ A}/\mu\text{s} (T_{vj}=150^{\circ}\text{C})$ $V_R = 900 \text{ V}$ $V_{GE} = -15 \text{ V}$ | $T_{vj} = 25^{\circ}\text{C}$ $T_{vj} = 125^{\circ}\text{C}$ $T_{vj} = 150^{\circ}\text{C}$ | I_{RM} | 1800 2050 2050 | | A A A |
| 逆回復電荷量 Recovered charge | $I_F = 1600 \text{ A}, -di_F/dt = 9900 \text{ A}/\mu\text{s} (T_{vj}=150^{\circ}\text{C})$ $V_R = 900 \text{ V}$ $V_{GE} = -15 \text{ V}$ | $T_{vj} = 25^{\circ}\text{C}$ $T_{vj} = 125^{\circ}\text{C}$ $T_{vj} = 150^{\circ}\text{C}$ | Q_r | 390 680 765 | | μC μC μC |
| 逆回復損失 Reverse recovery energy | $I_F = 1600 \text{ A}, -di_F/dt = 9900 \text{ A}/\mu\text{s} (T_{vj}=150^{\circ}\text{C})$ $V_R = 900 \text{ V}$ $V_{GE} = -15 \text{ V}$ | $T_{vj} = 25^{\circ}\text{C}$ $T_{vj} = 125^{\circ}\text{C}$ $T_{vj} = 150^{\circ}\text{C}$ | E_{rec} | 270 465 530 | | mJ mJ mJ |
| ジャンクション・ケース間熱抵抗 Thermal resistance, junction to case | /Diode (1 素子当り) / per diode | | R_{thJC} | | 19,6 | K/kW |
| ケース・ヒートシンク間熱抵抗 Thermal resistance, case to heatsink | /Diode (1 素子当り) / per diode $\lambda_{\text{Paste}} = 1 \text{ W}/(\text{m}\cdot\text{K})$ / $\lambda_{\text{grease}} = 1 \text{ W}/(\text{m}\cdot\text{K})$ | | R_{thCH} | 16,0 | | K/kW |
| 動作温度 Temperature under switching conditions | | | $T_{vj \text{ op}}$ | -40 | 150 | $^{\circ}\text{C}$ |

| | |
|-----------------|---------------------------------|
| prepared by: WB | date of publication: 2016-01-18 |
| approved by: IB | revision: V3.1 |



モジュール / Module

| | | | | | |
|---|--|---------------------|--------------|--------|--------------|
| 絶縁耐圧 Isolation test voltage | RMS, f = 50 Hz, t = 1 min. | V _{ISOL} | 4,0 | | kV |
| ベースプレート材質 Material of module baseplate | | | AISiC | | |
| 沿面距離 Creepage distance | 連絡方法 - ヒートシンク / terminal to heatsink 連絡方法 - 連絡方法 / terminal to terminal | | 32,2 32,2 | | mm |
| 空間距離 Clearance | 連絡方法 - ヒートシンク / terminal to heatsink 連絡方法 - 連絡方法 / terminal to terminal | | 19,1 19,1 | | mm |
| 相対トラッキング指数 Comperative tracking index | | CTI | > 400 | | |
| | | | min. | typ. | max. |
| 内部インダクタンス Stray inductance module | | L _{sCE} | | 9,0 | nH |
| パワーターミナル・チップ間抵抗 Module lead resistance, terminals - chip | T _c = 25°C, /スイッチ / per switch | R _{CC+EE'} | | 0,15 | mΩ |
| 保存温度 Storage temperature | | T _{stg} | -40 | | 150 °C |
| 取り付けネジ締め付けトルク Mounting torque for modul mounting | 取り付けネジ M6 適切なアプリケーションノートによるマウンティング Screw M6 - Mounting according to valid application note | M | 4,25 | | 5,75 Nm |
| 主端子ネジ締め付けトルク Terminal connection torque | 取り付けネジ M4 適切なアプリケーションノートによるマウンティング Screw M4 - Mounting according to valid application note 取り付けネジ M8 適切なアプリケーションノートによるマウンティング Screw M8 - Mounting according to valid application note | M | 1,8 8,0 | - - | 2,1 10 Nm |
| 質量 Weight | | G | | 800 | g |

| | |
|-----------------|---------------------------------|
| prepared by: WB | date of publication: 2016-01-18 |
| approved by: IB | revision: V3.1 |



出力特性 IGBT- インバータ (Typical)
output characteristic IGBT, Inverter (typical)

$I_C = f(V_{CE})$
 $V_{GE} = 15\text{ V}$

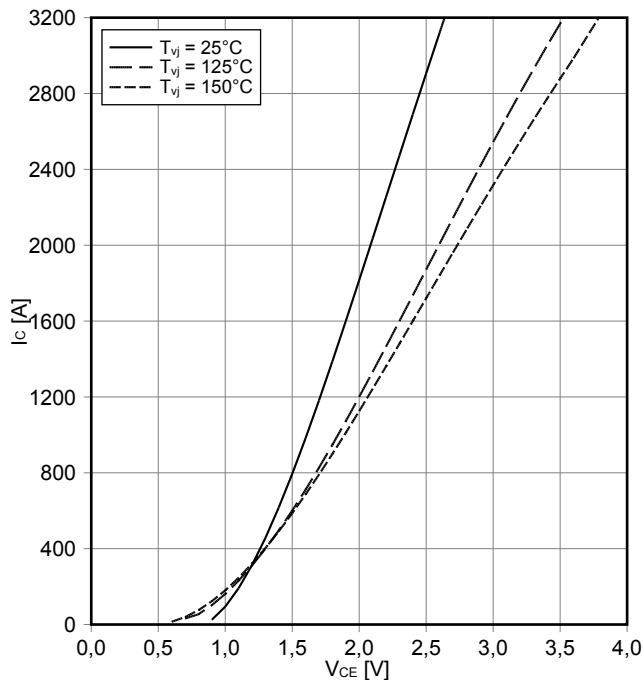

出力特性 IGBT- インバータ (Typical)
output characteristic IGBT, Inverter (typical)

$I_C = f(V_{CE})$
 $T_{vj} = 150^\circ\text{C}$

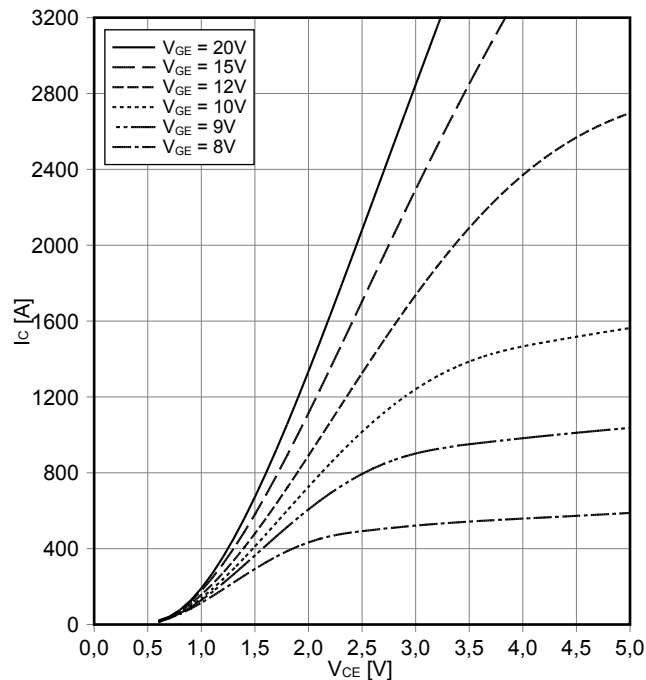

伝達特性 IGBT- インバータ (Typical)
transfer characteristic IGBT, Inverter (typical)

$I_C = f(V_{GE})$
 $V_{CE} = 20\text{ V}$

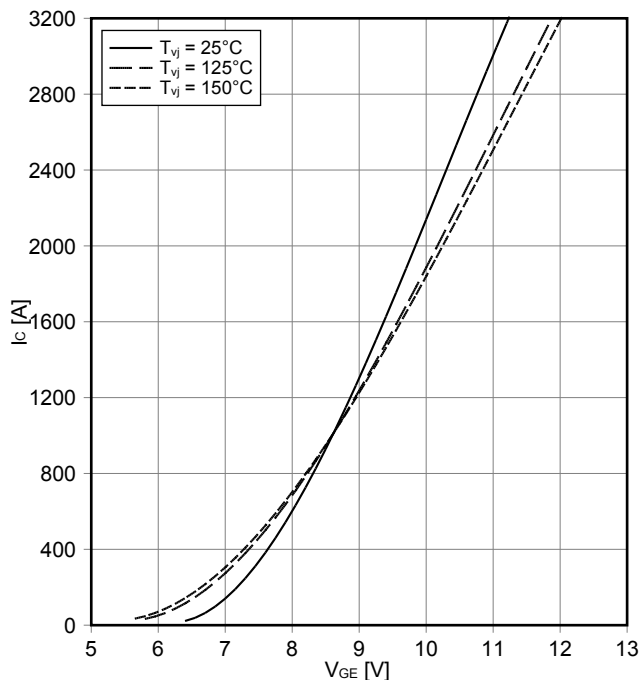

スイッチング損失 IGBT- インバータ (Typical)
switching losses IGBT, Inverter (typical)

$E_{on} = f(I_C)$, $E_{off} = f(I_C)$
 $V_{GE} = \pm 15\text{ V}$, $R_{Gon} = 0.82\ \Omega$, $R_{Goff} = 0.6\ \Omega$, $V_{CE} = 900\text{ V}$

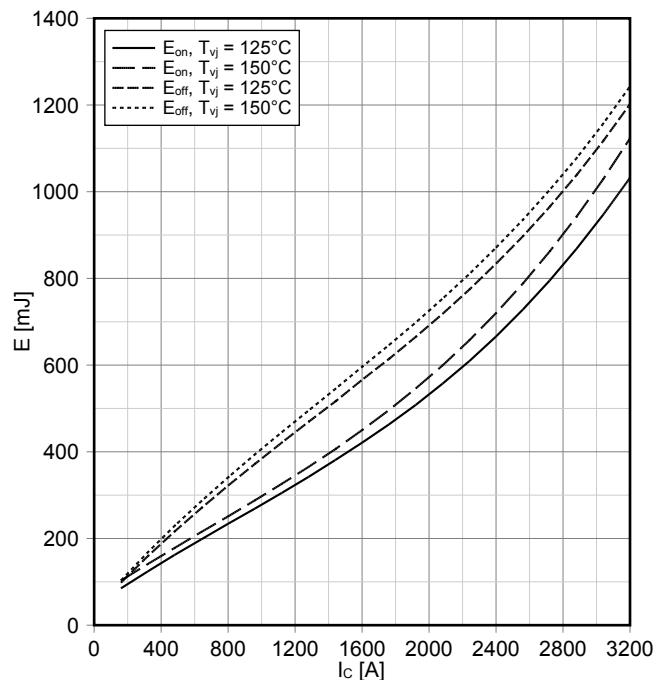

| | |
|-----------------|---------------------------------|
| prepared by: WB | date of publication: 2016-01-18 |
| approved by: IB | revision: V3.1 |



スイッチング損失 IGBT- インバータ (Typical)
switching losses IGBT, Inverter (typical)

$E_{on} = f(R_G), E_{off} = f(R_G)$
 $V_{GE} = \pm 15 V, I_C = 1600 A, V_{CE} = 900 V$

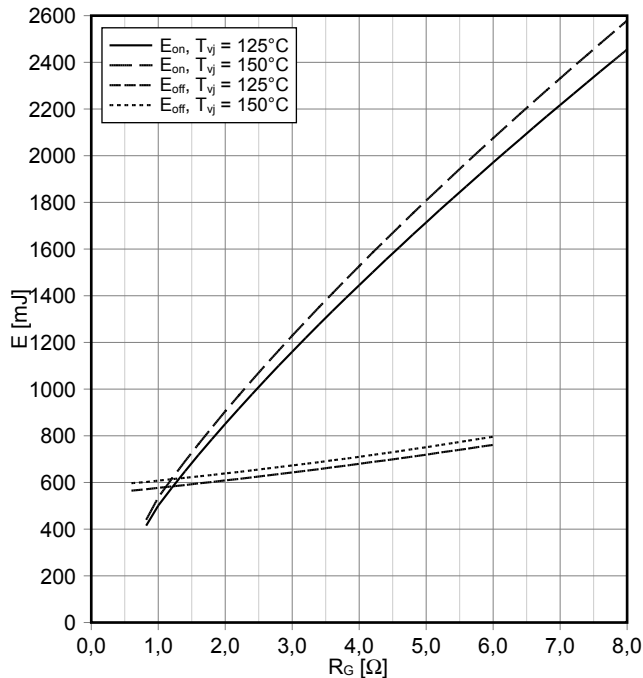

過渡熱インピーダンス IGBT- インバータ
transient thermal impedance IGBT, Inverter

$Z_{thJC} = f(t)$

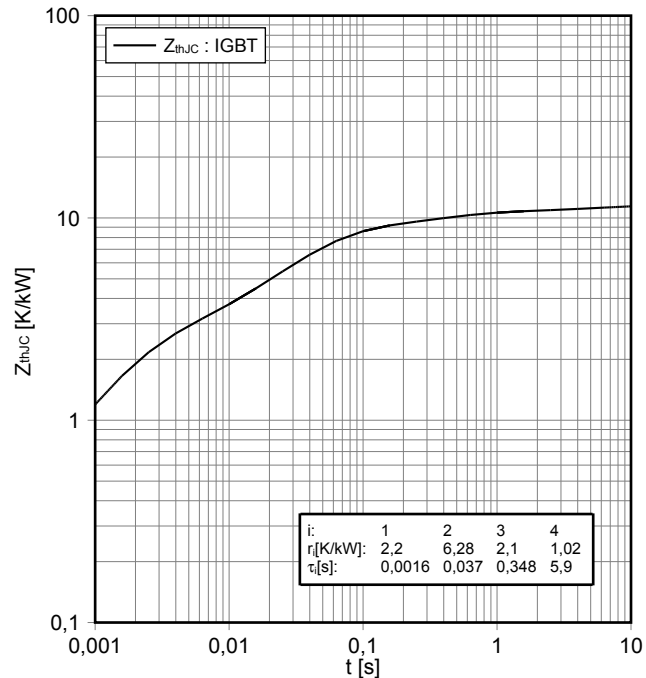

逆バイアス安全動作領域 IGBT- インバータ (RBSOA)
reverse bias safe operating area IGBT, Inverter (RBSOA)

$I_C = f(V_{CE})$
 $V_{GE} = \pm 15 V, R_{Goff} = 0.6 \Omega, T_{vj} = 150^\circ C$

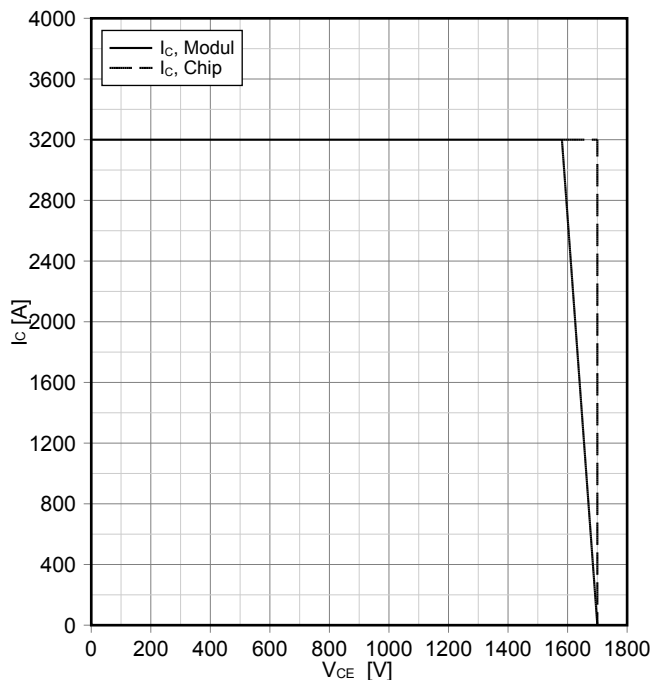

順電圧特性 Diode、インバータ (typical)
forward characteristic of Diode, Inverter (typical)

$I_F = f(V_F)$

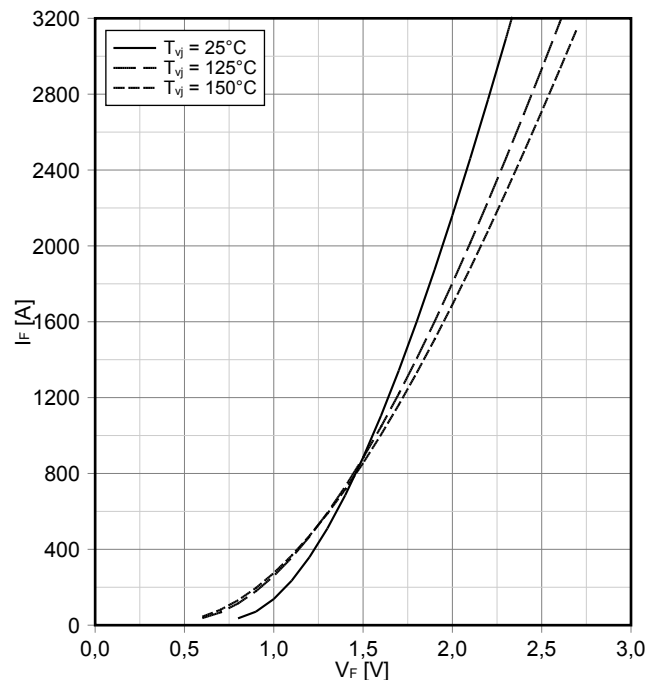

| | |
|-----------------|---------------------------------|
| prepared by: WB | date of publication: 2016-01-18 |
| approved by: IB | revision: V3.1 |



IGBT-モジュール
IGBT-Module

FZ1600R17HP4_B21

スイッチング損失 Diode、インバータ (Typical)
switching losses Diode, Inverter (typical)

$E_{rec} = f(I_F)$
 $R_{Gon} = 0.82 \Omega, V_{CE} = 900 V$

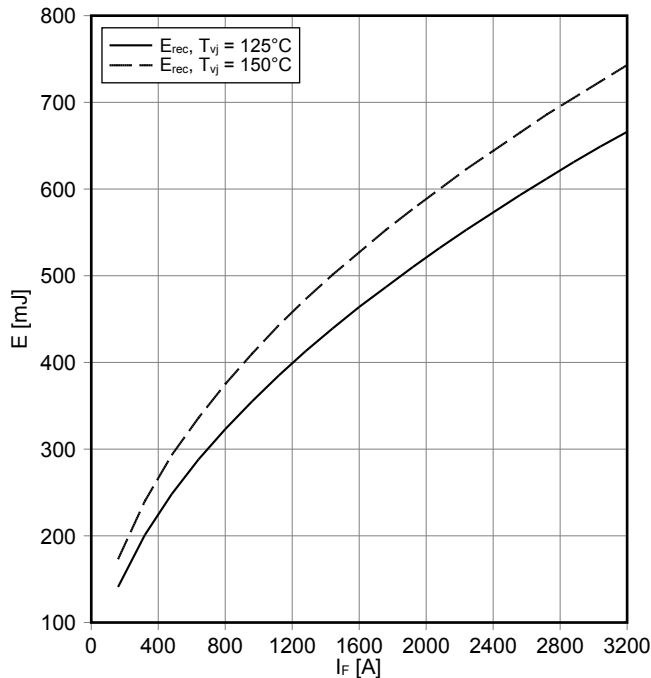

スイッチング損失 Diode、インバータ (Typical)
switching losses Diode, Inverter (typical)

$E_{rec} = f(R_G)$
 $I_F = 1600 A, V_{CE} = 900 V$

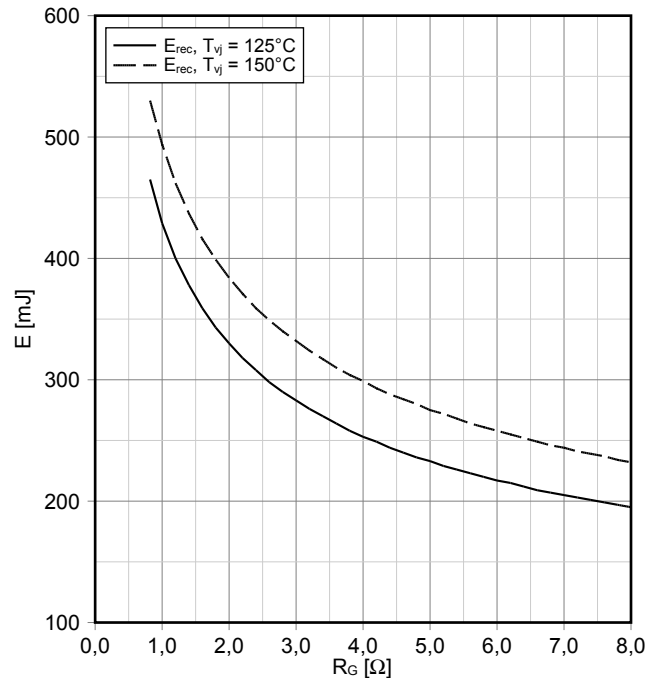

過渡熱インピーダンス Diode、インバータ
transient thermal impedance Diode, Inverter

$Z_{thJC} = f(t)$

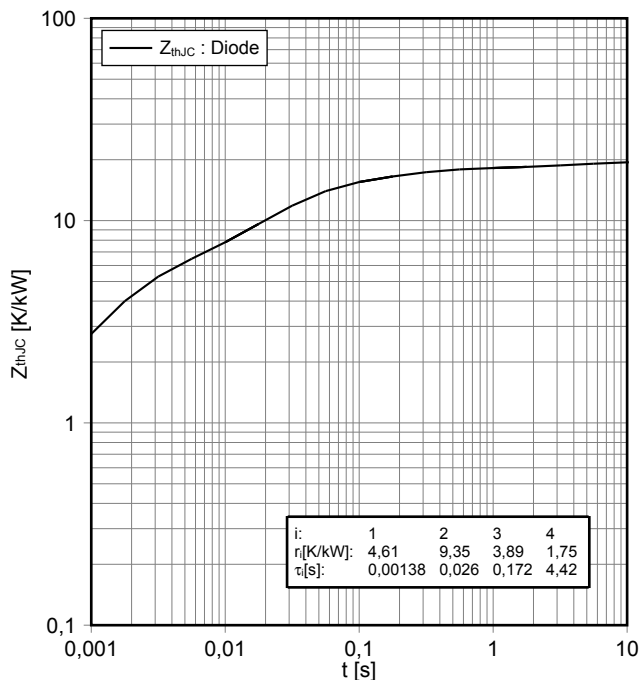

安全動作領域 Diode、インバータ (SOA)
safe operation area Diode, Inverter (SOA)

$I_R = f(V_R)$
 $T_{vj} = 150^\circ C$

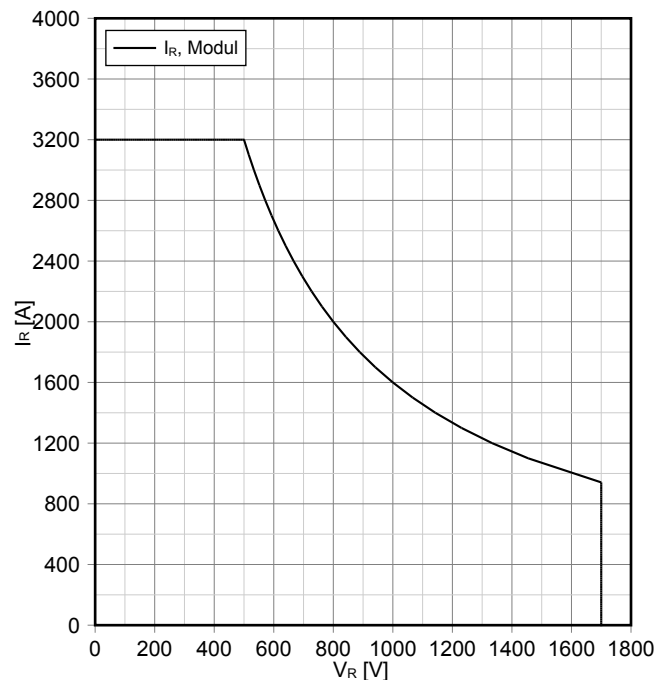

| | |
|-----------------|---------------------------------|
| prepared by: WB | date of publication: 2016-01-18 |
| approved by: IB | revision: V3.1 |

回路図 / Circuit diagram

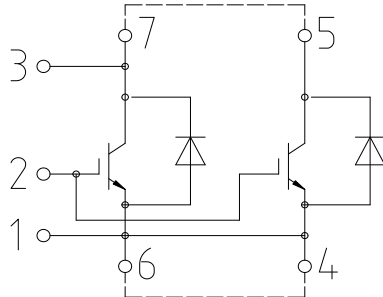

external connection
(to be done)

パッケージ概要 / Package outlines

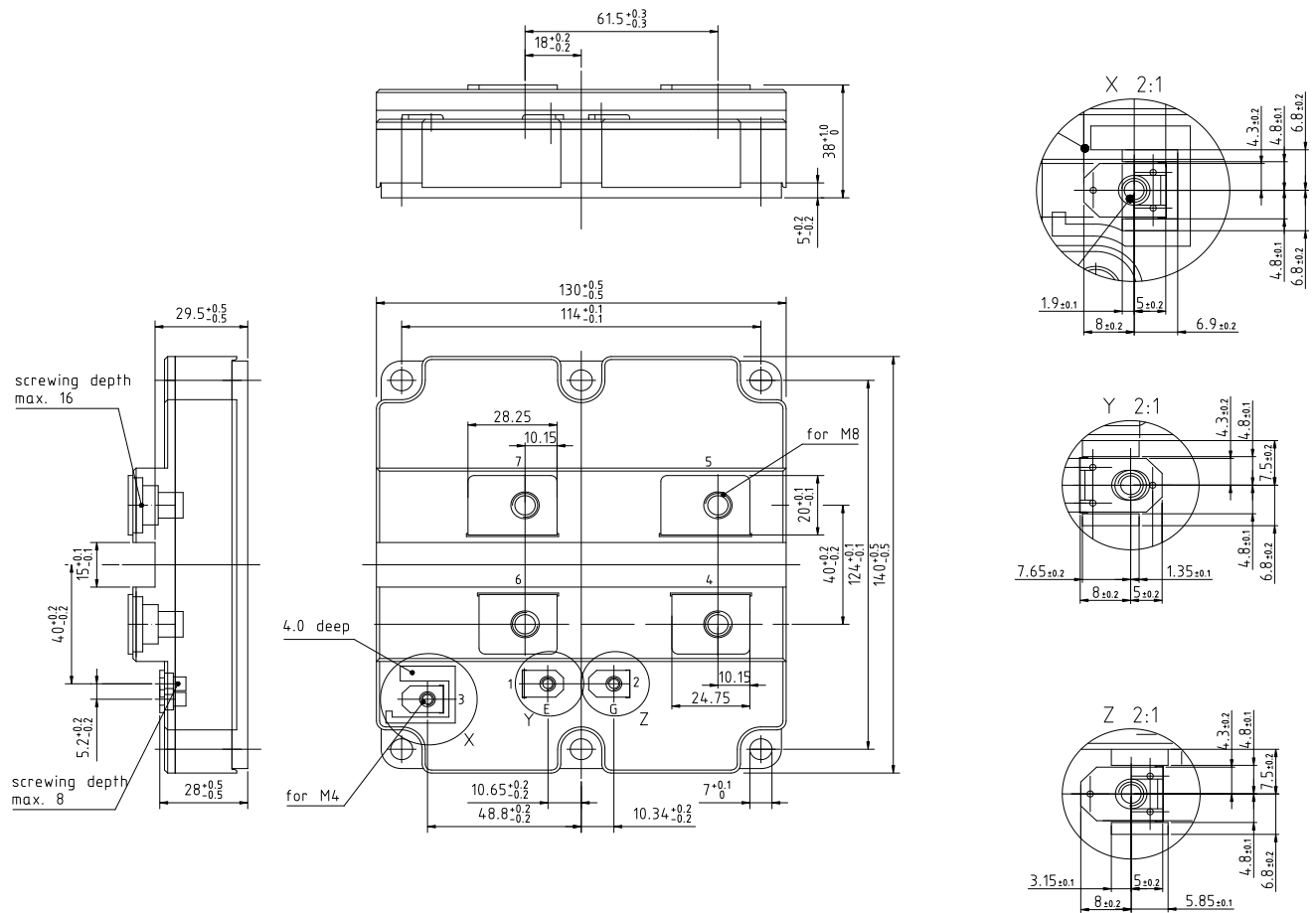

| | |
|-----------------|---------------------------------|
| prepared by: WB | date of publication: 2016-01-18 |
| approved by: IB | revision: V3.1 |



Published by
Infineon Technologies AG
81726 München, Germany
© Infineon Technologies AG 2015.
All Rights Reserved.

この日本語は、あくまで参考訳となりますので、正式はデータシートに記載されている英文の物となります。

重要事項

本文書に記載された情報は、いかなる場合も、条件または特性の保証とみなされるものではありません（「品質の保証」）。本文に記載された一切の事例、手引き、もしくは一般的価値、および / または本製品の用途に関する一切の情報に関し、インフィニオンテクノロジーズ（以下、「インフィニオン」）はここに、第三者の知的所有権の不侵害の保証を含むがこれに限らず、あらゆる種類の一切の保証および責任を否定いたします。

さらに、本文書に記載された一切の情報は、お客様の用途におけるお客様の製品およびインフィニオン製品の一切の使用に関し、本文書に記載された義務ならびに一切の関連する法的要件、規範、および基準をお客様が遵守することを条件としています。

本文書に含まれるデータは、技術的訓練を受けた従業員のみを対象としています。本製品の対象用途への適合性、およびこれら用途に関連して本文書に記載された製品情報の完全性についての評価は、お客様の技術部門の責任にて実施してください。

本製品、技術、納品条件、および価格についての詳しい情報は、インフィニオンの最寄りの営業所までお問い合わせください（www.infineon.com）。

警告事項

技術的要件に伴い、製品には危険物質が含まれる可能性があります。当該種別の詳細については、インフィニオンの最寄りの営業所までお問い合わせください。

インフィニオンの正式代表者が署名した書面を通じ、インフィニオンによる明示の承認が存在する場合を除き、インフィニオンの製品は、当該製品の障害またはその使用に関する一切の結果が、合理的に人的傷害を招く恐れのある一切の用途に使用することはできないこと予めご了承ください

Terms & Conditions of usage

IMPORTANT NOTICE

The information given in this document shall in no event be regarded as a guarantee of conditions or characteristics ("Beschaffenheitsgarantie"). With respect to any examples, hints or any typical values stated herein and/or any information regarding the application of the product, Infineon Technologies hereby disclaims any and all warranties and liabilities of any kind, including without limitation warranties of non-infringement of intellectual property rights of any third party.

In addition, any information given in this document is subject to customer's compliance with its obligations stated in this document and any applicable legal requirements, norms and standards concerning customer's products and any use of the product of Infineon Technologies in customer's applications.

The data contained in this document is exclusively intended for technically trained staff. It is the responsibility of customer's technical departments to evaluate the suitability of the product for the intended application and the completeness of the product information given in this document with respect to such application.

For further information on the product, technology, delivery terms and conditions and prices please contact your nearest Infineon Technologies office (www.infineon.com).

WARNINGS

Due to technical requirements products may contain dangerous substances. For information on the types in question please contact your nearest Infineon Technologies office.

Except as otherwise explicitly approved by Infineon Technologies in a written document signed by authorized representatives of Infineon Technologies, Infineon Technologies' products may not be used in any applications where a failure of the product or any consequences of the use thereof can reasonably be expected to result in personal injury.

| | |
|-----------------|---------------------------------|
| prepared by: WB | date of publication: 2016-01-18 |
| approved by: IB | revision: V3.1 |