

HybridPACK™ Drive Module

FS770R08A6P2LB

Final Data Sheet

V3.0, 2019-05-28

Automotive High Power

1 Features / Description

HybridPACK™ Drive module with EDT2 IGBT and Diode

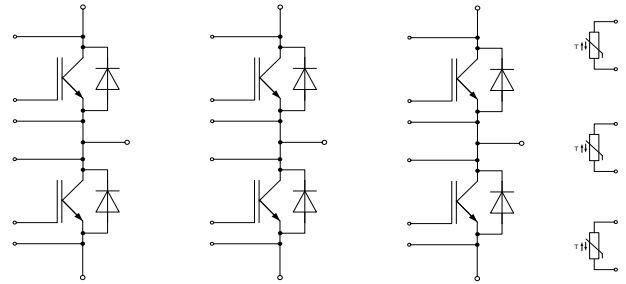
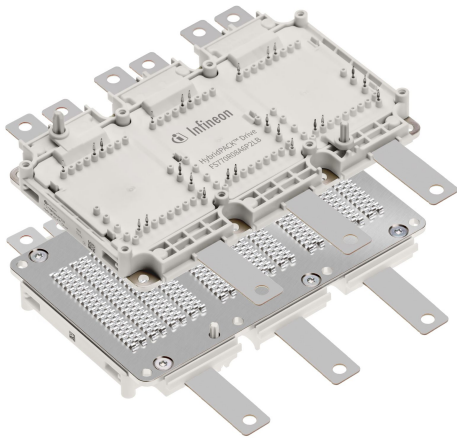

$V_{CES} = 750 \text{ V}$
 $I_C = 770 \text{ A}$

Typical Applications

- Automotive Applications
- Hybrid Electrical Vehicles (H)EV
- Motor Drives
- Commercial Agriculture Vehicles

Electrical Features

- Blocking voltage 750V
- Low V_{CEsat}
- Low Switching Losses
- Low Q_g and Cr_{ss}
- Low Inductive Design
- $T_{vj\ op} = 150^\circ\text{C}$
- Short-time extended Operation Temperature
 $T_{vj\ op} = 175^\circ\text{C}$

Mechanical Features

- 4.2kV DC 1sec Insulation
- High Creepage and Clearance Distances
- Compact design
- High Power Density
- Direct Cooled Base Plate with Ribbon Bonds
- Guiding elements for PCB and cooler assembly
- Integrated NTC temperature sensor
- PressFIT Contact Technology
- RoHS compliant
- UL 94 V0 module frame

Description

The HybridPACK™ Drive is a very compact six-pack module optimized for hybrid and electric vehicles. The product FS770R08A6P2FB comes with a flat baseplate and bonded cooling structure and is a 750V/770A module derivate within the HybridPACK Drive family. The power module implements the new EDT2 IGBT generation, which is an automotive Micro-Pattern Trench-Field-Stop cell design optimized for electric drive train applications. The chipset has benchmark current density combined with short circuit ruggedness and increased blocking voltage for reliable inverter operation under harsh environmental conditions. The EDT2 IGBTs also show excellent light load power losses, which helps to improve system efficiency over a real driving cycle. The EDT2 IGBT was optimized for applications with switching frequencies in the range of 10 kHz.

The new HybridPACK™ Drive power module family comes with mechanical guiding elements supporting easy assembly processes for customers. Furthermore, the press-fit pins for the signal terminals avoid additional time consuming selective solder processes, which provides cost savings on system level and increases system reliability. The products in the HybridPACK Drive family with flat baseplate FS660R08A6P2FB; PinFin baseplate FS820R08A6P2B as well as the FS770R08A6P2B derivate allow a very cost effective scaling for different inverter power levels at a minimum inverter design effort.

Product Name	Ordering Code
FS770R08A6P2LB	SP001706976

2 IGBT, Inverter

2.1 Maximum Rated Values

Parameter	Conditions	Symbol	Value	Unit
Collector-emitter voltage	$T_{vj} = 25^{\circ}\text{C}$	V_{CES}	750	V
Implemented collector current		I_{CN}	770	A
Continuous DC collector current	$T_F = 75^{\circ}\text{C}$, $T_{vj\max} = 175^{\circ}\text{C}$	$I_{C\text{nom}}$	450 ¹⁾	A
Repetitive peak collector current	$t_p = 1\text{ ms}$	I_{CRM}	1540	A
Total power dissipation	$T_F = 75^{\circ}\text{C}$, $T_{vj\max} = 175^{\circ}\text{C}$	P_{tot}	654 ¹⁾	W
Gate-emitter peak voltage		V_{GES}	+/-20	V

2.2 Characteristic Values

Parameter	Conditions	Symbol	min. typ. max.			Unit
Collector-emitter saturation voltage	$I_C = 450\text{ A}$, $V_{GE} = 15\text{ V}$	$V_{CE\text{sat}}$		1.10	1.35	V
	$I_C = 450\text{ A}$, $V_{GE} = 15\text{ V}$			1.15		
	$I_C = 450\text{ A}$, $V_{GE} = 15\text{ V}$			1.15		
	$I_C = 770\text{ A}$, $V_{GE} = 15\text{ V}$			1.28		
	$I_C = 770\text{ A}$, $V_{GE} = 15\text{ V}$			1.44		
Gate threshold voltage	$I_C = 9.60\text{ mA}$, $V_{CE} = V_{GE}$	$V_{GE\text{th}}$	4.90	5.80 4,10	6.50	V
Gate charge	$V_{GE} = -8\text{ V} \dots 15\text{ V}$, $V_{CE} = 400\text{ V}$	Q_G		4.40		μC
Internal gate resistor		$R_{G\text{int}}$		0.7		Ω
Input capacitance	$f = 1\text{ MHz}$, $V_{CE} = 50\text{ V}$, $V_{GE} = 0\text{ V}$	C_{ies}		80.0		nF
Output capacitance	$f = 1\text{ MHz}$, $V_{CE} = 50\text{ V}$, $V_{GE} = 0\text{ V}$	C_{oes}		1.00		nF
Reverse transfer capacitance	$f = 1\text{ MHz}$, $V_{CE} = 50\text{ V}$, $V_{GE} = 0\text{ V}$	C_{res}		0.30		nF
Collector-emitter cut-off current	$V_{CE} = 750\text{ V}$, $V_{GE} = 0\text{ V}$	I_{CES}		5	1.0	mA
	$V_{CE} = 750\text{ V}$, $V_{GE} = 0\text{ V}$					
Gate-emitter leakage current	$V_{CE} = 0\text{ V}$, $V_{GE} = 20\text{ V}$	I_{GES}			400	nA
Turn-on delay time, inductive load	$I_C = 450\text{ A}$, $V_{CE} = 400\text{ V}$ $V_{GE} = -8\text{ V} / +15\text{ V}$ $R_{G\text{on}} = 2.4\ \Omega$	$t_{d\text{on}}$		0.28		μs
				0.29		
				0.30		
Rise time, inductive load	$I_C = 450\text{ A}$, $V_{CE} = 400\text{ V}$ $V_{GE} = -8\text{ V} / +15\text{ V}$ $R_{G\text{on}} = 2.4\ \Omega$	t_r		0.07		μs
				0.08		
				0.08		
Turn-off delay time, inductive load	$I_C = 450\text{ A}$, $V_{CE} = 400\text{ V}$ $V_{GE} = -8\text{ V} / +15\text{ V}$ $R_{G\text{off}} = 5.1\ \Omega$	$t_{d\text{off}}$		0.94		μs
				1.05		
				1.05		
Fall time, inductive load	$I_C = 450\text{ A}$, $V_{CE} = 400\text{ V}$ $V_{GE} = -8\text{ V} / +15\text{ V}$ $R_{G\text{off}} = 5.1\ \Omega$	t_f		0.04		μs
				0.05		
				0.06		
Turn-on energy loss per pulse	$I_C = 450\text{ A}$, $V_{CE} = 400\text{ V}$, $L_S = 20\text{ nH}$ $V_{GE} = -8\text{ V} / +15\text{ V}$ $R_{G\text{on}} = 2.4\ \Omega$ $di/dt (T_{vj} 25^{\circ}\text{C}) = 5500\text{ A}/\mu\text{s}$ $di/dt (T_{vj} 150^{\circ}\text{C}) = 5000\text{ A}/\mu\text{s}$	E_{on}		13.5		mJ
				17.5		
				18.0		
Turn-off energy loss per pulse	$I_C = 450\text{ A}$, $V_{CE} = 400\text{ V}$, $L_S = 20\text{ nH}$ $V_{GE} = -8\text{ V} / +15\text{ V}$ $R_{G\text{off}} = 5.1\ \Omega$ $dv/dt (T_{vj} 25^{\circ}\text{C}) = 3100\text{ V}/\mu\text{s}$ $dv/dt (T_{vj} 150^{\circ}\text{C}) = 2500\text{ V}/\mu\text{s}$	E_{off}		23.5		mJ
				29.0		
				30.0		
SC data	$V_{GE} \leq 15\text{ V}$, $V_{CC} = 400\text{ V}$ $V_{CE\text{max}} = V_{CES} - L_{SCE} \cdot di/dt$	$t_p \leq 6\ \mu\text{s}$, $T_{vj} = 25^{\circ}\text{C}$ $t_p \leq 3\ \mu\text{s}$, $T_{vj} = 175^{\circ}\text{C}$	I_{SC}	4800 3900		A
Thermal resistance, junction to cooling fluid	per IGBT; $\Delta V/\Delta t = 10\text{ dm}^3/\text{min}$, $T_F = 75^{\circ}\text{C}$	R_{thJF}		0.130 ²⁾	0.153 ²⁾	K/W
Temperature under switching conditions	t_{op} continuous for 10s within a period of 30s, occurrence maximum 3000 times over lifetime	$T_{vj\text{op}}$	-40 150		150 ³⁾ 175	$^{\circ}\text{C}$

¹⁾ Verified by characterization / design not by test.

²⁾ For cooler design see application note AN-HPD-ASSEMBLY. Cooling fluid 50% water / 50% ethylenglycol.

³⁾ For $T_{vj\text{op}} > 150^{\circ}\text{C}$: Baseplate temperature has to be limited to 125°C .

3 Diode, Inverter

3.1 Maximum Rated Values

Parameter	Conditions	Symbol	Value	Unit
Repetitive peak reverse voltage	$T_{vj} = 25^{\circ}\text{C}$	V_{RRM}	750	V
Implemented forward current		I_{FN}	770	A
Continuous DC forward current		I_F	450 ¹⁾	A
Repetitive peak forward current	$t_p = 1 \text{ ms}$	I_{FRM}	1540	A
I^2t - value	$V_R = 0 \text{ V}, t_p = 10 \text{ ms}, T_{vj} = 150^{\circ}\text{C}$ $V_R = 0 \text{ V}, t_p = 10 \text{ ms}, T_{vj} = 175^{\circ}\text{C}$	I^2t	19000 16000	A^2s A^2s

3.2 Characteristic Values

Parameter	Conditions	Symbol	min. typ. max.			Unit	
Forward voltage	$I_F = 450 \text{ A}, V_{GE} = 0 \text{ V}$	V_F			1.45	V	
	$I_F = 450 \text{ A}, V_{GE} = 0 \text{ V}$						1.30
	$I_F = 450 \text{ A}, V_{GE} = 0 \text{ V}$						1.25
	$I_F = 770 \text{ A}, V_{GE} = 0 \text{ V}$						1.65
Peak reverse recovery current	$I_F = 450 \text{ A}, -di_F/dt = 5000 \text{ A}/\mu\text{s} (T_{vj} = 150^{\circ}\text{C})$	I_{RM}			250	A	
	$V_R = 400 \text{ V}$ $V_{GE} = -8 \text{ V}$						350 370
Recovered charge	$I_F = 450 \text{ A}, -di_F/dt = 5000 \text{ A}/\mu\text{s} (T_{vj} = 150^{\circ}\text{C})$	Q_r			20.0	μC	
	$V_R = 400 \text{ V}$ $V_{GE} = -8 \text{ V}$						40.0 45.0
Reverse recovery energy	$I_F = 450 \text{ A}, -di_F/dt = 5000 \text{ A}/\mu\text{s} (T_{vj} = 150^{\circ}\text{C})$	E_{rec}			7.00	mJ	
	$V_R = 400 \text{ V}$ $V_{GE} = -8 \text{ V}$						13.0 15.0
Thermal resistance, junction to cooling fluid	per diode; $\Delta V/\Delta t = 10 \text{ dm}^3/\text{min}, T_F = 75^{\circ}\text{C}$	R_{thJF}			0.185 ²⁾	0.217 ²⁾	K/W
Temperature under switching conditions	t_{op} continuous for 10s within a period of 30s, occurrence maximum 3000 times over lifetime	$T_{vj op}$			-40 150	150 ³⁾ 175	$^{\circ}\text{C}$

4 NTC-Thermistor

Parameter	Conditions	Symbol	min. typ. max.			Unit
Rated resistance	$T_C = 25^{\circ}\text{C}$	R_{25}		5.00		$\text{k}\Omega$
Deviation of R100	$T_C = 100^{\circ}\text{C}, R_{100} = 493 \Omega$	$\Delta R/R$	-5		-5	%
Power dissipation	$T_C = 25^{\circ}\text{C}$	P_{25}			20.0	mW
B-value	$R_2 = R_{25} \exp [B_{25/50}(1/T_2 - 1/(298,15 \text{ K}))]$	$B_{25/50}$		3375		K
B-value	$R_2 = R_{25} \exp [B_{25/80}(1/T_2 - 1/(298,15 \text{ K}))]$	$B_{25/80}$		3411		K
B-value	$R_2 = R_{25} \exp [B_{25/100}(1/T_2 - 1/(298,15 \text{ K}))]$	$B_{25/100}$		3433		K

Specification according to the valid application note.

¹⁾ Verified by characterization / design not by test.

²⁾ For cooler design see application note AN-HPD-ASSEMBLY. Cooling fluid 50% water / 50% ethylenglycol.

³⁾ For $T_{vjop} > 150^{\circ}\text{C}$: Baseplate temperature has to be limited to 125°C .

5 Module

Parameter	Conditions	Symbol	Value			Unit
Isolation test voltage	RMS, f = 0 Hz, t = 1 sec	V _{ISOL}	4.2			kV
Maximum RMS module terminal current	T _F = 75°C, T _{Ct} = 105°C	I _{RMS}	500 ¹⁾			A
Material of module baseplate			Cu+Nj ²⁾			
Internal isolation	basic insulation (class 1, IEC 61140)		Al ₂ O ₃ ³⁾			
Creepage distance	terminal to heatsink terminal to terminal	d _{Creep}	9.0 9.0			mm
Clearance	terminal to heatsink terminal to terminal	d _{Clear}	4.5 4.5			mm
Comperative tracking index		CTI	> 200			
			min.	typ.	max.	
Pressure drop in cooling circuit	ΔV/Δt = 10.0 dm ³ /min; T _F = 75°C	Δp		87 ⁴⁾		mbar
Maximum pressure in cooling circuit	T _{baseplate} < 40°C T _{baseplate} > 40°C (relative pressure)	p			3.0 ⁵⁾ 2.5	bar
Stray inductance module		L _{sCE}	8.0			nH
Module lead resistance, terminals - chip	T _F = 25 °C, per switch	R _{CC'+EE'}	0.75			mΩ
Storage temperature		T _{stg}	-40		125	°C
Mounting torque for modul mounting	Screw M4 baseplate to heatsink Screw EJOT Delta PCB to frame	M	1.80 0.45	2.00 0.50	2.20 0.55 ⁶⁾	Nm
Weight		G	605			g

¹⁾ Continous, steady state. Verified by characterization / design not by test.

²⁾ Ni plated Cu baseplate.

³⁾ Improved Al₂O₃ ceramic.

⁴⁾ For cooler design see application note AN-HPD-ASSEMBLY. Cooling fluid 50% water / 50% ethylenglycol.

⁵⁾ According to application note AN-HPD-ASSEMBLY.

⁶⁾ EJOT Delta PT WN 5451 30x10. Effective mounting torque according to application note AN-HPD-ASSEMBLY

6 Characteristics Diagrams

output characteristic IGBT, Inverter (typical)

$I_C = f(V_{CE})$
 $V_{GE} = 15\text{ V}$

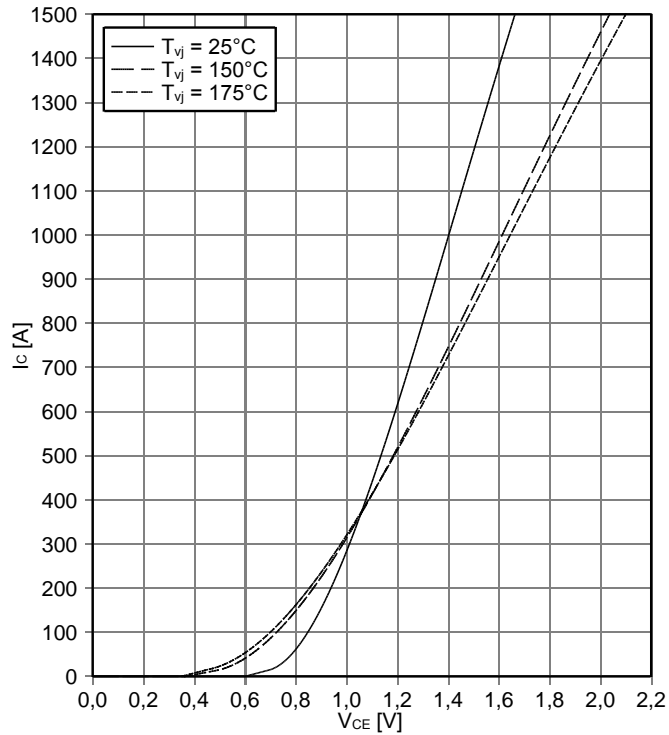

output characteristic IGBT, Inverter (typical)

$I_C = f(V_{CE})$
 $T_{vj} = 150^\circ\text{C}$

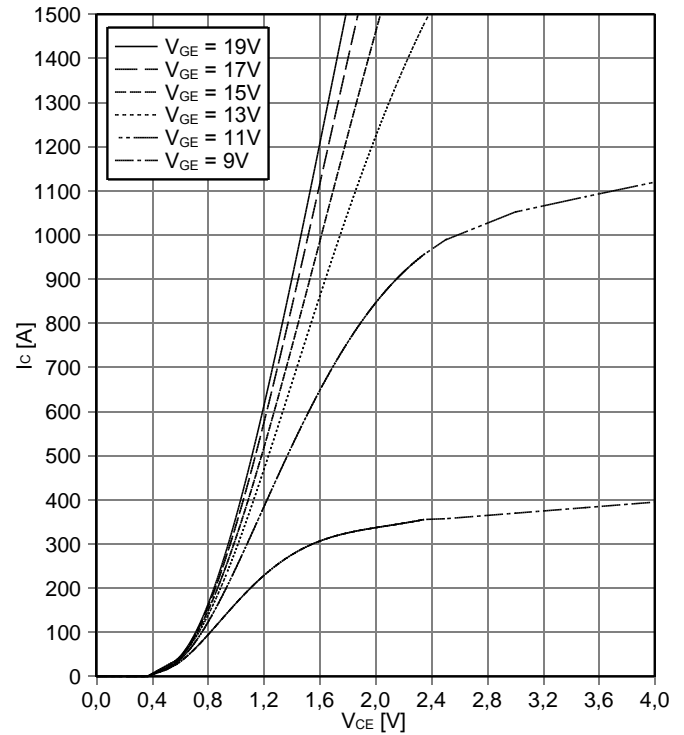

transfer characteristic IGBT, Inverter (typical)

$I_C = f(V_{GE})$
 $V_{CE} = 20\text{ V}$

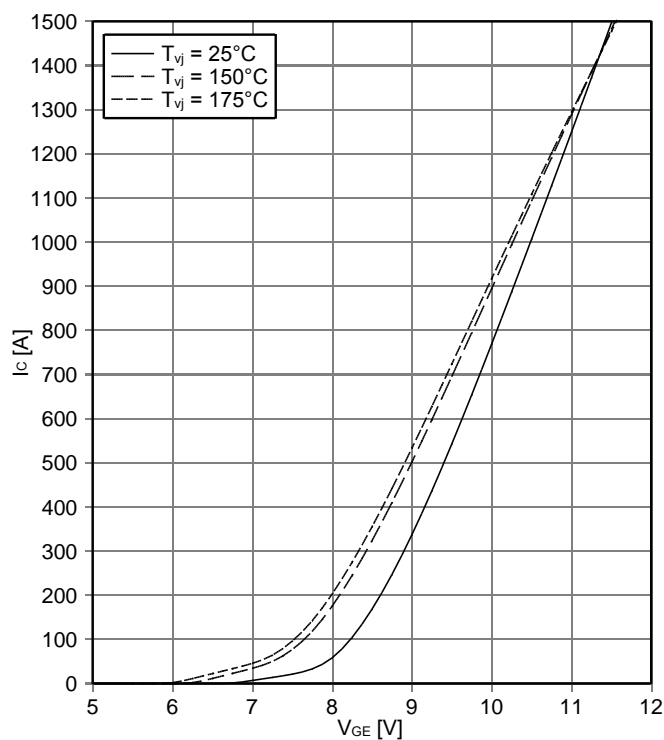

switching losses IGBT, Inverter (typical)

$E_{on} = f(I_C)$, $E_{off} = f(I_C)$
 $V_{GE} = +15\text{ V} / -8\text{ V}$, $R_{Gon} = 2.4\ \Omega$, $R_{Goff} = 5.1\ \Omega$, $V_{CE} = 400\text{ V}$

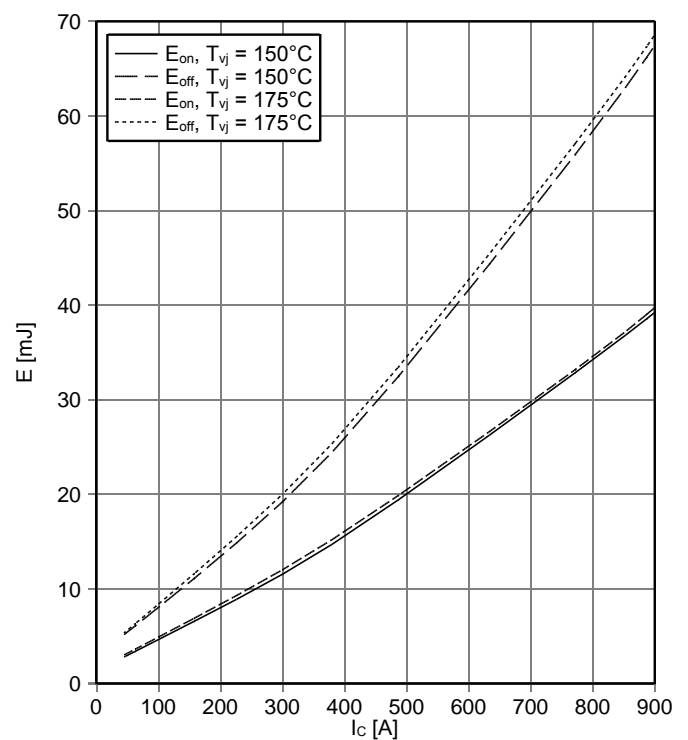

switching losses IGBT, Inverter (typical)

$E_{on} = f(R_G), E_{off} = f(R_G)$

$V_{GE} = +15V / -8V, I_C = 450 A, V_{CE} = 400 V$

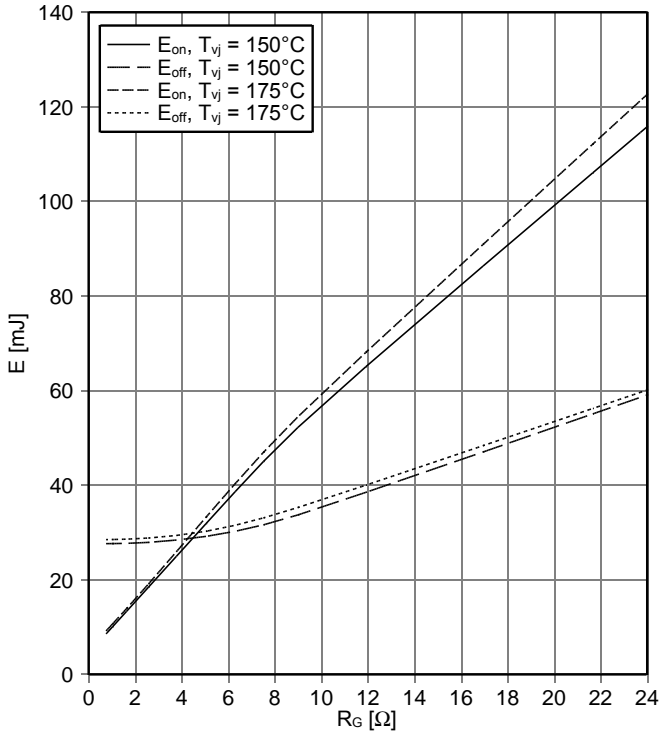

transient thermal impedance IGBT, Inverter

$Z_{thJF} = f(t)$, cooler design according to AN-HPD-ASSEMBLY

$\Delta V/\Delta t = 10 \text{ dm}^3/\text{min}; T_f = 75^\circ\text{C}; 50\% \text{ water} / 50\% \text{ ethylenglycol}$

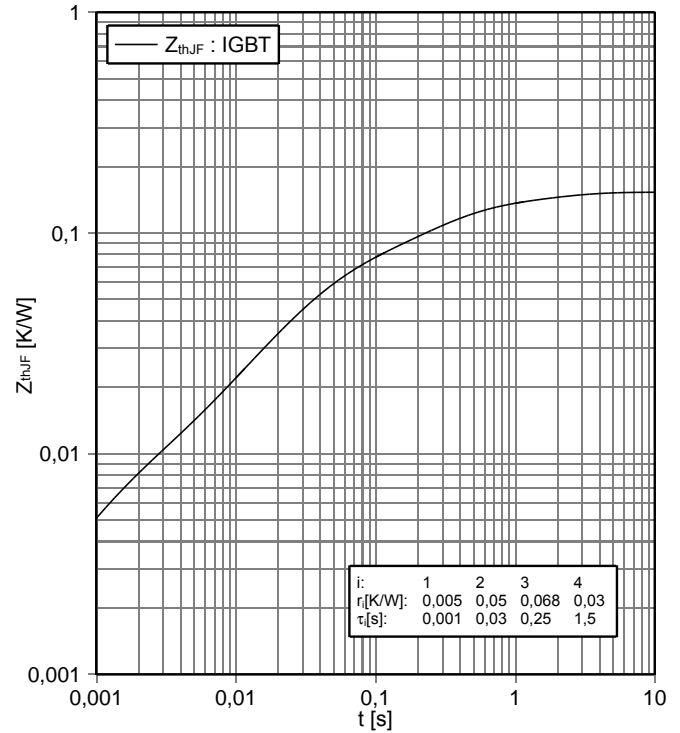

reverse bias safe operating area IGBT, Inverter (RBSOA)

$I_C = f(V_{CE})$

$V_{GE} = +15V / -8V, R_{Goff} = 5,1 \Omega, T_{vj} = 175^\circ\text{C}$

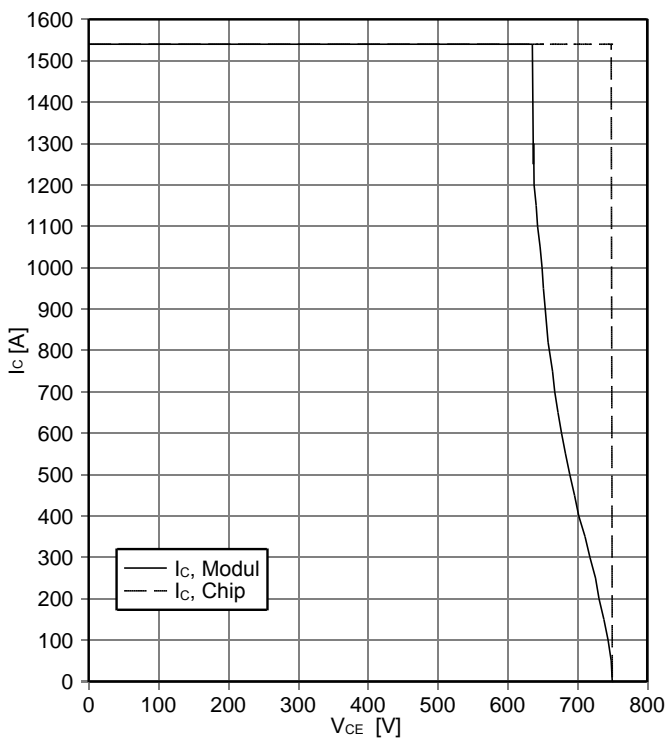

thermal impedance IGBT, Inverter

$R_{thJF} = f(\Delta V/\Delta t)$, cooler design according to AN-HPD-Assembly

$T_f = 75^\circ\text{C}; 50\% \text{ water} / 50\% \text{ ethylenglycol}$

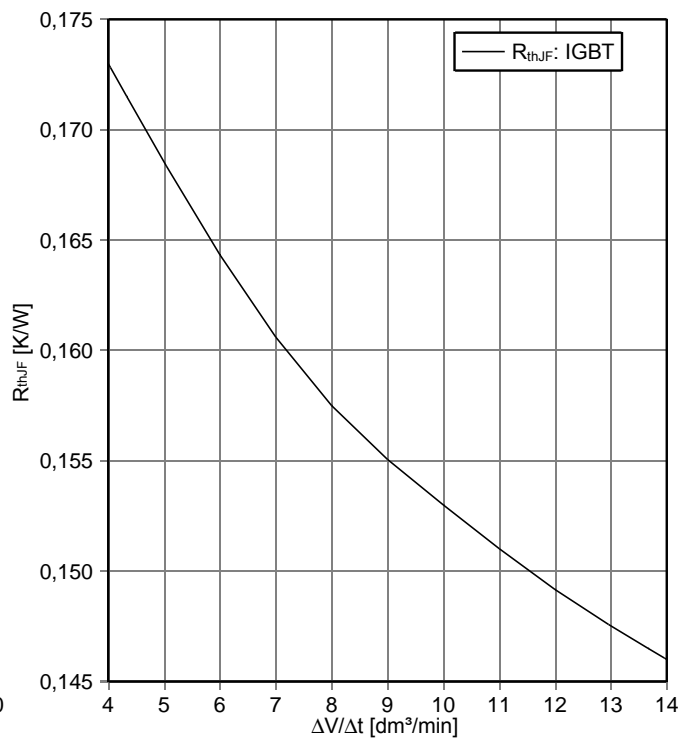

capacity characteristic IGBT, Inverter (typical)

$C = f(V_{CE})$
 $V_{GE} = 0 \text{ V}, T_{vj} = 25^\circ\text{C}, f = 1\text{MHz}$

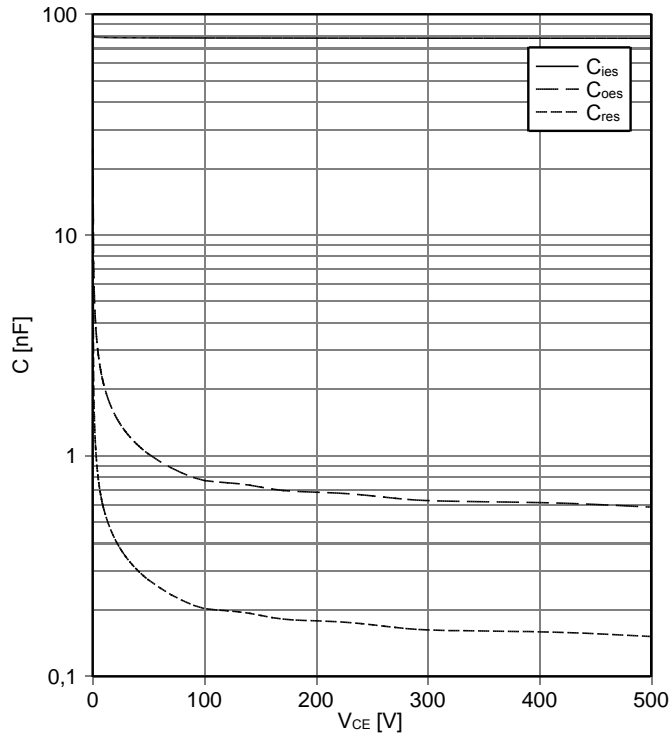

gate charge characteristic IGBT, Inverter (typical)

$V_{GE} = f(Q_G)$
 $V_{CE} = 400 \text{ V}, I_C = 450 \text{ A}, T_{vj} = 25^\circ\text{C}$

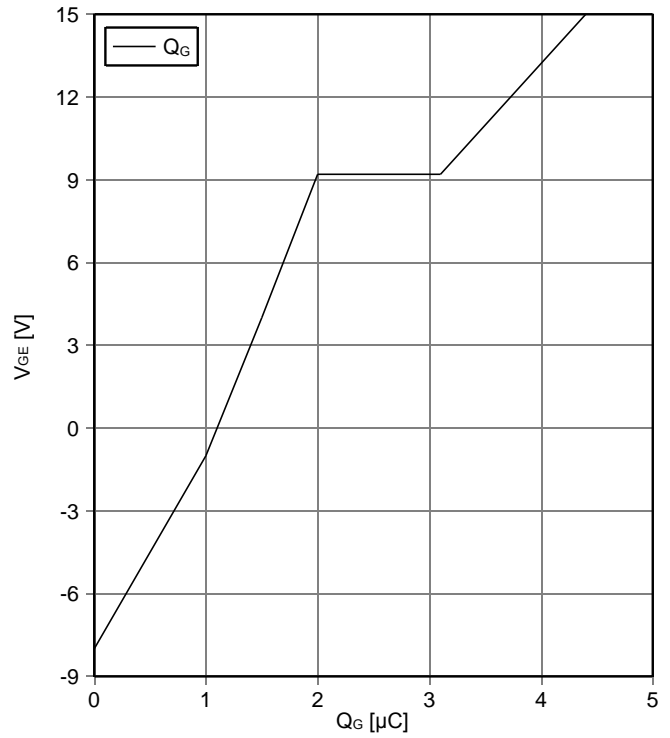

maximum allowed collector-emitter voltage

$V_{CES} = f(T_{vj})$, verified by characterization / design not by test
 $I_{CES} = 1 \text{ mA}$ for $T_{vj} \leq 25^\circ\text{C}$; $I_{CES} = 30 \text{ mA}$ for $T_{vj} > 25^\circ\text{C}$

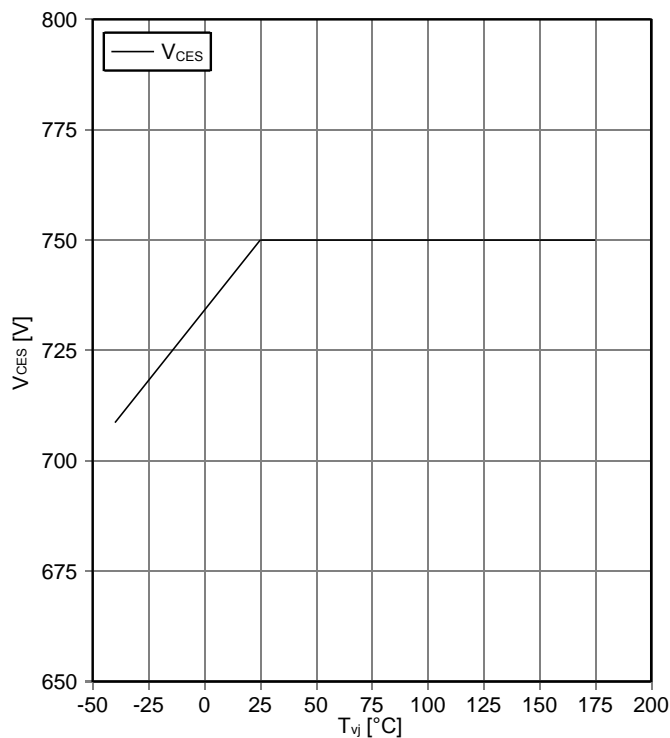

forward characteristic of Diode, Inverter (typical)

$I_F = f(V_F)$

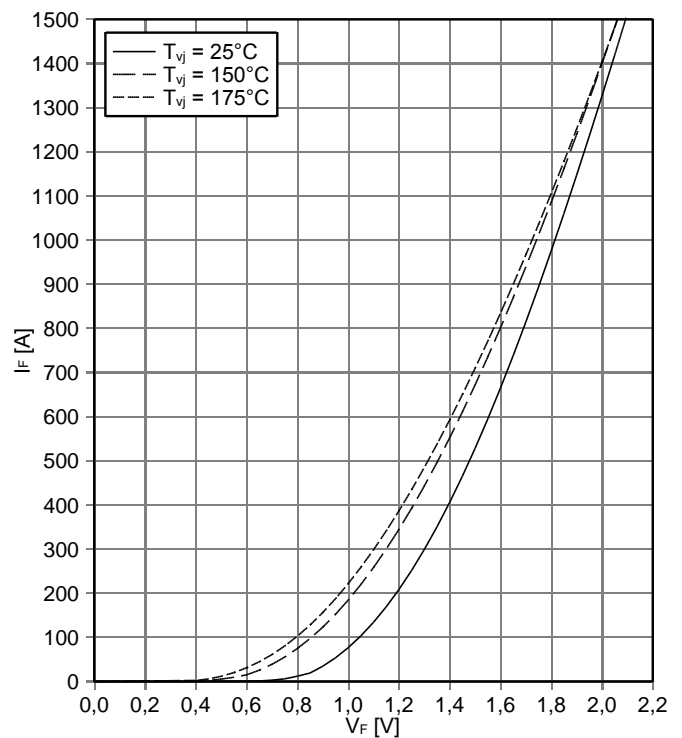

switching losses Diode, Inverter (typical)

$E_{rec} = f(I_F)$,
 $R_{Gon} = 2.4 \Omega$, $V_{CE} = 400 V$

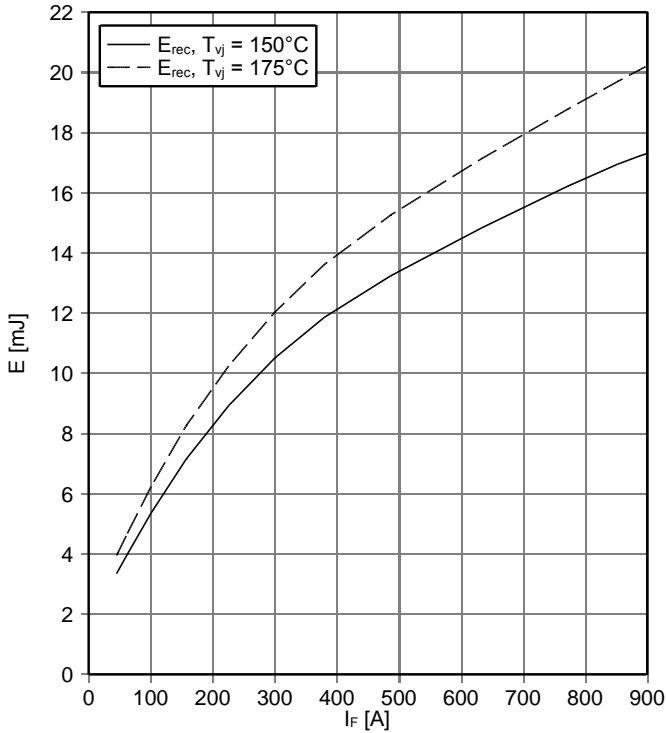

switching losses Diode, Inverter (typical)

$E_{rec} = f(R_G)$,
 $I_F = 450 A$, $V_{CE} = 400 V$

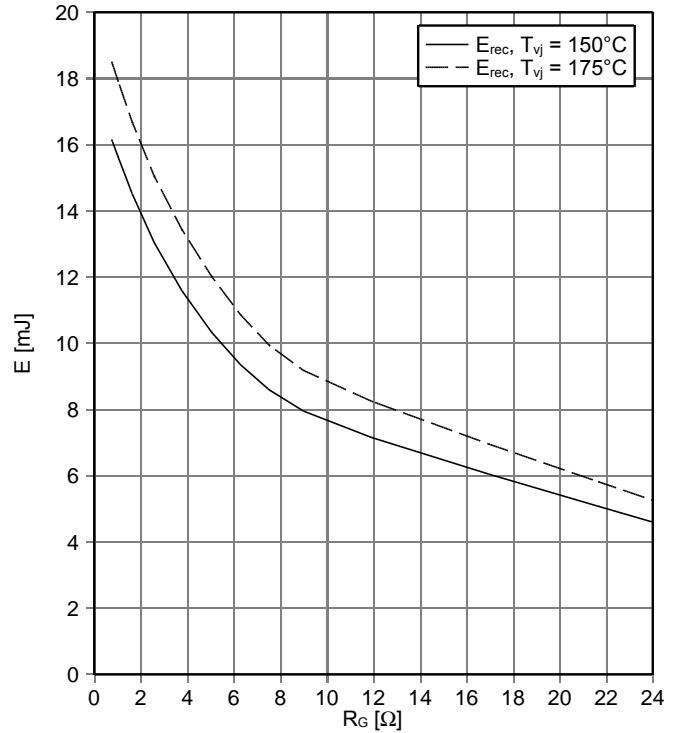

transient thermal impedance Diode, Inverter

$Z_{thJF} = f(t)$, cooler design according to AN-HPD-ASSEMBLY
 $\Delta V/\Delta t = 10 \text{ dm}^3/\text{min}$; $T_f = 75^\circ\text{C}$; 50% water / 50% ethylenglycol

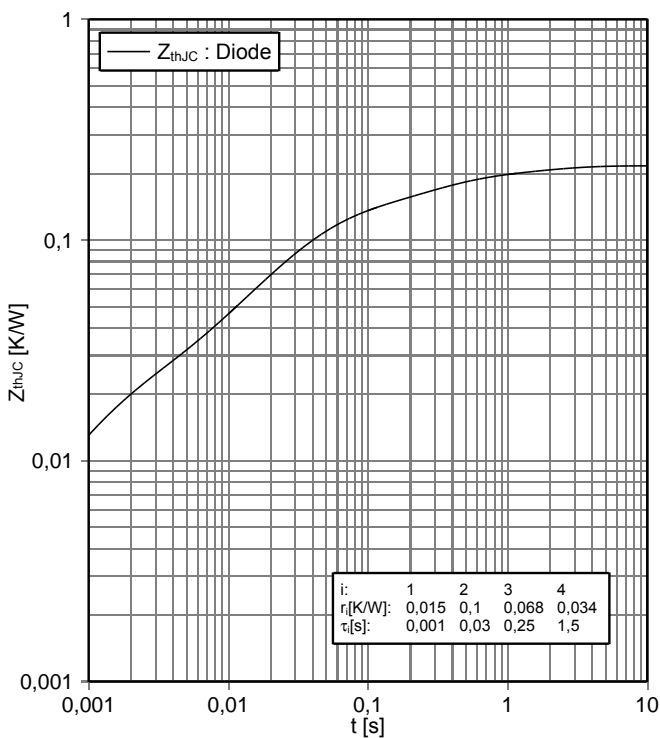

thermal impedance Diode, Inverter

$R_{thJF} = f(\Delta V/\Delta t)$, cooler design according to AN-HPD-ASSEMBLY
 $T_f = 75^\circ\text{C}$; 50% water / 50% ethylenglycol

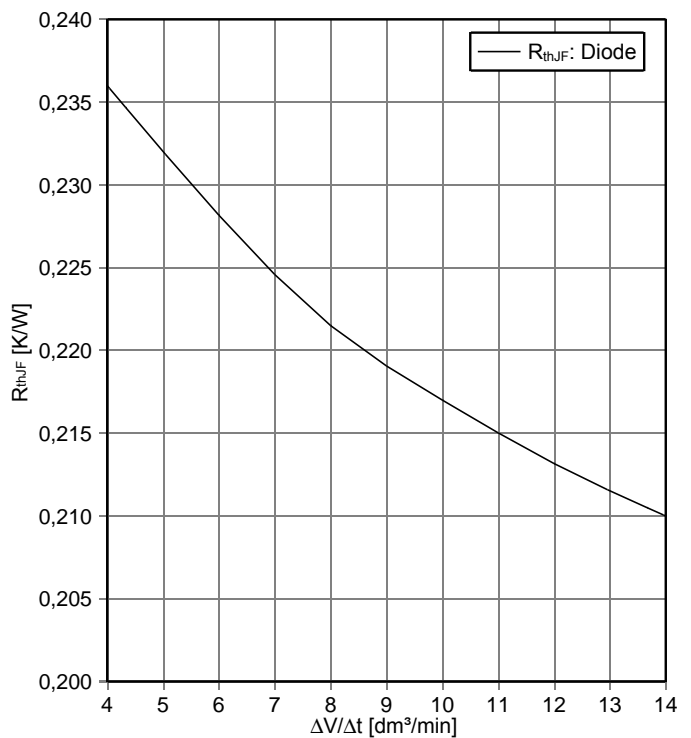

NTC-Thermistor-temperature characteristic (typical)
 $R = f(T)$

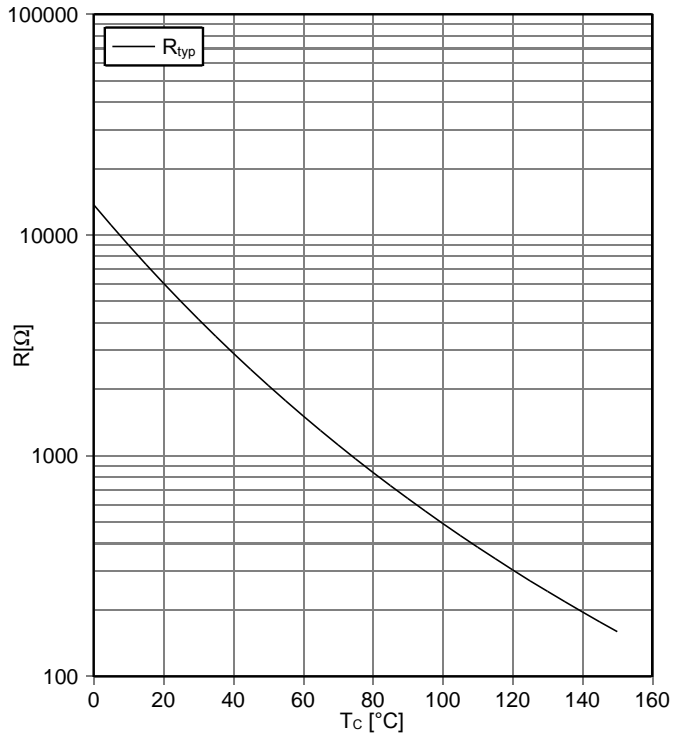

pressure drop in cooling circuit
 $\Delta p = f(\Delta V/\Delta t)$, cooler design according to AN-HPD-ASSEMBLY
 $T_f = 75^\circ\text{C}$; 50% water / 50% ethylenglycol

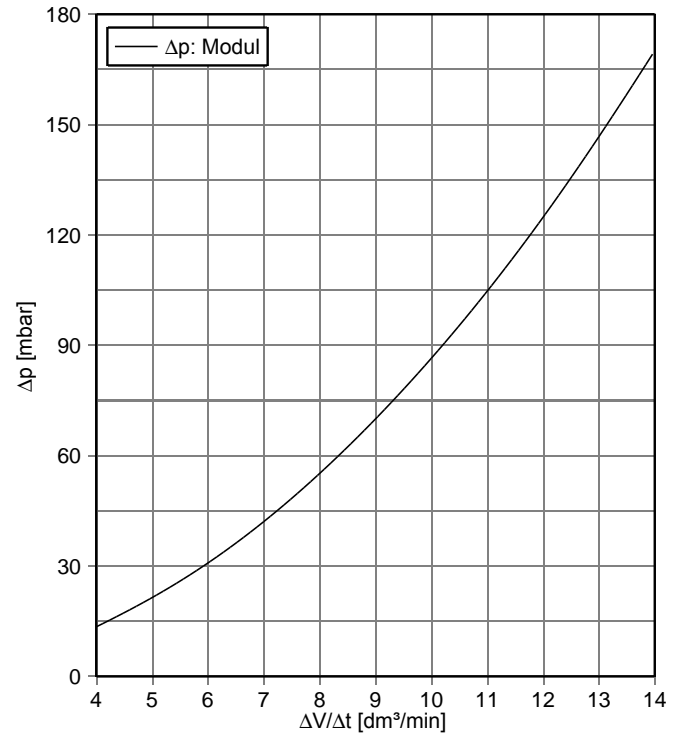

7 Circuit diagram

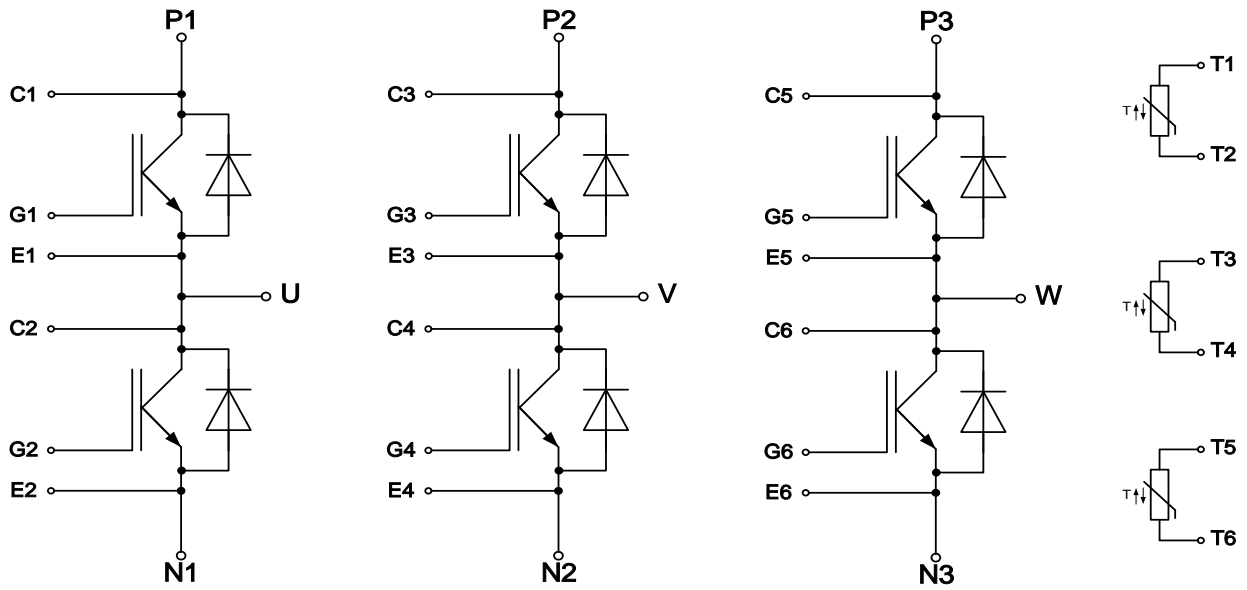

9 Label Codes

9.1 Module Code

Code Format	Data Matrix		
Encoding	ASCII Text		
Symbol Size	16x16		
Standard	IEC24720 and IEC16022		
Code Content	Content Module Serial Number Module Material Number Production Order Number Datecode (Production Year) Datecode (Production Week)	Digit 1 - 5 6 - 11 12 - 19 20 - 21 22 - 23	Example (below) 71549 142846 55054991 15 30
Example	 71549142846550549911530		

9.2 Packing Code

Code Format	Code128			
Encoding	Code Set A			
Symbol Size	34 digits			
Standard	IEC8859-1			
Code Content	Content Backend Construction Number Production Lot Number Serial Number Date Code Box Quantity	Identifier X 1T S 9D Q	Digit 2 - 9 12 - 19 21 - 25 28 - 31 33 - 34	Example (below) 95056609 2X0003E0 754389 1139 15
Example	 X950566091T2X0003E0S754389D1139Q15			

Revision History

Major changes since previous revision

Revision History

Reference	Date	Description
V2.0	2018-08-21	-
V3.0	2019-05-28	-

Terms & Conditions of usage

Edition 2018-08-01

Published by
Infineon Technologies AG
81726 Munich, Germany
© 2018 Infineon Technologies AG
All Rights Reserved.

Legal Disclaimer

The information given in this document shall in no event be regarded as a guarantee of conditions or characteristics. With respect to any examples or hints given herein, any typical values stated herein and/or any information regarding the application of the device, Infineon Technologies hereby disclaims any and all warranties and liabilities of any kind, including without limitation, warranties of non-infringement of intellectual property rights of any third party.

Information

For further information on technology, delivery terms and conditions and prices, please contact the nearest Infineon Technologies Office (<http://www.infineon.com>)

Warnings

Due to technical requirements, components may contain dangerous substances. For information on the types in question, please contact the nearest Infineon Technologies Office.

These components are not designed for "special applications" that demand extremely high reliability or safety such as aerospace, defense or life support devices or systems (Class III medical devices). If you intend to use the components in any of these special applications, please contact your local representative at International Rectifier HiRel Products, Inc. or the Infineon support (<https://www.infineon.com/support>) to review product requirements and reliability testing.

Infineon Technologies components may be used in special applications only with the express written approval of Infineon Technologies. Class III medical devices are intended to be implanted in the human body or to support and/or maintain and sustain and/or protect human life. If they fail, it is reasonable to assume that the health of the user or other persons may be endangered.

Trademarks

Trademarks of Infineon Technologies AG

AURIX™, C166™, CanPAK™, CIPOS™, CIPURSE™, EconoPACK™, CoolMOS™, CoolSET™, CORECONTROL™, CROSSAVE™, DAVE™, DI-POL™, EasyPIM™, EconoBRIDGE™, EconoDUAL™, EconoPIM™, EconoPACK™, EiceDRIVER™, eupec™, FCOS™, HITFET™, HybridPACK™, I²RFT™, ISOFACE™, IsoPACK™, MIPAQ™, ModSTACK™, my-d™, NovalithIC™, OptiMOS™, ORIGA™, POWERCODE™, PRIMARION™, PrimePACK™, PrimeSTACK™, PRO-SIL™, PROFET™, RASIC™, ReverSave™, SatRIC™, SIEGET™, SINDRION™, SIPMOS™, SmartLEWIS™, SOLID FLASH™, TEMPFET™, thinQ!™, TRENCHSTOP™, TriCore™.

Other Trademarks

Advance Design System™ (ADS) of Agilent Technologies, AMBA™, ARM™, MULTI-ICE™, KEIL™, PRIMECELL™, REALVIEW™, THUMB™, μVision™ of ARM Limited, UK. AUTOSAR™ is licensed by AUTOSAR development partnership. Bluetooth™ of Bluetooth SIG Inc. CAT-iq™ of DECT Forum. COLOSSUS™, FirstGPS™ of Trimble Navigation Ltd. EMV™ of EMVCo, LLC (Visa Holdings Inc.). EPCOS™ of Epcos AG. FLEXGO™ of Microsoft Corporation. FlexRay™ is licensed by FlexRay Consortium. HYPERTERMINAL™ of Hilgraeve Incorporated. IEC™ of Commission Electrotechnique Internationale. IrDA™ of Infrared Data Association Corporation. ISO™ of INTERNATIONAL ORGANIZATION FOR STANDARDIZATION. MATLAB™ of MathWorks, Inc. MAXIM™ of Maxim Integrated Products, Inc. MICROTEC™, NUCLEUS™ of Mentor Graphics Corporation. MIPI™ of MIPI Alliance, Inc. MIPS™ of MIPS Technologies, Inc., USA. muRata™ of MURATA MANUFACTURING CO., MICROWAVE OFFICE™ (MWO) of Applied Wave Research Inc., OmniVision™ of OmniVision Technologies, Inc. Openwave™ Openwave Systems Inc. RED HAT™ Red Hat, Inc. RFMD™ RF Micro Devices, Inc. SIRIUS™ of Sirius Satellite Radio Inc. SOLARIS™ of Sun Microsystems, Inc. SPANSION™ of Spansion LLC Ltd. Symbian™ of Symbian Software Limited. TAIYO YUDEN™ of Taiyo Yuden Co. TEAKLITE™ of CEVA, Inc. TEKTRONIX™ of Tektronix Inc. TOKO™ of TOKO KABUSHIKI KAISHA TA. UNIX™ of X/Open Company Limited. VERILOG™, PALLADIUM™ of Cadence Design Systems, Inc. VLYNQ™ of Texas Instruments Incorporated. VXWORKS™, WIND RIVER™ of WIND RIVER SYSTEMS, INC. ZETEX™ of Diodes Zetex Limited.

Last update

2011-11-11

www.infineon.com