



EconoPACK™3 Modul PressFIT mit Trench/Feldstopp IGBT4 und Emitter Controlled4 Diode  
EconoPACK™3 module PressFIT with trench/fieldstop IGBT4 and Emitter Controlled4 diode

暫定データ  
Preliminary Data

IGBT- インバータ / IGBT, Inverter  
最大定格 / Maximum Rated Values

コレクタ・エミッタ間電圧 Collector-emitter voltage	$T_{vj} = 25^{\circ}\text{C}$	$V_{CES}$	1200	V
連続DCコレクタ電流 Continuous DC collector current	$T_C = 95^{\circ}\text{C}, T_{vj\text{ max}} = 175^{\circ}\text{C}$	$I_{C\text{ nom}}$	100	A
繰り返しピークコレクタ電流 Repetitive peak collector current	$t_P = 1\text{ ms}$	$I_{CRM}$	200	A
トータル損失 Total power dissipation	$T_C = 25^{\circ}\text{C}, T_{vj\text{ max}} = 175$	$P_{tot}$	515	W
ゲート・エミッタ間ピーク電圧 Gate-emitter peak voltage		$V_{GES}$	+/-20	V

電気的特性 / Characteristic Values

			min.	typ.	max.		
コレクタ・エミッタ間飽和電圧 Collector-emitter saturation voltage	$I_C = 100\text{ A}, V_{GE} = 15\text{ V}$ $I_C = 100\text{ A}, V_{GE} = 15\text{ V}$ $I_C = 100\text{ A}, V_{GE} = 15\text{ V}$	$T_{vj} = 25^{\circ}\text{C}$ $T_{vj} = 125^{\circ}\text{C}$ $T_{vj} = 150^{\circ}\text{C}$	$V_{CE\text{ sat}}$	1,75 2,05 2,10	2,20	V V V	
ゲート・エミッタ間しきい値電圧 Gate threshold voltage	$I_C = 4,00\text{ mA}, V_{CE} = V_{GE}, T_{vj} = 25^{\circ}\text{C}$		$V_{GEth}$	5,2	5,8	6,4	V
ゲート電荷量 Gate charge	$V_{GE} = -15\text{ V} \dots +15\text{ V}$		$Q_G$	0,80			$\mu\text{C}$
内蔵ゲート抵抗 Internal gate resistor	$T_{vj} = 25^{\circ}\text{C}$		$R_{Gint}$	7,5			$\Omega$
入力容量 Input capacitance	$f = 1\text{ MHz}, T_{vj} = 25^{\circ}\text{C}, V_{CE} = 25\text{ V}, V_{GE} = 0\text{ V}$		$C_{ies}$	6,30			nF
帰還容量 Reverse transfer capacitance	$f = 1\text{ MHz}, T_{vj} = 25^{\circ}\text{C}, V_{CE} = 25\text{ V}, V_{GE} = 0\text{ V}$		$C_{res}$	0,27			nF
コレクタ・エミッタ間遮断電流 Collector-emitter cut-off current	$V_{CE} = 1200\text{ V}, V_{GE} = 0\text{ V}, T_{vj} = 25^{\circ}\text{C}$		$I_{CES}$			1,0	mA
ゲート・エミッタ間漏れ電流 Gate-emitter leakage current	$V_{CE} = 0\text{ V}, V_{GE} = 20\text{ V}, T_{vj} = 25^{\circ}\text{C}$		$I_{GES}$			100	nA
ターンオン遅れ時間 (誘導負荷) Turn-on delay time, inductive load	$I_C = 100\text{ A}, V_{CE} = 600\text{ V}$ $V_{GE} = \pm 15\text{ V}$ $R_{Gon} = 1,6\ \Omega$	$T_{vj} = 25^{\circ}\text{C}$ $T_{vj} = 125^{\circ}\text{C}$ $T_{vj} = 150^{\circ}\text{C}$	$t_{don}$	0,115 0,13 0,135			$\mu\text{s}$ $\mu\text{s}$ $\mu\text{s}$
ターンオン上昇時間 (誘導負荷) Rise time, inductive load	$I_C = 100\text{ A}, V_{CE} = 600\text{ V}$ $V_{GE} = \pm 15\text{ V}$ $R_{Gon} = 1,6\ \Omega$	$T_{vj} = 25^{\circ}\text{C}$ $T_{vj} = 125^{\circ}\text{C}$ $T_{vj} = 150^{\circ}\text{C}$	$t_r$	0,025 0,03 0,03			$\mu\text{s}$ $\mu\text{s}$ $\mu\text{s}$
ターンオフ遅れ時間 (誘導負荷) Turn-off delay time, inductive load	$I_C = 100\text{ A}, V_{CE} = 600\text{ V}$ $V_{GE} = \pm 15\text{ V}$ $R_{Goff} = 1,6\ \Omega$	$T_{vj} = 25^{\circ}\text{C}$ $T_{vj} = 125^{\circ}\text{C}$ $T_{vj} = 150^{\circ}\text{C}$	$t_{doff}$	0,37 0,45 0,48			$\mu\text{s}$ $\mu\text{s}$ $\mu\text{s}$
ターンオフ下降時間 (誘導負荷) Fall time, inductive load	$I_C = 100\text{ A}, V_{CE} = 600\text{ V}$ $V_{GE} = \pm 15\text{ V}$ $R_{Goff} = 1,6\ \Omega$	$T_{vj} = 25^{\circ}\text{C}$ $T_{vj} = 125^{\circ}\text{C}$ $T_{vj} = 150^{\circ}\text{C}$	$t_f$	0,06 0,08 0,09			$\mu\text{s}$ $\mu\text{s}$ $\mu\text{s}$
ターンオンスイッチング損失 Turn-on energy loss per pulse	$I_C = 100\text{ A}, V_{CE} = 600\text{ V}, L_S = 40\text{ nH}$ $V_{GE} = \pm 15\text{ V}, di/dt = 3700\text{ A}/\mu\text{s} (T_{vj} = 150^{\circ}\text{C})$ $R_{Gon} = 1,6\ \Omega$	$T_{vj} = 25^{\circ}\text{C}$ $T_{vj} = 125^{\circ}\text{C}$ $T_{vj} = 150^{\circ}\text{C}$	$E_{on}$	4,00 6,50 7,50			mJ mJ mJ
ターンオフスイッチング損失 Turn-off energy loss per pulse	$I_C = 100\text{ A}, V_{CE} = 600\text{ V}, L_S = 40\text{ nH}$ $V_{GE} = \pm 15\text{ V}, du/dt = 3600\text{ V}/\mu\text{s} (T_{vj} = 150^{\circ}\text{C})$ $R_{Goff} = 1,6\ \Omega$	$T_{vj} = 25^{\circ}\text{C}$ $T_{vj} = 125^{\circ}\text{C}$ $T_{vj} = 150^{\circ}\text{C}$	$E_{off}$	5,50 8,50 9,50			mJ mJ mJ
短絡電流 SC data	$V_{GE} \leq 15\text{ V}, V_{CC} = 900\text{ V}$ $V_{CE\text{ max}} = V_{CES} - L_{SCE} \cdot di/dt$ $t_P \leq 10\ \mu\text{s}, T_{vj} = 150^{\circ}\text{C}$		$I_{SC}$	360			A
ジャンクション・ケース間熱抵抗 Thermal resistance, junction to case	IGBT部 ( 1素子当り ) / per IGBT		$R_{thJC}$		0,29		K/W
ケース・ヒートシンク間熱抵抗 Thermal resistance, case to heatsink	IGBT部 ( 1素子当り ) / per IGBT $\lambda_{\text{Paste}} = 1\text{ W}/(\text{m}\cdot\text{K})$ / $\lambda_{\text{grease}} = 1\text{ W}/(\text{m}\cdot\text{K})$		$R_{thCH}$	0,085			K/W
動作温度 Temperature under switching conditions			$T_{vj\text{ op}}$	-40	150		$^{\circ}\text{C}$

prepared by: CM	date of publication: 2013-10-29
approved by: RS	revision: 2.0



暫定データ  
Preliminary Data

Diode、インバータ / Diode, Inverter  
最大定格 / Maximum Rated Values

ピーク繰返し逆電圧 Repetitive peak reverse voltage	$T_{vj} = 25^{\circ}\text{C}$	$V_{RRM}$	1200	V
連続DC電流 Continuous DC forward current		$I_F$	100	A
ピーク繰返し順電流 Repetitive peak forward current	$t_P = 1\text{ ms}$	$I_{FRM}$	200	A
電流二乗時間積 $I^2t$ - value	$V_R = 0\text{ V}, t_P = 10\text{ ms}, T_{vj} = 125^{\circ}\text{C}$ $V_R = 0\text{ V}, t_P = 10\text{ ms}, T_{vj} = 150^{\circ}\text{C}$	$I^2t$	1550 1500	$\text{A}^2\text{s}$ $\text{A}^2\text{s}$

電気的特性 / Characteristic Values

			min.	typ.	max.	
順電圧 Forward voltage	$I_F = 100\text{ A}, V_{GE} = 0\text{ V}$ $I_F = 100\text{ A}, V_{GE} = 0\text{ V}$ $I_F = 100\text{ A}, V_{GE} = 0\text{ V}$	$T_{vj} = 25^{\circ}\text{C}$ $T_{vj} = 125^{\circ}\text{C}$ $T_{vj} = 150^{\circ}\text{C}$	$V_F$	1,70 1,65 1,65	2,15	V V V
ピーク逆回復電流 Peak reverse recovery current	$I_F = 100\text{ A}, -di_F/dt = 3600\text{ A}/\mu\text{s} (T_{vj}=150^{\circ}\text{C})$ $V_R = 600\text{ V}$ $V_{GE} = -15\text{ V}$	$T_{vj} = 25^{\circ}\text{C}$ $T_{vj} = 125^{\circ}\text{C}$ $T_{vj} = 150^{\circ}\text{C}$	$I_{RM}$	150 160 165		A A A
逆回復電荷量 Recovered charge	$I_F = 100\text{ A}, -di_F/dt = 3600\text{ A}/\mu\text{s} (T_{vj}=150^{\circ}\text{C})$ $V_R = 600\text{ V}$ $V_{GE} = -15\text{ V}$	$T_{vj} = 25^{\circ}\text{C}$ $T_{vj} = 125^{\circ}\text{C}$ $T_{vj} = 150^{\circ}\text{C}$	$Q_r$	9,60 17,0 19,0		$\mu\text{C}$ $\mu\text{C}$ $\mu\text{C}$
逆回復損失 Reverse recovery energy	$I_F = 100\text{ A}, -di_F/dt = 3600\text{ A}/\mu\text{s} (T_{vj}=150^{\circ}\text{C})$ $V_R = 600\text{ V}$ $V_{GE} = -15\text{ V}$	$T_{vj} = 25^{\circ}\text{C}$ $T_{vj} = 125^{\circ}\text{C}$ $T_{vj} = 150^{\circ}\text{C}$	$E_{rec}$	4,10 7,00 8,00		mJ mJ mJ
ジャンクション・ケース間熱抵抗 Thermal resistance, junction to case	/Diode ( 1 素子当り ) / per diode		$R_{thJC}$		0,50	K/W
ケース・ヒートシンク間熱抵抗 Thermal resistance, case to heatsink	/Diode ( 1 素子当り ) / per diode $\lambda_{Paste} = 1\text{ W}/(\text{m}\cdot\text{K}) / \lambda_{grease} = 1\text{ W}/(\text{m}\cdot\text{K})$		$R_{thCH}$	0,145		K/W
動作温度 Temperature under switching conditions			$T_{vj op}$	-40	150	$^{\circ}\text{C}$

NTC-サーミスタ / NTC-Thermistor

電気的特性 / Characteristic Values

			min.	typ.	max.	
定格抵抗値 Rated resistance	$T_C = 25^{\circ}\text{C}$		$R_{25}$	5,00		$\text{k}\Omega$
R100の偏差 Deviation of R100	$T_C = 100^{\circ}\text{C}, R_{100} = 493\ \Omega$		$\Delta R/R$	-5	5	%
損失 Power dissipation	$T_C = 25^{\circ}\text{C}$		$P_{25}$		20,0	mW
B-定数 B-value	$R_2 = R_{25} \exp [B_{25/50}(1/T_2 - 1/(298,15\text{ K}))]$		$B_{25/50}$	3375		K
B-定数 B-value	$R_2 = R_{25} \exp [B_{25/80}(1/T_2 - 1/(298,15\text{ K}))]$		$B_{25/80}$	3411		K
B-定数 B-value	$R_2 = R_{25} \exp [B_{25/100}(1/T_2 - 1/(298,15\text{ K}))]$		$B_{25/100}$	3433		K

適切なアプリケーションノートによる仕様  
Specification according to the valid application note.

prepared by: CM	date of publication: 2013-10-29
approved by: RS	revision: 2.0



暫定データ  
Preliminary Data

モジュール / Module

絶縁耐圧 Isolation test voltage	RMS, f = 50 Hz, t = 1 min	V <sub>ISOL</sub>	2,5		kV
ベースプレート材質 Material of module baseplate			Cu		
内部絶縁 Internal isolation	基礎絶縁 (クラス1, IEC 61140) basic insulation (class 1, IEC 61140)		Al <sub>2</sub> O <sub>3</sub>		
沿面距離 Creepage distance	連絡方法 - ヒートシンク / terminal to heatsink 連絡方法 - 連絡方法 / terminal to terminal		10,0		mm
空間距離 Clearance	連絡方法 - ヒートシンク / terminal to heatsink 連絡方法 - 連絡方法 / terminal to terminal		7,5		mm
相対トラッキング指数 Comperative tracking index		CTI	> 200		
			min.	typ.	max.
ケース・ヒートシンク間熱抵抗 Thermal resistance, case to heatsink	/モジュール / per module $\lambda_{\text{Paste}} = 1 \text{ W/(m}\cdot\text{K)} / \lambda_{\text{grease}} = 1 \text{ W/(m}\cdot\text{K)}$	R <sub>thCH</sub>	0,009		K/W
内部インダクタンス Stray inductance module		L <sub>sCE</sub>	21		nH
パワーターミナル・チップ間抵抗 Module lead resistance, terminals - chip	T <sub>C</sub> = 25°C, /スイッチ / per switch	R <sub>CC+EE'</sub>	1,80		mΩ
保存温度 Storage temperature		T <sub>stg</sub>	-40	125	°C
取り付けネジ締め付けトルク Mounting torque for modul mounting	取り付けネジ M5 適切なアプリケーションノートによるマウンティング Screw M5 - Mounting according to valid application note	M	3,00	-	6,00 Nm
質量 Weight		G	300		g

prepared by: CM	date of publication: 2013-10-29
approved by: RS	revision: 2.0



暫定データ  
Preliminary Data

出力特性 IGBT- インバータ (Typical)  
output characteristic IGBT, Inverter (typical)

$I_c = f(V_{CE})$   
 $V_{GE} = 15\text{ V}$

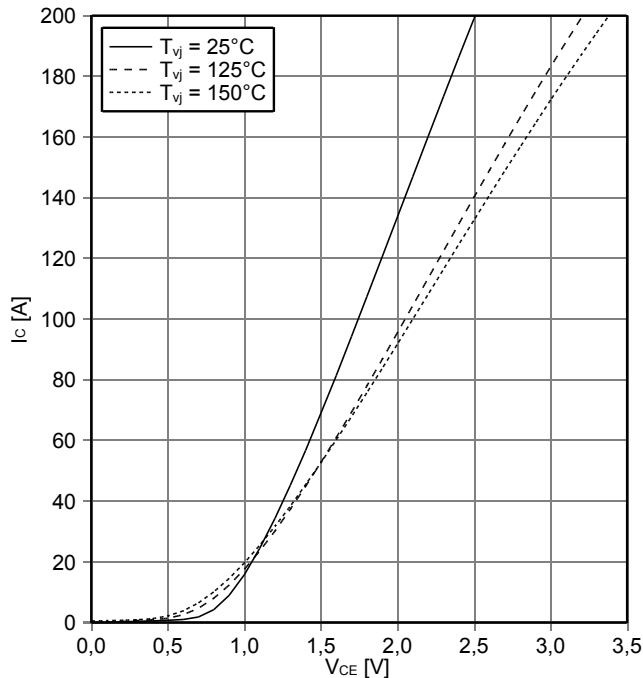

出力特性 IGBT- インバータ (Typical)  
output characteristic IGBT, Inverter (typical)

$I_c = f(V_{CE})$   
 $T_{vj} = 150^\circ\text{C}$

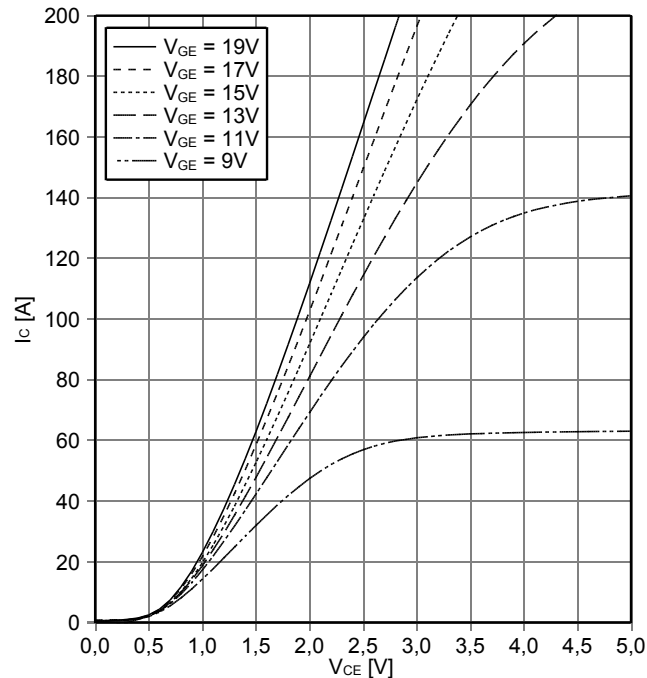

伝達特性 IGBT- インバータ (Typical)  
transfer characteristic IGBT, Inverter (typical)

$I_c = f(V_{GE})$   
 $V_{CE} = 20\text{ V}$

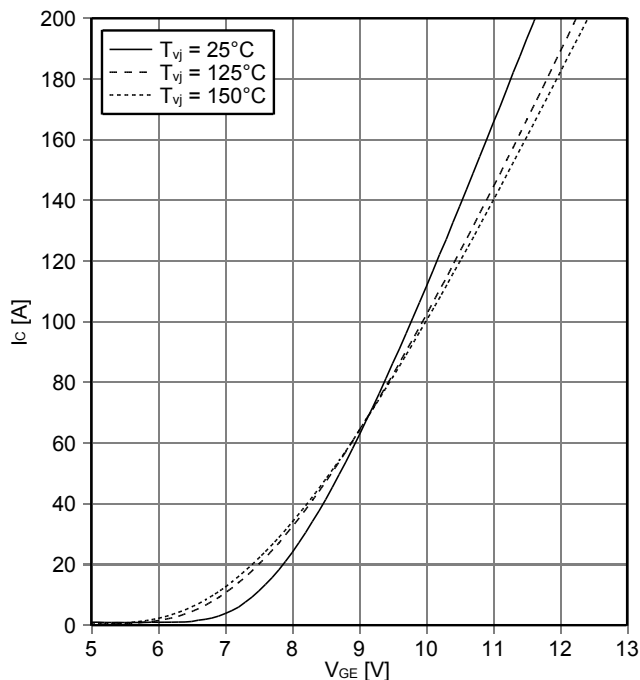

スイッチング損失 IGBT- インバータ (Typical)  
switching losses IGBT, Inverter (typical)

$E_{on} = f(I_c)$ ,  $E_{off} = f(I_c)$   
 $V_{GE} = \pm 15\text{ V}$ ,  $R_{Gon} = 1.6\ \Omega$ ,  $R_{Goff} = 1.6\ \Omega$ ,  $V_{CE} = 600\text{ V}$

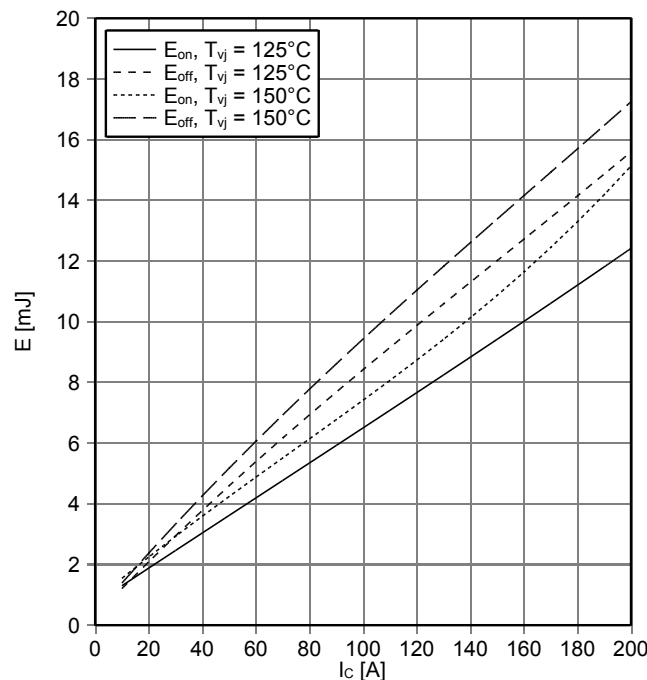

prepared by: CM	date of publication: 2013-10-29
approved by: RS	revision: 2.0



暫定データ  
Preliminary Data

スイッチング損失 IGBT- インバータ (Typical)  
switching losses IGBT, Inverter (typical)

$E_{on} = f(R_G), E_{off} = f(R_G)$   
 $V_{GE} = \pm 15\text{ V}, I_C = 100\text{ A}, V_{CE} = 600\text{ V}$

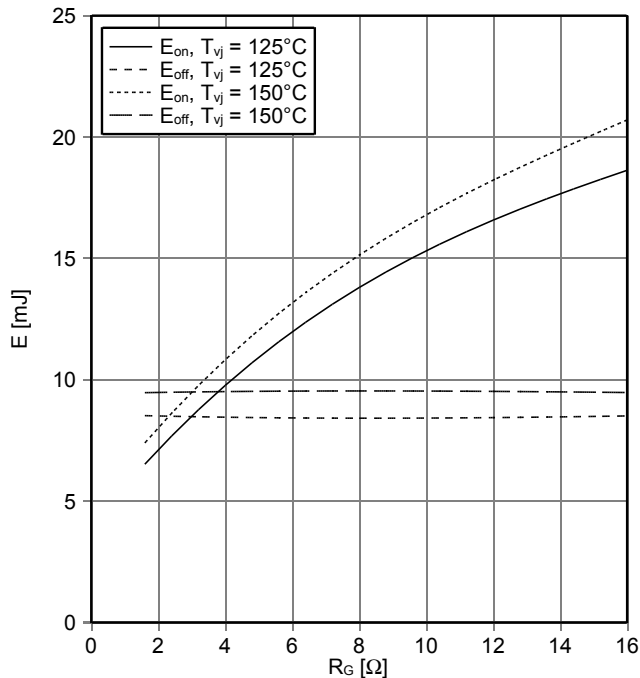

過渡熱インピーダンス IGBT- インバータ  
transient thermal impedance IGBT, Inverter

$Z_{thJC} = f(t)$

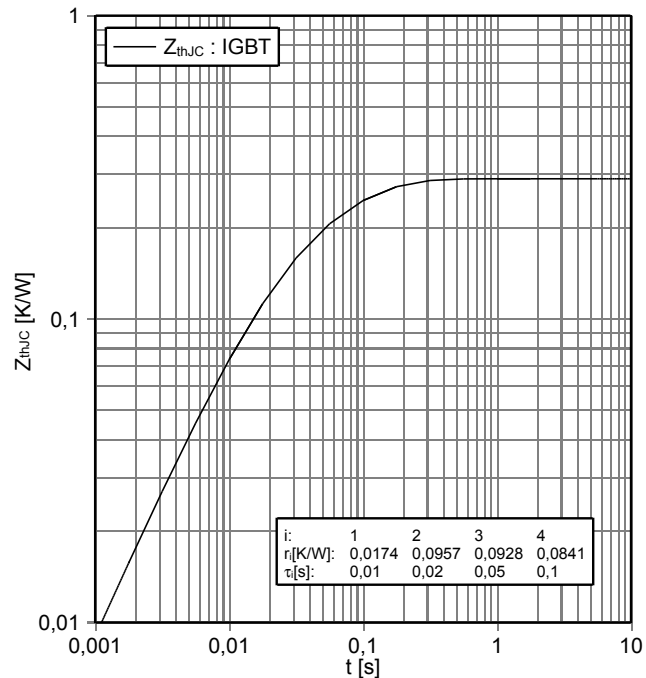

逆バイアス安全動作領域 IGBT- インバータ (RBSOA)  
reverse bias safe operating area IGBT, Inverter (RBSOA)

$I_C = f(V_{CE})$   
 $V_{GE} = \pm 15\text{ V}, R_{Goff} = 1.6\ \Omega, T_{vj} = 150^\circ\text{C}$

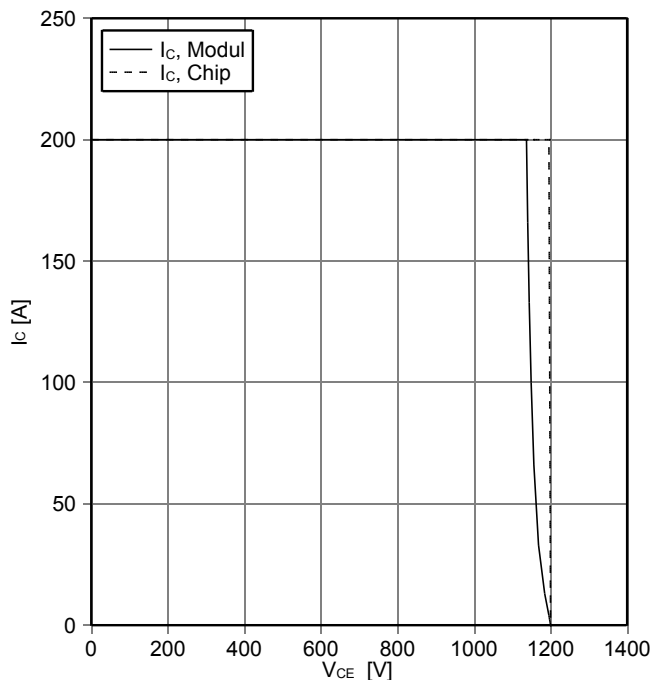

順電圧特性 Diode、インバータ (typical)  
forward characteristic of Diode, Inverter (typical)

$I_F = f(V_F)$

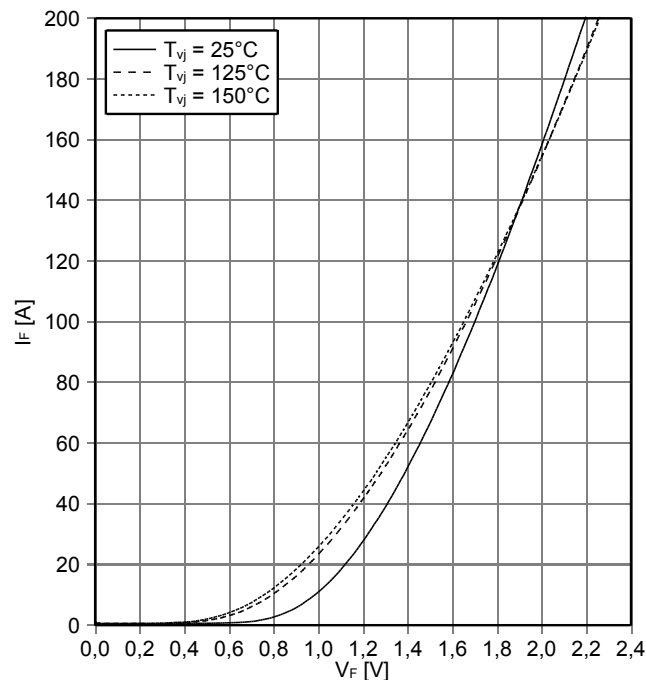

prepared by: CM	date of publication: 2013-10-29
approved by: RS	revision: 2.0



暫定データ  
Preliminary Data

スイッチング損失 Diode、インバータ (Typical)  
switching losses Diode, Inverter (typical)

$E_{rec} = f(I_F)$   
 $R_{Gon} = 1.6 \Omega, V_{CE} = 600 V$

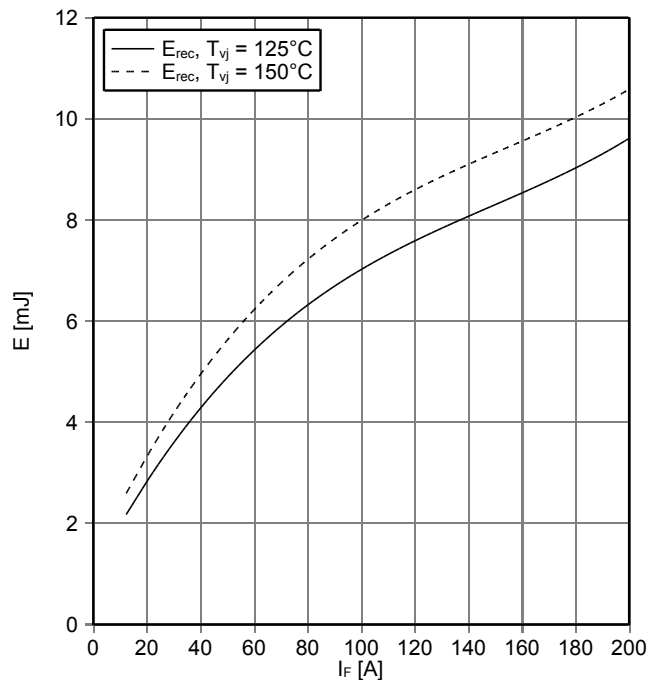

スイッチング損失 Diode、インバータ (Typical)  
switching losses Diode, Inverter (typical)

$E_{rec} = f(R_G)$   
 $I_F = 100 A, V_{CE} = 600 V$

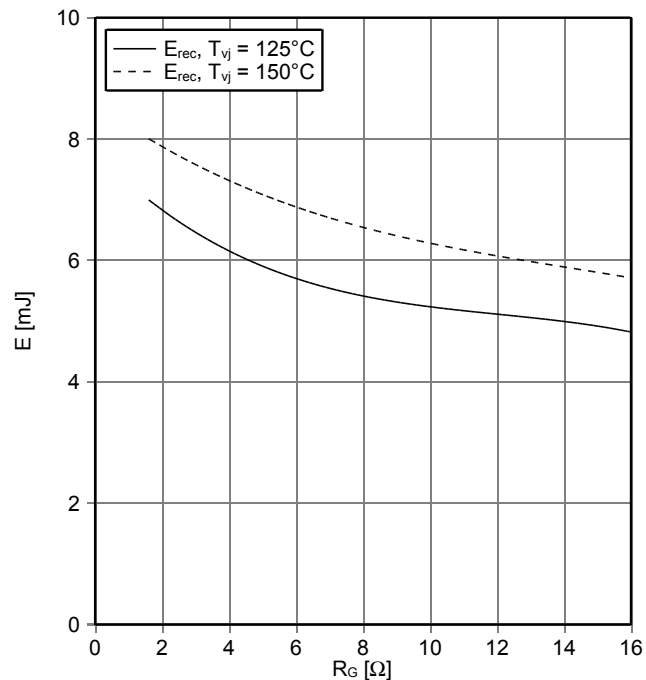

過渡熱インピーダンス Diode、インバータ  
transient thermal impedance Diode, Inverter

$Z_{thJC} = f(t)$

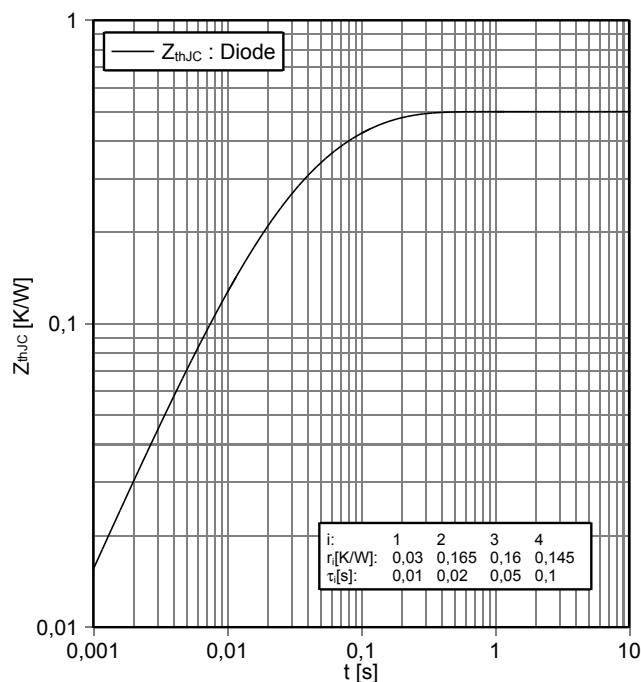

NTC-サーミスタ サーミスタの温度特性  
NTC-Thermistor-temperature characteristic (typical)

$R = f(T)$



prepared by: CM	date of publication: 2013-10-29
approved by: RS	revision: 2.0

暫定データ  
Preliminary Data

回路図 / circuit\_diagram\_headline

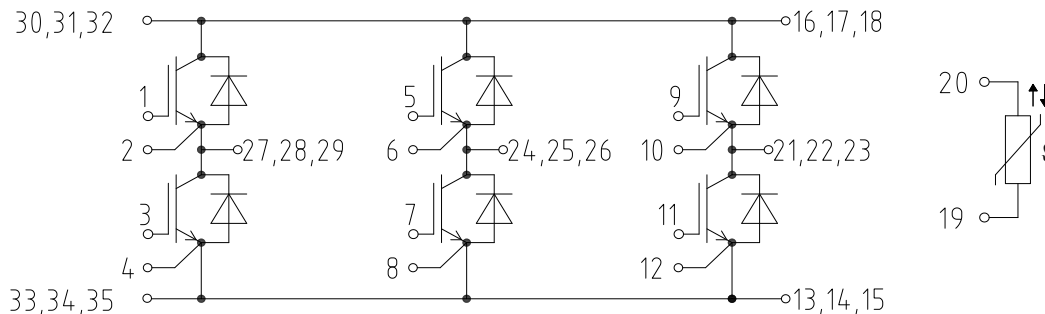

パッケージ概要 / package outlines

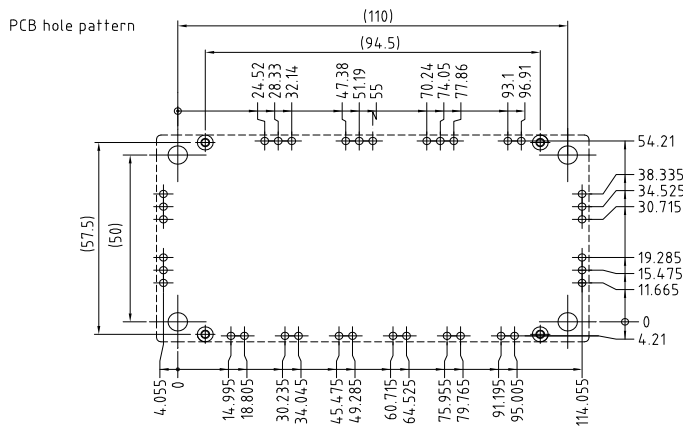
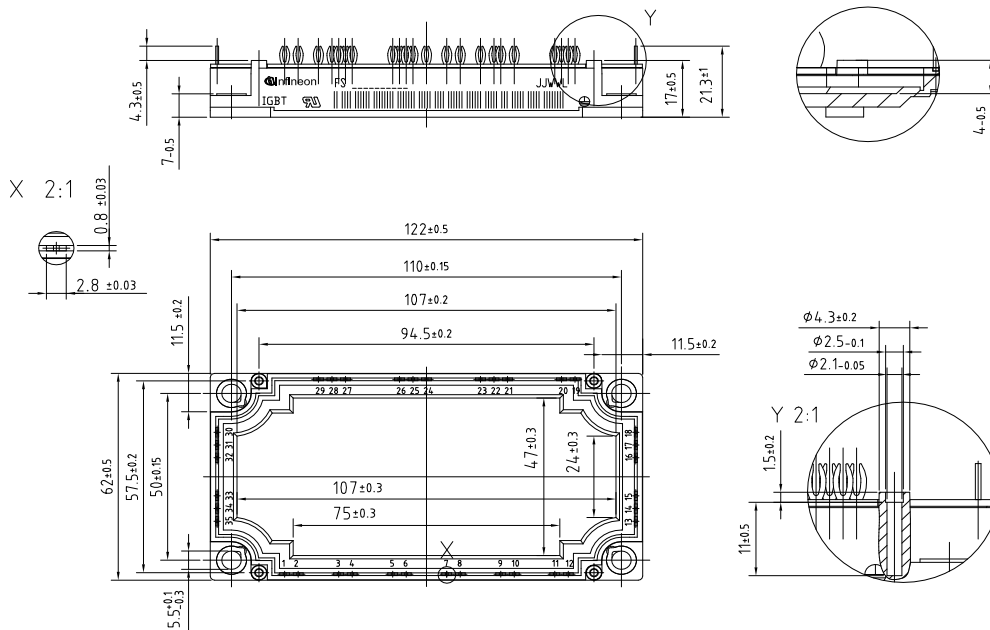

- Tolerance of PCB hole pattern  $\pm \phi 0.1$
- hole specifications see AN 2007-09
- Diameters of plated holes  $\phi 2.14\text{mm} - 2.29\text{mm}$
- Diameter of drill  $\phi 2.35\text{mm}$

prepared by: CM	date of publication: 2013-10-29
approved by: RS	revision: 2.0



**暫定データ  
Preliminary Data**

この日本語は、あくまで参考訳となりますので、正式はデータシートに記載されている英文の物となります。

この日本語は、あくまで参考訳となりますので、正式はデータシートに記載されている英文の物となります。

**利用規約**

このデータシートに記載されているデータ類は、技術者向けの物です。このデバイスを使用される際は、製品が使用されるアプリケーションにて、ご評価頂いた上で、アプリケーションに適切にご判断願います。

このデータシートには、保証されている特性が記述されております。

その他、保証内容は個々の契約期間や条件に応じて決定されます。

保証は、アプリケーションやその特性に対しては行いません。

実際のアプリケーションでの利用に関しては、必ず相当モジュールのアセンブリノートをご確認ください。

追加の技術的情報、アプリケーションでの使用方法について、ご質問がある際には、最寄のセールスオフィスにお問い合わせ願います。(www.infineon.com 参照)

製品にご興味頂き必要があれば、アプリケーションノートを準備させて頂くケースもあります。

技術的な要求によっては、当該製品が危険な物になり得る可能性があります。このようなことが起こる可能性がある場合は、製品を使用される方の責任にて、弊社セールスオフィスに連絡願います。

航空関連、もしくは医療機器や生命維持装置に使用される場合は、インフィニオンと下記の項目を合意しているか、ご確認願います。

— リスク 及び 品質の評価

— 品質契約

— アプリケーションの共同評価

上記の内容の状況に応じて、製品を出荷の判断をさせて頂く場合がございます。

必要に応じて、この規約を関係される方々に送付してください。

インフィニオンはこのデータシートを変更する権利を有します。

**Terms & Conditions of usage**

The data contained in this product data sheet is exclusively intended for technically trained staff. You and your technical departments will have to evaluate the suitability of the product for the intended application and the completeness of the product data with respect to such application.

This product data sheet is describing the characteristics of this product for which a warranty is granted. Any such warranty is granted exclusively pursuant the terms and conditions of the supply agreement. There will be no guarantee of any kind for the product and its characteristics. The information in the valid application- and assembly notes of the module must be considered.

Should you require product information in excess of the data given in this product data sheet or which concerns the specific application of our product, please contact the sales office, which is responsible for you ( see www.infineon.com ). For those that are specifically interested we may provide application notes.

Due to technical requirements our product may contain dangerous substances. For information on the types in question please contact the sales office, which is responsible for you.

Should you intend to use the Product in aviation applications, in health or live endangering or life support applications, please notify. Please note, that for any such applications we urgently recommend

- to perform joint Risk and Quality Assessments;

- the conclusion of Quality Agreements;

- to establish joint measures of an ongoing product survey, and that we may make delivery depended on the realization of any such measures.

If and to the extent necessary, please forward equivalent notices to your customers.

Changes of this product data sheet are reserved.

prepared by: CM	date of publication: 2013-10-29
approved by: RS	revision: 2.0