

EconoPIM™3 モジュール トレンチ/フィールドストップ IGBT4とエミッターコントロール4ダイオード内蔵
とPressFIT / NTCサーミスタ / TIM

EconoPIM™3 module with Trench/Fieldstop IGBT4 and Emitter Controlled 4 diode and PressFIT / NTC / TIM

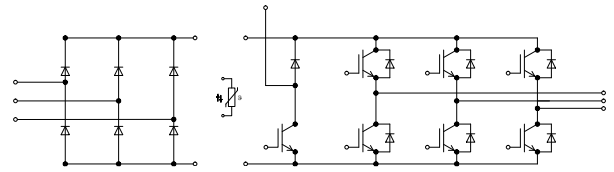

Typical appearance



$V_{CES} = 1200V$

$I_{C\ nom} = 150A / I_{CRM} = 300A$

アプリケーションの可能性

- サーボ駆動
- モーター駆動
- 補助インバーター

電気的特性

- $T_{vj\ op} = 150^{\circ}C$
- 低 V_{CESat} 飽和電圧
- 正温度特性を持った V_{CESat} 飽和電圧

機械的特性

- PressFIT 接合 技術
- 予め塗布されたサーマルインターフェース材料
- 内蔵されたNTCサーミスタ
- 標準ハウジング
- 銅ベースプレート
- 高いパワー密度

Potential Applications

- Servo drives
- Motor drives
- Auxiliary inverters

Electrical Features

- $T_{vj\ op} = 150^{\circ}C$
- LOW V_{CESat}
- V_{CESat} with positive temperature coefficient

Mechanical Features

- PressFIT contact technology
- Pre-applied Thermal Interface Material
- Integrated NTC temperature sensor
- Standard housing
- Copper base plate
- High power density

Module Label Code

Barcode Code 128



DMX - Code



Content of the Code

Content of the Code	Digit
Module Serial Number	1 - 5
Module Material Number	6 - 11
Production Order Number	12 - 19
Datecode (Production Year)	20 - 21
Datecode (Production Week)	22 - 23

IGBT- インバータ / IGBT, Inverter

最大定格 / Maximum Rated Values

コレクタ・エミッタ間電圧 Collector-emitter voltage	$T_{vj} = 25^{\circ}\text{C}$	V_{CES}	1200	V
連続DCコレクタ電流 Continuous DC collector current	$T_H = 75^{\circ}\text{C}, T_{vj\max} = 175^{\circ}\text{C}$	$I_{C\text{nom}}$	150	A
繰り返しピークコレクタ電流 Repetitive peak collector current	$t_p = 1\text{ ms}$	I_{CRM}	300	A
ゲート・エミッタ間ピーク電圧 Gate-emitter peak voltage		V_{GES}	+/-20	V

電気的特性 / Characteristic Values

		min.	typ.	max.	
コレクタ・エミッタ間飽和電圧 Collector-emitter saturation voltage	$I_C = 150\text{ A}, V_{GE} = 15\text{ V}$ $I_C = 150\text{ A}, V_{GE} = 15\text{ V}$ $I_C = 150\text{ A}, V_{GE} = 15\text{ V}$	$T_{vj} = 25^{\circ}\text{C}$ $T_{vj} = 125^{\circ}\text{C}$ $T_{vj} = 150^{\circ}\text{C}$	$V_{CE\text{sat}}$	1,75 2,05 2,10	2,10 V V V
ゲート・エミッタ間しきい値電圧 Gate threshold voltage	$I_C = 5,70\text{ mA}, V_{CE} = V_{GE}, T_{vj} = 25^{\circ}\text{C}$		V_{GEth}	5,25 5,80 6,35	V
ゲート電荷量 Gate charge	$V_{GE} = -15\text{ V} \dots +15\text{ V}$		Q_G	1,20	μC
内蔵ゲート抵抗 Internal gate resistor	$T_{vj} = 25^{\circ}\text{C}$		R_{Gint}	5,0	Ω
入力容量 Input capacitance	$f = 1\text{ MHz}, T_{vj} = 25^{\circ}\text{C}, V_{CE} = 25\text{ V}, V_{GE} = 0\text{ V}$		C_{ies}	9,35	nF
帰還容量 Reverse transfer capacitance	$f = 1\text{ MHz}, T_{vj} = 25^{\circ}\text{C}, V_{CE} = 25\text{ V}, V_{GE} = 0\text{ V}$		C_{res}	0,41	nF
コレクタ・エミッタ間遮断電流 Collector-emitter cut-off current	$V_{CE} = 1200\text{ V}, V_{GE} = 0\text{ V}, T_{vj} = 25^{\circ}\text{C}$		I_{CES}		1,0 mA
ゲート・エミッタ間漏れ電流 Gate-emitter leakage current	$V_{CE} = 0\text{ V}, V_{GE} = 20\text{ V}, T_{vj} = 25^{\circ}\text{C}$		I_{GES}		100 nA
ターンオン遅れ時間 (誘導負荷) Turn-on delay time, inductive load	$I_C = 150\text{ A}, V_{CE} = 600\text{ V}$ $V_{GE} = \pm 15\text{ V}$ $R_{Gon} = 6,8\ \Omega$	$T_{vj} = 25^{\circ}\text{C}$ $T_{vj} = 125^{\circ}\text{C}$ $T_{vj} = 150^{\circ}\text{C}$	t_{don}	0,16 0,19 0,19	μs μs μs
ターンオン上昇時間 (誘導負荷) Rise time, inductive load	$I_C = 150\text{ A}, V_{CE} = 600\text{ V}$ $V_{GE} = \pm 15\text{ V}$ $R_{Gon} = 6,8\ \Omega$	$T_{vj} = 25^{\circ}\text{C}$ $T_{vj} = 125^{\circ}\text{C}$ $T_{vj} = 150^{\circ}\text{C}$	t_r	0,07 0,08 0,08	μs μs μs
ターンオフ遅れ時間 (誘導負荷) Turn-off delay time, inductive load	$I_C = 150\text{ A}, V_{CE} = 600\text{ V}$ $V_{GE} = \pm 15\text{ V}$ $R_{Goff} = 6,8\ \Omega$	$T_{vj} = 25^{\circ}\text{C}$ $T_{vj} = 125^{\circ}\text{C}$ $T_{vj} = 150^{\circ}\text{C}$	t_{doff}	0,42 0,48 0,53	μs μs μs
ターンオフ下降時間 (誘導負荷) Fall time, inductive load	$I_C = 150\text{ A}, V_{CE} = 600\text{ V}$ $V_{GE} = \pm 15\text{ V}$ $R_{Goff} = 6,8\ \Omega$	$T_{vj} = 25^{\circ}\text{C}$ $T_{vj} = 125^{\circ}\text{C}$ $T_{vj} = 150^{\circ}\text{C}$	t_f	0,10 0,19 0,22	μs μs μs
ターンオンスイッチング損失 Turn-on energy loss per pulse	$I_C = 150\text{ A}, V_{CE} = 600\text{ V}, L_S = 35\text{ nH}$ $V_{GE} = \pm 15\text{ V}, di/dt = 1600\text{ A}/\mu\text{s} (T_{vj} = 150^{\circ}\text{C})$ $R_{Gon} = 6,8\ \Omega$	$T_{vj} = 25^{\circ}\text{C}$ $T_{vj} = 125^{\circ}\text{C}$ $T_{vj} = 150^{\circ}\text{C}$	E_{on}	22,0 28,5 30,5	mJ mJ mJ
ターンオフスイッチング損失 Turn-off energy loss per pulse	$I_C = 150\text{ A}, V_{CE} = 600\text{ V}, L_S = 35\text{ nH}$ $V_{GE} = \pm 15\text{ V}, du/dt = 3600\text{ V}/\mu\text{s} (T_{vj} = 150^{\circ}\text{C})$ $R_{Goff} = 6,8\ \Omega$	$T_{vj} = 25^{\circ}\text{C}$ $T_{vj} = 125^{\circ}\text{C}$ $T_{vj} = 150^{\circ}\text{C}$	E_{off}	9,80 15,0 17,0	mJ mJ mJ
短絡電流 SC data	$V_{GE} \leq 15\text{ V}, V_{CC} = 800\text{ V}$ $V_{CE\text{max}} = V_{CES} - L_{SCE} \cdot di/dt$ $t_p \leq 10\ \mu\text{s}, T_{vj} = 150^{\circ}\text{C}$		I_{SC}	540	A
ジャンクション・ヒートシンク間熱抵抗 Thermal resistance, junction to heatsink	IGBT部 (1素子当り) / per IGBT valid with IFX pre-applied thermal interface material		R_{thJH}		0,250 K/W
動作温度 Temperature under switching conditions			$T_{vj\text{op}}$	-40	150 $^{\circ}\text{C}$

Diode、インバータ / Diode, Inverter 最大定格 / Maximum Rated Values

ピーク繰返し逆電圧 Repetitive peak reverse voltage	$T_{vj} = 25^{\circ}\text{C}$	V_{RRM}	1200	V
連続DC電流 Continuous DC forward current		I_F	150	A
ピーク繰返し順電流 Repetitive peak forward current	$t_p = 1\text{ ms}$	I_{FRM}	300	A
電流二乗時間積 I^2t - value	$V_R = 0\text{ V}, t_p = 10\text{ ms}, T_{vj} = 125^{\circ}\text{C}$ $V_R = 0\text{ V}, t_p = 10\text{ ms}, T_{vj} = 150^{\circ}\text{C}$	I^2t	3050 2950	A^2s A^2s

電気的特性 / Characteristic Values

		min.	typ.	max.		
順電圧 Forward voltage	$I_F = 150\text{ A}, V_{GE} = 0\text{ V}$ $I_F = 150\text{ A}, V_{GE} = 0\text{ V}$ $I_F = 150\text{ A}, V_{GE} = 0\text{ V}$	$T_{vj} = 25^{\circ}\text{C}$ $T_{vj} = 125^{\circ}\text{C}$ $T_{vj} = 150^{\circ}\text{C}$	V_F	1,70 1,65 1,65	2,15	V V V
ピーク逆回復電流 Peak reverse recovery current	$I_F = 150\text{ A}, -di_F/dt = 1600\text{ A}/\mu\text{s} (T_{vj}=150^{\circ}\text{C})$ $V_R = 600\text{ V}$ $V_{GE} = -15\text{ V}$	$T_{vj} = 25^{\circ}\text{C}$ $T_{vj} = 125^{\circ}\text{C}$ $T_{vj} = 150^{\circ}\text{C}$	I_{RM}	57,0 73,0 78,0		A A A
逆回復電荷量 Recovered charge	$I_F = 150\text{ A}, -di_F/dt = 1600\text{ A}/\mu\text{s} (T_{vj}=150^{\circ}\text{C})$ $V_R = 600\text{ V}$ $V_{GE} = -15\text{ V}$	$T_{vj} = 25^{\circ}\text{C}$ $T_{vj} = 125^{\circ}\text{C}$ $T_{vj} = 150^{\circ}\text{C}$	Q_r	9,80 19,5 22,0		μC μC μC
逆回復損失 Reverse recovery energy	$I_F = 150\text{ A}, -di_F/dt = 1600\text{ A}/\mu\text{s} (T_{vj}=150^{\circ}\text{C})$ $V_R = 600\text{ V}$ $V_{GE} = -15\text{ V}$	$T_{vj} = 25^{\circ}\text{C}$ $T_{vj} = 125^{\circ}\text{C}$ $T_{vj} = 150^{\circ}\text{C}$	E_{rec}	2,60 5,20 6,20		mJ mJ mJ
ジャンクション・ヒートシンク間熱抵抗 Thermal resistance, junction to heatsink	/Diode (1 素子当り) / per diode valid with IFX pre-applied thermal interface material		R_{thJH}		0,407	K/W
動作温度 Temperature under switching conditions			$T_{vj\text{ op}}$	-40	150	$^{\circ}\text{C}$

Diode、整流器 / Diode, Rectifier 最大定格 / Maximum Rated Values

ピーク繰返し逆電圧 Repetitive peak reverse voltage	$T_{vj} = 25^{\circ}\text{C}$	V_{RRM}	1600	V
最大実効順電流/chip Maximum RMS forward current per chip	$T_H = 100^{\circ}\text{C}$	I_{FRMSM}	150	A
整流出力の最大実効電流 Maximum RMS current at rectifier output	$T_H = 100^{\circ}\text{C}$	I_{RMSM}	150	A
サージ順電流 Surge forward current	$t_p = 10\text{ ms}, T_{vj} = 25^{\circ}\text{C}$ $t_p = 10\text{ ms}, T_{vj} = 150^{\circ}\text{C}$	I_{FSM}	1600 1400	A A
電流二乗時間積 I^2t - value	$t_p = 10\text{ ms}, T_{vj} = 25^{\circ}\text{C}$ $t_p = 10\text{ ms}, T_{vj} = 150^{\circ}\text{C}$	I^2t	13000 9800	A^2s A^2s

電気的特性 / Characteristic Values

		min.	typ.	max.		
順電圧 Forward voltage	$T_{vj} = 150^{\circ}\text{C}, I_F = 150\text{ A}$	V_F	1,00		V	
逆電流 Reverse current	$T_{vj} = 150^{\circ}\text{C}, V_R = 1600\text{ V}$	I_R	1,00		mA	
ジャンクション・ヒートシンク間熱抵抗 Thermal resistance, junction to heatsink	/Diode (1 素子当り) / per diode valid with IFX pre-applied thermal interface material		R_{thJH}		0,356	K/W
動作温度 Temperature under switching conditions			$T_{vj\text{ op}}$	-40	150	$^{\circ}\text{C}$

IGBT-ブレーキチョッパー / IGBT, Brake-Chopper

最大定格 / Maximum Rated Values

コレクタ・エミッタ間電圧 Collector-emitter voltage	$T_{vj} = 25^{\circ}\text{C}$	V_{CES}	1200	V
連続DCコレクタ電流 Continuous DC collector current	$T_H = 90^{\circ}\text{C}, T_{vj\max} = 175^{\circ}\text{C}$	$I_{C\text{nom}}$	100	A
繰り返しピークコレクタ電流 Repetitive peak collector current	$t_p = 1\text{ ms}$	I_{CRM}	200	A
ゲート・エミッタ間ピーク電圧 Gate-emitter peak voltage		V_{GES}	+/-20	V

電気的特性 / Characteristic Values

		min.	typ.	max.	
コレクタ・エミッタ間飽和電圧 Collector-emitter saturation voltage	$I_C = 100\text{ A}, V_{GE} = 15\text{ V}$ $I_C = 100\text{ A}, V_{GE} = 15\text{ V}$ $I_C = 100\text{ A}, V_{GE} = 15\text{ V}$	$T_{vj} = 25^{\circ}\text{C}$ $T_{vj} = 125^{\circ}\text{C}$ $T_{vj} = 150^{\circ}\text{C}$	$V_{CE\text{sat}}$	1,75 2,05 2,10	2,10 V V V
ゲート・エミッタ間しきい値電圧 Gate threshold voltage	$I_C = 3,80\text{ mA}, V_{CE} = V_{GE}, T_{vj} = 25^{\circ}\text{C}$		V_{GEth}	5,25 5,80 6,35	V
ゲート電荷量 Gate charge	$V_{GE} = -15\text{ V} \dots +15\text{ V}$		Q_G	0,80	μC
内蔵ゲート抵抗 Internal gate resistor	$T_{vj} = 25^{\circ}\text{C}$		R_{Gint}	7,5	Ω
入力容量 Input capacitance	$f = 1\text{ MHz}, T_{vj} = 25^{\circ}\text{C}, V_{CE} = 25\text{ V}, V_{GE} = 0\text{ V}$		C_{ies}	6,30	nF
帰還容量 Reverse transfer capacitance	$f = 1\text{ MHz}, T_{vj} = 25^{\circ}\text{C}, V_{CE} = 25\text{ V}, V_{GE} = 0\text{ V}$		C_{res}	0,27	nF
コレクタ・エミッタ間遮断電流 Collector-emitter cut-off current	$V_{CE} = 1200\text{ V}, V_{GE} = 0\text{ V}, T_{vj} = 25^{\circ}\text{C}$		I_{CES}		1,0 mA
ゲート・エミッタ間漏れ電流 Gate-emitter leakage current	$V_{CE} = 0\text{ V}, V_{GE} = 20\text{ V}, T_{vj} = 25^{\circ}\text{C}$		I_{GES}		100 nA
ターンオン遅れ時間 (誘導負荷) Turn-on delay time, inductive load	$I_C = 100\text{ A}, V_{CE} = 600\text{ V}$ $V_{GE} = \pm 15\text{ V}$ $R_{Gon} = 1,6\ \Omega$	$T_{vj} = 25^{\circ}\text{C}$ $T_{vj} = 125^{\circ}\text{C}$ $T_{vj} = 150^{\circ}\text{C}$	t_{don}	0,15 0,16 0,16	μs μs μs
ターンオン上昇時間 (誘導負荷) Rise time, inductive load	$I_C = 100\text{ A}, V_{CE} = 600\text{ V}$ $V_{GE} = \pm 15\text{ V}$ $R_{Gon} = 1,6\ \Omega$	$T_{vj} = 25^{\circ}\text{C}$ $T_{vj} = 125^{\circ}\text{C}$ $T_{vj} = 150^{\circ}\text{C}$	t_r	0,03 0,04 0,04	μs μs μs
ターンオフ遅れ時間 (誘導負荷) Turn-off delay time, inductive load	$I_C = 100\text{ A}, V_{CE} = 600\text{ V}$ $V_{GE} = \pm 15\text{ V}$ $R_{Goff} = 1,6\ \Omega$	$T_{vj} = 25^{\circ}\text{C}$ $T_{vj} = 125^{\circ}\text{C}$ $T_{vj} = 150^{\circ}\text{C}$	t_{doff}	0,31 0,35 0,37	μs μs μs
ターンオフ下降時間 (誘導負荷) Fall time, inductive load	$I_C = 100\text{ A}, V_{CE} = 600\text{ V}$ $V_{GE} = \pm 15\text{ V}$ $R_{Goff} = 1,6\ \Omega$	$T_{vj} = 25^{\circ}\text{C}$ $T_{vj} = 125^{\circ}\text{C}$ $T_{vj} = 150^{\circ}\text{C}$	t_f	0,10 0,16 0,21	μs μs μs
ターンオンスイッチング損失 Turn-on energy loss per pulse	$I_C = 100\text{ A}, V_{CE} = 600\text{ V}, L_S = 35\text{ nH}$ $V_{GE} = \pm 15\text{ V}, di/dt = 2300\text{ A}/\mu\text{s} (T_{vj} = 150^{\circ}\text{C})$ $R_{Gon} = 1,6\ \Omega$	$T_{vj} = 25^{\circ}\text{C}$ $T_{vj} = 125^{\circ}\text{C}$ $T_{vj} = 150^{\circ}\text{C}$	E_{on}	6,10 9,00 9,70	mJ mJ mJ
ターンオフスイッチング損失 Turn-off energy loss per pulse	$I_C = 100\text{ A}, V_{CE} = 600\text{ V}, L_S = 35\text{ nH}$ $V_{GE} = \pm 15\text{ V}, du/dt = 3700\text{ V}/\mu\text{s} (T_{vj} = 150^{\circ}\text{C})$ $R_{Goff} = 1,6\ \Omega$	$T_{vj} = 25^{\circ}\text{C}$ $T_{vj} = 125^{\circ}\text{C}$ $T_{vj} = 150^{\circ}\text{C}$	E_{off}	6,10 9,20 10,0	mJ mJ mJ
短絡電流 SC data	$V_{GE} \leq 15\text{ V}, V_{CC} = 800\text{ V}$ $V_{CE\max} = V_{CES} - L_{SCE} \cdot di/dt$ $t_p \leq 10\ \mu\text{s}, T_{vj} = 150^{\circ}\text{C}$		I_{SC}	360	A
ジャンクション・ヒートシンク間熱抵抗 Thermal resistance, junction to heatsink	IGBT部 (1素子当り) / per IGBT valid with IFX pre-applied thermal interface material		R_{thJH}		0,308 K/W
動作温度 Temperature under switching conditions			$T_{vj\text{op}}$	-40	150 $^{\circ}\text{C}$

Diode、ブレーキチョッパー / Diode, Brake-Chopper 最大定格 / Maximum Rated Values

ピーク繰返し逆電圧 Repetitive peak reverse voltage	$T_{vj} = 25^{\circ}\text{C}$	V_{RRM}	1200	V
連続DC電流 Continuous DC forward current		I_F	50	A
ピーク繰返し順電流 Repetitive peak forward current	$t_P = 1 \text{ ms}$	I_{FRM}	100	A
電流二乗時間積 I^2t - value	$V_R = 0 \text{ V}, t_P = 10 \text{ ms}, T_{vj} = 125^{\circ}\text{C}$ $V_R = 0 \text{ V}, t_P = 10 \text{ ms}, T_{vj} = 150^{\circ}\text{C}$	I^2t	560 475	A^2s A^2s

電気的特性 / Characteristic Values

		min.	typ.	max.	
順電圧 Forward voltage	$I_F = 50 \text{ A}, V_{GE} = 0 \text{ V}$ $I_F = 50 \text{ A}, V_{GE} = 0 \text{ V}$ $I_F = 50 \text{ A}, V_{GE} = 0 \text{ V}$	$T_{vj} = 25^{\circ}\text{C}$ $T_{vj} = 125^{\circ}\text{C}$ $T_{vj} = 150^{\circ}\text{C}$	V_F	1,70 1,65 1,65	2,15 V V V
ピーク逆回復電流 Peak reverse recovery current	$I_F = 50 \text{ A}, -di_F/dt = 2300 \text{ A}/\mu\text{s} (T_{vj}=150^{\circ}\text{C})$ $V_R = 600 \text{ V}$ $V_{GE} = 15 \text{ V}$	$T_{vj} = 25^{\circ}\text{C}$ $T_{vj} = 125^{\circ}\text{C}$ $T_{vj} = 150^{\circ}\text{C}$	I_{RM}	76,0 77,0 77,0	A A A
逆回復電荷量 Recovered charge	$I_F = 50 \text{ A}, -di_F/dt = 2300 \text{ A}/\mu\text{s} (T_{vj}=150^{\circ}\text{C})$ $V_R = 600 \text{ V}$ $V_{GE} = 15 \text{ V}$	$T_{vj} = 25^{\circ}\text{C}$ $T_{vj} = 125^{\circ}\text{C}$ $T_{vj} = 150^{\circ}\text{C}$	Q_r	5,70 9,40 10,5	μC μC μC
逆回復損失 Reverse recovery energy	$I_F = 50 \text{ A}, -di_F/dt = 2300 \text{ A}/\mu\text{s} (T_{vj}=150^{\circ}\text{C})$ $V_R = 600 \text{ V}$ $V_{GE} = 15 \text{ V}$	$T_{vj} = 25^{\circ}\text{C}$ $T_{vj} = 125^{\circ}\text{C}$ $T_{vj} = 150^{\circ}\text{C}$	E_{rec}	2,00 3,50 3,80	mJ mJ mJ
ジャンクション・ヒートシンク間熱抵抗 Thermal resistance, junction to heatsink	/Diode (1 素子当り) / per diode valid with IFX pre-applied thermal interface material		R_{thJH}		0,810 K/W
動作温度 Temperature under switching conditions		$T_{vj op}$	-40	150	$^{\circ}\text{C}$

NTC-サーミスタ / NTC-Thermistor

電気的特性 / Characteristic Values

		min.	typ.	max.	
定格抵抗値 Rated resistance	$T_{NTC} = 25^{\circ}\text{C}$	R_{25}	5,00		k Ω
R100の偏差 Deviation of R100	$T_{NTC} = 100^{\circ}\text{C}, R_{100} = 493 \Omega$	$\Delta R/R$	-5	5	%
損失 Power dissipation	$T_{NTC} = 25^{\circ}\text{C}$	P_{25}		20,0	mW
B-定数 B-value	$R_2 = R_{25} \exp [B_{25/50}(1/T_2 - 1/(298,15 \text{ K}))]$	$B_{25/50}$	3375		K
B-定数 B-value	$R_2 = R_{25} \exp [B_{25/80}(1/T_2 - 1/(298,15 \text{ K}))]$	$B_{25/80}$	3411		K
B-定数 B-value	$R_2 = R_{25} \exp [B_{25/100}(1/T_2 - 1/(298,15 \text{ K}))]$	$B_{25/100}$	3433		K

適切なアプリケーションノートによる仕様
Specification according to the valid application note.

モジュール / Module

絶縁耐圧 Isolation test voltage	RMS, f = 50 Hz, t = 1 min.	V _{ISOL}	2,5		kV
ベースプレート材質 Material of module baseplate			Cu		
内部絶縁 Internal isolation	基礎絶縁 (クラス1, IEC 61140) basic insulation (class 1, IEC 61140)		Al ₂ O ₃		
沿面距離 Creepage distance	連絡方法 - ヒートシンク / terminal to heatsink 連絡方法 - 連絡方法 / terminal to terminal		10,0 5,0		mm
空間距離 Clearance	連絡方法 - ヒートシンク / terminal to heatsink 連絡方法 - 連絡方法 / terminal to terminal		7,5 4,0		mm
相対トラッキング指数 Comperative tracking index		CTI	> 200		
			min.	typ.	max.
内部インダクタンス Stray inductance module		L _{sCE}		25	nH
パワーターミナル・チップ間抵抗 Module lead resistance, terminals - chip	T _H = 25°C, /スイッチ / per switch	R _{CC+EE'}		1,10	mΩ
保存温度 Storage temperature		T _{stg}	-40		125 °C
最大ベース・プレート動作温度 Maximum baseplate operation temperature		T _{BPmax}			125 °C
取り付けネジ締め付けトルク Mounting torque for modul mounting	取り付けネジ M5 適切なアプリケーションノートによるマウンティング Screw M5 - Mounting according to valid application note	M	3,00		6,00 Nm
質量 Weight		G		300	g

Lagerung und Transport von Modulen mit TIM => siehe AN2012-07
Storage and shipment of modules with TIM => see AN2012-07

出力特性 IGBT- インバータ (Typical)
output characteristic IGBT, Inverter (typical)

$I_C = f(V_{CE})$
 $V_{GE} = 15\text{ V}$

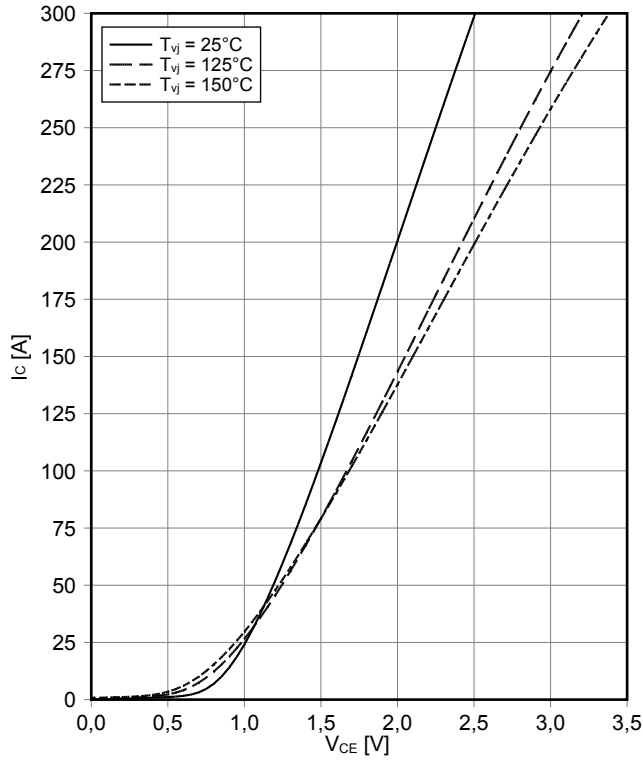

出力特性 IGBT- インバータ (Typical)
output characteristic IGBT, Inverter (typical)

$I_C = f(V_{CE})$
 $T_{vj} = 150^\circ\text{C}$

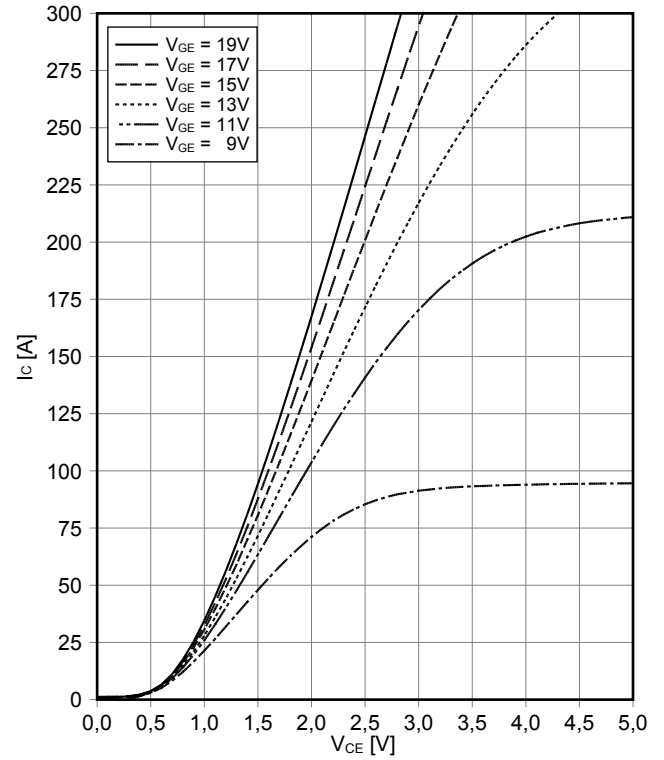

伝達特性 IGBT- インバータ (Typical)
transfer characteristic IGBT, Inverter (typical)

$I_C = f(V_{GE})$
 $V_{CE} = 20\text{ V}$

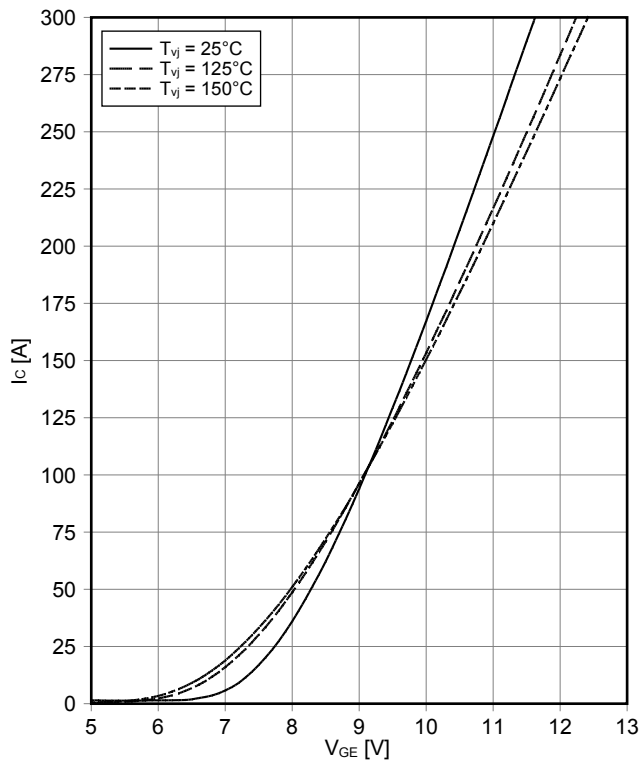

スイッチング損失 IGBT- インバータ (Typical)
switching losses IGBT, Inverter (typical)

$E_{on} = f(I_C)$, $E_{off} = f(I_C)$
 $V_{GE} = \pm 15\text{ V}$, $R_{Gon} = 6.8\ \Omega$, $R_{Goff} = 6.8\ \Omega$, $V_{CE} = 600\text{ V}$

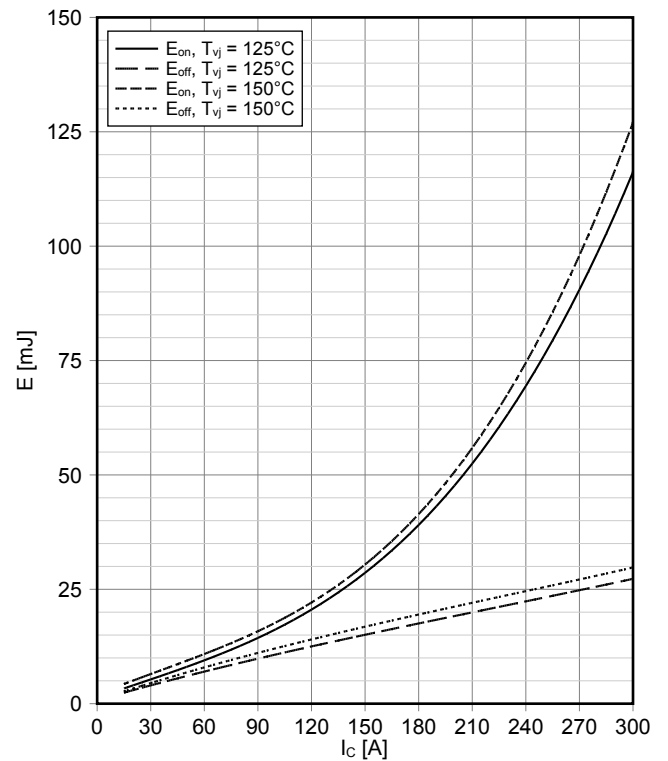

スイッチング損失 IGBT- インバータ (Typical)
switching losses IGBT, Inverter (typical)

$E_{on} = f(R_G)$, $E_{off} = f(R_G)$
 $V_{GE} = \pm 15\text{ V}$, $I_C = 150\text{ A}$, $V_{CE} = 600\text{ V}$

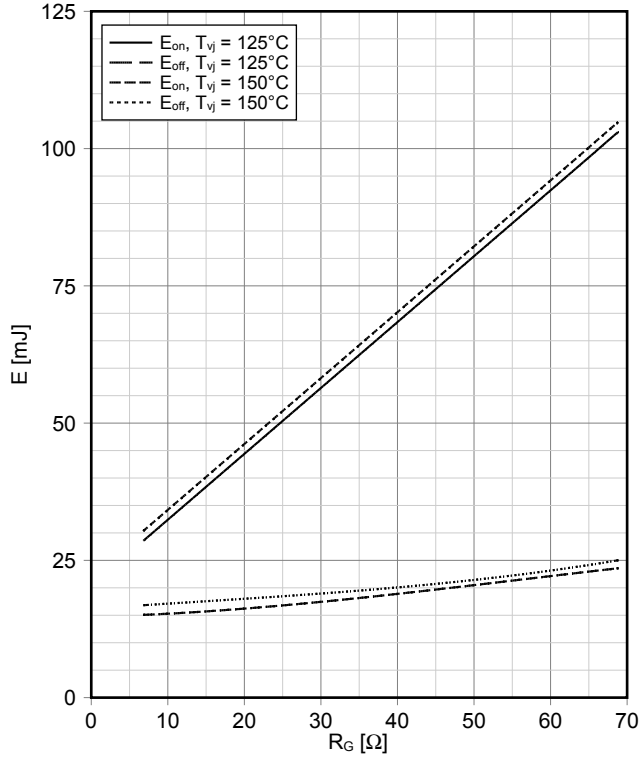

過渡熱インピーダンス IGBT- インバータ
transient thermal impedance IGBT, Inverter

$Z_{thJH} = f(t)$

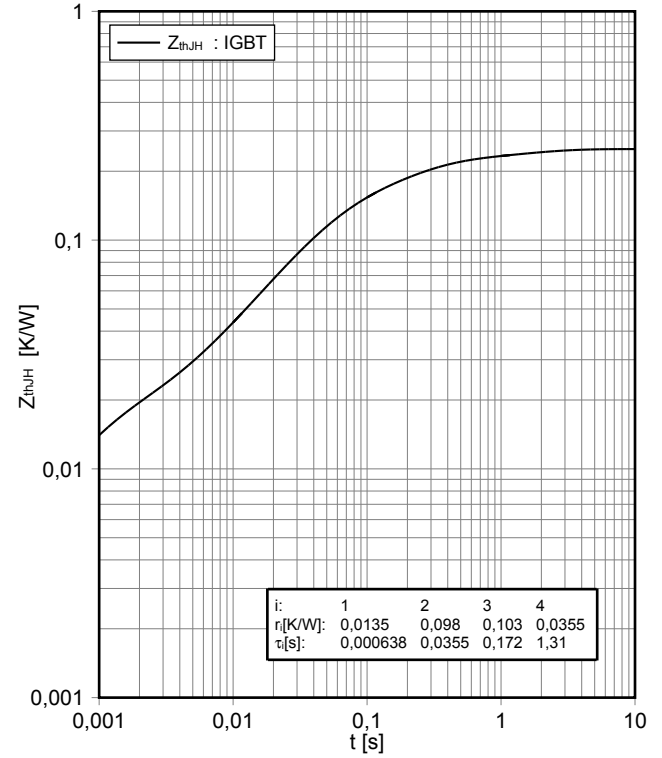

逆バイアス安全動作領域 IGBT- インバータ (RBSOA)
reverse bias safe operating area IGBT, Inverter (RBSOA)

$I_C = f(V_{CE})$
 $V_{GE} = \pm 15\text{ V}$, $R_{Goff} = 6.8\ \Omega$, $T_{vj} = 150^\circ\text{C}$

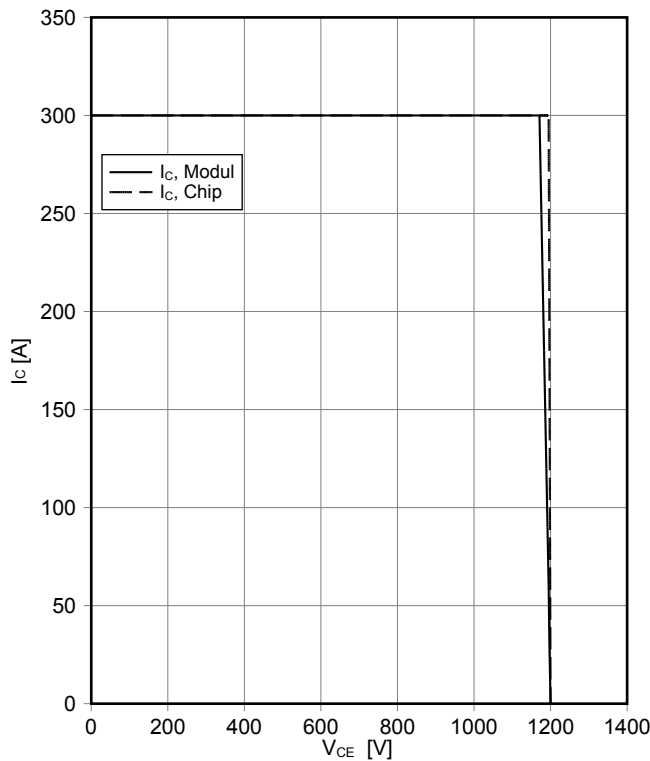

順電圧特性 Diode、インバータ (typical)
forward characteristic of Diode, Inverter (typical)

$I_F = f(V_F)$

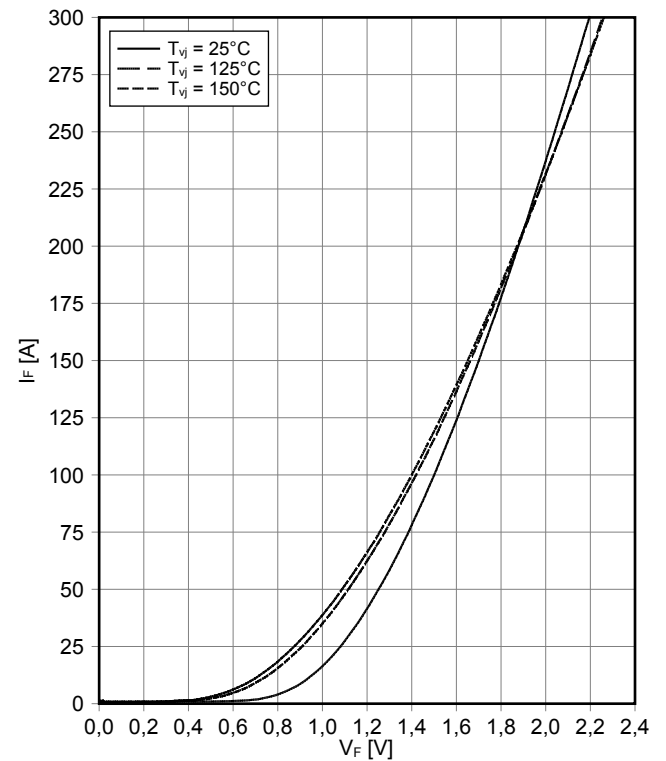

スイッチング損失 Diode、インバータ (Typical)
switching losses Diode, Inverter (typical)

$E_{rec} = f(I_F)$
 $R_{Gon} = 6.8 \Omega, V_{CE} = 600 V$



スイッチング損失 Diode、インバータ (Typical)
switching losses Diode, Inverter (typical)

$E_{rec} = f(R_G)$
 $I_F = 150 A, V_{CE} = 600 V$

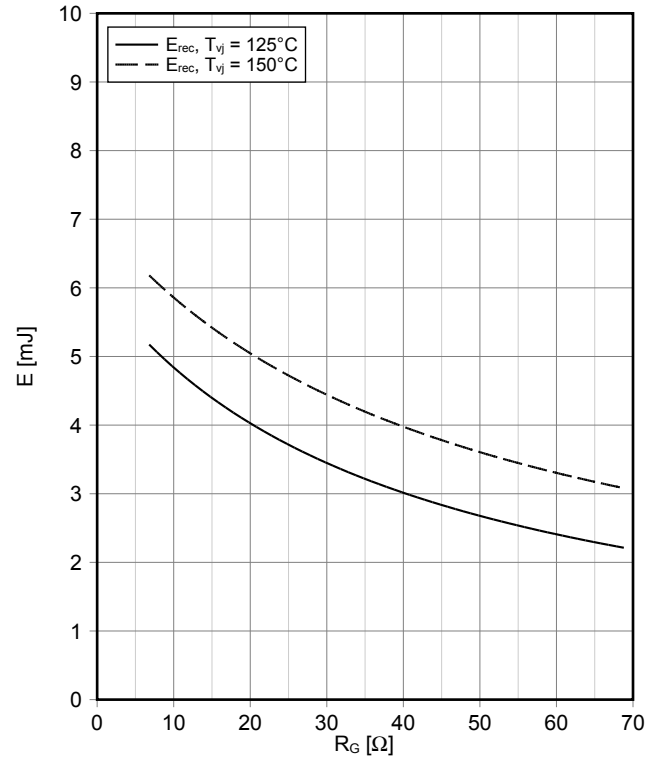

過渡熱インピーダンス Diode、インバータ
transient thermal impedance Diode, Inverter

$Z_{thJH} = f(t)$

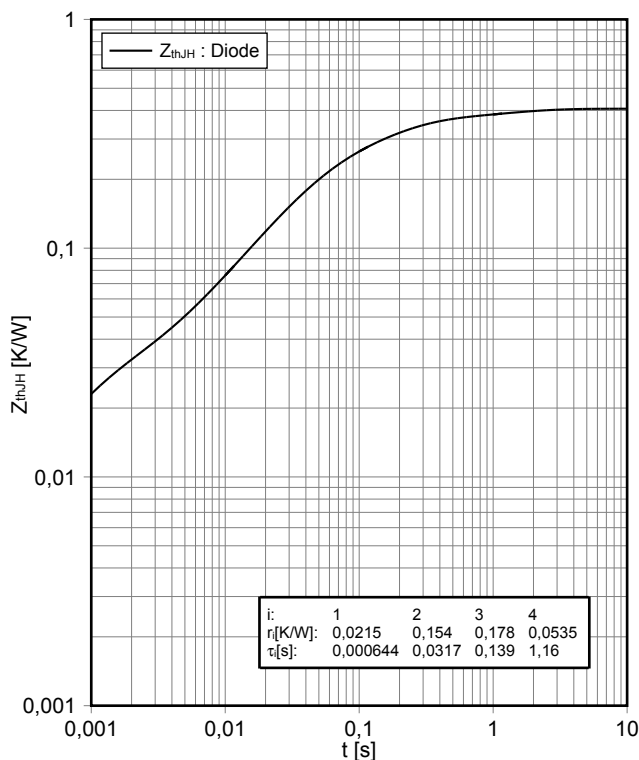

順方向特性 Diode、整流器 (典型)
forward characteristic of Diode, Rectifier (typical)

$I_F = f(V_F)$

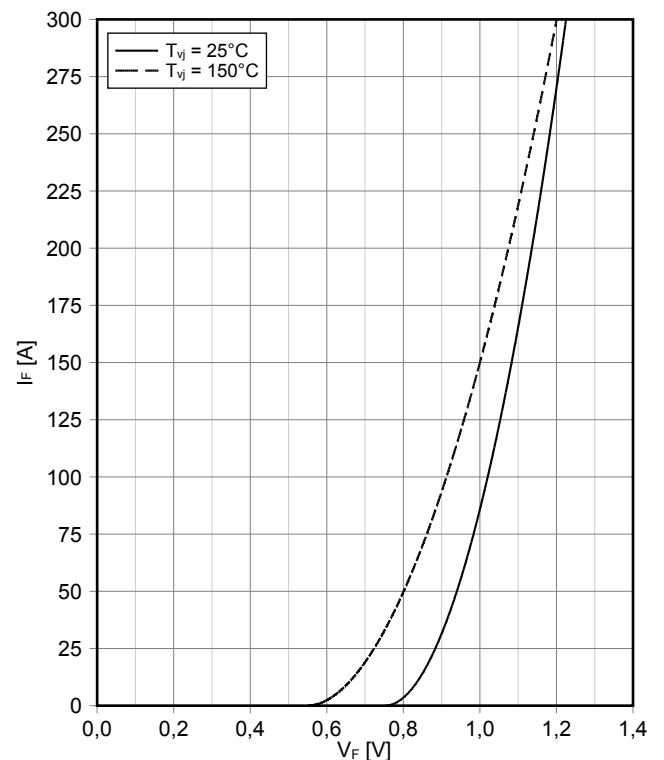

出力特性 IGBT-ブレーキチョッパー (Typical)
output characteristic IGBT, Brake-Chopper (typical)

$I_C = f(V_{CE})$
 $V_{GE} = 15\text{ V}$

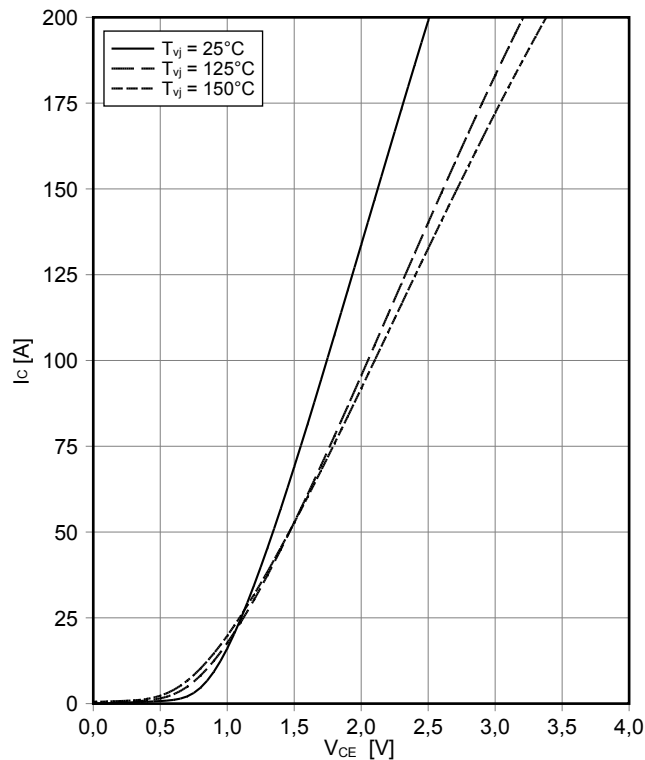

順電圧特性 Diode、ブレーキチョッパー (typical)
forward characteristic of Diode, Brake-Chopper (typical)

$I_F = f(V_F)$

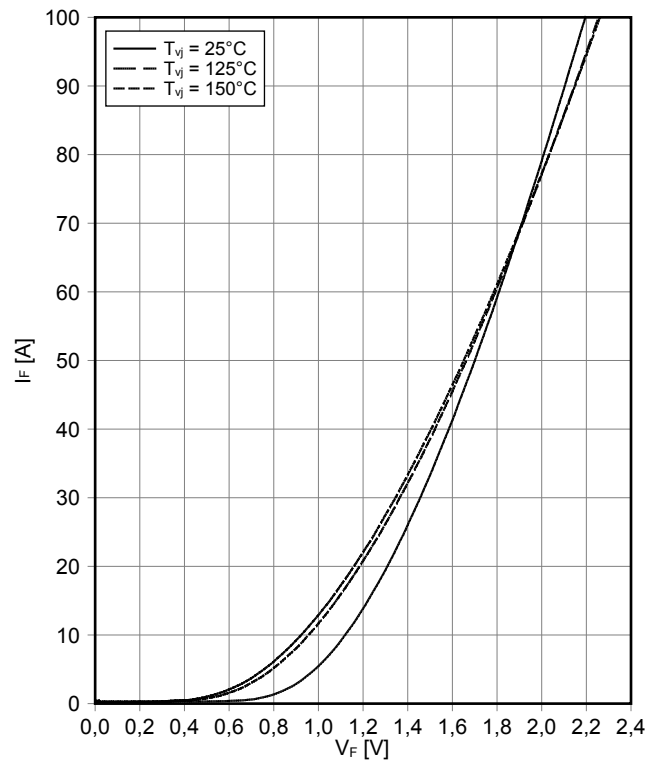

NTC-サーミスタ サーミスタの温度特性
NTC-Thermistor-temperature characteristic (typical)

$R = f(T)$

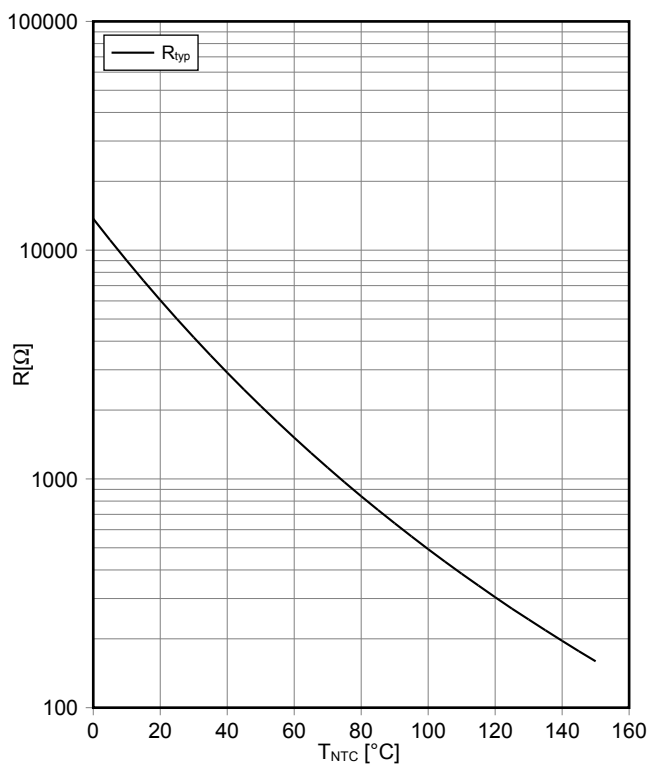

回路図 / Circuit diagram

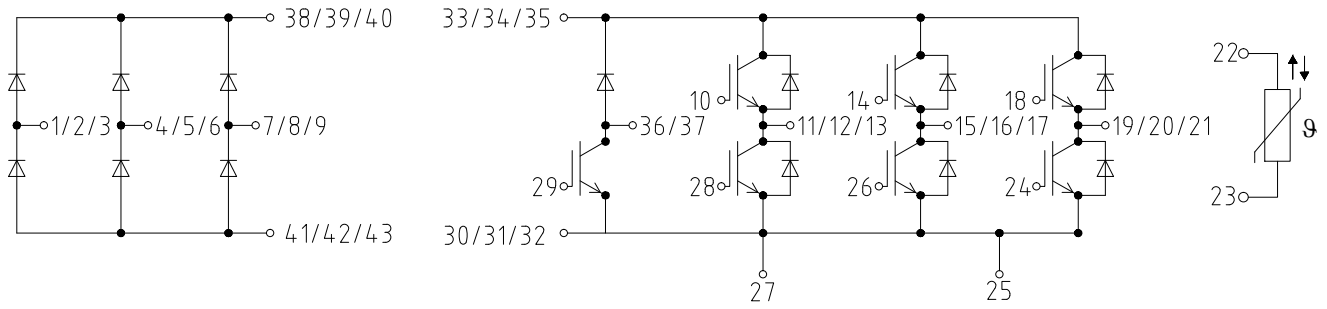

パッケージ概要 / Package outlines

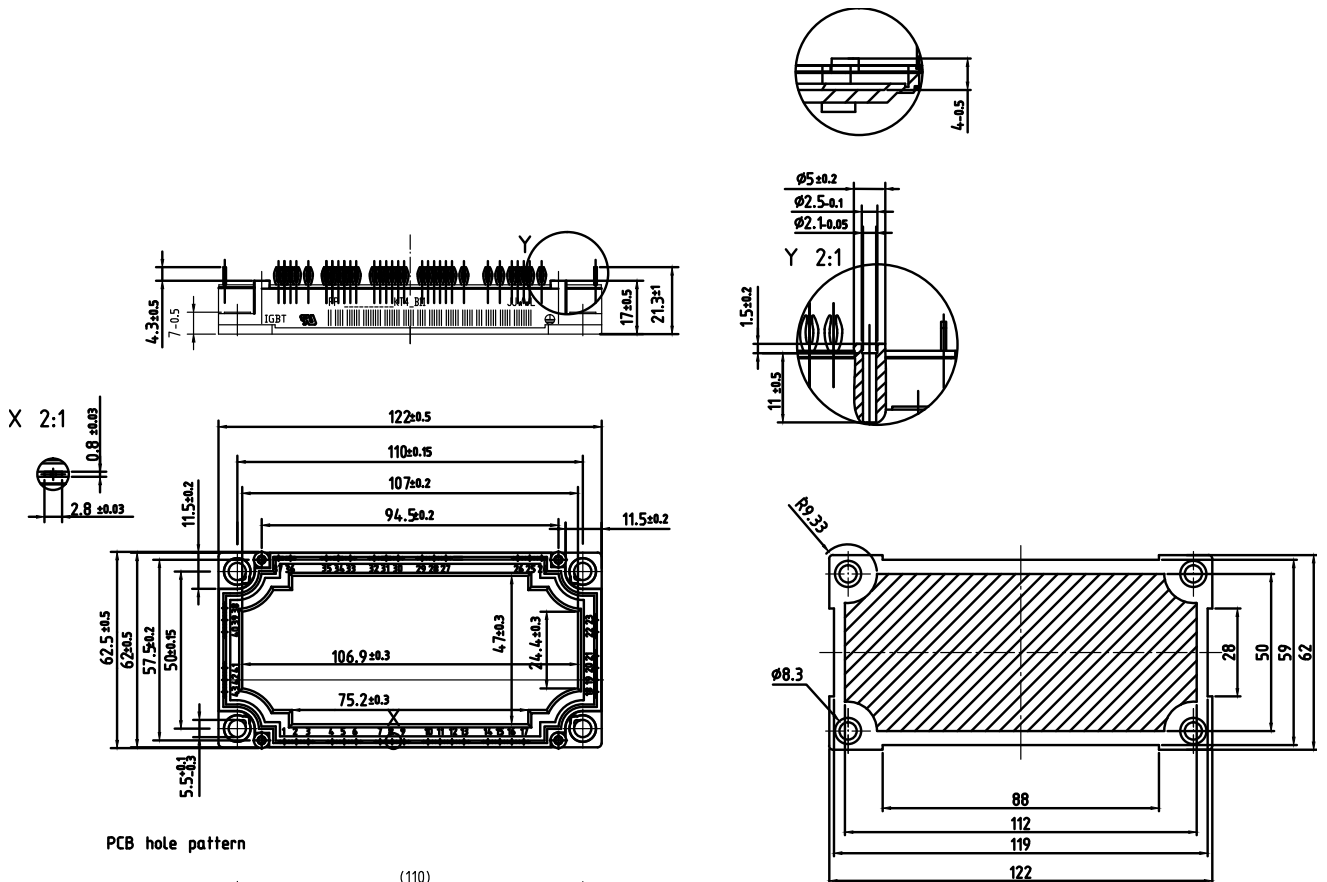

PCB hole pattern

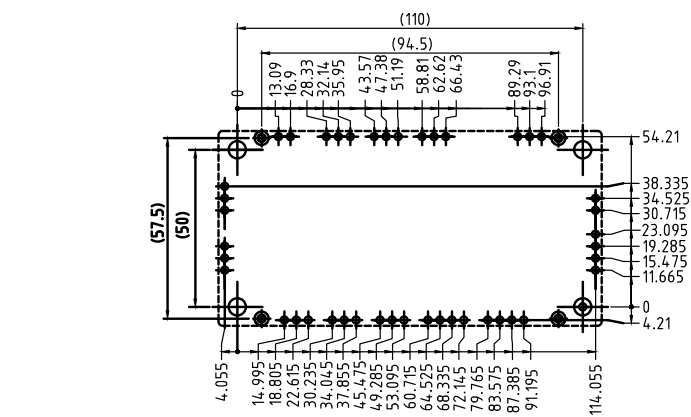

- Tolerance of PCB hole pattern
- hole specifications see AN 2007-09
- Diameters of plated holes ϕ 2.14mm - 2.29mm
- Diameter of drill ϕ 2.35mm

Trademarks

All referenced product or service names and trademarks are the property of their respective owners.

Edition 2017-08-21

Published by
Infineon Technologies AG
81726 München, Germany

© 2017 Infineon Technologies AG.
All Rights Reserved.

Do you have a question about this document?
Email: erratum@infineon.com

重要事項

本文書に記載された情報は、いかなる場合も、条件または特性の保証とみなされるものではありません（「品質の保証」）。本文に記載された一切の事例、手引き、もしくは一般的な価値、および / または本製品の用途に関する一切の情報に関し、インフィニオンテクノロジーズ（以下、「インフィニオン」）はここに、第三者の知的所有権の不侵害の保証を含むがこれに限らず、あらゆる種類の一切の保証および責任を否定いたします。

さらに、本文書に記載された一切の情報は、お客様の用途におけるお客様の製品およびインフィニオン製品の一切の使用に関し、本文書に記載された義務ならびに一切の関連する法的要件、規範、および基準をお客様が遵守することを条件としています。

本文書に含まれるデータは、技術的訓練を受けた従業員のみを対象としています。本製品の対象用途への適合性、およびこれら用途に関連して本文書に記載された製品情報の完全性についての評価は、お客様の技術部門の責任にて実施してください。

本製品、技術、納品条件、および価格についての詳しい情報は、インフィニオンの最寄りの営業所までお問い合わせください（www.infineon.com）。

警告事項

技術的要件に伴い、製品には危険物質が含まれる可能性があります。当該種別の詳細については、インフィニオンの最寄りの営業所までお問い合わせください。

インフィニオンの正式代表者が署名した書面を通じ、インフィニオンによる明示の承認が存在する場合を除き、インフィニオンの製品は、当該製品の障害またはその使用に関する一切の結果が、合理的に人的傷害を招く恐れのある一切の用途に使用することはできないこと予めご了承ください。

IMPORTANT NOTICE

The information given in this document shall in no event be regarded as a guarantee of conditions or characteristics ("Beschaffheitsgarantie"). With respect to any examples, hints or any typical values stated herein and/or any information regarding the application of the product, Infineon Technologies hereby disclaims any and all warranties and liabilities of any kind, including without limitation warranties of non-infringement of intellectual property rights of any third party.

In addition, any information given in this document is subject to customer's compliance with its obligations stated in this document and any applicable legal requirements, norms and standards concerning customer's products and any use of the product of Infineon Technologies in customer's applications.

The data contained in this document is exclusively intended for technically trained staff. It is the responsibility of customer's technical departments to evaluate the suitability of the product for the intended application and the completeness of the product information given in this document with respect to such application.

For further information on the product, technology, delivery terms and conditions and prices please contact your nearest Infineon Technologies office (www.infineon.com).

WARNINGS

Due to technical requirements products may contain dangerous substances. For information on the types in question please contact your nearest Infineon Technologies office.

Except as otherwise explicitly approved by Infineon Technologies in a written document signed by authorized representatives of Infineon Technologies, Infineon Technologies' products may not be used in any applications where a failure of the product or any consequences of the use thereof can reasonably be expected to result in personal injury.