

IHM-B モジュール 高速トレンチ/フィールドストップ IGBT3とエミッターコントロール3ダイオード内蔵
IHM-B module with Trench/Fieldstop IGBT3 and Emitter Controlled 3 diode

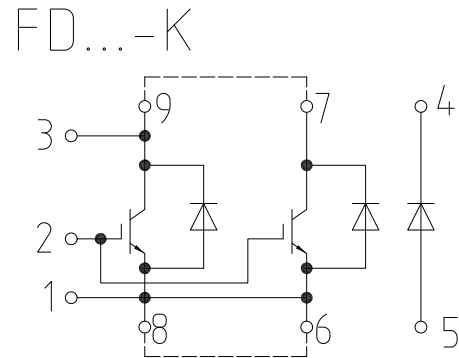

$V_{CES} = 3300V$
 $I_{C\ nom} = 1000A / I_{CRM} = 2000A$

アプリケーションの可能性

- UPSシステム
- チョッパアプリケーション
- モーター駆動
- 中電圧コンバータ
- 電鉄駆動
- 風力タービン

Potential Applications

- UPS systems
- Chopper applications
- Motor drives
- Medium voltage converters
- Traction drives
- Wind turbines

電気的特性

- $T_{vj\ op} = 150^{\circ}C$
- 低 V_{CEsat} 飽和電圧
- 優れたロバスト性
- 正温度特性を持った V_{CEsat} 飽和電圧
- 高いDC電圧での安定性
- 高い短絡耐量

Electrical Features

- $T_{vj\ op} = 150^{\circ}C$
- Low V_{CEsat}
- Unbeatable robustness
- V_{CEsat} with positive temperature coefficient
- High DC stability
- High short-circuit capability

機械的特性

- CTI(比較トラッキング指数) >600のモジュールパッケージ
- IHM Bハウジング
- サーマルサイクル耐量を増加するAlSiCベースプレート
- 絶縁されたベースプレート

Mechanical Features

- Package with CTI > 600
- IHM B housing
- AlSiC base plate for increased thermal cycling capability
- Isolated base plate

Module Label Code

Barcode Code 128



DMX - Code



Content of the Code

Content of the Code	Digit
Module Serial Number	1 - 5
Module Material Number	6 - 11
Production Order Number	12 - 19
Datecode (Production Year)	20 - 21
Datecode (Production Week)	22 - 23

IGBT- インバータ / IGBT, Inverter 最大定格 / Maximum Rated Values

コレクタ・エミッタ間電圧 Collector-emitter voltage	$T_{vj} = -40^{\circ}\text{C}$ $T_{vj} = 150^{\circ}\text{C}$	V_{CES}	3300 3300	V
連続DCコレクタ電流 Continuous DC collector current	$T_C = 95^{\circ}\text{C}$, $T_{vj\max} = 150^{\circ}\text{C}$	I_{CDC}	1000	A
繰り返しピークコレクタ電流 Repetitive peak collector current	$t_P = 1\text{ ms}$	I_{CRM}	2000	A
ゲート・エミッタ間ピーク電圧 Gate-emitter peak voltage		V_{GES}	+/-20	V

電気的特性 / Characteristic Values

		min.	typ.	max.		
コレクタ・エミッタ間飽和電圧 Collector-emitter saturation voltage	$I_C = 1000\text{ A}$ $V_{GE} = 15\text{ V}$		$T_{vj} = 25^{\circ}\text{C}$ 2,40 $T_{vj} = 125^{\circ}\text{C}$ 2,95 $T_{vj} = 150^{\circ}\text{C}$ 3,10	2,85 3,50	V V V	
ゲート・エミッタ間しきい値電圧 Gate threshold voltage	$I_C = 48,0\text{ mA}$, $V_{CE} = V_{GE}$, $T_{vj} = 25^{\circ}\text{C}$		5,20	5,80	6,40	V
ゲート電荷量 Gate charge	$V_{GE} = -15 / 15\text{ V}$, $V_{CE} = 1800\text{ V}$			28,0		μC
内蔵ゲート抵抗 Internal gate resistor	$T_{vj} = 25^{\circ}\text{C}$			0,63		Ω
入力容量 Input capacitance	$f = 1000\text{ kHz}$, $T_{vj} = 25^{\circ}\text{C}$, $V_{CE} = 25\text{ V}$, $V_{GE} = 0\text{ V}$			190		nF
帰還容量 Reverse transfer capacitance	$f = 1000\text{ kHz}$, $T_{vj} = 25^{\circ}\text{C}$, $V_{CE} = 25\text{ V}$, $V_{GE} = 0\text{ V}$			4,00		nF
コレクタ・エミッタ間遮断電流 Collector-emitter cut-off current	$V_{CE} = 3300\text{ V}$, $V_{GE} = 0\text{ V}$, $T_{vj} = 25^{\circ}\text{C}$				5,0	mA
ゲート・エミッタ間漏れ電流 Gate-emitter leakage current	$V_{CE} = 0\text{ V}$, $V_{GE} = 20\text{ V}$, $T_{vj} = 25^{\circ}\text{C}$				400	nA
ターンオン遅れ時間 (誘導負荷) Turn-on delay time, inductive load	$I_C = 1000\text{ A}$, $V_{CE} = 1800\text{ V}$ $V_{GE} = -15 / 15\text{ V}$ $R_{Gon} = 0,75\ \Omega$, $C_{GE} = 220\text{ nF}$		$T_{vj} = 25^{\circ}\text{C}$ $T_{vj} = 125^{\circ}\text{C}$ $T_{vj} = 150^{\circ}\text{C}$	0,36 0,40 0,40		μs μs μs
ターンオン上昇時間 (誘導負荷) Rise time, inductive load	$I_C = 1000\text{ A}$, $V_{CE} = 1800\text{ V}$ $V_{GE} = -15 / 15\text{ V}$ $R_{Gon} = 0,75\ \Omega$, $C_{GE} = 220\text{ nF}$		$T_{vj} = 25^{\circ}\text{C}$ $T_{vj} = 125^{\circ}\text{C}$ $T_{vj} = 150^{\circ}\text{C}$	0,37 0,40 0,40		μs μs μs
ターンオフ遅れ時間 (誘導負荷) Turn-off delay time, inductive load	$I_C = 1000\text{ A}$, $V_{CE} = 1800\text{ V}$ $V_{GE} = -15 / 15\text{ V}$ $R_{Goff} = 4,1\ \Omega$, $C_{GE} = 220\text{ nF}$		$T_{vj} = 25^{\circ}\text{C}$ $T_{vj} = 125^{\circ}\text{C}$ $T_{vj} = 150^{\circ}\text{C}$	4,10 4,30 4,30		μs μs μs
ターンオフ下降時間 (誘導負荷) Fall time, inductive load	$I_C = 1000\text{ A}$, $V_{CE} = 1800\text{ V}$ $V_{GE} = -15 / 15\text{ V}$ $R_{Goff} = 4,1\ \Omega$, $C_{GE} = 220\text{ nF}$		$T_{vj} = 25^{\circ}\text{C}$ $T_{vj} = 125^{\circ}\text{C}$ $T_{vj} = 150^{\circ}\text{C}$	0,40 0,40 0,40		μs μs μs
ターンオンスイッチング損失 Turn-on energy loss per pulse	$I_C = 1000\text{ A}$, $V_{CE} = 1800\text{ V}$, $L_{\sigma} = 85\text{ nH}$ $di/dt = 3000\text{ A}/\mu\text{s}$ ($T_{vj} = 150^{\circ}\text{C}$) $V_{GE} = -15 / 15\text{ V}$, $R_{Gon} = 0,75\ \Omega$ $C_{GE} = 220\text{ nF}$		$T_{vj} = 25^{\circ}\text{C}$ $T_{vj} = 125^{\circ}\text{C}$ $T_{vj} = 150^{\circ}\text{C}$	1550 2150 2400		mJ mJ mJ
ターンオフスイッチング損失 Turn-off energy loss per pulse	$I_C = 1000\text{ A}$, $V_{CE} = 1800\text{ V}$, $L_{\sigma} = 85\text{ nH}$ $du/dt = 1550\text{ V}/\mu\text{s}$ ($T_{vj} = 150^{\circ}\text{C}$) $V_{GE} = -15 / 15\text{ V}$, $R_{Goff} = 4,1\ \Omega$ $C_{GE} = 220\text{ nF}$		$T_{vj} = 25^{\circ}\text{C}$ $T_{vj} = 125^{\circ}\text{C}$ $T_{vj} = 150^{\circ}\text{C}$	1600 1950 2050		mJ mJ mJ
短絡電流 SC data	$V_{GE} \leq 15\text{ V}$, $V_{CC} = 2500\text{ V}$ $V_{CE\max} = V_{CES} - L_{SCE} \cdot di/dt$ $t_P \leq 10\ \mu\text{s}$, $T_{vj} = 150^{\circ}\text{C}$			4300		A
ジャンクション・ケース間熱抵抗 Thermal resistance, junction to case	IGBT部 (1素子当り) / per IGBT				11,0	K/kW
ケース・ヒートシンク間熱抵抗 Thermal resistance, case to heatsink	IGBT部 (1素子当り) / per IGBT $\lambda_{\text{Paste}} = 1\text{ W}/(\text{m}\cdot\text{K})$ / $\lambda_{\text{grease}} = 1\text{ W}/(\text{m}\cdot\text{K})$				14,5	K/kW
動作温度 Temperature under switching conditions			$T_{vj\text{op}}$	-40	150	$^{\circ}\text{C}$

Diode、インバータ / Diode, Inverter

最大定格 / Maximum Rated Values

ピーク繰返し逆電圧 Repetitive peak reverse voltage	$T_{vj} = -40^{\circ}\text{C}$ $T_{vj} = 150^{\circ}\text{C}$	V_{RRM}	3300 3300	V
連続DC電流 Continuous DC forward current		I_F	1000	A
ピーク繰返し順電流 Repetitive peak forward current	$t_P = 1 \text{ ms}$	I_{FRM}	2000	A
電流二乗時間積 I^2t - value	$V_R = 0 \text{ V}, t_P = 10 \text{ ms}, T_{vj} = 125^{\circ}\text{C}$ $V_R = 0 \text{ V}, t_P = 10 \text{ ms}, T_{vj} = 150^{\circ}\text{C}$	I^2t	375 325	kA^2s kA^2s
最大損失 Maximum power dissipation	$T_{vj} = 150^{\circ}\text{C}$	P_{RQM}	1600	kW
最小ターンオン時間 Minimum turn-on time		$t_{on \text{ min}}$	10,0	μs

電気的特性 / Characteristic Values

		min. typ. max.				
順電圧 Forward voltage	$I_F = 1000 \text{ A}, V_{GE} = 0 \text{ V}$ $I_F = 1000 \text{ A}, V_{GE} = 0 \text{ V}$ $I_F = 1000 \text{ A}, V_{GE} = 0 \text{ V}$	$T_{vj} = 25^{\circ}\text{C}$ $T_{vj} = 125^{\circ}\text{C}$ $T_{vj} = 150^{\circ}\text{C}$	V_F	2,25 2,20 2,20	2,85 2,75 V	V V V
ピーク逆回復電流 Peak reverse recovery current	$I_F = 1000 \text{ A}, -di_F/dt = 3000 \text{ A}/\mu\text{s} (T_{vj}=150^{\circ}\text{C})$ $V_R = 1800 \text{ V}$ $V_{GE} = -15 \text{ V}$	$T_{vj} = 25^{\circ}\text{C}$ $T_{vj} = 125^{\circ}\text{C}$ $T_{vj} = 150^{\circ}\text{C}$	I_{RM}	1100 1200 1250		A A A
逆回復電荷量 Recovered charge	$I_F = 1000 \text{ A}, -di_F/dt = 3000 \text{ A}/\mu\text{s} (T_{vj}=150^{\circ}\text{C})$ $V_R = 1800 \text{ V}$ $V_{GE} = -15 \text{ V}$	$T_{vj} = 25^{\circ}\text{C}$ $T_{vj} = 125^{\circ}\text{C}$ $T_{vj} = 150^{\circ}\text{C}$	Q_r	1000 1750 1950		μC μC μC
逆回復損失 Reverse recovery energy	$I_F = 1000 \text{ A}, -di_F/dt = 3000 \text{ A}/\mu\text{s} (T_{vj}=150^{\circ}\text{C})$ $V_R = 1800 \text{ V}$ $V_{GE} = -15 \text{ V}$	$T_{vj} = 25^{\circ}\text{C}$ $T_{vj} = 125^{\circ}\text{C}$ $T_{vj} = 150^{\circ}\text{C}$	E_{rec}	1100 2100 2500		mJ mJ mJ
ジャンクション・ケース間熱抵抗 Thermal resistance, junction to case	/Diode (1 素子当り) / per diode		R_{thJC}		20,0	K/kW
ケース・ヒートシンク間熱抵抗 Thermal resistance, case to heatsink	/Diode (1 素子当り) / per diode $\lambda_{\text{Paste}} = 1 \text{ W}/(\text{m}\cdot\text{K})$ / $\lambda_{\text{grease}} = 1 \text{ W}/(\text{m}\cdot\text{K})$		R_{thCH}	16,5		K/kW
動作温度 Temperature under switching conditions			$T_{vj \text{ op}}$	-40	150	$^{\circ}\text{C}$

Diode、ブレーキチョッパー / Diode, Brake-Chopper

最大定格 / Maximum Rated Values

ピーク繰返し逆電圧 Repetitive peak reverse voltage	$T_{vj} = -40^{\circ}\text{C}$ $T_{vj} = 150^{\circ}\text{C}$	V_{RRM}	3300 3300	V
連続DC電流 Continuous DC forward current		I_F	1000	A
ピーク繰返し順電流 Repetitive peak forward current	$t_P = 1 \text{ ms}$	I_{FRM}	2000	A
電流二乗時間積 I^2t - value	$V_R = 0 \text{ V}, t_P = 10 \text{ ms}, T_{vj} = 125^{\circ}\text{C}$ $V_R = 0 \text{ V}, t_P = 10 \text{ ms}, T_{vj} = 150^{\circ}\text{C}$	I^2t	375 325	kA^2s kA^2s
最大損失 Maximum power dissipation	$T_{vj} = 150^{\circ}\text{C}$	P_{RQM}	1600	kW
最小ターンオン時間 Minimum turn-on time		$t_{on \text{ min}}$	10,0	μs

電気的特性 / Characteristic Values

		min.	typ.	max.		
順電圧 Forward voltage	$I_F = 1000 \text{ A}, V_{GE} = 0 \text{ V}$ $I_F = 1000 \text{ A}, V_{GE} = 0 \text{ V}$ $I_F = 1000 \text{ A}, V_{GE} = 0 \text{ V}$	$T_{vj} = 25^{\circ}\text{C}$ $T_{vj} = 125^{\circ}\text{C}$ $T_{vj} = 150^{\circ}\text{C}$	V_F	2,25 2,20 2,20	2,85 2,75	V V V
ピーク逆回復電流 Peak reverse recovery current	$I_F = 1000 \text{ A}, -di_F/dt = 3000 \text{ A}/\mu\text{s} (T_{vj}=150^{\circ}\text{C})$ $V_R = 1800 \text{ V}$ $V_{GE} = -15 \text{ V}$	$T_{vj} = 25^{\circ}\text{C}$ $T_{vj} = 125^{\circ}\text{C}$ $T_{vj} = 150^{\circ}\text{C}$	I_{RM}	1100 1200 1250		A A A
逆回復電荷量 Recovered charge	$I_F = 1000 \text{ A}, -di_F/dt = 3000 \text{ A}/\mu\text{s} (T_{vj}=150^{\circ}\text{C})$ $V_R = 1800 \text{ V}$ $V_{GE} = -15 \text{ V}$	$T_{vj} = 25^{\circ}\text{C}$ $T_{vj} = 125^{\circ}\text{C}$ $T_{vj} = 150^{\circ}\text{C}$	Q_r	1000 1750 1950		μC μC μC
逆回復損失 Reverse recovery energy	$I_F = 1000 \text{ A}, -di_F/dt = 3000 \text{ A}/\mu\text{s} (T_{vj}=150^{\circ}\text{C})$ $V_R = 1800 \text{ V}$ $V_{GE} = -15 \text{ V}$	$T_{vj} = 25^{\circ}\text{C}$ $T_{vj} = 125^{\circ}\text{C}$ $T_{vj} = 150^{\circ}\text{C}$	E_{rec}	1100 2100 2500		mJ mJ mJ
ジャンクション・ケース間熱抵抗 Thermal resistance, junction to case	/Diode (1 素子当り) / per diode		R_{thJC}		21,5	K/kW
ケース・ヒートシンク間熱抵抗 Thermal resistance, case to heatsink	/Diode (1 素子当り) / per diode $\lambda_{\text{Paste}} = 1 \text{ W}/(\text{m}\cdot\text{K})$ / $\lambda_{\text{grease}} = 1 \text{ W}/(\text{m}\cdot\text{K})$		R_{thCH}		16,5	K/kW
動作温度 Temperature under switching conditions			$T_{vj \text{ op}}$	-40	150	$^{\circ}\text{C}$

モジュール / Module

絶縁耐圧 Isolation test voltage	RMS, f = 50 Hz, t = 1 min.	V _{ISOL}	6,0		kV
部分放電電圧 Partial discharge extinction voltage	RMS, f = 50 Hz, Q _{PD} ≤ 10 pC	V _{ISOL}	2,6		kV
DCスタビリティ DC stability	T _{vj} = 25°C, 100 fit	V _{CE D}	2100		V
ベースプレート材質 Material of module baseplate			AISiC		
沿面距離 Creepage distance	連絡方法 - ヒートシンク / terminal to heatsink 連絡方法 - 連絡方法 / terminal to terminal		32,2		mm
空間距離 Clearance	連絡方法 - ヒートシンク / terminal to heatsink 連絡方法 - 連絡方法 / terminal to terminal		19,1		mm
相対トラッキング指数 Comperative tracking index		CTI	> 600		
min. typ. max.					
内部インダクタンス Stray inductance module		L _{sCE}	9,0		nH
パワーターミナル・チップ間抵抗 Module lead resistance, terminals - chip	T _c = 25°C, /スイッチ / per switch	R _{CC'+EE'} R _{AA'+CC'}	0,19 0,28		mΩ
保存温度 Storage temperature		T _{stg}	-40	150	°C
取り付けネジ締め付けトルク Mounting torque for modul mounting	取り付けネジ M6 適切なアプリケーションノートによるマウンティング Screw M6 - Mounting according to valid application note	M	4,25		5,75 Nm
主端子ネジ締め付けトルク Terminal connection torque	取り付けネジ M4 適切なアプリケーションノートによるマウンティング Screw M4 - Mounting according to valid application note 取り付けネジ M8 適切なアプリケーションノートによるマウンティング Screw M8 - Mounting according to valid application note	M	1,8 8,0	- -	2,1 10 Nm
質量 Weight		G	1200		g

Modulinduktivität: IGBT (Zweig 1+2 parallel): 9nH; Diode (Zweig 3): 18nH
 stray inductance module: IGBT (arm 1+2 parallel): 9nH; Diode (arm 3): 18nH

出力特性 IGBT- インバータ (Typical)
output characteristic IGBT, Inverter (typical)

$I_C = f(V_{CE})$
 $V_{GE} = 15\text{ V}$

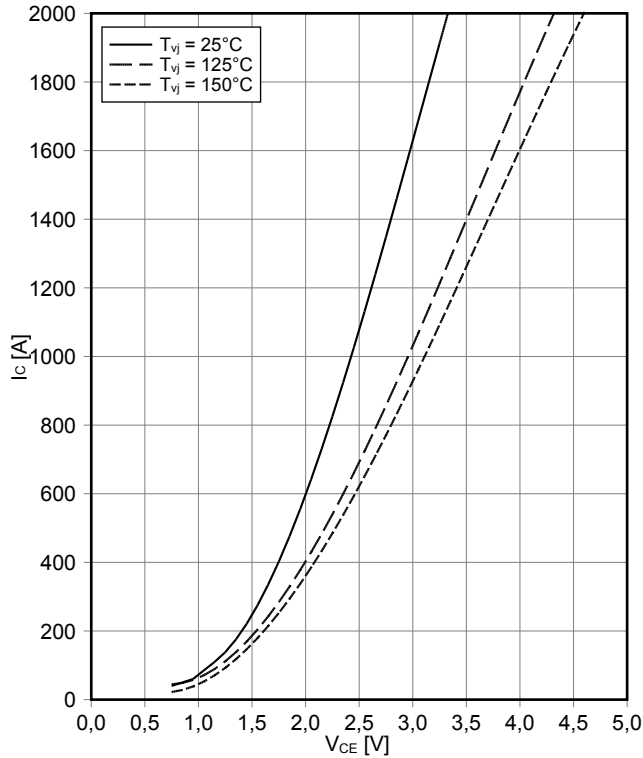

出力特性 IGBT- インバータ (Typical)
output characteristic IGBT, Inverter (typical)

$I_C = f(V_{CE})$
 $T_{vj} = 150^\circ\text{C}$

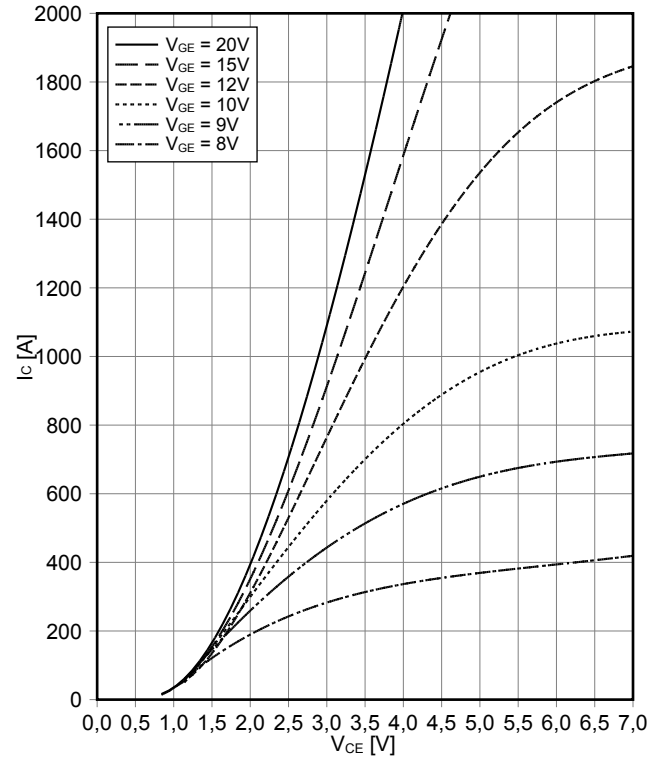

伝達特性 IGBT- インバータ (Typical)
transfer characteristic IGBT, Inverter (typical)

$I_C = f(V_{GE})$
 $V_{CE} = 20\text{ V}$

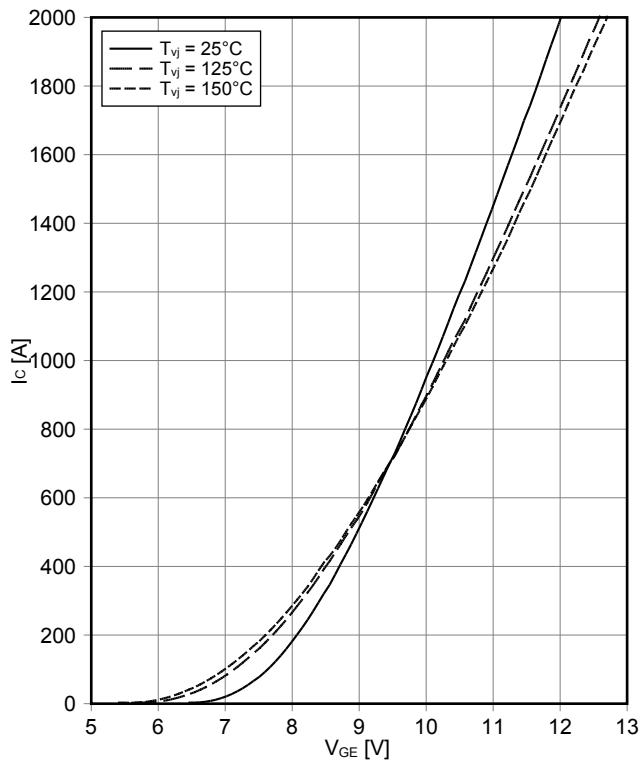

スイッチング損失 IGBT- インバータ (Typical)
switching losses IGBT, Inverter (typical)

$E_{on} = f(I_C)$, $E_{off} = f(I_C)$
 $V_{GE} = \pm 15\text{ V}$, $R_{Gon} = 0.75\ \Omega$, $R_{Goff} = 4.1\ \Omega$, $V_{CE} = 1800\text{ V}$, $C_{GE} = 220\text{ nF}$

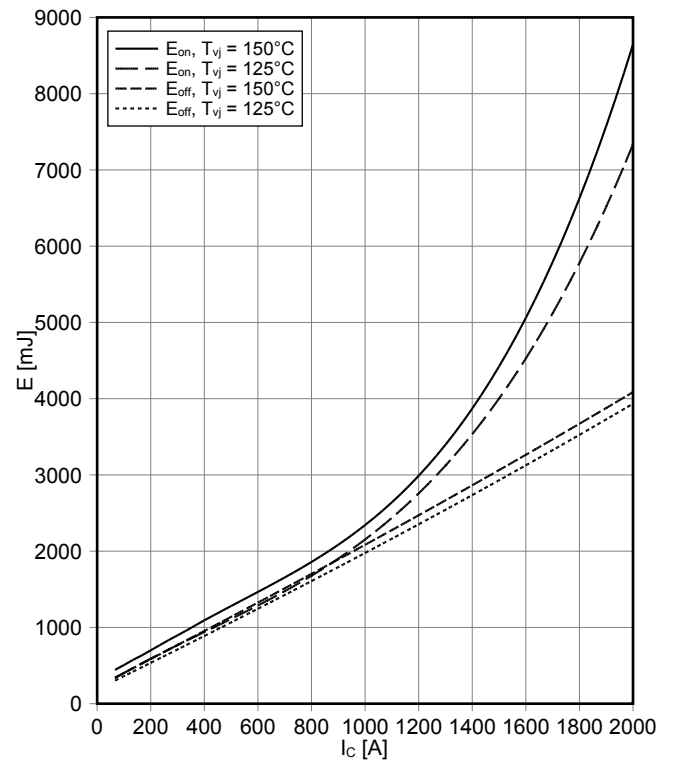

スイッチング損失 IGBT-インバータ (Typical)
switching losses IGBT, Inverter (typical)

$E_{on} = f(R_G)$, $E_{off} = f(R_G)$
 $V_{GE} = \pm 15\text{ V}$, $I_C = 1000\text{ A}$, $V_{CE} = 1800\text{ V}$, $C_{GE} = 220\text{ nF}$

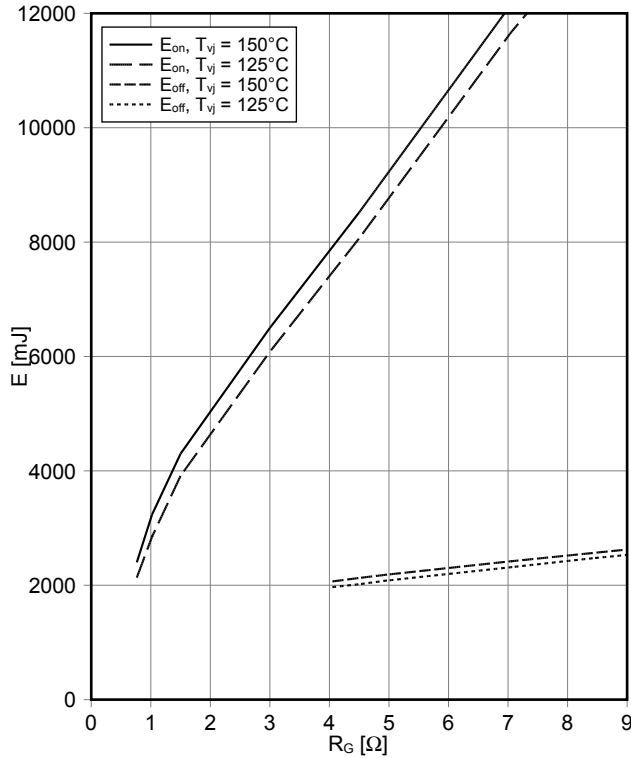

過渡熱インピーダンス IGBT-インバータ
transient thermal impedance IGBT, Inverter
 $Z_{thJC} = f(t)$

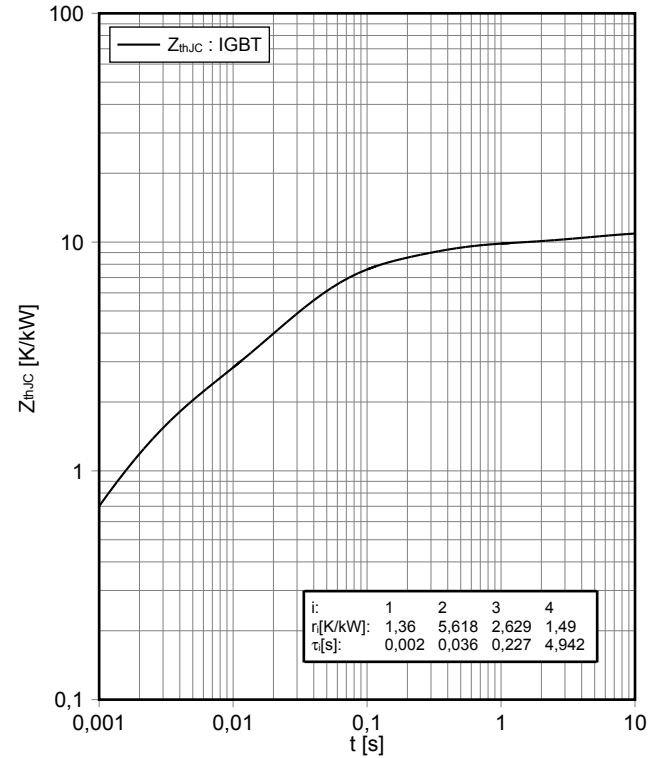

逆バイアス安全動作領域 IGBT-インバータ (RBSOA)
reverse bias safe operating area IGBT, Inverter (RBSOA)

$I_C = f(V_{CE})$
 $V_{GE} = \pm 15\text{ V}$, $R_{Goff} = 4.1\ \Omega$, $T_{vj} = 150^\circ\text{C}$, $C_{GE} = 220\text{ nF}$

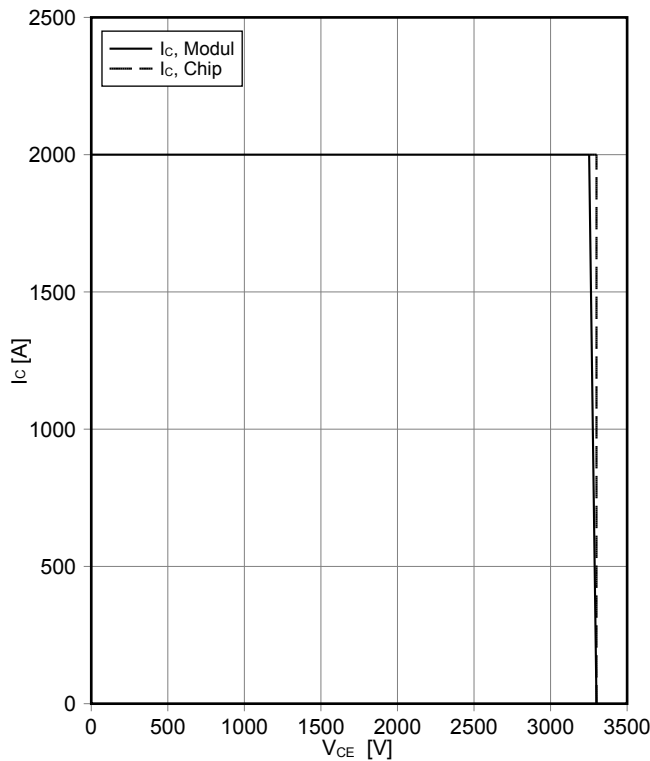

順電圧特性 Diode、インバータ (typical)
forward characteristic of Diode, Inverter (typical)
 $I_F = f(V_F)$

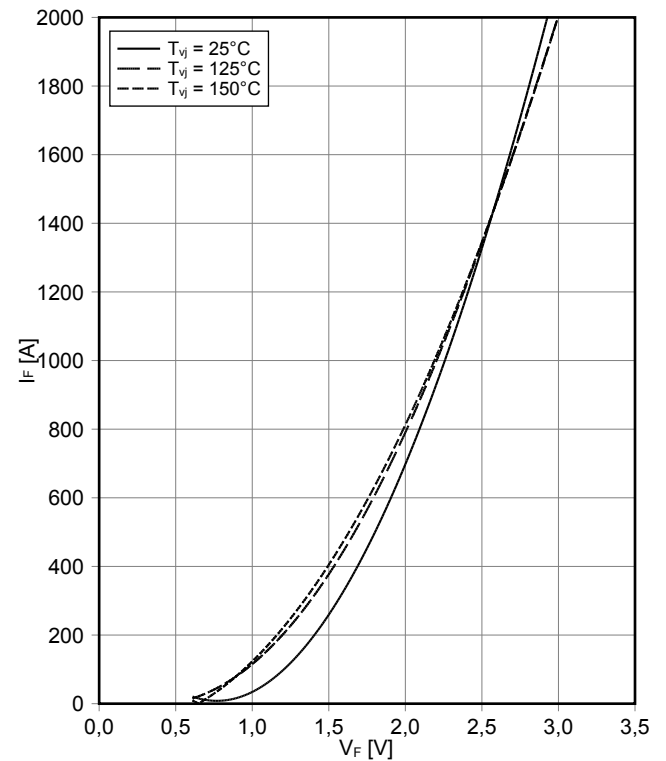

スイッチング損失 Diode、インバータ (Typical)
switching losses Diode, Inverter (typical)

$E_{rec} = f(I_F)$
 $R_{Gon} = 0.75 \Omega, V_{CE} = 1800 V$

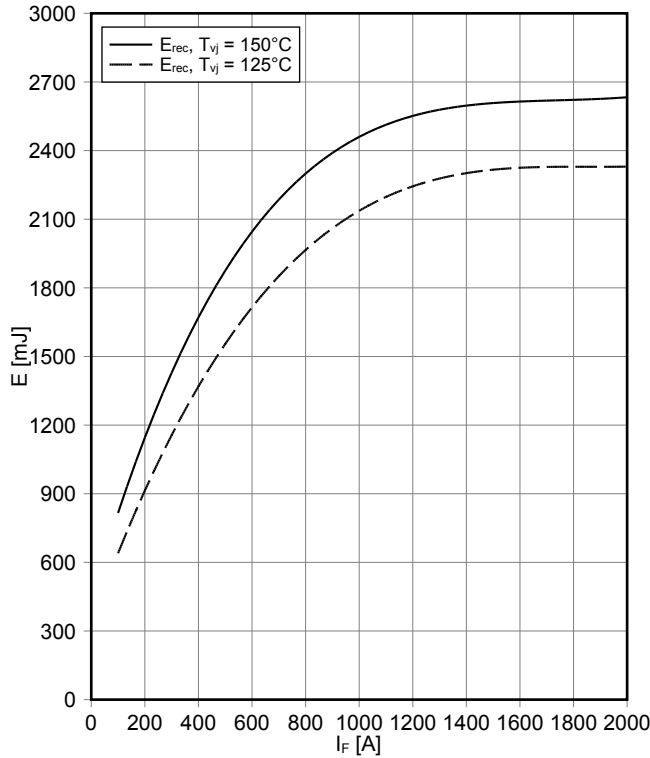

スイッチング損失 Diode、インバータ (Typical)
switching losses Diode, Inverter (typical)

$E_{rec} = f(R_G)$
 $I_F = 1000 A, V_{CE} = 1800 V$

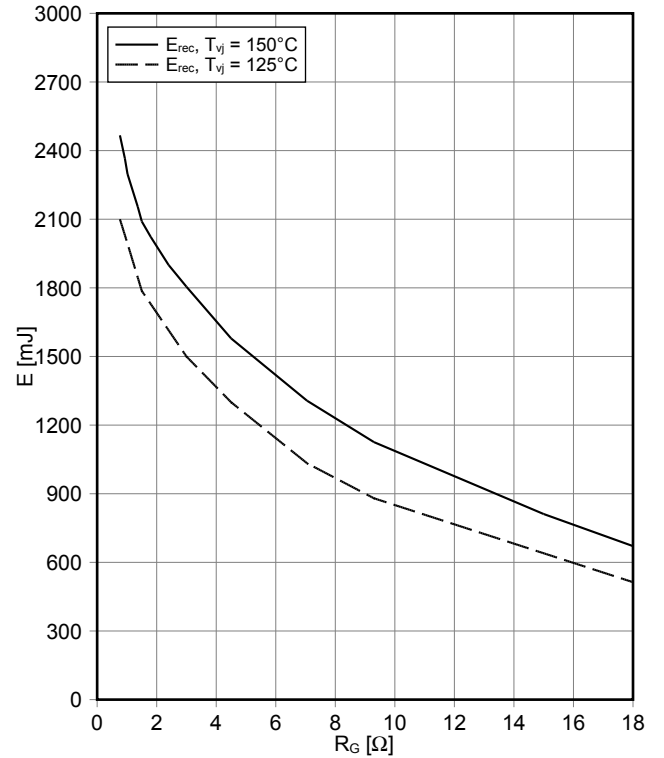

過渡熱インピーダンス Diode、インバータ
transient thermal impedance Diode, Inverter

$Z_{thJC} = f(t)$

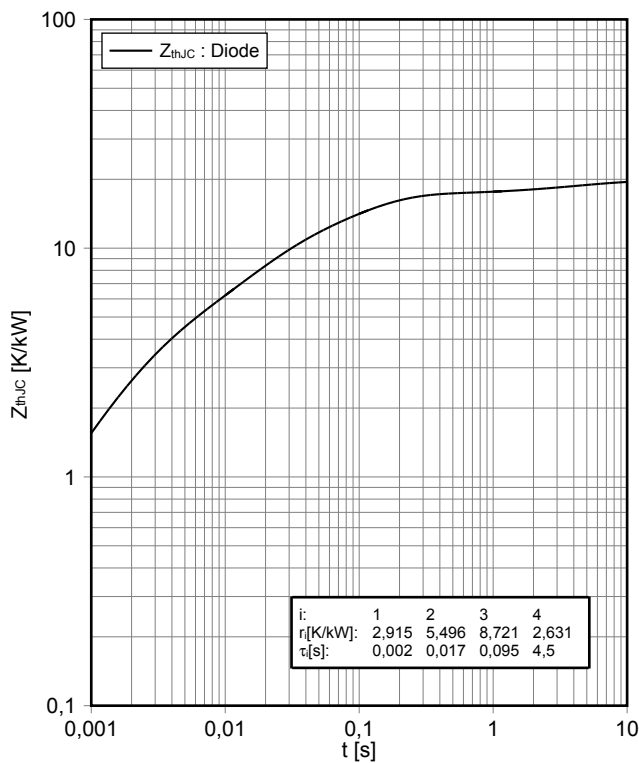

安全動作領域 Diode、インバータ (SOA)
safe operation area Diode, Inverter (SOA)

$I_R = f(V_R)$
 $T_{vj} = 150^\circ C$

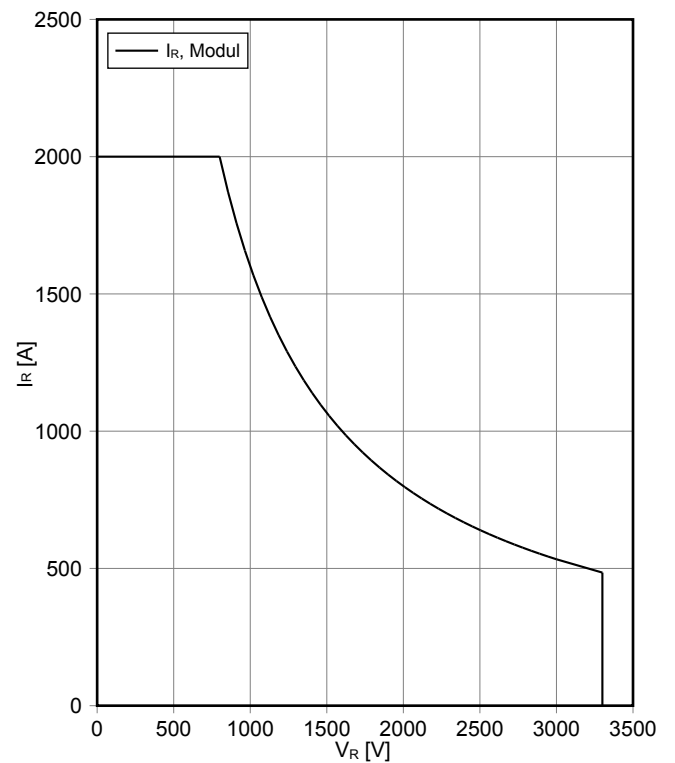

順電圧特性 Diode、ブレーキチョッパー (typical)
forward characteristic of Diode, Brake-Chopper (typical)
 $I_F = f(V_F)$

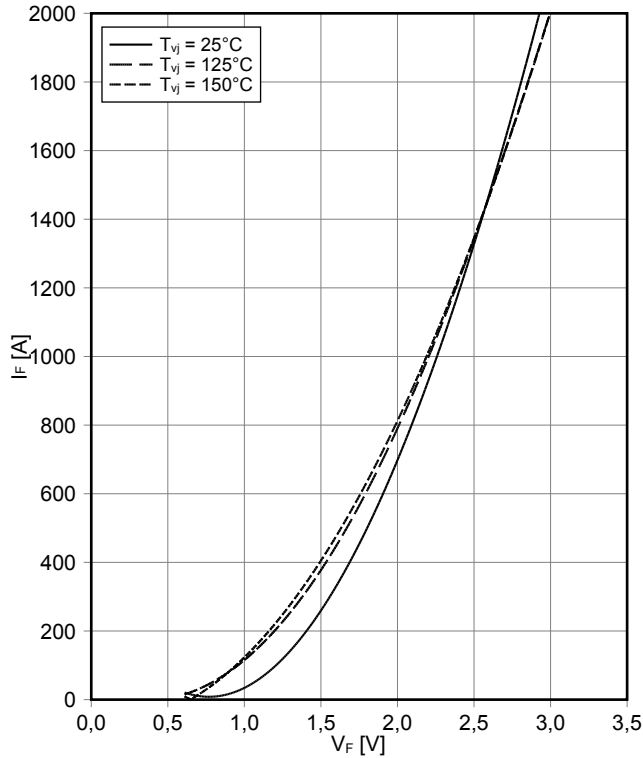

スイッチング損失 Diode、ブレーキチョッパー (Typical)
switching losses Diode, Brake-Chopper (typical)
 $E_{rec} = f(I_F)$
 $R_{Gon} = 0.75 \Omega, V_{CE} = 1800 \text{ V}$

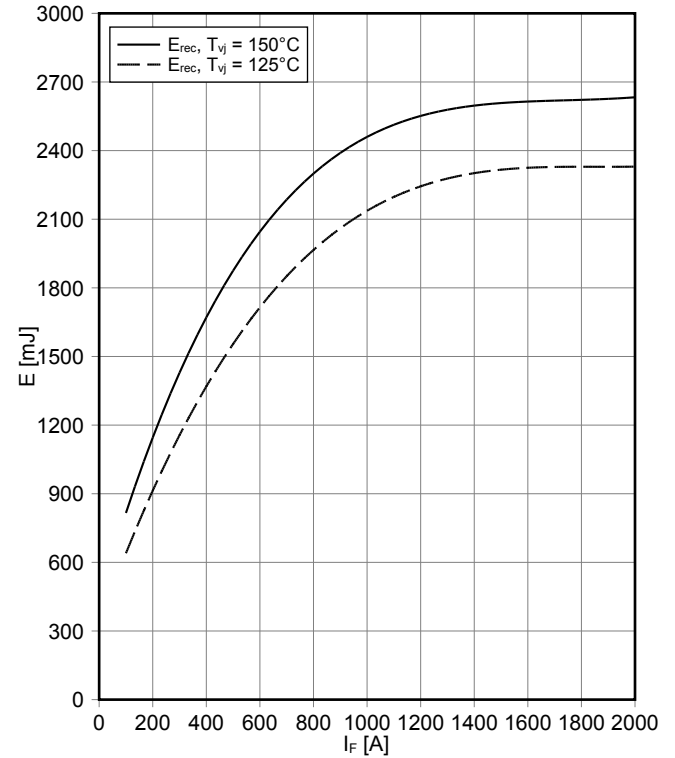

スイッチング損失 Diode、ブレーキチョッパー (Typical)
switching losses Diode, Brake-Chopper (typical)
 $E_{rec} = f(R_G)$
 $I_F = 1000 \text{ A}, V_{CE} = 1800 \text{ V}$

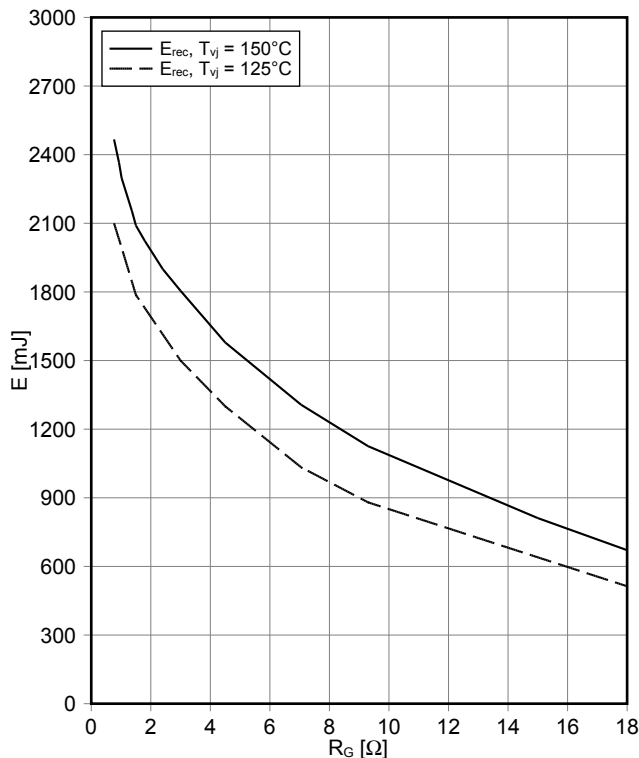

過渡熱インピーダンス Diode、ブレーキチョッパー
transient thermal impedance Diode, Brake-Chopper
 $Z_{thJC} = f(t)$

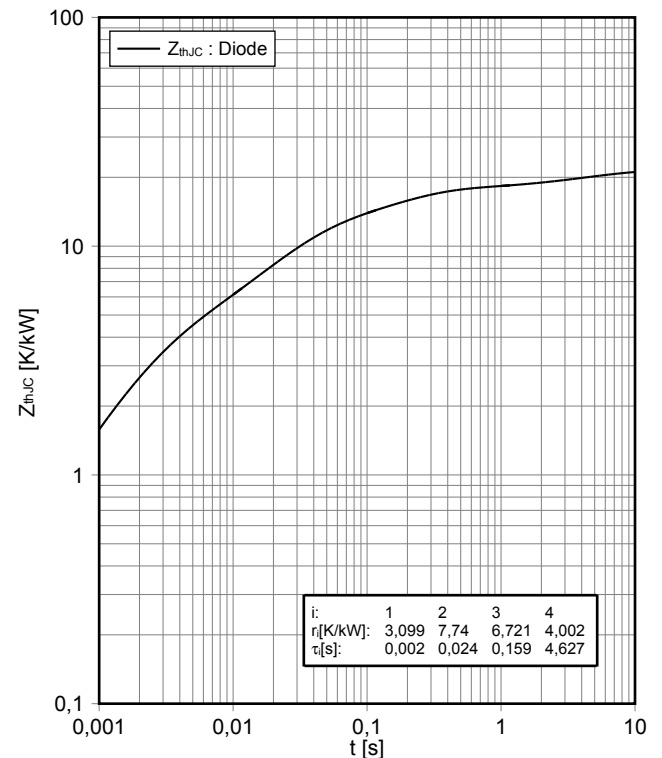

安全動作領域 Diode、ブレーキチョッパー (SOA)
safe operation area Diode, Brake-Chopper (SOA)

$I_R = f(V_R)$
 $T_{vj} = 150^\circ\text{C}$

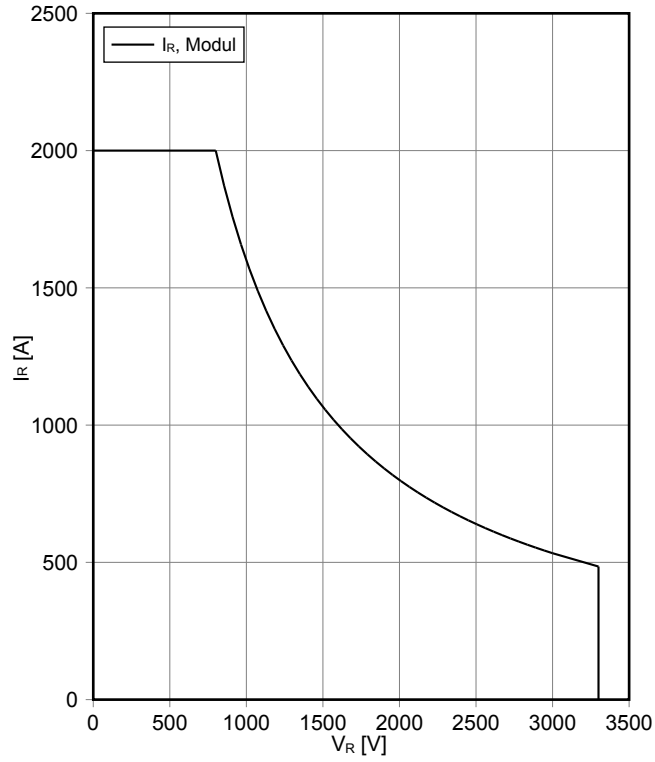

回路図 / Circuit diagram

FD...-K

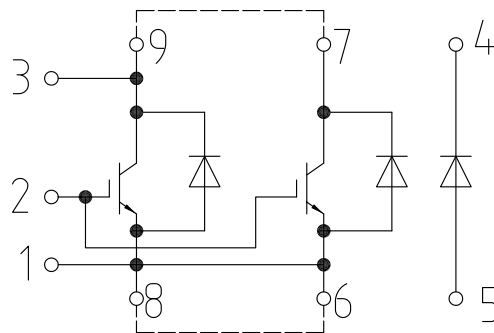

パッケージ概要 / Package outlines

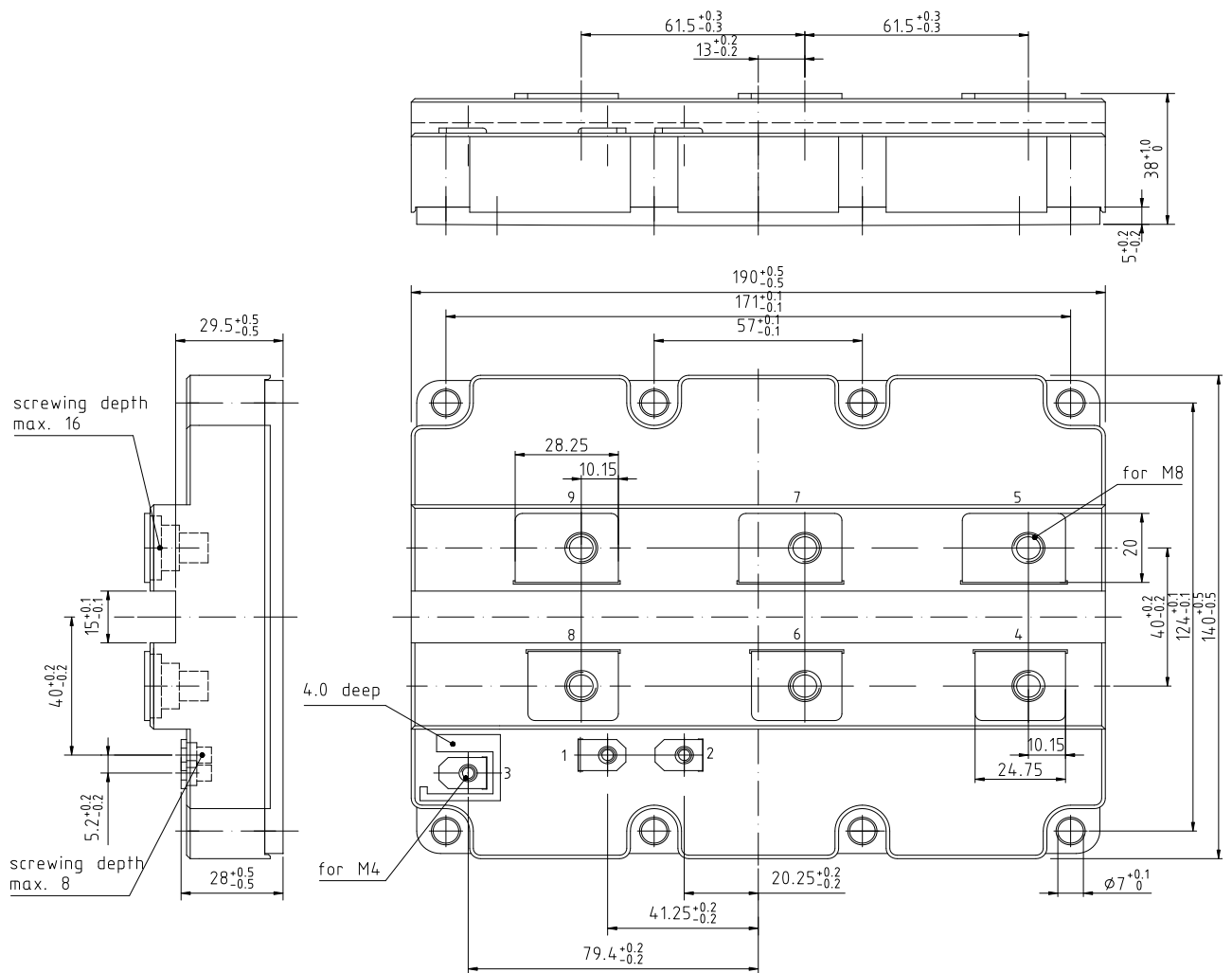

Trademarks

All referenced product or service names and trademarks are the property of their respective owners.

Edition 2019-07-24

Published by
Infineon Technologies AG
81726 München, Germany

© 2019 Infineon Technologies AG.
All Rights Reserved.

Do you have a question about this document?
Email: erratum@infineon.com

重要事項

本文書に記載された情報は、いかなる場合も、条件または特性の保証とみなされるものではありません（「品質の保証」）。本文に記載された一切の事例、手引き、もしくは一般的な価値、および / または本製品の用途に関する一切の情報に関し、インフィニオンテクノロジーズ（以下、「インフィニオン」）はここに、第三者の知的所有権の不侵害の保証を含むがこれに限らず、あらゆる種類の一切の保証および責任を否定いたします。

さらに、本文書に記載された一切の情報は、お客様の用途におけるお客様の製品およびインフィニオン製品の一切の使用に関し、本文書に記載された義務ならびに一切の関連する法的要件、規範、および基準をお客様が遵守することを条件としています。

本文書に含まれるデータは、技術的訓練を受けた従業員のみを対象としています。本製品の対象用途への適合性、およびこれら用途に関連して本文書に記載された製品情報の完全性についての評価は、お客様の技術部門の責任にて実施してください。

本製品、技術、納品条件、および価格についての詳しい情報は、インフィニオンの最寄りの営業所までお問い合わせください（www.infineon.com）。

警告事項

技術的要件に伴い、製品には危険物質が含まれる可能性があります。当該種別の詳細については、インフィニオンの最寄りの営業所までお問い合わせください。

インフィニオンの正式代表者が署名した書面を通じ、インフィニオンによる明示の承認が存在する場合を除き、インフィニオンの製品は、当該製品の障害またはその使用に関する一切の結果が、合理的に人的傷害を招く恐れのある一切の用途に使用することはできないこと予めご了承ください。

IMPORTANT NOTICE

The information given in this document shall in no event be regarded as a guarantee of conditions or characteristics ("Beschaffenheitsgarantie"). With respect to any examples, hints or any typical values stated herein and/or any information regarding the application of the product, Infineon Technologies hereby disclaims any and all warranties and liabilities of any kind, including without limitation warranties of non-infringement of intellectual property rights of any third party.

In addition, any information given in this document is subject to customer's compliance with its obligations stated in this document and any applicable legal requirements, norms and standards concerning customer's products and any use of the product of Infineon Technologies in customer's applications.

The data contained in this document is exclusively intended for technically trained staff. It is the responsibility of customer's technical departments to evaluate the suitability of the product for the intended application and the completeness of the product information given in this document with respect to such application.

For further information on the product, technology, delivery terms and conditions and prices please contact your nearest Infineon Technologies office (www.infineon.com).

WARNINGS

Due to technical requirements products may contain dangerous substances. For information on the types in question please contact your nearest Infineon Technologies office.

Except as otherwise explicitly approved by Infineon Technologies in a written document signed by authorized representatives of Infineon Technologies, Infineon Technologies' products may not be used in any applications where a failure of the product or any consequences of the use thereof can reasonably be expected to result in personal injury.