

IHM-B モジュール 高速トレンチ/フィールドストップ IGBT3 and エミッターコントロール3 diode内蔵
IHM-B module with fast Trench/Fieldstop IGBT3 and Emitter Controlled 3 diode

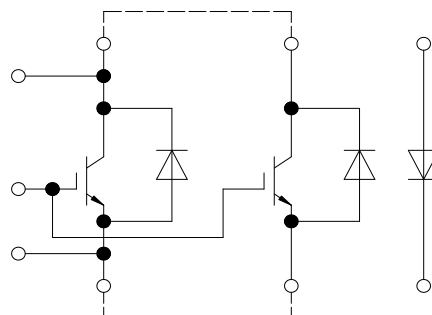

$V_{CES} = 3300V$
 $I_{C\ nom} = 1000A / I_{CRM} = 2000A$

一般応用

- チョッパアプリケーション
- 中圧コンバータ
- モーター駆動
- 電鉄駆動
- UPSシステム
- 風力タービン

Typical Applications

- Chopper Applications
- Medium Voltage Converters
- Motor Drives
- Traction Drives
- UPS Systems
- Wind Turbines

電気的特性

- 高いDC電圧での安定性
- 高い短絡電流耐量、自己抑制型短絡電流
- 低スイッチング損失
- 低 V_{CESat} 飽和電圧
- $T_{vj\ op} = 150^{\circ}C$
- 正温度特性を持った V_{CESat} 飽和電圧

Electrical Features

- High DC Stability
- High Short Circuit Capability, Self Limiting Short Circuit Current
- Low Switching Losses
- Low V_{CESat}
- $T_{vj\ op} = 150^{\circ}C$
- V_{CESat} with positive Temperature Coefficient

機械的特性

- サーマルサイクル耐量を増加するAlSiCベースプレート
- CTI(比較トラッキング指数) >600のモジュールパッケージ
- IHM Bハウジング
- 絶縁されたベースプレート

Mechanical Features

- AlSiC Base Plate for increased Thermal Cycling Capability
- Package with CTI > 600
- IHM B Housing
- Isolated Base Plate

Module Label Code

Barcode Code 128



DMX - Code



Content of the Code

Digit

Module Serial Number	1 - 5
Module Material Number	6 - 11
Production Order Number	12 - 19
Datecode (Production Year)	20 - 21
Datecode (Production Week)	22 - 23

prepared by: SB	date of publication: 2013-12-11
approved by: DTS	revision: 3.1



IGBT-ブレーキチョッパー / IGBT, Brake-Chopper
最大定格 / Maximum Rated Values

コレクタ・エミッタ間電圧 Collector-emitter voltage	$T_{vj} = -40^{\circ}\text{C}$ $T_{vj} = 150^{\circ}\text{C}$	V_{CES}	3300 3300	V
連続DCコレクタ電流 Continuous DC collector current	$T_C = 95^{\circ}\text{C}, T_{vj\max} = 150^{\circ}\text{C}$	$I_{C\text{nom}}$	1000	A
繰り返しピークコレクタ電流 Repetitive peak collector current	$t_P = 1\text{ms}$	I_{CRM}	2000	A
トータル損失 Total power dissipation	$T_C = 25^{\circ}\text{C}, T_{vj\max} = 150^{\circ}\text{C}$	P_{tot}	11,5	kW
ゲート・エミッタ間ピーク電圧 Gate-emitter peak voltage		V_{GES}	+/-20	V

電気的特性 / Characteristic Values

			min.	typ.	max.		
コレクタ・エミッタ間飽和電圧 Collector-emitter saturation voltage	$I_C = 1000\text{A}, V_{GE} = 15\text{V}$ $I_C = 1000\text{A}, V_{GE} = 15\text{V}$ $I_C = 1000\text{A}, V_{GE} = 15\text{V}$	$T_{vj} = 25^{\circ}\text{C}$ $T_{vj} = 125^{\circ}\text{C}$ $T_{vj} = 150^{\circ}\text{C}$	$V_{CE\text{sat}}$	2,55 3,00 3,15	3,10 3,45	V V V	
ゲート・エミッタ間しきい値電圧 Gate threshold voltage	$I_C = 48,0\text{mA}, V_{CE} = V_{GE}, T_{vj} = 25^{\circ}\text{C}$		V_{GEth}	5,2	5,8	6,4	V
ゲート電荷量 Gate charge	$V_{GE} = -15\text{V} \dots +15\text{V}, V_{CE} = 1800\text{V}$		Q_G	28,0			μC
内蔵ゲート抵抗 Internal gate resistor	$T_{vj} = 25^{\circ}\text{C}$		R_{Gint}	0,63			Ω
入力容量 Input capacitance	$f = 1\text{MHz}, T_{vj} = 25^{\circ}\text{C}, V_{CE} = 25\text{V}, V_{GE} = 0\text{V}$		C_{ies}	190			nF
帰還容量 Reverse transfer capacitance	$f = 1\text{MHz}, T_{vj} = 25^{\circ}\text{C}, V_{CE} = 25\text{V}, V_{GE} = 0\text{V}$		C_{res}	4,00			nF
コレクタ・エミッタ間遮断電流 Collector-emitter cut-off current	$V_{CE} = 3300\text{V}, V_{GE} = 0\text{V}, T_{vj} = 25^{\circ}\text{C}$		I_{CES}			5,0	mA
ゲート・エミッタ間漏れ電流 Gate-emitter leakage current	$V_{CE} = 0\text{V}, V_{GE} = 20\text{V}, T_{vj} = 25^{\circ}\text{C}$		I_{GES}			400	nA
ターンオン遅れ時間 (誘導負荷) Turn-on delay time, inductive load	$I_C = 1000\text{A}, V_{CE} = 1800\text{V}$ $V_{GE} = \pm 15\text{V}$ $R_{Gon} = 1,5\Omega, C_{GE} = 220\text{nF}$	$T_{vj} = 25^{\circ}\text{C}$ $T_{vj} = 125^{\circ}\text{C}$ $T_{vj} = 150^{\circ}\text{C}$	t_{don}	0,60 0,60 0,60			μs μs μs
ターンオン上昇時間 (誘導負荷) Rise time, inductive load	$I_C = 1000\text{A}, V_{CE} = 1800\text{V}$ $V_{GE} = \pm 15\text{V}$ $R_{Gon} = 1,5\Omega, C_{GE} = 220\text{nF}$	$T_{vj} = 25^{\circ}\text{C}$ $T_{vj} = 125^{\circ}\text{C}$ $T_{vj} = 150^{\circ}\text{C}$	t_r	0,55 0,55 0,55			μs μs μs
ターンオフ遅れ時間 (誘導負荷) Turn-off delay time, inductive load	$I_C = 1000\text{A}, V_{CE} = 1800\text{V}$ $V_{GE} = \pm 15\text{V}$ $R_{Goff} = 2,3\Omega, C_{GE} = 220\text{nF}$	$T_{vj} = 25^{\circ}\text{C}$ $T_{vj} = 125^{\circ}\text{C}$ $T_{vj} = 150^{\circ}\text{C}$	t_{doff}	3,00 3,20 3,20			μs μs μs
ターンオフ下降時間 (誘導負荷) Fall time, inductive load	$I_C = 1000\text{A}, V_{CE} = 1800\text{V}$ $V_{GE} = \pm 15\text{V}$ $R_{Goff} = 2,3\Omega, C_{GE} = 220\text{nF}$	$T_{vj} = 25^{\circ}\text{C}$ $T_{vj} = 125^{\circ}\text{C}$ $T_{vj} = 150^{\circ}\text{C}$	t_f	0,30 0,35 0,35			μs μs μs
ターンオンスイッチング損失 Turn-on energy loss per pulse	$I_C = 1000\text{A}, V_{CE} = 1800\text{V}, L_S = 85\text{nH}$ $V_{GE} = \pm 15\text{V}, di/dt = 3000\text{A}/\mu\text{s} (T_{vj} = 150^{\circ}\text{C})$ $R_{Gon} = 0,71\Omega, C_{GE} = 220\text{nF}$	$T_{vj} = 25^{\circ}\text{C}$ $T_{vj} = 125^{\circ}\text{C}$ $T_{vj} = 150^{\circ}\text{C}$	E_{on}	1250 1700 1950			mJ mJ mJ
ターンオフスイッチング損失 Turn-off energy loss per pulse	$I_C = 1000\text{A}, V_{CE} = 1800\text{V}, L_S = 85\text{nH}$ $V_{GE} = \pm 15\text{V}, du/dt = 2100\text{V}/\mu\text{s} (T_{vj} = 150^{\circ}\text{C})$ $R_{Goff} = 2,3\Omega, C_{GE} = 220\text{nF}$	$T_{vj} = 25^{\circ}\text{C}$ $T_{vj} = 125^{\circ}\text{C}$ $T_{vj} = 150^{\circ}\text{C}$	E_{off}	1050 1400 1550			mJ mJ mJ
短絡電流 SC data	$V_{GE} \leq 15\text{V}, V_{CC} = 2500\text{V}$ $V_{CEmax} = V_{CES} - L_{SCE} \cdot di/dt$ $t_P \leq 10\mu\text{s}, T_{vj} = 150^{\circ}\text{C}$		I_{SC}	4300			A
ジャンクション・ケース間熱抵抗 Thermal resistance, junction to case	IGBT部 (1素子当り) / per IGBT		R_{thJC}			11,0	K/kW
ケース・ヒートシンク間熱抵抗 Thermal resistance, case to heatsink	IGBT部 (1素子当り) / per IGBT $\lambda_{\text{Paste}} = 1\text{W}/(\text{m}\cdot\text{K})$ / $\lambda_{\text{grease}} = 1\text{W}/(\text{m}\cdot\text{K})$		R_{thCH}			14,5	K/kW
動作温度 Temperature under switching conditions			$T_{vj\text{op}}$	-40		150	$^{\circ}\text{C}$

prepared by: SB	date of publication: 2013-12-11
approved by: DTS	revision: 3.1



Diode、ブレーキチョッパー / Diode, Brake-Chopper
最大定格 / Maximum Rated Values

ピーク繰返し逆電圧 Repetitive peak reverse voltage	$T_{vj} = -40^{\circ}\text{C}$ $T_{vj} = 150^{\circ}\text{C}$	V_{RRM}	3300 3300	V
連続DC電流 Continuous DC forward current		I_F	1000	A
ピーク繰返し順電流 Repetitive peak forward current	$t_P = 1 \text{ ms}$	I_{FRM}	2000	A
電流二乗時間積 I^2t - value	$V_R = 0 \text{ V}, t_P = 10 \text{ ms}, T_{vj} = 125^{\circ}\text{C}$ $V_R = 0 \text{ V}, t_P = 10 \text{ ms}, T_{vj} = 150^{\circ}\text{C}$	I^2t	260 245	kA^2s kA^2s
最大損失 Maximum power dissipation	$T_{vj} = 125^{\circ}\text{C}$	P_{RQM}	1600	kW
最小ターンオン時間 Minimum turn-on time		$t_{on \text{ min}}$	10,0	μs

電気的特性 / Characteristic Values

			min.	typ.	max.	
順電圧 Forward voltage	$I_F = 1000 \text{ A}, V_{GE} = 0 \text{ V}$ $I_F = 1000 \text{ A}, V_{GE} = 0 \text{ V}$ $I_F = 1000 \text{ A}, V_{GE} = 0 \text{ V}$	$T_{vj} = 25^{\circ}\text{C}$ $T_{vj} = 125^{\circ}\text{C}$ $T_{vj} = 150^{\circ}\text{C}$	V_F	3,10 2,75 2,65	3,85 3,25	V V V
ピーク逆回復電流 Peak reverse recovery current	$I_F = 1000 \text{ A}, -di_F/dt = 3000 \text{ A}/\mu\text{s} (T_{vj}=150^{\circ}\text{C})$ $V_R = 1800 \text{ V}$ $V_{GE} = -15 \text{ V}$	$T_{vj} = 25^{\circ}\text{C}$ $T_{vj} = 125^{\circ}\text{C}$ $T_{vj} = 150^{\circ}\text{C}$	I_{RM}	1000 1200 1250		A A A
逆回復電荷量 Recovered charge	$I_F = 1000 \text{ A}, -di_F/dt = 3000 \text{ A}/\mu\text{s} (T_{vj}=150^{\circ}\text{C})$ $V_R = 1800 \text{ V}$ $V_{GE} = -15 \text{ V}$	$T_{vj} = 25^{\circ}\text{C}$ $T_{vj} = 125^{\circ}\text{C}$ $T_{vj} = 150^{\circ}\text{C}$	Q_r	450 900 1050		μC μC μC
逆回復損失 Reverse recovery energy	$I_F = 1000 \text{ A}, -di_F/dt = 3000 \text{ A}/\mu\text{s} (T_{vj}=150^{\circ}\text{C})$ $V_R = 1800 \text{ V}$ $V_{GE} = -15 \text{ V}$	$T_{vj} = 25^{\circ}\text{C}$ $T_{vj} = 125^{\circ}\text{C}$ $T_{vj} = 150^{\circ}\text{C}$	E_{rec}	450 1100 1300		mJ mJ mJ
ジャンクション・ケース間熱抵抗 Thermal resistance, junction to case	/Diode (1 素子当り) / per diode		R_{thJC}		20,0	K/kW
ケース・ヒートシンク間熱抵抗 Thermal resistance, case to heatsink	/Diode (1 素子当り) / per diode $\lambda_{\text{Paste}} = 1 \text{ W}/(\text{m}\cdot\text{K})$ / $\lambda_{\text{grease}} = 1 \text{ W}/(\text{m}\cdot\text{K})$		R_{thCH}	16,5		K/kW
動作温度 Temperature under switching conditions			$T_{vj \text{ op}}$	-40	150	$^{\circ}\text{C}$

prepared by: SB	date of publication: 2013-12-11
approved by: DTS	revision: 3.1



Diode、リバーズ / Diode, Reverse
最大定格 / Maximum Rated Values

ピーク繰返し逆電圧 Repetitive peak reverse voltage	$T_{vj} = -40^{\circ}\text{C}$ $T_{vj} = 150^{\circ}\text{C}$	V_{RRM}	3300 3300	V
連続DC電流 Continuous DC forward current		I_F	1000	A
ピーク繰返し順電流 Repetitive peak forward current	$t_P = 1 \text{ ms}$	I_{FRM}	2000	A
電流二乗時間積 I^2t - value	$V_R = 0 \text{ V}, t_P = 10 \text{ ms}, T_{vj} = 125^{\circ}\text{C}$ $V_R = 0 \text{ V}, t_P = 10 \text{ ms}, T_{vj} = 150^{\circ}\text{C}$	I^2t	260 245	kA^2s kA^2s
最大損失 Maximum power dissipation	$T_{vj} = 125^{\circ}\text{C}$	P_{RQM}	1600	kW
最小ターンオン時間 Minimum turn-on time		$t_{on \text{ min}}$	10,0	μs

電気的特性 / Characteristic Values

			min.	typ.	max.	
順電圧 Forward voltage	$I_F = 1000 \text{ A}, V_{GE} = 0 \text{ V}$ $I_F = 1000 \text{ A}, V_{GE} = 0 \text{ V}$ $I_F = 1000 \text{ A}, V_{GE} = 0 \text{ V}$	$T_{vj} = 25^{\circ}\text{C}$ $T_{vj} = 125^{\circ}\text{C}$ $T_{vj} = 150^{\circ}\text{C}$	V_F	3,10 2,75 2,65	3,85 3,25	V V V
ピーク逆回復電流 Peak reverse recovery current	$I_F = 1000 \text{ A}, -di_F/dt = 3000 \text{ A}/\mu\text{s} (T_{vj}=150^{\circ}\text{C})$ $V_R = 1800 \text{ V}$	$T_{vj} = 25^{\circ}\text{C}$ $T_{vj} = 125^{\circ}\text{C}$ $T_{vj} = 150^{\circ}\text{C}$	I_{RM}	1000 1200 1250		A A A
逆回復電荷量 Recovered charge	$I_F = 1000 \text{ A}, -di_F/dt = 3000 \text{ A}/\mu\text{s} (T_{vj}=150^{\circ}\text{C})$ $V_R = 1800 \text{ V}$	$T_{vj} = 25^{\circ}\text{C}$ $T_{vj} = 125^{\circ}\text{C}$ $T_{vj} = 150^{\circ}\text{C}$	Q_r	450 900 1050		μC μC μC
逆回復損失 Reverse recovery energy	$I_F = 1000 \text{ A}, -di_F/dt = 3000 \text{ A}/\mu\text{s} (T_{vj}=150^{\circ}\text{C})$ $V_R = 1800 \text{ V}$	$T_{vj} = 25^{\circ}\text{C}$ $T_{vj} = 125^{\circ}\text{C}$ $T_{vj} = 150^{\circ}\text{C}$	E_{rec}	450 1100 1300		mJ mJ mJ
ジャンクション・ケース間熱抵抗 Thermal resistance, junction to case	/Diode (1 素子当り) / per diode		R_{thJC}		21,5	K/kW
ケース・ヒートシンク間熱抵抗 Thermal resistance, case to heatsink	/Diode (1 素子当り) / per diode $\lambda_{\text{Paste}} = 1 \text{ W}/(\text{m}\cdot\text{K})$ / $\lambda_{\text{grease}} = 1 \text{ W}/(\text{m}\cdot\text{K})$		R_{thCH}	16,5		K/kW
動作温度 Temperature under switching conditions			$T_{vj \text{ op}}$	-40	150	$^{\circ}\text{C}$

prepared by: SB	date of publication: 2013-12-11
approved by: DTS	revision: 3.1



モジュール / Module

絶縁耐圧 Isolation test voltage	RMS, f = 50 Hz, t = 1 min.	V _{ISOL}	6,0		kV
部分放電電圧 Partial discharge extinction voltage	RMS, f = 50 Hz, Q _{PD} ≤ 10 pC (acc. to IEC 1287)	V _{ISOL}	2,6		kV
DCスタビリティ DC stability	T _{vj} = 25°C, 100 fit	V _{CE D}	2100		V
ベースプレート材質 Material of module baseplate			AISiC		
沿面距離 Creepage distance	連絡方法 - ヒートシンク / terminal to heatsink 連絡方法 - 連絡方法 / terminal to terminal		32,2		mm
空間距離 Clearance	連絡方法 - ヒートシンク / terminal to heatsink 連絡方法 - 連絡方法 / terminal to terminal		19,1		mm
相対トラッキング指数 Comperative tracking index		CTI	> 600		
			min.	typ.	max.
内部インダクタンス Stray inductance module		L _{sCE}	9,0		nH
パワーターミナル・チップ間抵抗 Module lead resistance, terminals - chip	T _C = 25°C, /スイッチ / per switch	R _{CC'+EE'} R _{AA'+CC'}	0,19 0,28		mΩ
保存温度 Storage temperature		T _{stg}	-40	150	°C
取り付けネジ締め付けトルク Mounting torque for modul mounting	取り付けネジ M6 適切なアプリケーションノートによるマウンティング Screw M6 - Mounting according to valid application note	M	4,25	-	5,75 Nm
主端子ネジ締め付けトルク Terminal connection torque	取り付けネジ M4 適切なアプリケーションノートによるマウンティング Screw M4 - Mounting according to valid application note 取り付けネジ M8 適切なアプリケーションノートによるマウンティング Screw M8 - Mounting according to valid application note	M	1,8 8,0	-	2,1 10 Nm
質量 Weight		G	1200		g

Modulinduktivität: IGBT (Zweig 1+2 parallel): 9nH; Diode (Zweig 3): 18nH
stray inductance module: IGBT (arm 1+2 parallel): 9nH; diode (arm 3): 18nH

prepared by: SB	date of publication: 2013-12-11
approved by: DTS	revision: 3.1



出力特性 IGBT-ブレーキチョッパー (Typical)
output characteristic IGBT, Brake-Chopper (typical)

$I_C = f(V_{CE})$
 $V_{GE} = 15\text{ V}$

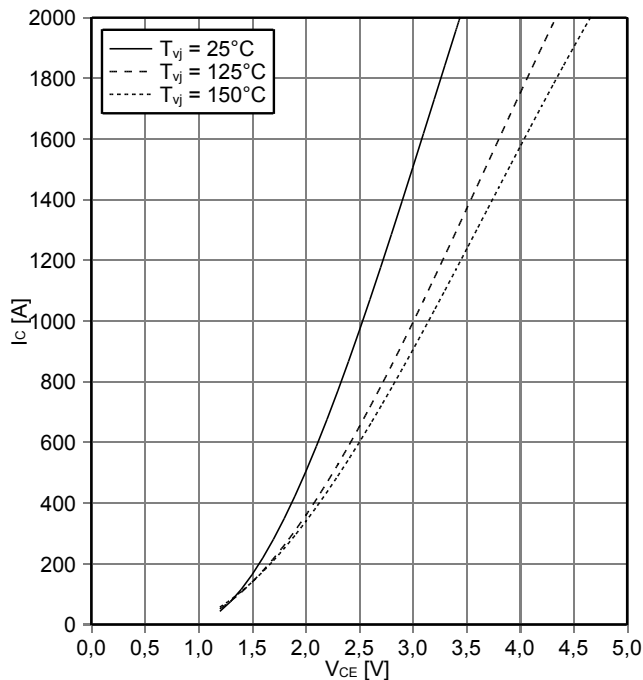

出力特性 IGBT-ブレーキチョッパー (Typical)
output characteristic IGBT, Brake-Chopper (typical)

$I_C = f(V_{CE})$
 $T_{vj} = 150^\circ\text{C}$

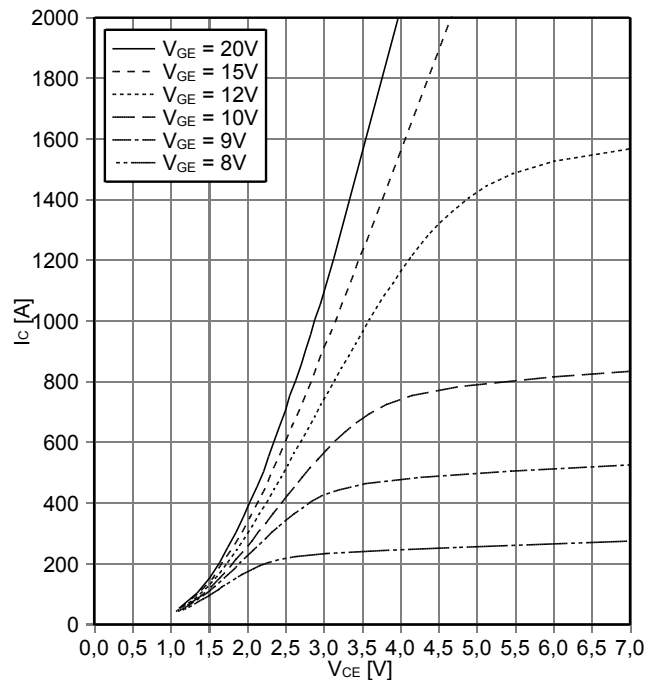

伝達特性 IGBT-ブレーキチョッパー (Typical)
transfer characteristic IGBT, Brake-Chopper (typical)

$I_C = f(V_{GE})$
 $V_{CE} = 20\text{ V}$

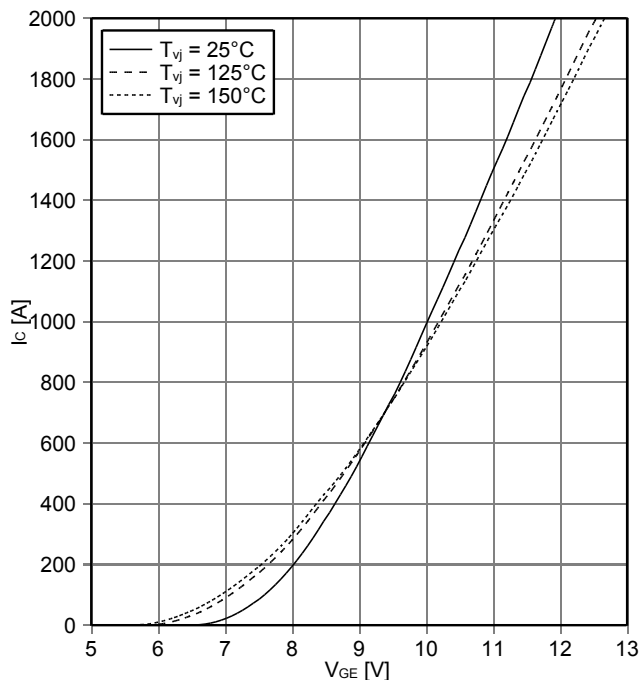

スイッチング損失 IGBT-ブレーキチョッパー (Typical)
switching losses IGBT, Brake-Chopper (typical)

$E_{on} = f(I_C)$, $E_{off} = f(I_C)$
 $V_{GE} = \pm 15\text{ V}$, $R_{Gon} = 0.71\ \Omega$, $R_{Goff} = 2.3\ \Omega$, $V_{CE} = 1800\text{ V}$, $C_{GE} = 220\text{ nF}$

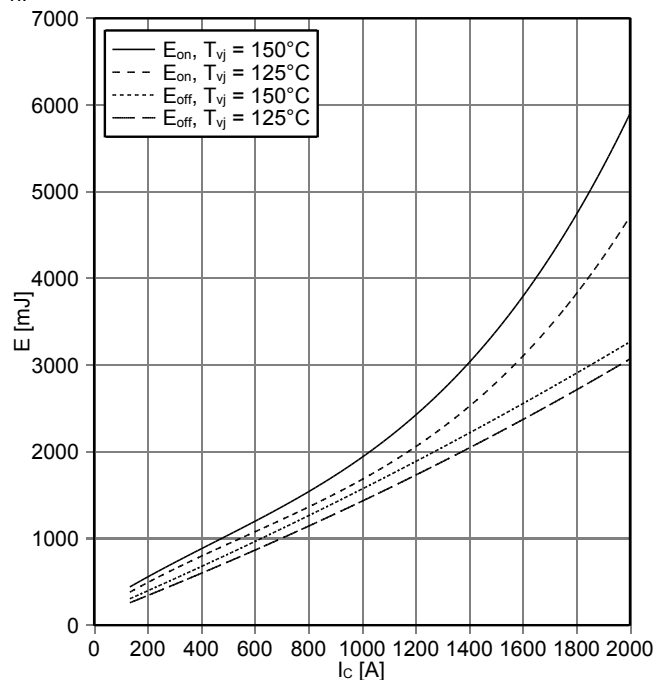

prepared by: SB	date of publication: 2013-12-11
approved by: DTS	revision: 3.1



スイッチング損失 IGBT-ブレーキチョッパー (Typical)
switching losses IGBT, Brake-Chopper (typical)

$E_{on} = f(R_G)$, $E_{off} = f(R_G)$
 $V_{GE} = \pm 15\text{ V}$, $I_C = 1000\text{ A}$, $V_{CE} = 1800\text{ V}$, $C_{GE} = 220\text{ nF}$

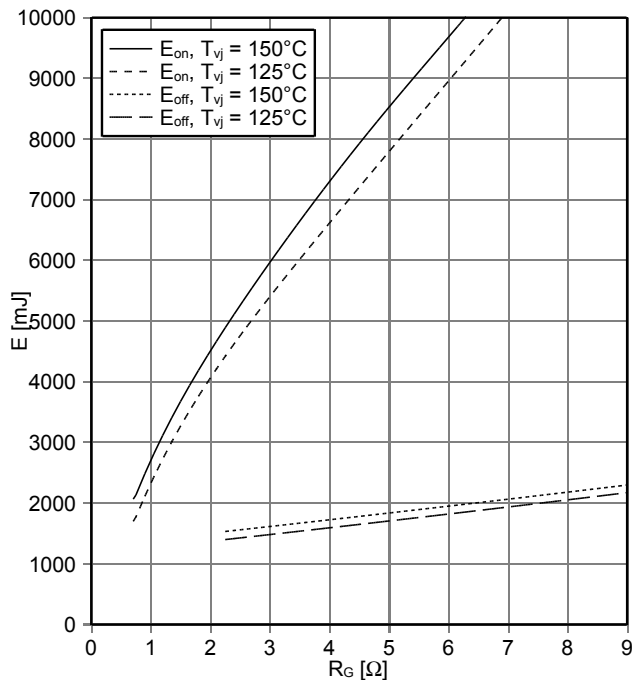

過渡熱インピーダンス IGBT-ブレーキチョッパー
transient thermal impedance IGBT, Brake-Chopper

$Z_{thJC} = f(t)$

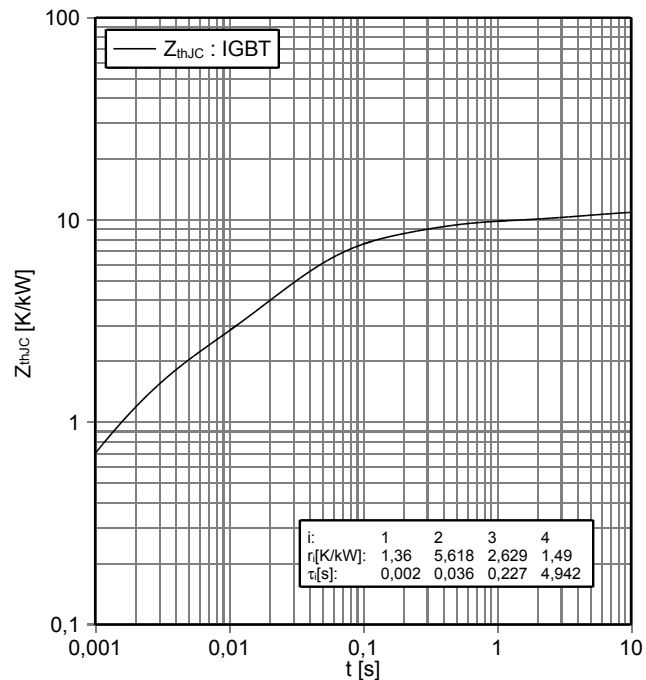

逆バイアス安全動作領域 IGBT-ブレーキチョッパー (RBSOA)
reverse bias safe operating area IGBT, Brake-Chopper (RBSOA)

$I_C = f(V_{CE})$
 $V_{GE} = \pm 15\text{ V}$, $R_{Goff} = 2.3\ \Omega$, $T_{vj} = 150^\circ\text{C}$, $C_{GE} = 220\text{ nF}$

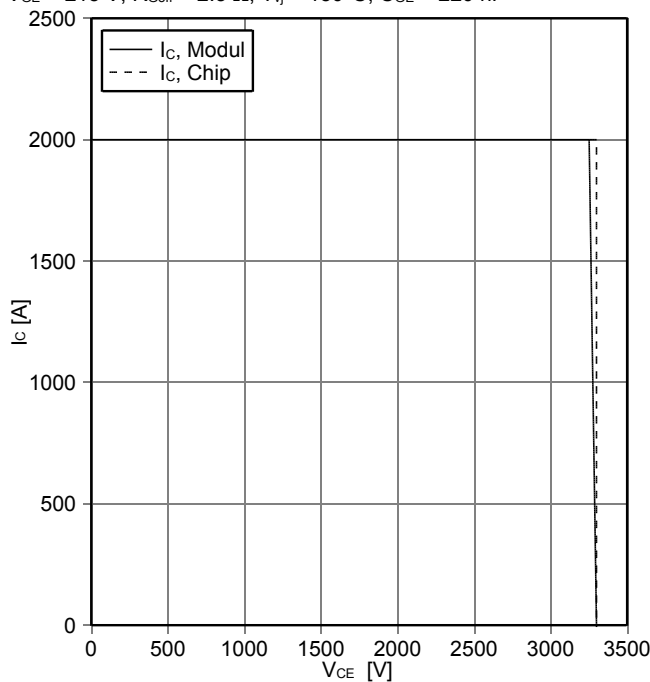

順電圧特性 Diode、ブレーキチョッパー (typical)
forward characteristic of Diode, Brake-Chopper (typical)

$I_F = f(V_F)$

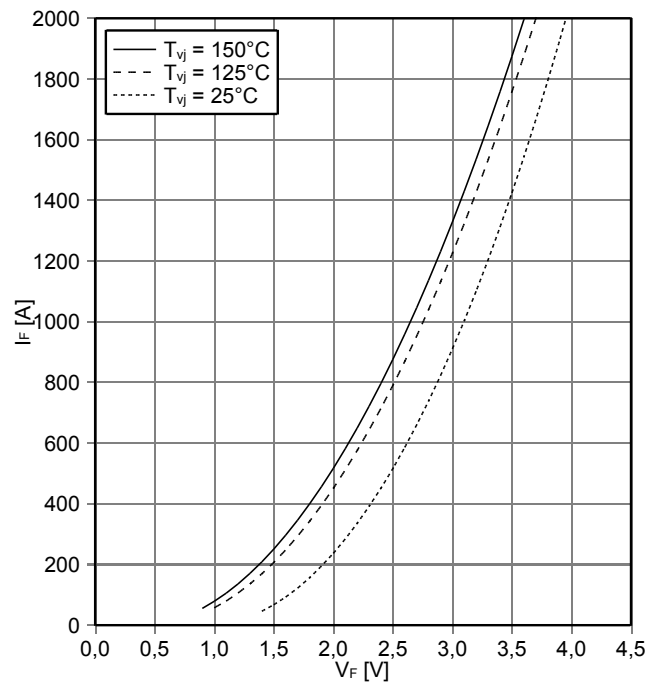

prepared by: SB	date of publication: 2013-12-11
approved by: DTS	revision: 3.1



スイッチング損失 Diode、ブレーキチョッパー (Typical)
switching losses Diode, Brake-Chopper (typical)

$E_{rec} = f(I_F)$
 $R_{Gon} = 0.71 \Omega, V_{CE} = 1800 V$

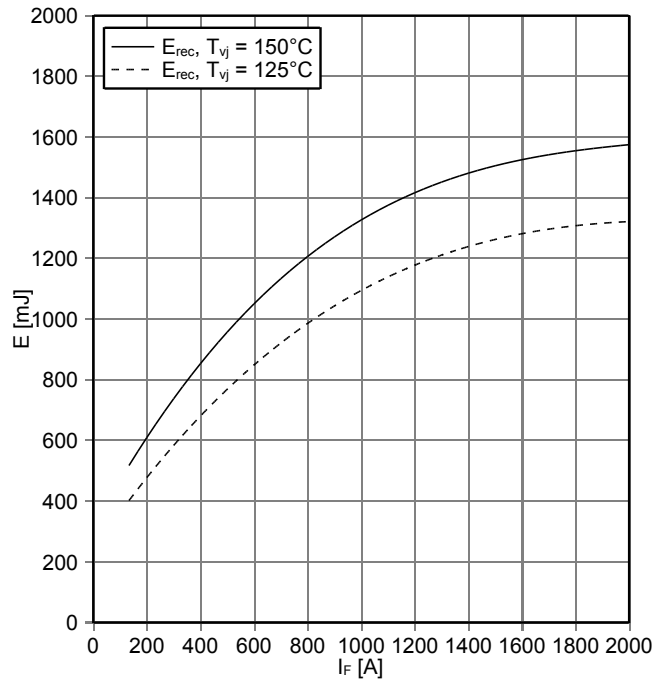

スイッチング損失 Diode、ブレーキチョッパー (Typical)
switching losses Diode, Brake-Chopper (typical)

$E_{rec} = f(R_G)$
 $I_F = 1000 A, V_{CE} = 1800 V$

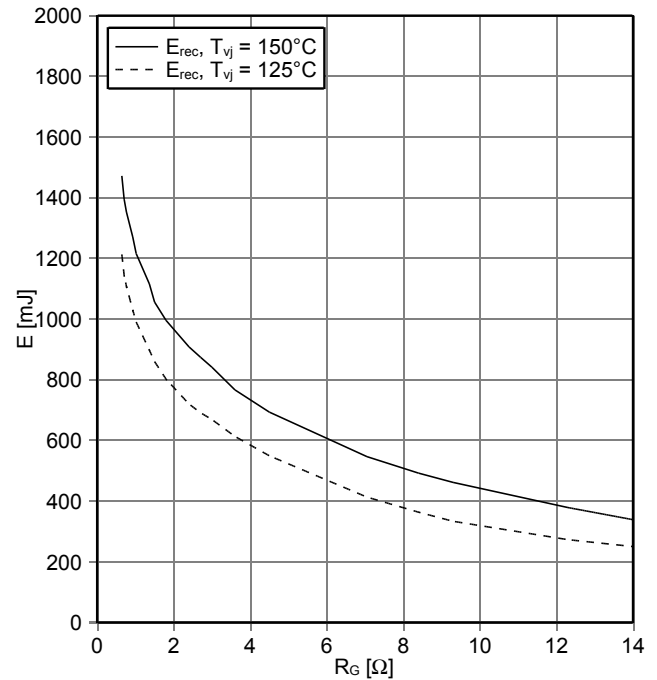

過渡熱インピーダンス Diode、ブレーキチョッパー
transient thermal impedance Diode, Brake-Chopper

$Z_{thJC} = f(t)$

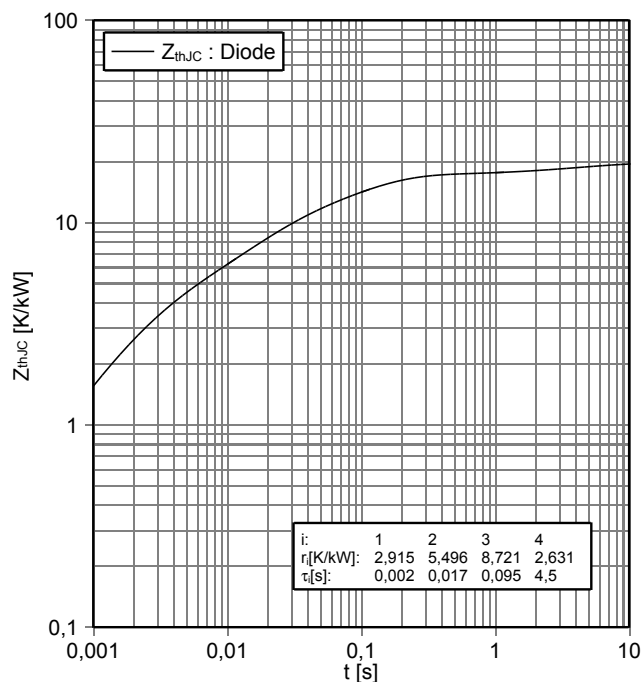

安全動作領域 Diode、ブレーキチョッパー (SOA)
safe operation area Diode, Brake-Chopper (SOA)

$I_R = f(V_R)$
 $T_{vj} = 150^\circ C$

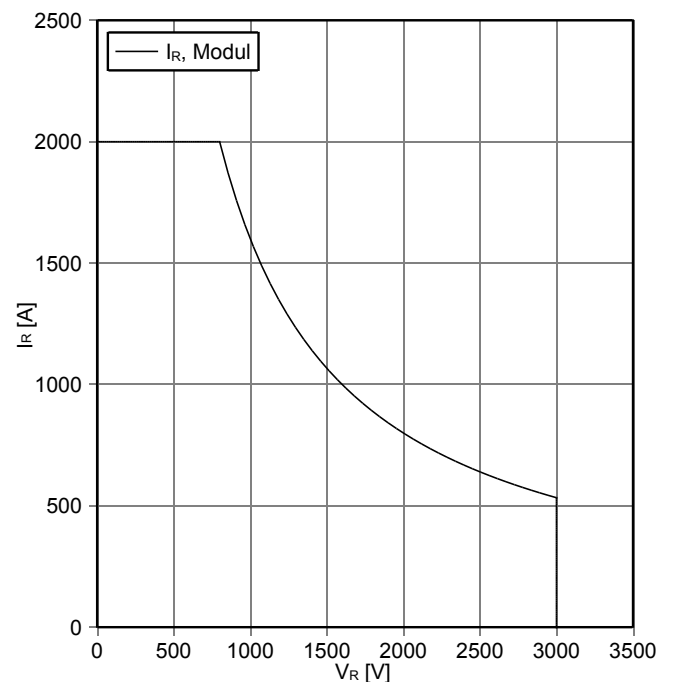

prepared by: SB	date of publication: 2013-12-11
approved by: DTS	revision: 3.1



順電圧特性 Diode、リバース (typical)
forward characteristic of Diode, Reverse (typical)
 $I_F = f(V_F)$

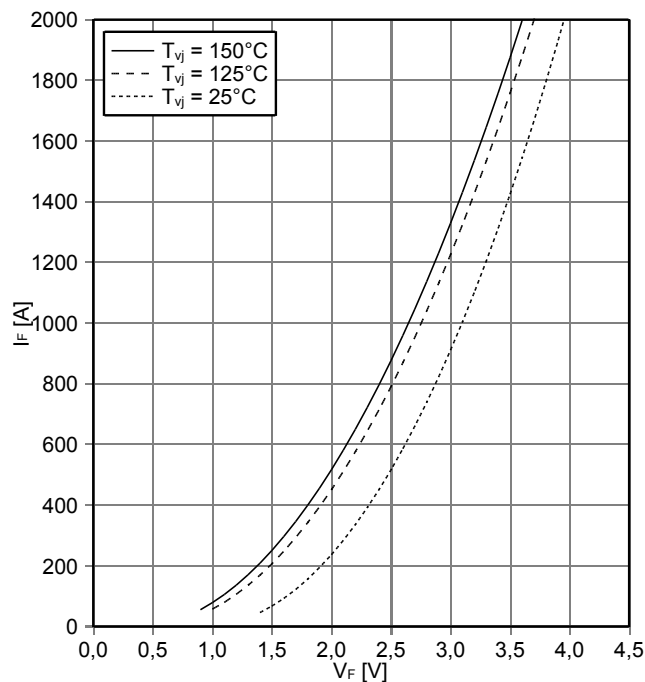

スイッチング損失 Diode、リバース (Typical)
switching losses Diode, Reverse (typical)
 $E_{rec} = f(I_F)$

$R_{Gon} = 0.71 \Omega$, $V_{CE} = 1800 V$

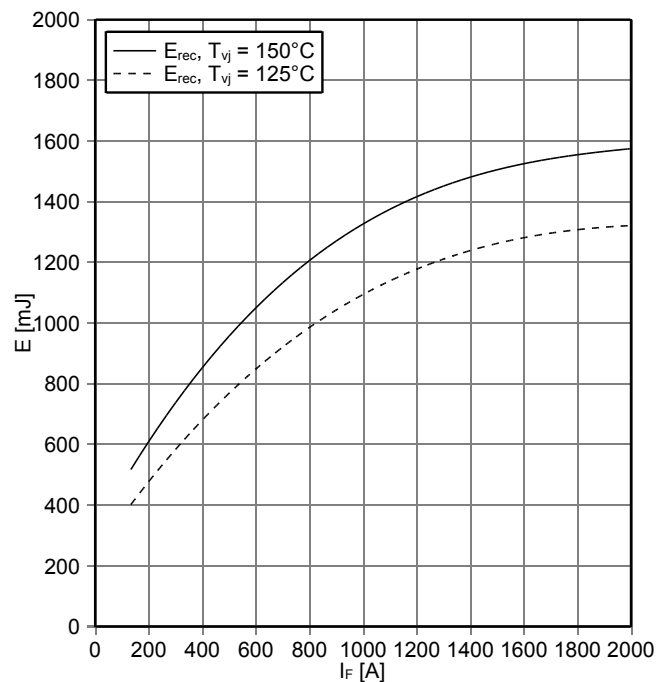

スイッチング損失 Diode、リバース (Typical)
switching losses Diode, Reverse (typical)
 $E_{rec} = f(R_G)$

$I_F = 1000 A$, $V_{CE} = 1800 V$

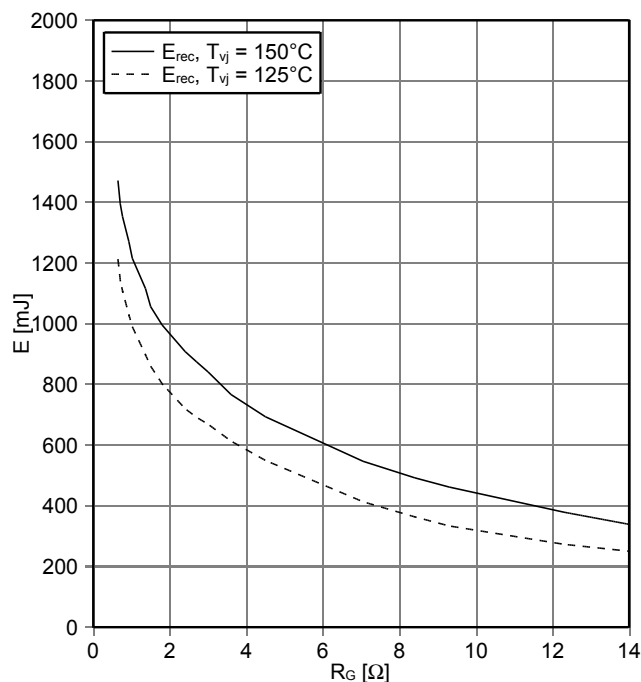

過渡熱インピーダンス Diode、リバース
transient thermal impedance Diode, Reverse
 $Z_{thJC} = f(t)$

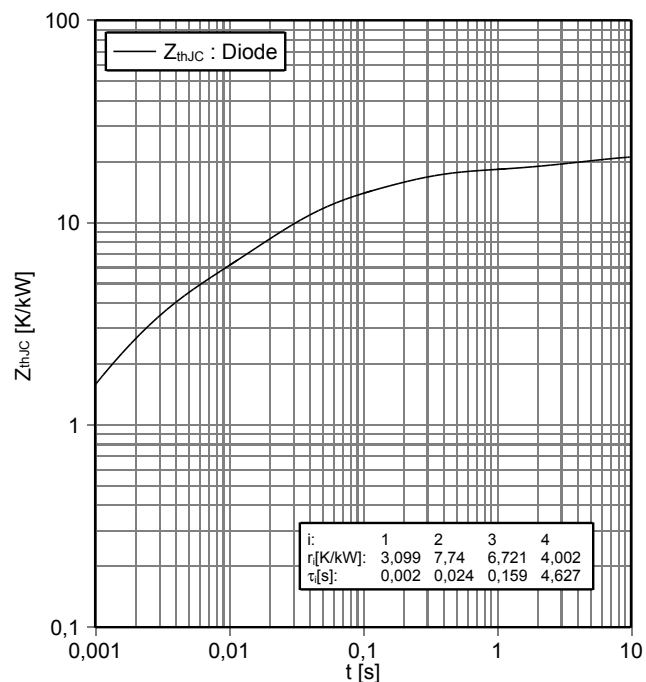

prepared by: SB	date of publication: 2013-12-11
approved by: DTS	revision: 3.1



安全動作領域 Diode、リバース (SOA)
safe operation area Diode, Reverse (SOA)

$I_R = f(V_R)$
 $T_{vj} = 150^\circ\text{C}$

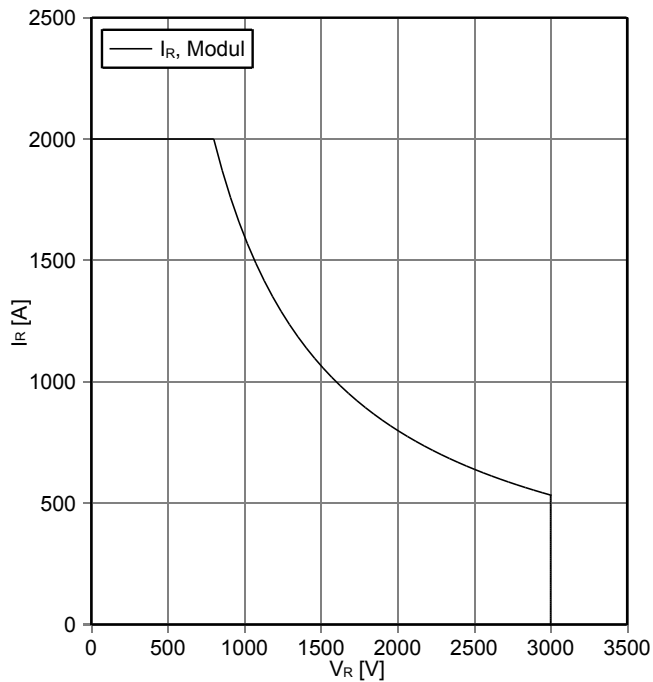

prepared by: SB	date of publication: 2013-12-11
approved by: DTS	revision: 3.1

回路図 / circuit_diagram_headline

FD...-K

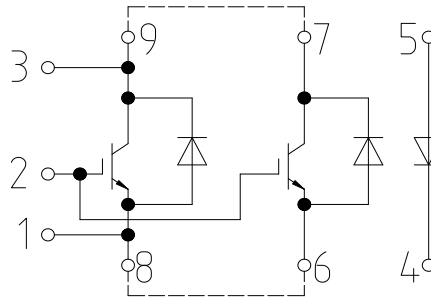

パッケージ概要 / package outlines

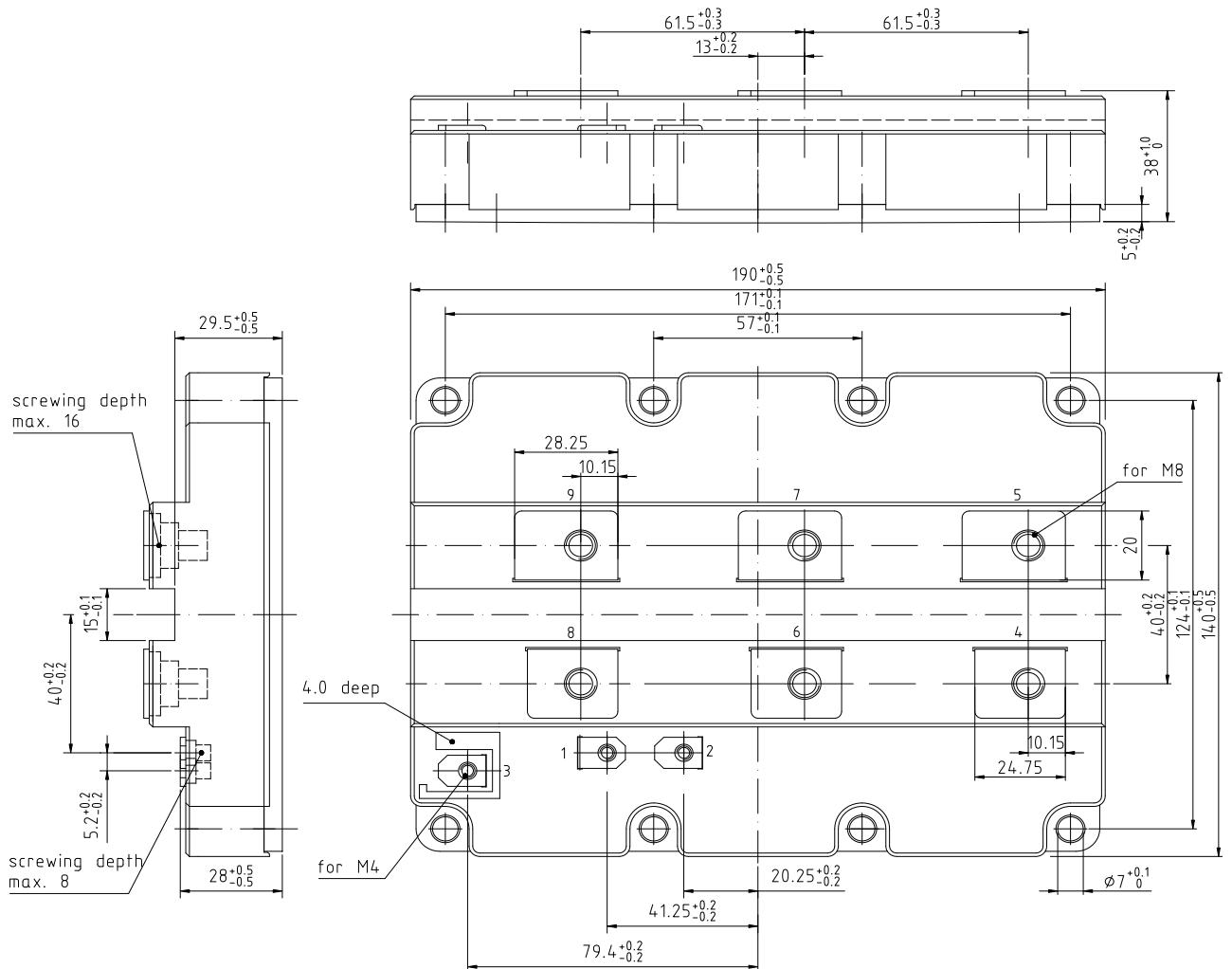

prepared by: SB	date of publication: 2013-12-11
approved by: DTS	revision: 3.1



この日本語は、あくまで参考訳となりますので、正式はデータシートに記載されている英文の物となります。

この日本語は、あくまで参考訳となりますので、正式はデータシートに記載されている英文の物となります。

利用規約

このデータシートに記載されているデータ類は、技術者向けの物です。このデバイスを使用される際は、製品が使用されるアプリケーションにて、ご評価頂いた上で、アプリケーションに適切にご判断願います。
このデータシートには、保証されている特性が記述されております。
その他、保証内容は個々の契約期間や条件に応じて決定されます。
保証は、アプリケーションやその特性に対しては行いません。
実際のアプリケーションでの利用に関しては、必ず相当モジュールのアセンブリノートをご確認ください。

追加の技術的情報、アプリケーションでの使用方法について、ご質問がある際には、最寄のセールスオフィスにお問い合わせ願います。(www.infineon.com 参照)
製品にご興味頂き必要があれば、アプリケーションノートを準備させて頂くケースもあります。
技術的な要求によっては、当該製品が危険な物になり得る可能性があります。このようなことが起こる可能性がある場合は、製品を使用される方の責任にて、弊社セールスオフィスに連絡願います。

航空関連、もしくは医療機器や生命維持装置に使用される場合は、インフィニオンと下記の項目を合意しているか、ご確認願います。
 ー リスク 及び 品質の評価
 ー 品質契約
 ー アプリケーションの共同評価
 上記の内容の状況に応じて、製品を出荷の判断をさせて頂く場合がございます。
 必要に応じて、この規約を関係される方々に送付してください。
 インフィニオンはこのデータシートを変更する権利を有します。

Terms & Conditions of usage

The data contained in this product data sheet is exclusively intended for technically trained staff. You and your technical departments will have to evaluate the suitability of the product for the intended application and the completeness of the product data with respect to such application.

This product data sheet is describing the characteristics of this product for which a warranty is granted. Any such warranty is granted exclusively pursuant the terms and conditions of the supply agreement. There will be no guarantee of any kind for the product and its characteristics. The information in the valid application- and assembly notes of the module must be considered.

Should you require product information in excess of the data given in this product data sheet or which concerns the specific application of our product, please contact the sales office, which is responsible for you (see www.infineon.com). For those that are specifically interested we may provide application notes.

Due to technical requirements our product may contain dangerous substances. For information on the types in question please contact the sales office, which is responsible for you.

Should you intend to use the Product in aviation applications, in health or live endangering or life support applications, please notify. Please note, that for any such applications we urgently recommend
 - to perform joint Risk and Quality Assessments;
 - the conclusion of Quality Agreements;
 - to establish joint measures of an ongoing product survey, and that we may make delivery depended on the realization of any such measures.

If and to the extent necessary, please forward equivalent notices to your customers.

Changes of this product data sheet are reserved.

prepared by: SB	date of publication: 2013-12-11
approved by: DTS	revision: 3.1