

## Final datasheet

### EconoDUAL™3 模块 采用第四代沟槽栅/场终止 IGBT4 和第三代发射极控制二极管

#### 特性

- 电气特性
  - $V_{CES} = 1700\text{ V}$
  - $I_{C\text{nom}} = 250\text{ A} / I_{CRM} = 500\text{ A}$
  - $V_{CESat}$  带正温度系数
  - 沟槽栅 IGBT4
  - 低  $V_{CESat}$
  - 高短路能力
  - 高直流电压稳定性
  - $T_{vj\text{op}} = 150^\circ\text{C}$
- 机械特性
  - 低热阻的三氧化二铝  $\text{Al}_2\text{O}_3$  衬底
  - 高功率密度
  - 绝缘的基板
  - PressFIT 压接技术

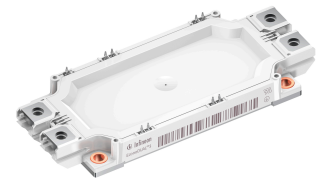

#### 可选应用

- 风力发电机
- 中压变流器
- 大功率变流器

#### 产品认证

- 根据 IEC 60747、60749 和 60068 标准的相关测试，符合工业应用的要求。

#### 描述

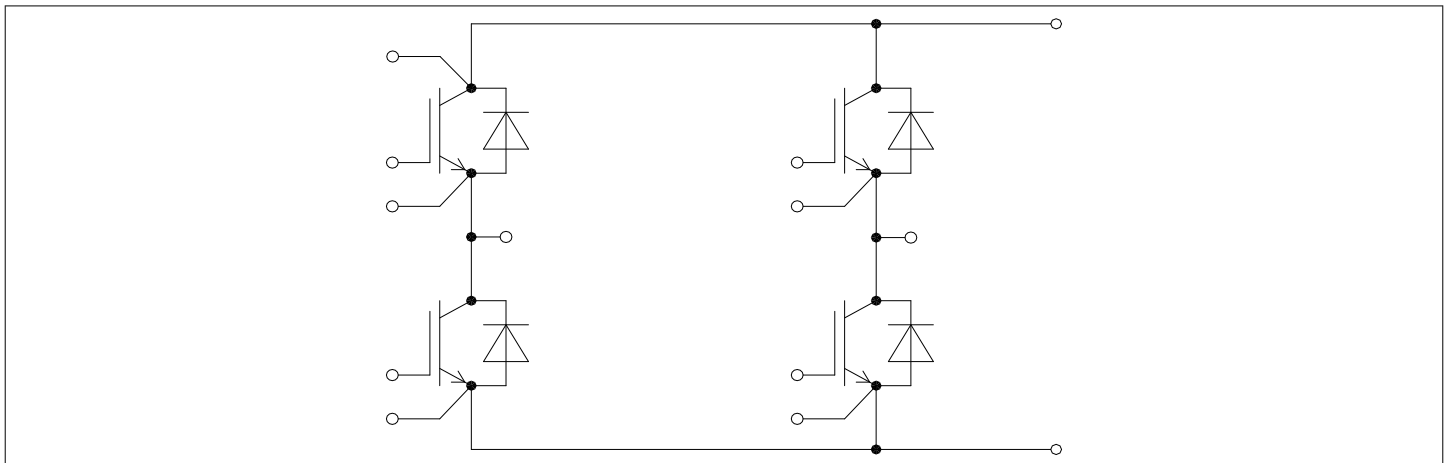

## 内容

|          |                        |    |
|----------|------------------------|----|
|          | 描述.....                | 1  |
|          | 特性.....                | 1  |
|          | 可选应用.....              | 1  |
|          | 产品认证.....              | 1  |
|          | 内容.....                | 2  |
| <b>1</b> | 封装.....                | 3  |
| <b>2</b> | <b>IGBT, 逆变器</b> ..... | 4  |
| <b>3</b> | <b>二极管, 逆变器</b> .....  | 5  |
| <b>4</b> | 特征参数图表.....            | 7  |
| <b>5</b> | 电路拓扑图.....             | 10 |
| <b>6</b> | 封装尺寸.....              | 11 |
| <b>7</b> | 模块标签代码.....            | 12 |
|          | 修订历史.....              | 13 |
|          | 免责声明.....              | 14 |

## 1 封装

## 1 封装

表 1 绝缘参数

| 特征参数       | 代号                      | 标注或测试条件  | 数值        | 单位 |
|------------|-------------------------|--|-----------|----|
| 绝缘测试电压     | $V_{ISOL}$              | RMS, $f = 50 \text{ Hz}$ , $t = 1 \text{ min}$ | 3.4       | kV |
| 模块基板材料     |                         |  | Cu        |    |
| 内部绝缘       |                         | 基本绝缘 (class 1, IEC 61140)                      | $Al_2O_3$ |    |
| 爬电距离       | $d_{Creep \text{ nom}}$ | 端子到基板, nom.,<br>(PD2, IEC 60664-1, Ed. 3.0)    | > 15      | mm |
| 爬电距离       | $d_{Creep \text{ min}}$ | 端子到基板, min.,<br>(PD2, IEC 60664-1, Ed. 3.0)    | 14.7      | mm |
| 爬电距离       | $d_{Creep \text{ nom}}$ | 端子至端子, nom.,<br>(PD2, IEC 60664-1, Ed. 3.0)    | 12.1      | mm |
| 爬电距离       | $d_{Creep \text{ min}}$ | 端子至端子, min.,<br>(PD2, IEC 60664-1, Ed. 3.0)    | 11.5      | mm |
| 电气间隙       | $d_{Clear \text{ nom}}$ | 端子到基板, nom.                                    | > 12.5    | mm |
| 电气间隙       | $d_{Clear \text{ min}}$ | 端子到基板, min.                                    | 12.5      | mm |
| 电气间隙       | $d_{Clear \text{ nom}}$ | 端子至端子, nom.                                    | 10.0      | mm |
| 电气间隙       | $d_{Clear \text{ min}}$ | 端子至端子, min.                                    | 9.6       | mm |
| 相对电痕指数     | $CTI$                   |  | > 200     |    |
| 相对温度指数 (电) | $RTI$                   | 封装   | 140       | °C |

表 2 特征值

| 特征参数      | 代号        | 标注或测试条件       | 数值     |     |     | 单位 |
|-----------|-----------|---------------|--------|-----|-----|----|
|           |           |               | 最小值    | 典型值 | 最大值 |    |
| 杂散电感, 模块  | $L_{SCE}$ |               |        | 26  |     | nH |
| 储存温度      | $T_{stg}$ |               | -40    |     | 125 | °C |
| 模块安装的安装扭矩 | $M$       | 根据相应的应用手册进行安装 | M5, 螺丝 | 3   | 6   | Nm |
| 端子安装扭矩    | $M$       | 根据相应的应用手册进行安装 | M6, 螺丝 | 3   | 6   | Nm |
| 重量        | $G$       |               |        | 345 |     | g  |

注: The labels AC and DC on the housing do not have relevance.

## 2 IGBT, 逆变器

表 3 最大标定值

| 特征参数       | 代号        | 标注或测试条件                       |                         | 数值       | 单位 |
|------------|-----------|-------------------------------|-------------------------|----------|----|
| 集电极-发射极电压  | $V_{CES}$ |                               | $T_{vj} = 25\text{ °C}$ | 1700     | V  |
| 连续集电极直流电流  | $I_{CDC}$ | $T_{vj\ max} = 175\text{ °C}$ | $T_C = 100\text{ °C}$   | 250      | A  |
| 集电极重复峰值电流  | $I_{CRM}$ | $t_p$ 受限于 $T_{vj\ op}$        |                         | 500      | A  |
| 栅极-发射极峰值电压 | $V_{GES}$ |                               |                         | $\pm 20$ | V  |

表 4 特征值

| 特征参数         | 代号            | 标注或测试条件   | 数值                       |       |      | 单位            |
|--------------|---------------|---|--------------------------|-------|------|---------------|
|              |               |   | 最小值                      | 典型值   | 最大值  |               |
| 集电极-发射极饱和电压  | $V_{CE\ sat}$ | $I_C = 250\text{ A}, V_{GE} = 15\text{ V}$  | $T_{vj} = 25\text{ °C}$  | 1.80  | 2.30 | V             |
|              |               |   | $T_{vj} = 125\text{ °C}$ | 2.15  |      |               |
|              |               |   | $T_{vj} = 150\text{ °C}$ | 2.30  |      |               |
| 栅极阈值电压       | $V_{Geth}$    | $I_C = 9.4\text{ mA}, V_{CE} = V_{GE}, T_{vj} = 25\text{ °C}$                               | 5.20                     | 5.80  | 6.40 | V             |
| 栅极电荷         | $Q_G$         | $V_{GE} = \pm 15\text{ V}$  |                          | 2.25  |      | $\mu\text{C}$ |
| 内部栅极电阻       | $R_{Gint}$    | $T_{vj} = 25\text{ °C}$   |                          | 5.8   |      | $\Omega$      |
| 输入电容         | $C_{ies}$     | $f = 1000\text{ kHz}, T_{vj} = 25\text{ °C}, V_{CE} = 25\text{ V}, V_{GE} = 0\text{ V}$     |                          | 21    |      | nF            |
| 反向传输电容       | $C_{res}$     | $f = 1000\text{ kHz}, T_{vj} = 25\text{ °C}, V_{CE} = 25\text{ V}, V_{GE} = 0\text{ V}$     |                          | 0.68  |      | nF            |
| 集电极-发射极截止电流  | $I_{CES}$     | $V_{CE} = 1700\text{ V}, V_{GE} = 0\text{ V}$   | $T_{vj} = 25\text{ °C}$  |       | 3    | mA            |
| 栅极-发射极漏电流    | $I_{GES}$     | $V_{CE} = 0\text{ V}, V_{GE} = 20\text{ V}, T_{vj} = 25\text{ °C}$                          |                          |       | 400  | nA            |
| 开通延迟时间(感性负载) | $t_{don}$     | $I_C = 250\text{ A}, V_{CC} = 900\text{ V}, V_{GE} = \pm 15\text{ V}, R_{Gon} = 1\ \Omega$  | $T_{vj} = 25\text{ °C}$  | 0.360 |      | $\mu\text{s}$ |
|              |               |   | $T_{vj} = 125\text{ °C}$ | 0.400 |      |               |
|              |               |   | $T_{vj} = 150\text{ °C}$ | 0.400 |      |               |
| 上升时间(感性负载)   | $t_r$         | $I_C = 250\text{ A}, V_{CC} = 900\text{ V}, V_{GE} = \pm 15\text{ V}, R_{Gon} = 1\ \Omega$  | $T_{vj} = 25\text{ °C}$  | 0.070 |      | $\mu\text{s}$ |
|              |               |   | $T_{vj} = 125\text{ °C}$ | 0.080 |      |               |
|              |               |   | $T_{vj} = 150\text{ °C}$ | 0.080 |      |               |
| 关断延迟时间(感性负载) | $t_{doff}$    | $I_C = 250\text{ A}, V_{CC} = 900\text{ V}, V_{GE} = \pm 15\text{ V}, R_{Goff} = 1\ \Omega$ | $T_{vj} = 25\text{ °C}$  | 0.630 |      | $\mu\text{s}$ |
|              |               |   | $T_{vj} = 125\text{ °C}$ | 0.780 |      |               |
|              |               |   | $T_{vj} = 150\text{ °C}$ | 0.820 |      |               |
| 下降时间(感性负载)   | $t_f$         | $I_C = 250\text{ A}, V_{CC} = 900\text{ V}, V_{GE} = \pm 15\text{ V}, R_{Goff} = 1\ \Omega$ | $T_{vj} = 25\text{ °C}$  | 0.150 |      | $\mu\text{s}$ |
|              |               |   | $T_{vj} = 125\text{ °C}$ | 0.200 |      |               |
|              |               |   | $T_{vj} = 150\text{ °C}$ | 0.210 |      |               |

(待续)

表 4 (续) 特征值

| 特征参数         | 代号         | 标注或测试条件   |  | 数值  |        |       | 单位               |
|--------------|------------|---|--|---|--------|-------|------------------|
|              |            |   |  | 最小值   | 典型值    | 最大值   |                  |
| 开通损耗能量 (每脉冲) | $E_{on}$   | $I_C = 250\text{ A}, V_{CC} = 900\text{ V},$<br>$L_\sigma = 35\text{ nH}, V_{GE} = \pm 15\text{ V},$<br>$R_{Gon} = 1\ \Omega, di/dt = 2700$<br>$\text{A}/\mu\text{s} (T_{vj} = 150\text{ }^\circ\text{C})$  |  | $T_{vj} = 25\text{ }^\circ\text{C}$                                 | 77     |       | mJ               |
|              |            |   |  | $T_{vj} = 125\text{ }^\circ\text{C}$                                | 105    |       |                  |
|              |            |   |  | $T_{vj} = 150\text{ }^\circ\text{C}$                                | 115    |       |                  |
| 关断损耗能量 (每脉冲) | $E_{off}$  | $I_C = 250\text{ A}, V_{CC} = 900\text{ V},$<br>$L_\sigma = 35\text{ nH}, V_{GE} = \pm 15\text{ V},$<br>$R_{Goff} = 1\ \Omega, dv/dt = 2600$<br>$\text{V}/\mu\text{s} (T_{vj} = 150\text{ }^\circ\text{C})$ |  | $T_{vj} = 25\text{ }^\circ\text{C}$                                 | 79     |       | mJ               |
|              |            |   |  | $T_{vj} = 125\text{ }^\circ\text{C}$                                | 110    |       |                  |
|              |            |   |  | $T_{vj} = 150\text{ }^\circ\text{C}$                                | 120    |       |                  |
| 短路数据         | $I_{SC}$   | $V_{GE} \leq 15\text{ V}, V_{CC} = 1000\text{ V},$<br>$V_{CEmax} = V_{CES} - L_{sCE} * di/dt$   |  | $t_p \leq 10\ \mu\text{s},$<br>$T_{vj} = 150\text{ }^\circ\text{C}$ | 1300   |       | A                |
| 结-外壳热阻       | $R_{thJC}$ | 每个 IGBT   |  |   |        | 0.101 | K/W              |
| 外壳-散热器热阻     | $R_{thCH}$ | 每个 IGBT, $\lambda_{grease} = 1\text{ W}/(\text{m}\cdot\text{K})$  |  |   | 0.0800 |       | K/W              |
| 允许开关的温度范围    | $T_{vjop}$ |   |  | -40   |        | 150   | $^\circ\text{C}$ |

### 3 二极管,逆变器

表 5 最大标定值

| 特征参数     | 代号        | 标注或测试条件                                |                                     | 数值                                   | 单位    |                      |
|----------|-----------|--|-------------------------------------|--------------------------------------|-------|----------------------|
| 反向重复峰值电压 | $V_{RRM}$ |  | $T_{vj} = 25\text{ }^\circ\text{C}$ | 1700                                 | V     |                      |
| 连续正向直流电流 | $I_F$     |  |                                     | 250                                  | A     |                      |
| 正向重复峰值电流 | $I_{FRM}$ | $t_p = 1\text{ ms}$                    |                                     | 500                                  | A     |                      |
| I2t-值    | $I^2t$    | $t_p = 10\text{ ms}, V_R = 0\text{ V}$ |                                     | $T_{vj} = 125\text{ }^\circ\text{C}$ | 11000 | $\text{A}^2\text{s}$ |
|          |           |  |                                     | $T_{vj} = 150\text{ }^\circ\text{C}$ | 10000 |                      |

表 6 特征值

| 特征参数     | 代号       | 标注或测试条件   |  | 数值                                   |      |      | 单位 |
|----------|----------|---|--|--------------------------------------|------|------|----|
|          |          |   |  | 最小值                                  | 典型值  | 最大值  |    |
| 正向电压     | $V_F$    | $I_F = 250\text{ A}, V_{GE} = 0\text{ V}$   |  | $T_{vj} = 25\text{ }^\circ\text{C}$  | 1.80 | 2.55 | V  |
|          |          |   |  | $T_{vj} = 125\text{ }^\circ\text{C}$ | 1.85 |      |    |
|          |          |   |  | $T_{vj} = 150\text{ }^\circ\text{C}$ | 1.85 |      |    |
| 反向恢复峰值电流 | $I_{RM}$ | $V_{CC} = 900\text{ V}, I_F = 250\text{ A},$<br>$V_{GE} = -15\text{ V}, -di_F/dt =$<br>$2700\text{ A}/\mu\text{s} (T_{vj} = 150\text{ }^\circ\text{C})$ |  | $T_{vj} = 25\text{ }^\circ\text{C}$  | 240  |      | A  |
|          |          |   |  | $T_{vj} = 125\text{ }^\circ\text{C}$ | 250  |      |    |
|          |          |   |  | $T_{vj} = 150\text{ }^\circ\text{C}$ | 255  |      |    |

(待续)

表 6 (续) 特征值

| 特征参数         | 代号          | 标注或测试条件  | 数值                                    |       |       | 单位               |
|--------------|-------------|--|---------------------------------------|-------|-------|------------------|
|              |             |  | 最小值                                   | 典型值   | 最大值   |                  |
| 恢复电荷         | $Q_r$       | $V_{CC} = 900 \text{ V}, I_F = 250 \text{ A},$<br>$V_{GE} = -15 \text{ V}, -di_F/dt =$<br>$2700 \text{ A}/\mu\text{s} (T_{vj} = 150 \text{ }^\circ\text{C})$ | $T_{vj} = 25 \text{ }^\circ\text{C}$  | 63    |       | $\mu\text{C}$    |
|              |             |  | $T_{vj} = 125 \text{ }^\circ\text{C}$ | 100   |       |                  |
|              |             |  | $T_{vj} = 150 \text{ }^\circ\text{C}$ | 115   |       |                  |
| 反向恢复损耗 (每脉冲) | $E_{rec}$   | $V_{CC} = 900 \text{ V}, I_F = 250 \text{ A},$<br>$V_{GE} = -15 \text{ V}, -di_F/dt =$<br>$2700 \text{ A}/\mu\text{s} (T_{vj} = 150 \text{ }^\circ\text{C})$ | $T_{vj} = 25 \text{ }^\circ\text{C}$  | 29.5  |       | mJ               |
|              |             |  | $T_{vj} = 125 \text{ }^\circ\text{C}$ | 52.5  |       |                  |
|              |             |  | $T_{vj} = 150 \text{ }^\circ\text{C}$ | 60    |       |                  |
| 结-外壳热阻       | $R_{thJC}$  | 每个二极管  |                                       |       | 0.215 | K/W              |
| 外壳-散热器热阻     | $R_{thCH}$  | 每个二极管, $\lambda_{grease} = 1 \text{ W}/(\text{m}\cdot\text{K})$  |                                       | 0.126 |       | K/W              |
| 允许开关的温度范围    | $T_{vj op}$ |  | -40                                   |       | 150   | $^\circ\text{C}$ |

4 特征参数图表

输出特性 (典型), IGBT, 逆变器

$I_C = f(V_{CE})$

$V_{GE} = 15\text{ V}$

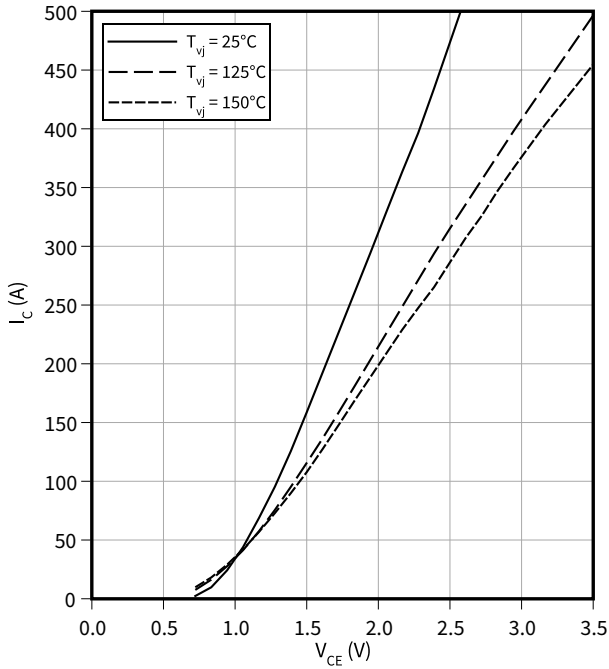

输出特性 (典型), IGBT, 逆变器

$I_C = f(V_{CE})$

$T_{vj} = 150\text{ °C}$

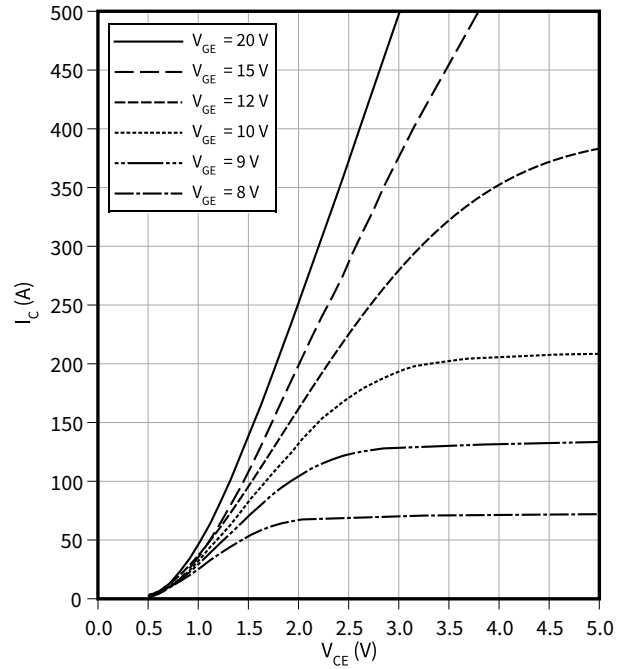

传输特性 (典型), IGBT, 逆变器

$I_C = f(V_{GE})$

$V_{CE} = 20\text{ V}$

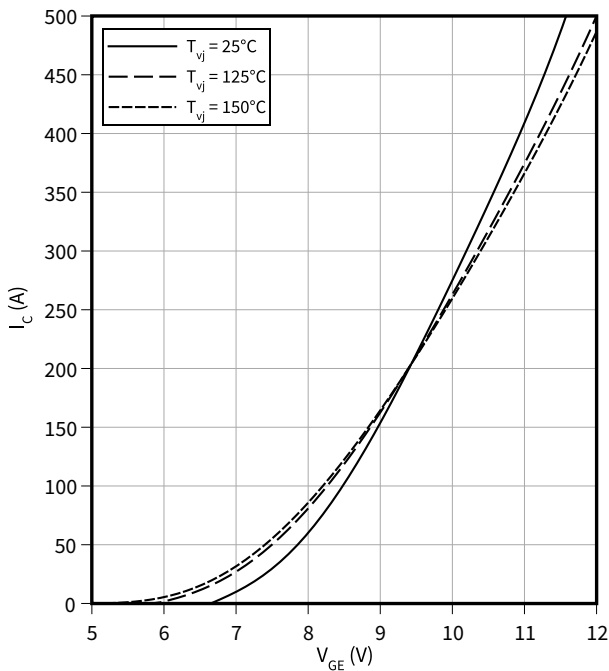

开关损耗 (典型), IGBT, 逆变器

$E = f(I_C)$

$V_{CC} = 900\text{ V}, R_{Goff} = 1\ \Omega, R_{Gon} = 1\ \Omega, V_{GE} = \pm 15\text{ V}$

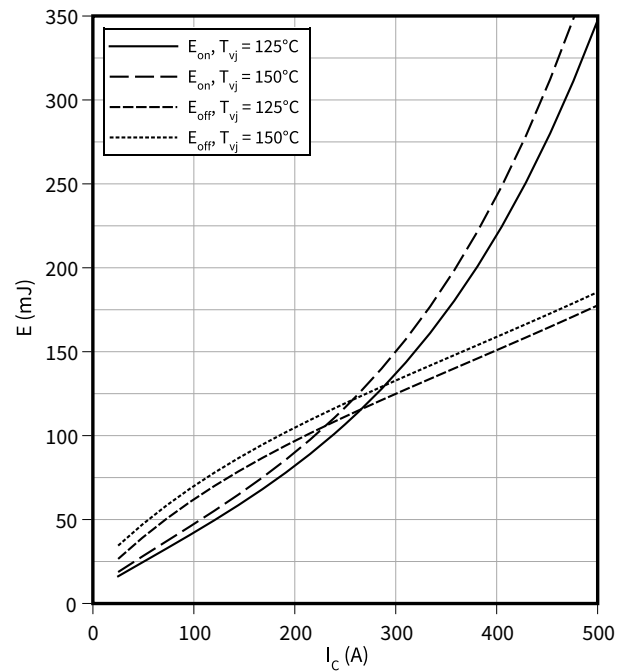

4 特征参数图表

开关损耗 (典型), IGBT, 逆变器

$E = f(R_G)$

$V_{GE} = \pm 15 \text{ V}, I_C = 250 \text{ A}, V_{CC} = 900 \text{ V}$

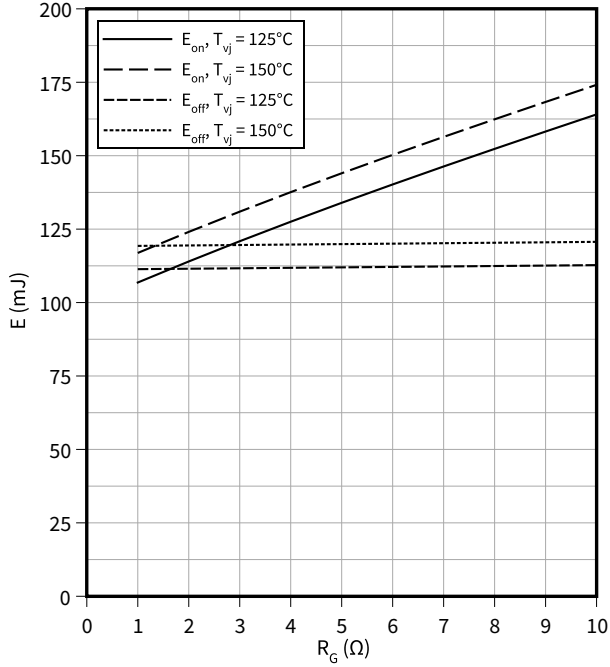

反偏安全工作区 (RBSOA), IGBT, 逆变器

$I_C = f(V_{CE})$

$R_{Goff} = 1 \Omega, V_{GE} = \pm 15 \text{ V}, T_{vj} = 150 \text{ }^\circ\text{C}$

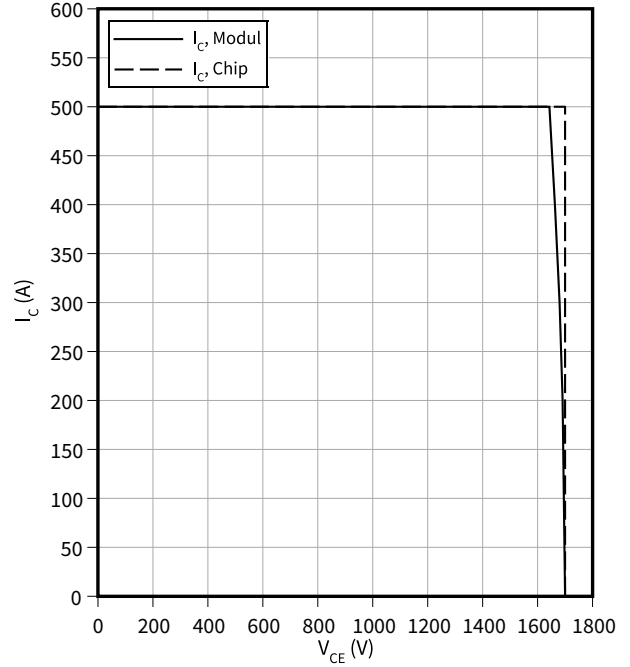

瞬态热阻抗, IGBT, 逆变器

$Z_{th} = f(t)$

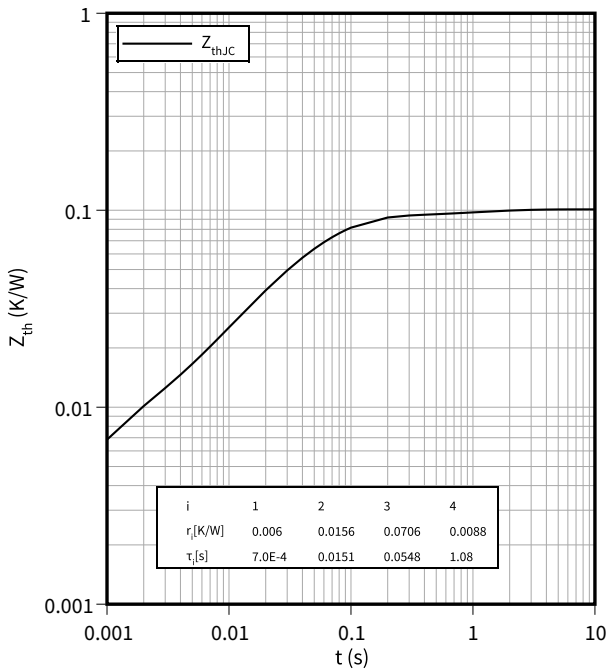

正向特性 (典型), 二极管, 逆变器

$I_F = f(V_F)$

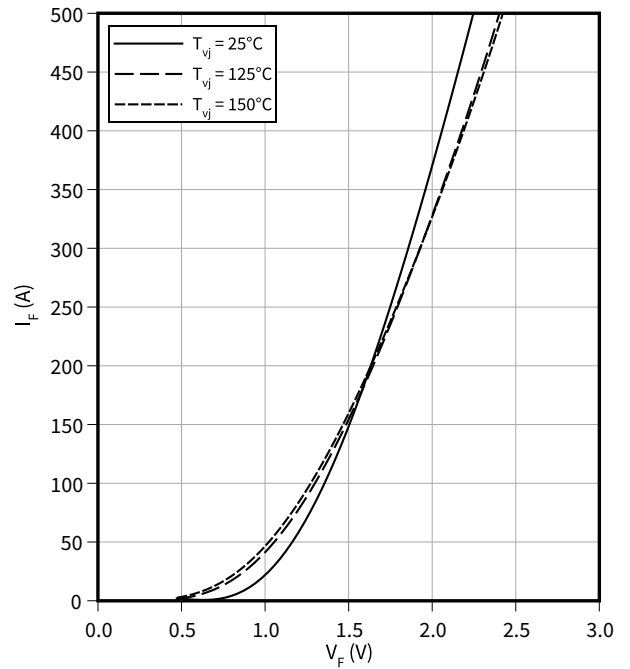



4 特征参数图表

开关损耗 (典型), 二极管, 逆变器

$E_{rec} = f(I_F)$

$R_{Gon} = 1 \Omega, V_{CC} = 900 V$

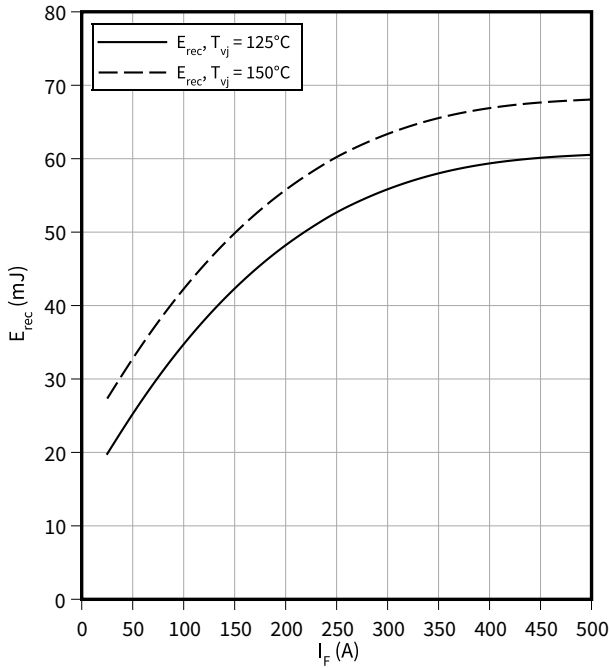

开关损耗 (典型), 二极管, 逆变器

$E_{rec} = f(R_G)$

$I_F = 250 A, V_{CC} = 900 V$

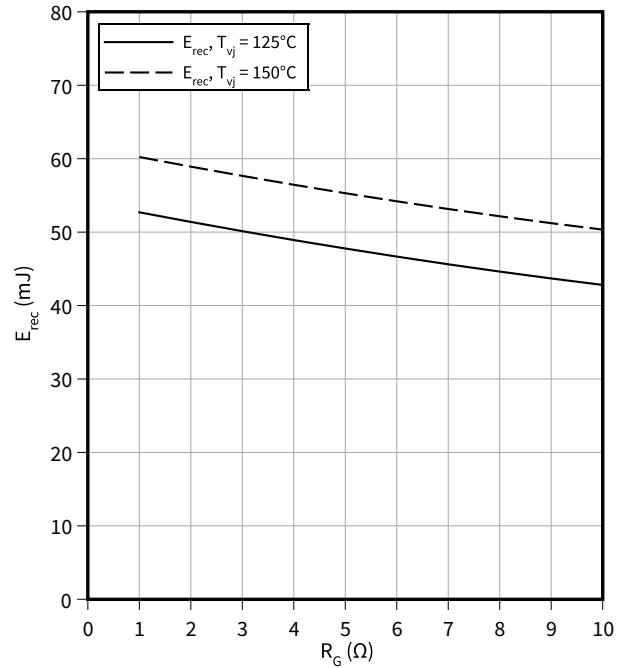

瞬态热阻抗, 二极管, 逆变器

$Z_{th} = f(t)$

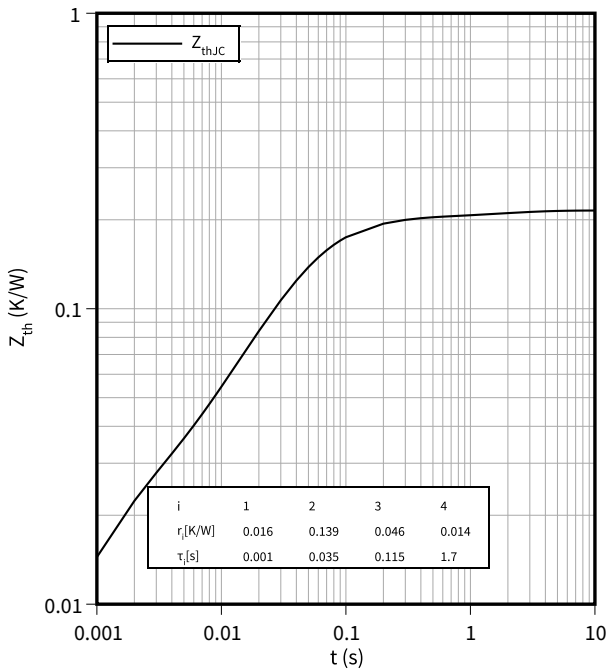

### 5 电路拓扑图



图 1



## 7 模块标签代码

| Module label code |  |                 |   |
|-------------------|--|-----------------|---|
| Code format       | Data Matrix  | Barcode Code128 |   |
| Encoding          | ASCII text   | Code Set A      |   |
| Symbol size       | 16x16  | 23 digits       |   |
| Standard          | IEC24720 and IEC16022  | IEC8859-1       |   |
| Code content      | Content  | Digit           | Example   |
|                   | Module serial number   | 1 -5            | 71549   |
|                   | Module material number   | 6 - 11          | 142846  |
|                   | Production order number  | 12 - 19         | 55054991  |
|                   | Date code (production year)  | 20 -21          | 15  |
|                   | Date code (production week)  | 22 -23          | 30  |
| Example           |  |                 |  |
|                   | 71549142846550549911530  |                 | 71549142846550549911530   |

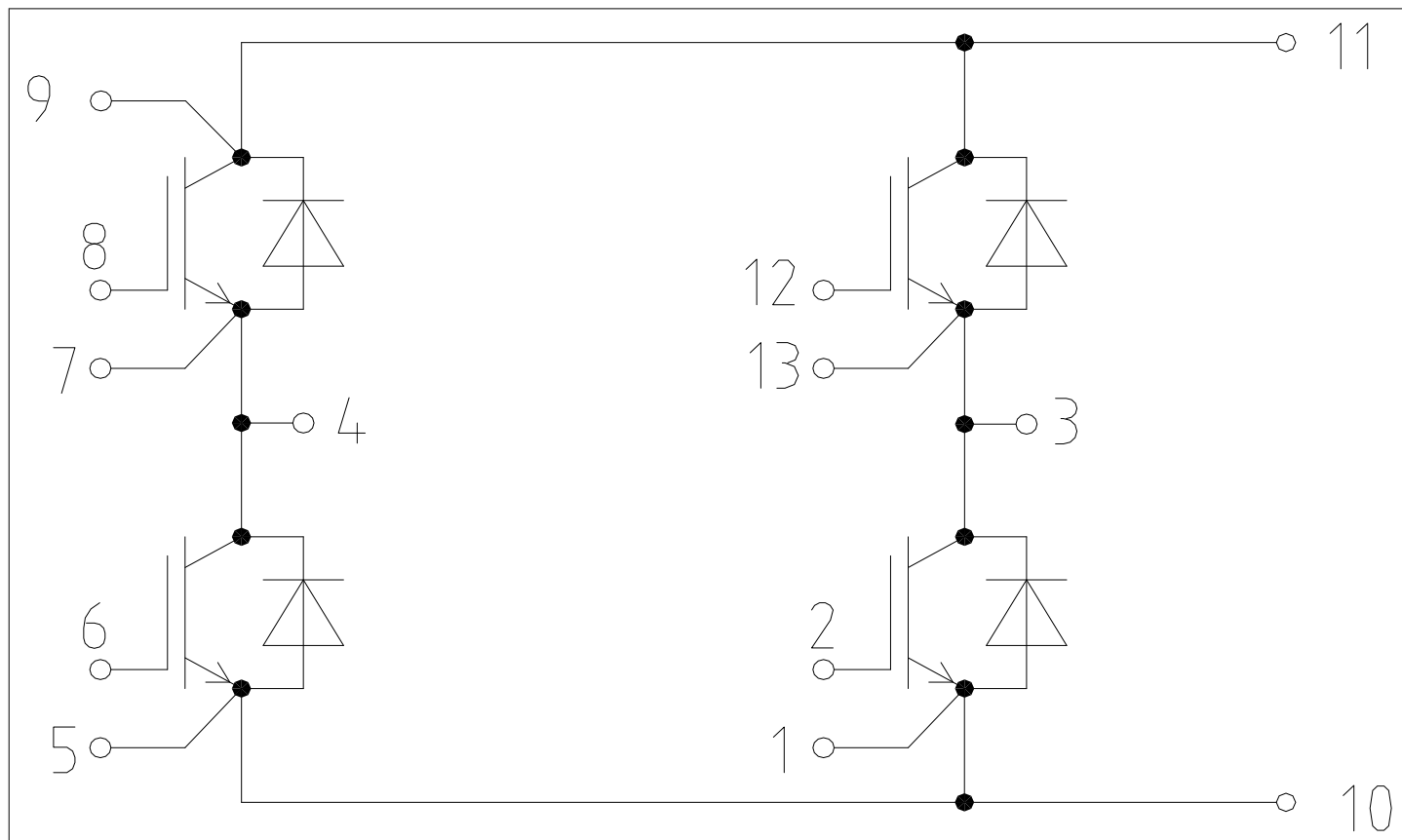
图 3

## 修订历史

| 修订版本 | 发布日期       | 变更说明  |
|------|------------|---|
| V1.0 | 2012-08-22 | Target datasheet  |
| V1.1 | 2012-12-19 | Target datasheet  |
| V1.2 | 2013-01-07 | Target datasheet  |
| V1.3 | 2014-07-22 | Target datasheet  |
| V1.4 | 2014-12-01 | Target datasheet  |
| V1.5 | 2015-12-02 | Target datasheet  |
| V3.0 | 2016-04-18 | Final datasheet   |
| V3.1 | 2017-09-07 | Final datasheet   |
| V3.2 | 2017-09-18 | Final datasheet   |
| n/a  | 2020-09-01 | Datasheet migrated to a new system with a new layout and new revision number schema: target or preliminary datasheet = 0.xy; final datasheet = 1.xy |
| 1.10 | 2024-03-18 | Final datasheet   |

## Trademarks

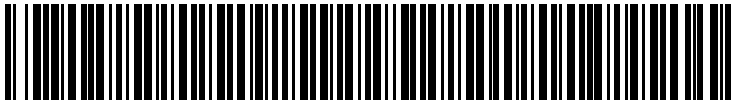
All referenced product or service names and trademarks are the property of their respective owners.

**Edition 2024-03-18**

**Published by  
Infineon Technologies AG  
81726 Munich, Germany**

**© 2024 Infineon Technologies AG  
All Rights Reserved.**

**Do you have a question about any  
aspect of this document?**

**Email: [erratum@infineon.com](mailto:erratum@infineon.com)**

**Document reference  
IFX-AAX165-010**

## 重要提示

本文档所提供的任何信息绝不应被视为针对任何条件或者品质而做出的保证（质量保证）。

英飞凌对于本文档中所提及的任何事例、提示或者任何特定数值及/或任何关于产品应用方面的信息均在此明确声明其不承担任何保证或者责任，包括但不限于其不侵犯任何第三方知识产权的保证均在此排除。

此外，本文档所提供的任何信息均取决于客户履行本文档所载明的义务和客户遵守适用于客户产品以及与客户对于英飞凌产品的应用所相关的任何法律要求、规范和标准。

本文档所含的数据仅供经过专业技术培训的人员使用。客户自身的技术部门有义务对于产品是否适宜于其预期的应用和针对该等应用而言本文档中所提供的信息是否充分自行予以评估。

## 警告事项

由于技术所需产品可能含有危险物质。如需了解该等物质的类型，请向离您最近的英飞凌科技办公室接洽。

除非由经英飞凌科技授权代表签署的书面文件中做出另行明确批准的情况外，英飞凌科技的产品不应被用于任何一项一旦产品失效或者产品使用的后当被用于任何一项一旦产品失效或者产品使用的后领域。