

EasyPACK™ モジュール CoolSiC™ Trench MOSFET 内蔵 と PressFIT / NTCサーミスタ
 EasyPACK™ module with CoolSiC™ Trench MOSFET and PressFIT / NTC

暫定データ / Preliminary Data

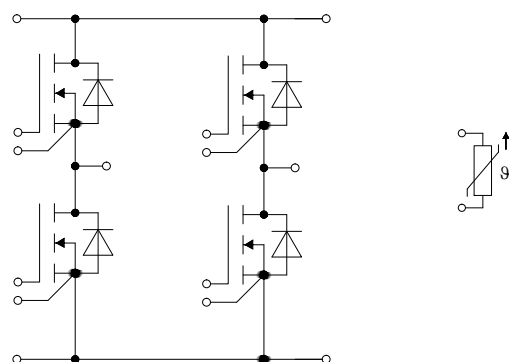
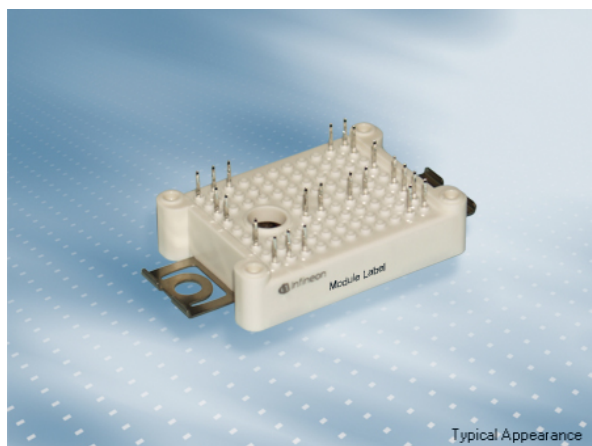

$V_{DSS} = 1200V$
 $I_{D\ nom} = 50A / I_{DRM} = 100A$

アプリケーションの可能性

- DC/DCコンバーター
- 溶接機
- 高周波スイッチングアプリケーション

Potential Applications

- DC/DC converter
- Welding
- High Frequency Switching application

電気的特性

- 低インダクタンス設計
- 低スイッチング損失
- 高い電流密度

Electrical Features

- Low inductive design
- Low switching losses
- High current density

機械的特性

- PressFIT 接合 技術
- 内蔵されたNTCサーミスタ
- 固定用クランプによる強固なマウンティング

Mechanical Features

- PressFIT contact technology
- Integrated NTC temperature sensor
- Rugged mounting due to integrated mounting clamps

Module Label Code

Barcode Code 128



DMX - Code



Content of the Code

Content of the Code	Digit
Module Serial Number	1 - 5
Module Material Number	6 - 11
Production Order Number	12 - 19
Datecode (Production Year)	20 - 21
Datecode (Production Week)	22 - 23

暫定データ Preliminary Data

MOSFET / MOSFET

最大定格 / Maximum Rated Values

ドレイン・ソース間電圧 Drain-source voltage	$T_{vj} = 25^{\circ}\text{C}$	V_{DSS}	1200	V
DCドレイン電流 DC drain current	$T_{vj} = 175^{\circ}\text{C}, V_{GS} = 15\text{ V}$	$T_H = 60^{\circ}\text{C}$	$I_{D\text{ nom}}$	50 A
パルスドレイン電流 Pulsed drain current	設計による検証 (t_p は $T_{vj\text{ max}}$ により制限される) verified by design, t_p limited by $T_{vj\text{ max}}$		$I_{D\text{ pulse}}$	100 A
ゲート・ソース間ピーク電圧 Gate-source voltage		V_{GSS}	-10 / 20	V

電気的特性 / Characteristic Values

			min.	typ.	max.	
ドレイン・ソース間オン抵抗 Drain-source on resistance	$I_D = 50\text{ A}$ $V_{GS} = 15\text{ V}$	$T_{vj} = 25^{\circ}\text{C}$ $T_{vj} = 125^{\circ}\text{C}$ $T_{vj} = 150^{\circ}\text{C}$	$R_{DS\text{ on}}$	22,5 29,5 33,0		m Ω
ゲートしきい値電圧 Gate threshold voltage	$I_D = 20,0\text{ mA}, V_{DS} = V_{GS}, T_{vj} = 25^{\circ}\text{C}$ (tested after 1ms pulse at $V_{GS} = +20\text{ V}$)		$V_{GS(th)}$	3,45	4,50	5,55 V
総ゲート入力電荷量 Total gate charge	$V_{GS} = -5\text{ V} / 15\text{ V}, V_{DS} = 800\text{ V}$		Q_G	0,124		μC
内蔵ゲート抵抗 Internal gate resistor	$T_{vj} = 25^{\circ}\text{C}$		R_{Gint}	2,0		Ω
入力容量 Input capacitance	$f = 1\text{ MHz}, T_{vj} = 25^{\circ}\text{C}$ $V_{DS} = 800\text{ V}, V_{GS} = 0\text{ V}, V_{AC} = 25\text{ mV}$		C_{iss}	3,68		nF
出力容量 Output capacitance	$f = 1\text{ MHz}, T_{vj} = 25^{\circ}\text{C}$ $V_{DS} = 800\text{ V}, V_{GS} = 0\text{ V}, V_{AC} = 25\text{ mV}$		C_{oss}	0,22		nF
帰還容量 Reverse transfer capacitance	$f = 1\text{ MHz}, T_{vj} = 25^{\circ}\text{C}$ $V_{DS} = 800\text{ V}, V_{GS} = 0\text{ V}, V_{AC} = 25\text{ mV}$		C_{rss}	0,028		nF
C_{oss} stored energy	$T_{vj} = 25^{\circ}\text{C}$ $V_{DS} = 800\text{ V}, V_{GS} = -5\text{ V} / 15\text{ V}$		E_{oss}	88,0		μJ
Vg=0V時、ドレイン電流 Zero gate voltage drain current	$V_{DS} = 1200\text{ V}, V_{GS} = -5\text{ V}$	$T_{vj} = 25^{\circ}\text{C}$	I_{DSS}	0,20	210	μA
ゲート・ソース間漏れ電流 Gate-source leakage current	$V_{DS} = 0\text{ V}$ $T_{vj} = 25^{\circ}\text{C}$	$V_{GS} = 20\text{ V}$ $V_{GS} = -10\text{ V}$	I_{GSS}		400	nA
ターンオン遅延時間 (誘導負荷) Turn on delay time, inductive load	$I_D = 50\text{ A}, V_{DS} = 600\text{ V}$ $V_{GS} = -5\text{ V} / 15\text{ V}$ $R_{Gon} = 1,00\ \Omega$	$T_{vj} = 25^{\circ}\text{C}$ $T_{vj} = 125^{\circ}\text{C}$ $T_{vj} = 150^{\circ}\text{C}$	$t_{d\text{ on}}$	14,3 14,3 14,3		ns
ターンオン上昇時間 (誘導負荷) Rise time, inductive load	$I_D = 50\text{ A}, V_{DS} = 600\text{ V}$ $V_{GS} = -5\text{ V} / 15\text{ V}$ $R_{Gon} = 1,00\ \Omega$	$T_{vj} = 25^{\circ}\text{C}$ $T_{vj} = 125^{\circ}\text{C}$ $T_{vj} = 150^{\circ}\text{C}$	t_r	8,40 8,40 8,40		ns
ターンオフ遅延時間 (誘導負荷) Turn off delay time, inductive load	$I_D = 50\text{ A}, V_{DS} = 600\text{ V}$ $V_{GS} = -5\text{ V} / 15\text{ V}$ $R_{Goff} = 1,00\ \Omega$	$T_{vj} = 25^{\circ}\text{C}$ $T_{vj} = 125^{\circ}\text{C}$ $T_{vj} = 150^{\circ}\text{C}$	$t_{d\text{ off}}$	49,4 49,4 49,4		ns
ターンオフ下降時間 (誘導負荷) Fall time, inductive load	$I_D = 50\text{ A}, V_{DS} = 600\text{ V}$ $V_{GS} = -5\text{ V} / 15\text{ V}$ $R_{Goff} = 1,00\ \Omega$	$T_{vj} = 25^{\circ}\text{C}$ $T_{vj} = 125^{\circ}\text{C}$ $T_{vj} = 150^{\circ}\text{C}$	t_f	11,5 11,5 11,5		ns
ターンオンスイッチング損失/パルス Turn-on energy loss per pulse	$I_D = 50\text{ A}, V_{DS} = 600\text{ V}, L\sigma = 35\text{ nH}$ $di/dt = 8,30\text{ kA}/\mu\text{s}$ ($T_{vj} = 150^{\circ}\text{C}$) $V_{GS} = -5\text{ V} / 15\text{ V}, R_{Gon} = 1,00\ \Omega$	$T_{vj} = 25^{\circ}\text{C}$ $T_{vj} = 125^{\circ}\text{C}$ $T_{vj} = 150^{\circ}\text{C}$	E_{on}	0,43 0,43 0,43		mJ
ターンオフスイッチング損失/パルス Turn-off energy loss per pulse	$I_D = 50\text{ A}, V_{DS} = 600\text{ V}, L\sigma = 35\text{ nH}$ $du/dt = 46,2\text{ kV}/\mu\text{s}$ ($T_{vj} = 150^{\circ}\text{C}$) $V_{GS} = -5\text{ V} / 15\text{ V}, R_{Goff} = 1,00\ \Omega$	$T_{vj} = 25^{\circ}\text{C}$ $T_{vj} = 125^{\circ}\text{C}$ $T_{vj} = 150^{\circ}\text{C}$	E_{off}	0,11 0,11 0,11		mJ
ジャンクション・ヒートシンク間熱抵抗 Thermal resistance, junction to heatsink	MOSFET (1素子当り) / per MOSFET		R_{thJH}	0,900		K/W
動作温度 Temperature under switching conditions		$T_{vj\text{ op}}$	-40		150	$^{\circ}\text{C}$

Body diode

最大定格 / Maximum Rated Values

DC body diode forward current	$T_{vj} = 175^{\circ}\text{C}, V_{GS} = -5\text{ V}$	$T_H = 60^{\circ}\text{C}$	I_{SD}	16	A
-------------------------------	--	----------------------------	----------	----	---

電気的特性 / Characteristic Values

			min.	typ.	max.	
順電圧 Forward voltage	$I_{SD} = 50\text{ A}, V_{GS} = -5\text{ V}$ $I_{SD} = 50\text{ A}, V_{GS} = -5\text{ V}$ $I_{SD} = 50\text{ A}, V_{GS} = -5\text{ V}$	$T_{vj} = 25^{\circ}\text{C}$ $T_{vj} = 125^{\circ}\text{C}$ $T_{vj} = 150^{\circ}\text{C}$	V_{SD}	4,60 4,35 4,30	5,65	V

暫定データ Preliminary Data

NTC-サーミスタ / NTC-Thermistor

電気的特性 / Characteristic Values

			min.	typ.	max.	
定格抵抗値 Rated resistance	$T_{NTC} = 25^{\circ}\text{C}$	R_{25}		5,00		k Ω
R100の偏差 Deviation of R100	$T_{NTC} = 100^{\circ}\text{C}, R_{100} = 493 \Omega$	$\Delta R/R$	-5		5	%
損失 Power dissipation	$T_{NTC} = 25^{\circ}\text{C}$	P_{25}			20,0	mW
B-定数 B-value	$R_2 = R_{25} \exp [B_{25/50}(1/T_2 - 1/(298,15 \text{ K}))]$	$B_{25/50}$		3375		K
B-定数 B-value	$R_2 = R_{25} \exp [B_{25/80}(1/T_2 - 1/(298,15 \text{ K}))]$	$B_{25/80}$		3411		K
B-定数 B-value	$R_2 = R_{25} \exp [B_{25/100}(1/T_2 - 1/(298,15 \text{ K}))]$	$B_{25/100}$		3433		K

適切なアプリケーションノートによる仕様
Specification according to the valid application note.

モジュール / Module

絶縁耐圧 Isolation test voltage	RMS, f = 50 Hz, t = 1 min.	V_{ISOL}		3,0		kV
内部絶縁 Internal isolation	基礎絶縁 (クラス1, IEC 61140) basic insulation (class 1, IEC 61140)			Al ₂ O ₃		
沿面距離 Creepage distance	連絡方法 - ヒートシンク / terminal to heatsink 連絡方法 - 連絡方法 / terminal to terminal			11,5 6,3		mm
空間距離 Clearance	連絡方法 - ヒートシンク / terminal to heatsink 連絡方法 - 連絡方法 / terminal to terminal			10,0 5,0		mm
相対トラッキング指数 Comperative tracking index		CTI		> 200		
相対温度指数 (電気) RTI Elec.	住宅 housing	RTI		140		°C
			min.	typ.	max.	
内部インダクタンス Stray inductance module		L_{sCE}		10		nH
保存温度 Storage temperature		T_{stg}	-40		125	°C
Anpresskraft für mech. Bef. pro Feder mounting force per clamp		F	20	-	50	N
質量 Weight		G		24		g

The current under continuous operation is limited to 25 A rms per connector pin.

Important note: The selection of positive and negative gate-source voltages impacts the long-term behavior of the device. The design guidelines described in Application Note AN 2018-09 must be considered to ensure sound operation of the device over the planned lifetime.

暫定データ Preliminary Data

出力特性 MOSFET (Typical)
output characteristic MOSFET (typical)

$I_D = f(V_{DS})$
 $V_{GS} = 15\text{ V}$

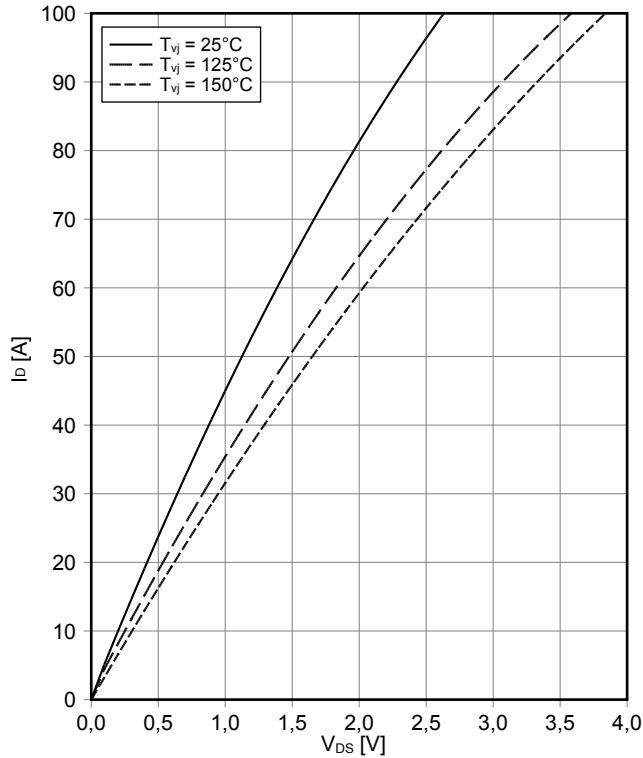

伝達特性 MOSFET (Typical)
transfer characteristic MOSFET (typical)

$I_D = f(V_{GS})$
 $V_{DS} = 20\text{ V}$

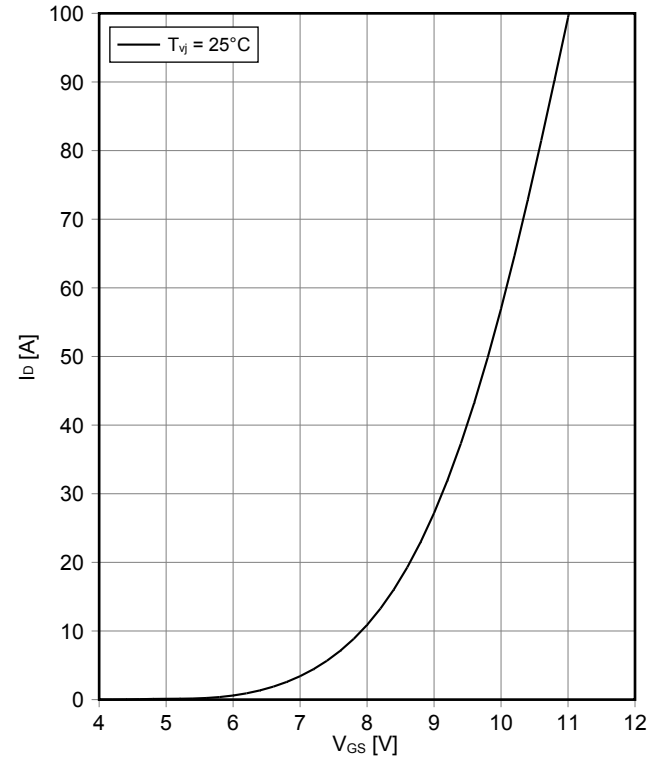

スイッチング損失 MOSFET (Typical)
switching losses MOSFET (typical)

$E_{on} = f(I_D)$, $E_{off} = f(I_D)$
 $V_{GS} = -5\text{ V} / 15\text{ V}$, $R_{Gon} = 1\ \Omega$, $R_{Goff} = 1\ \Omega$, $V_{DS} = 600\text{ V}$

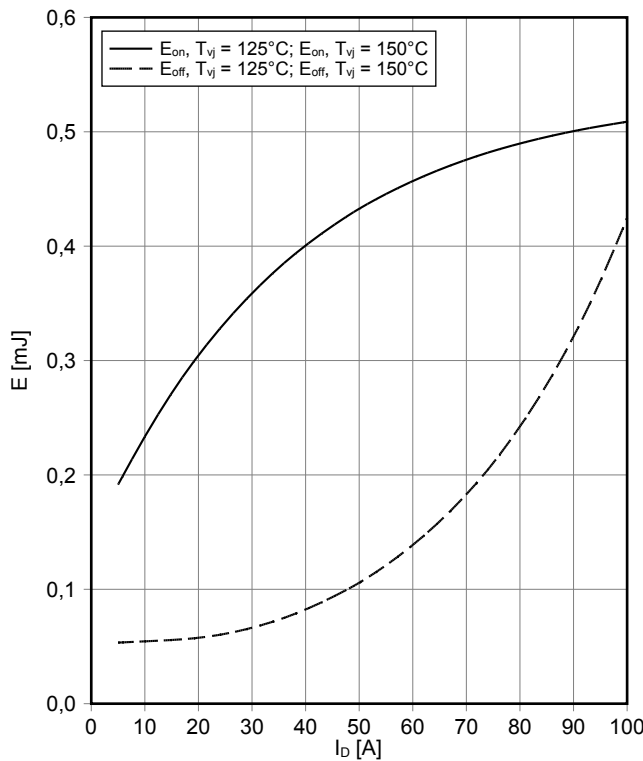

スイッチング損失 MOSFET (Typical)
switching losses MOSFET (typical)

$E_{on} = f(R_G)$, $E_{off} = f(R_G)$
 $V_{GS} = -5\text{ V} / 15\text{ V}$, $I_D = 50\text{ A}$, $V_{DS} = 600\text{ V}$

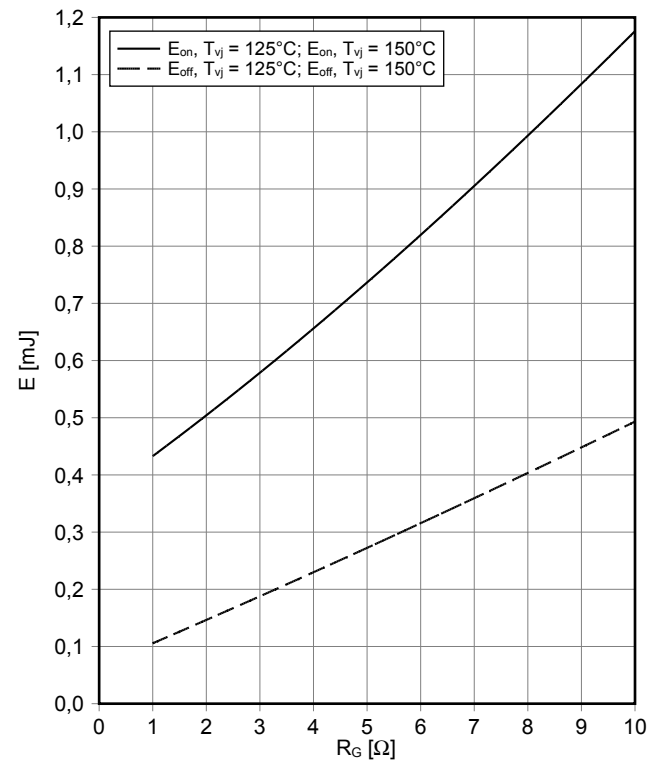

暫定データ Preliminary Data

逆バイアス安全動作領域 MOSFET (RBSOA)
reverse bias safe operating area MOSFET (RBSOA)

$I_D = f(V_{DS})$
 $V_{GS} = -5\text{ V} / 15\text{ V}, R_G = 1\ \Omega, T_{vj} = 150^\circ\text{C}$

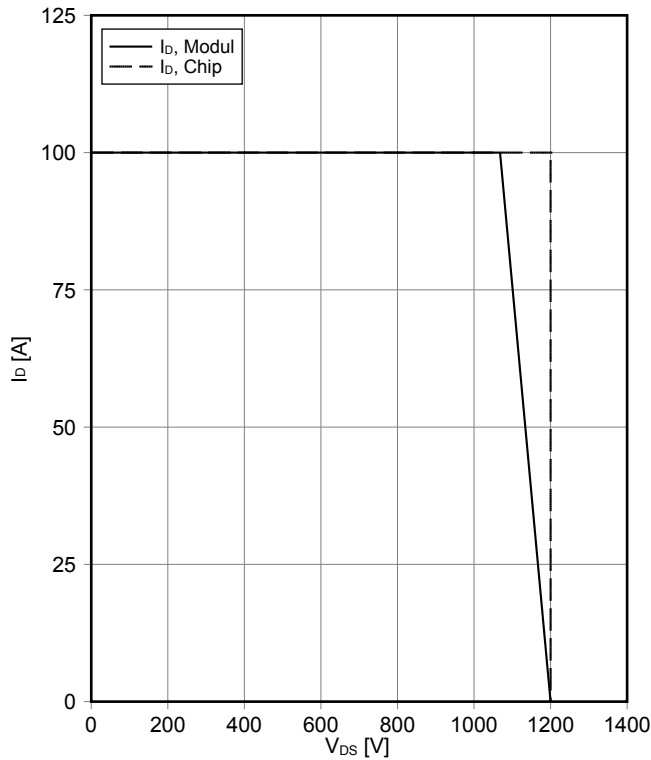

過渡熱インピーダンス MOSFET
transient thermal impedance MOSFET

$Z_{thJH} = f(t)$

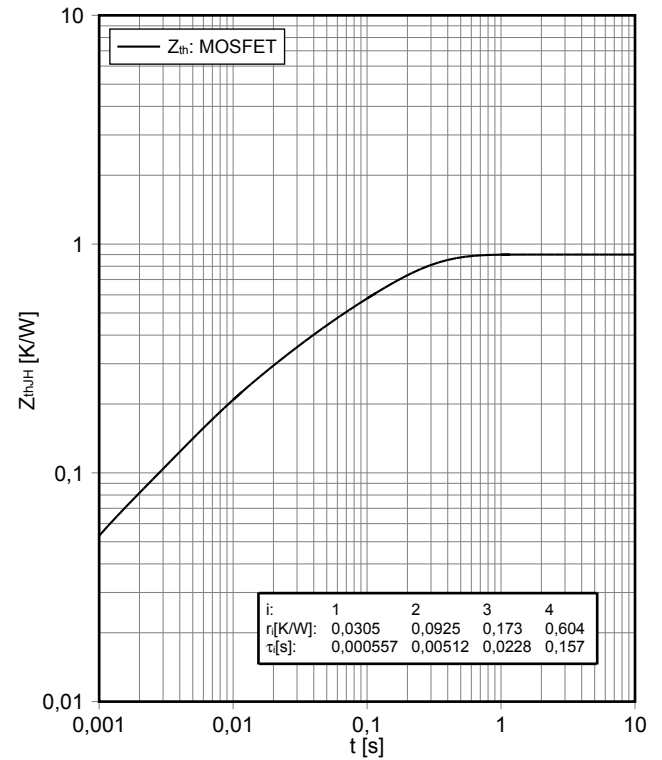

NTC-サーミスタ サーミスタの温度特性
NTC-Thermistor-temperature characteristic (typical)
 $R = f(T)$

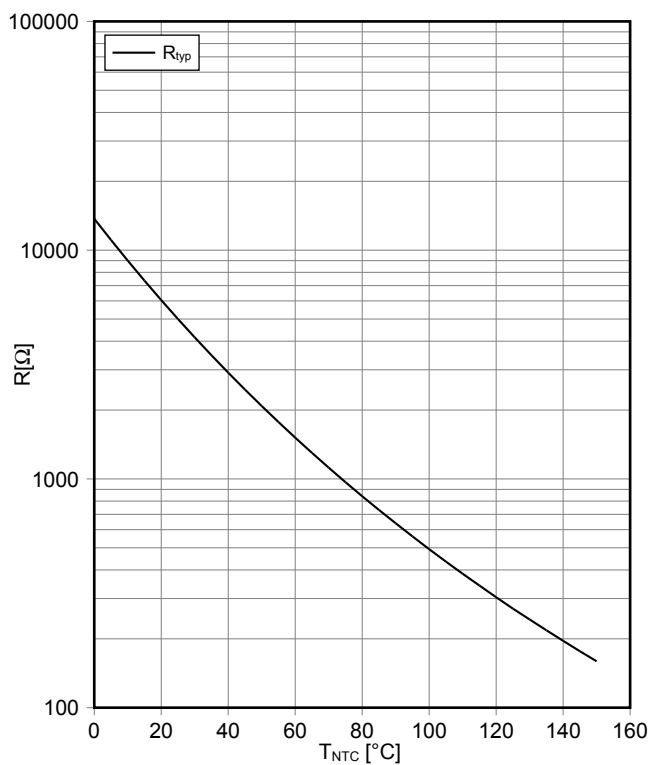

回路図 / Circuit diagram

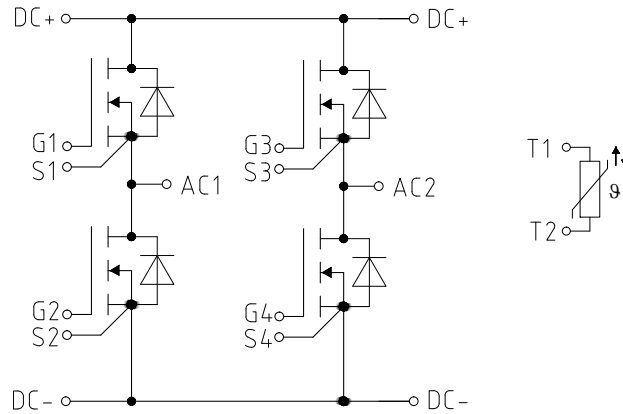

パッケージ概要 / Package outlines

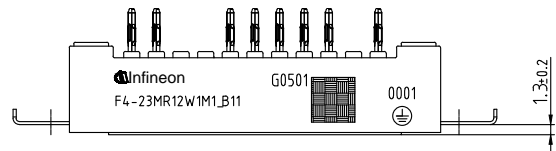
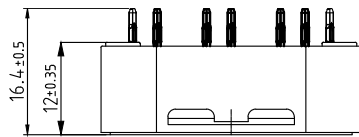

- Pin-Grid 3.2mm
- Tolerance of PCB hole pattern $\oplus \phi 0.1$
- Hole specification for contacts see AN 2009-01
- Diameters of drill ϕ 1.15mm and copper thickness in hole 25-50 μ m

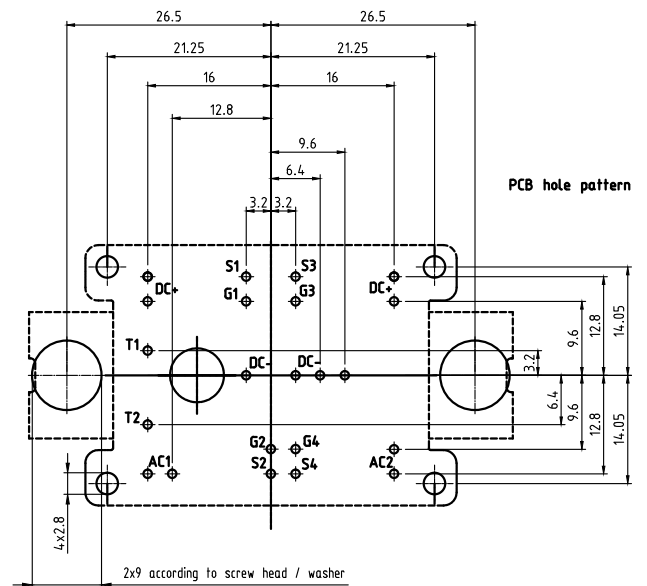
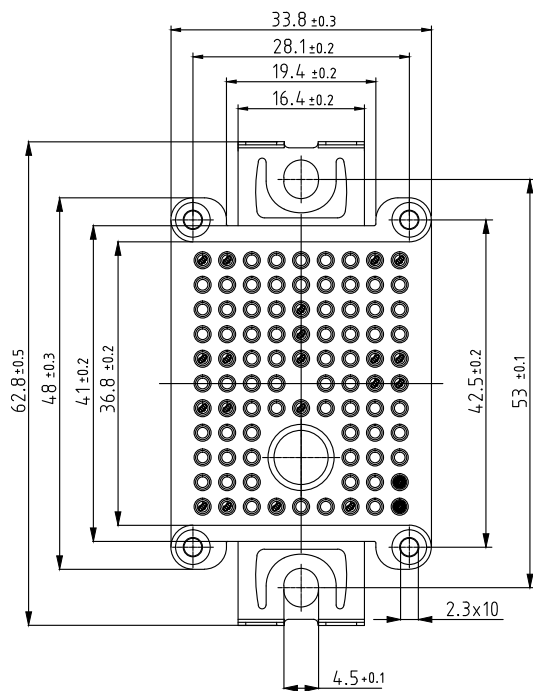

Trademarks

All referenced product or service names and trademarks are the property of their respective owners.

Edition 2019-02-14

Published by
Infineon Technologies AG
81726 München, Germany

© 2019 Infineon Technologies AG.
All Rights Reserved.

Do you have a question about this document?
Email: erratum@infineon.com

重要事項

本文書に記載された情報は、いかなる場合も、条件または特性の保証とみなされるものではありません（「品質の保証」）。本文に記載された一切の事例、手引き、もしくは一般的な価値、および / または本製品の用途に関する一切の情報に関し、インフィニオンテクノロジーズ（以下、「インフィニオン」）はここに、第三者の知的所有権の不侵害の保証を含むがこれに限らず、あらゆる種類の一切の保証および責任を否定いたします。

さらに、本文書に記載された一切の情報は、お客様の用途におけるお客様の製品およびインフィニオン製品の一切の使用に関し、本文書に記載された義務ならびに一切の関連する法的要件、規範、および基準をお客様が遵守することを条件としています。

本文書に含まれるデータは、技術的訓練を受けた従業員のみを対象としています。本製品の対象用途への適合性、およびこれら用途に関連して本文書に記載された製品情報の完全性についての評価は、お客様の技術部門の責任にて実施してください。

本製品、技術、納品条件、および価格についての詳しい情報は、インフィニオンの最寄りの営業所までお問い合わせください（www.infineon.com）。

警告事項

技術的要件に伴い、製品には危険物質が含まれる可能性があります。当該種別の詳細については、インフィニオンの最寄りの営業所までお問い合わせください。

インフィニオンの正式代表者が署名した書面を通じ、インフィニオンによる明示の承認が存在する場合を除き、インフィニオンの製品は、当該製品の障害またはその使用に関する一切の結果が、合理的に人的傷害を招く恐れのある一切の用途に使用することはできないこと予めご了承ください。

IMPORTANT NOTICE

The information given in this document shall in no event be regarded as a guarantee of conditions or characteristics ("Beschaffenheitsgarantie"). With respect to any examples, hints or any typical values stated herein and/or any information regarding the application of the product, Infineon Technologies hereby disclaims any and all warranties and liabilities of any kind, including without limitation warranties of non-infringement of intellectual property rights of any third party.

In addition, any information given in this document is subject to customer's compliance with its obligations stated in this document and any applicable legal requirements, norms and standards concerning customer's products and any use of the product of Infineon Technologies in customer's applications.

The data contained in this document is exclusively intended for technically trained staff. It is the responsibility of customer's technical departments to evaluate the suitability of the product for the intended application and the completeness of the product information given in this document with respect to such application.

For further information on the product, technology, delivery terms and conditions and prices please contact your nearest Infineon Technologies office (www.infineon.com).

WARNINGS

Due to technical requirements products may contain dangerous substances. For information on the types in question please contact your nearest Infineon Technologies office.

Except as otherwise explicitly approved by Infineon Technologies in a written document signed by authorized representatives of Infineon Technologies, Infineon Technologies' products may not be used in any applications where a failure of the product or any consequences of the use thereof can reasonably be expected to result in personal injury.