

# Linear LED driver with BCR430U

## Low-voltage-drop LED driver board up to 100 mA

### About this document

#### Scope and purpose

This document presents an evaluation board design for a linear and low-voltage-drop LED driver based on an Infineon BCR430U controller IC. It is an engineering report on features and performance for a 24 V/100 mA (max. LED current) solution, with explanations covering circuit and layout design.

BCR430U is a linear LED controller IC in a small PG-SOT23-6-1 package regulating the LED current in standalone operation without any external power transistor.

#### Intended audience

This document is intended for design engineers, application engineers and students, for example, who need to design low-cost, highly reliable linear LED drivers for:

- LED strips
- LED displays and channel letters
- Architectural and landscape lighting
- Retail lighting

### Table of contents

<b>About this document</b> .....	<b>1</b>
<b>Table of contents</b> .....	<b>1</b>
<b>1 Introduction</b> .....	<b>2</b>
<b>2 Technical specification</b> .....	<b>2</b>
<b>3 List of product features</b> .....	<b>2</b>
<b>4 Circuit description</b> .....	<b>2</b>
4.1 Circuit diagram.....	2
4.2 Configuration.....	2
<b>5 PCB layout</b> .....	<b>2</b>
<b>6 Bill of Materials (BOM)</b> .....	<b>2</b>
<b>7 Test results</b> .....	<b>2</b>
7.1 Ambient temperature ( $T_A$ ) from -40°C to 125°C.....	2
7.1.1 On-board LEDs as the load .....	2
7.2 More measurements .....	2
<b>Revision history</b> .....	<b>2</b>

### Introduction

## 1 Introduction

This is an engineering report for a 24 V, 100 mA linear LED driver evaluation board. This document contains the technical specification for the LED driver, a description of the main features, and circuit and layout descriptions, as well as the measurement results.

In this application, an Infineon BCR430U is used as an LED driver IC. It regulates the LED current in standalone operation without any external power transistor. The LED current level can be adjusted up to 100 mA by connecting a high ohmic resistor  $R_{set}$  to pin RS. The default LED current is set to 50 mA with an  $R_{set}$  of 12 k $\Omega$ . The voltage drop at the integrated LED driver stage can typically go down to 135 mV (refer to Figure 12), improving the overall system efficiency and providing extra voltage headroom to compensate for tolerances of LED forward voltage or supply voltage. A smart over-temperature protection function reduces the LED current when the junction temperature of BCR430U is very high.

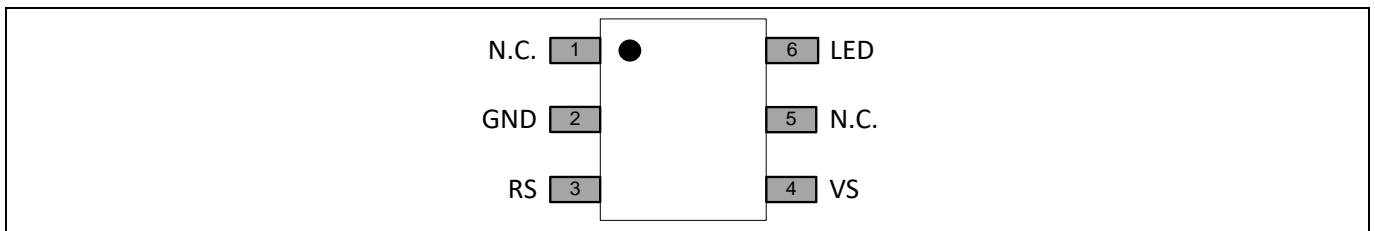

Figure 1 BCR430U pin definition

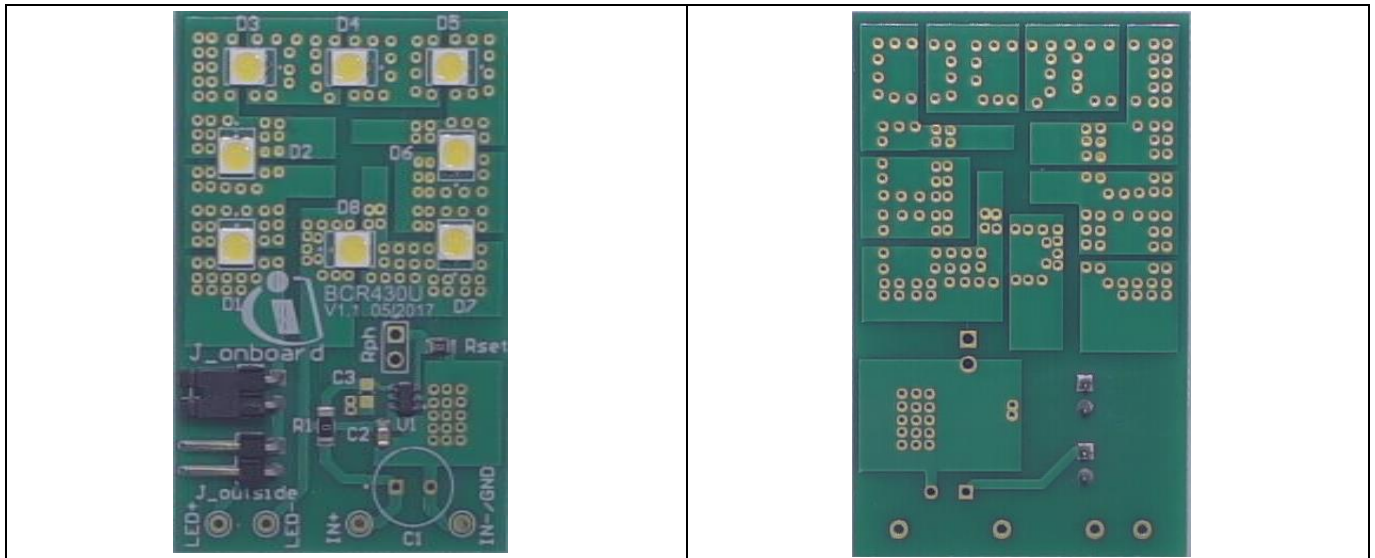

Figure 2 Top and bottom side of the reference design board (55.1 mm x 33.7 mm)

## 2 Technical specification

**Table 1** Technical specification

Input voltage	24 V
Default Rset	12 k $\Omega$
Default LED current	50 mA
Rset range	120 k $\Omega$ to 6.2 k $\Omega$
LED current range	20 mA to 100 mA
On-board LED number	8 LEDs in series
Device dimensions	55.1 mm x 33.7 mm (L x W)

### **3 List of product features**

**Table 2 List of features**

---

Supply voltage from 6 V to 42 V

---

Controls up to 100 mA LED current

---

Typical 135 mV saturation voltage at 50 mA

---

LED current precision  $\pm 10\%$

---

Smart over-temperature protection function vs junction temperature

---

**Circuit description**

**4 Circuit description**

**4.1 Circuit diagram**

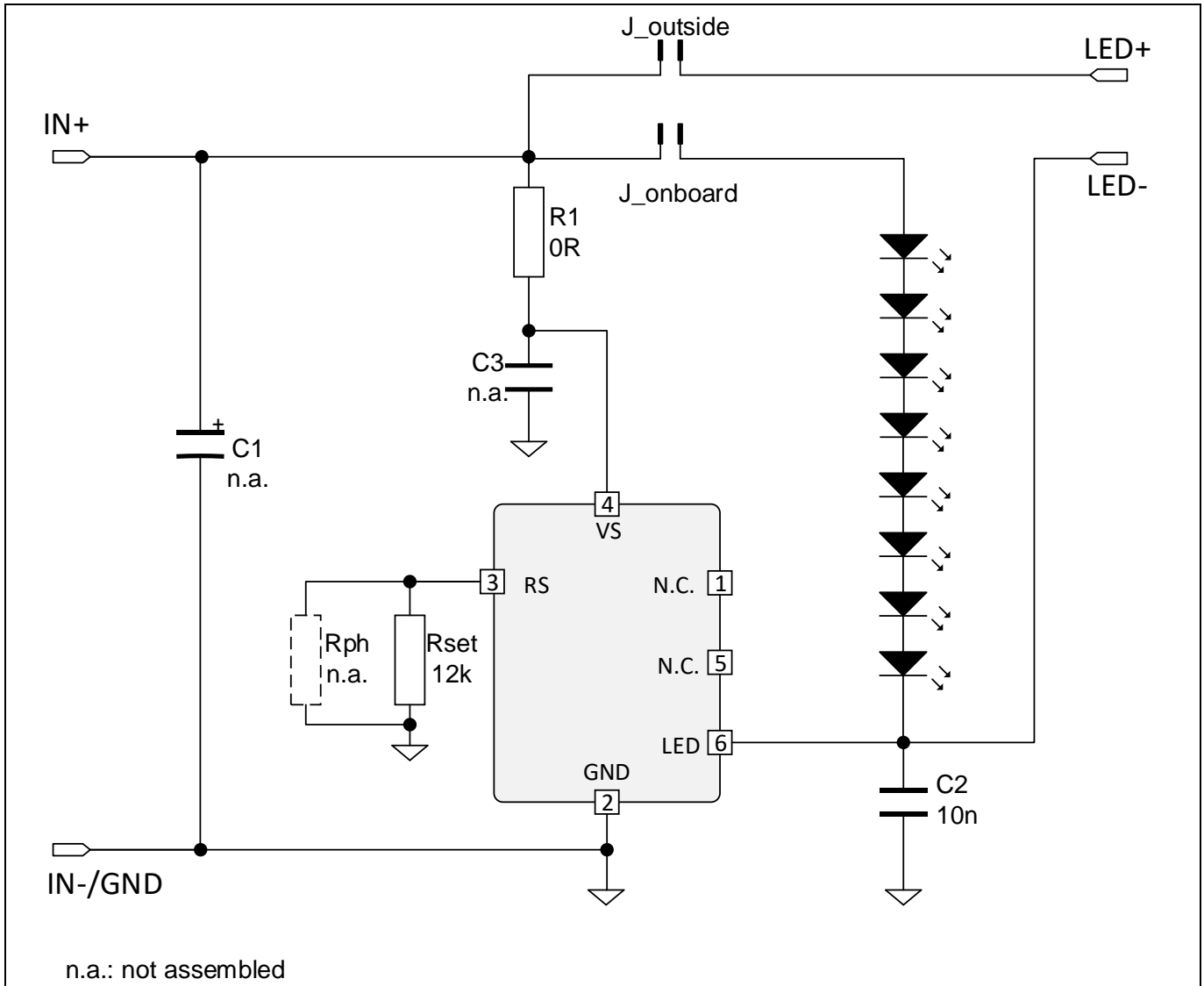

**Figure 3 Schematic diagram of 24 V/50 mA linear LED driver**

C1, C3 and Rph are not assembled.

C1 is a “placeholder” of an electrolytic capacitor. In case of power-supply output voltage ripple, an electrolytic capacitor can be assembled to suppress the ripple.

R1 and C3 can be assembled as high-frequency noise filters if needed for power-supply connection.

A 10 nF bypass capacitor C2 connected between LED pin 6 and GND reduces the risk of oscillation at the LED pin. C2 needs to be placed close to LED pin 6.

R1 can be replaced by a multimeter connection in order to measure the IC current  $I_S$ . Rph is a “placeholder” for a two-pin through-hole footprint of 2.54 mm. It allows for the option of soldering a variable resistor, a header or a through-hole resistor to the board.

#### Circuit description

## 4.2 Configuration

24 V DC source is supplied to ports IN+ and IN-/GND. By default, a jumper is placed on header J\_onboard, so that the on-board LED string is used as the load. If an external LED load is desired, it can be connected to ports LED+ and LED-, and it can be selected as the load by removing the jump from header J\_onboard and placing a jump on header J\_outside.

By default Rset is 12 k $\Omega$ , which configures the LED current to be 50 mA. The LED current level can be adjusted by placing different Rset resistances (please refer to the BCR430U datasheet for more detail).

# Linear LED driver with BCR430U

## Low-voltage-drop LED driver board up to 100 mA

### PCB layout

#### 5 PCB layout

The PCB is double-sided, and is manufactured with the standard 1.5 mm thickness and 1 oz copper. It measures 33.7 mm x 55.1 mm.

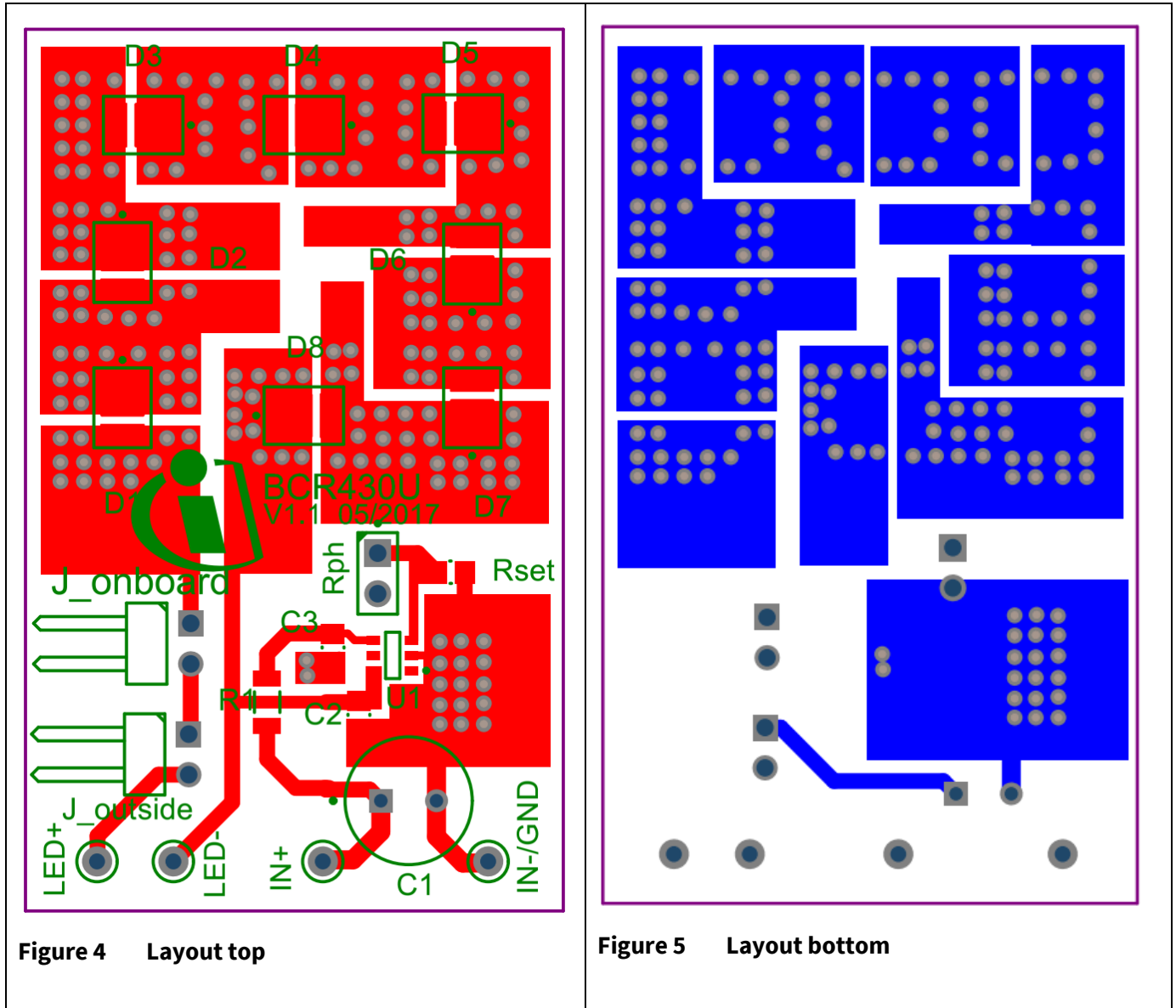

For heat dissipation on BCR430U, it is recommended to connect copper areas that will act as heat spreaders to the GND pin. LEDs also require large copper areas and vias for heat dissipation.

## 6 Bill of Materials (BOM)

**Table 3 BOM**

<b>Component designator</b>	<b>Description</b>	<b>Manufacturer</b>	<b>Manufacturer part number</b>
C2	Ceramic capacitor, 10 nF, 50 V, X7R		Standard capacitor
D1, D2, D3, D4, D5, D6, D7, D8	White LEDs with $V_F$ approx. 2.8 V at 50 mA at $T_j = 25^\circ\text{C}$	Lumileds	MXA9-PW65-H001
J_onboard, J_outside	Through-hole header, 2.54 mm pitch, two pins, right angle	Würth Elektronik	61300211021
J_jump	Jumper sockets, placed on top of J_onboard	3M	969102-0000-DA
R1	Resistor, 0 $\Omega$ , 1%, 1206		Standard resistor
Rset	Resistor, 12 k $\Omega$ , 1%, 0805		Standard resistor
U1	BCR430U, SOT23-6	Infineon	SP001659266



Test results

## 7 Test results

### 7.1 Ambient temperature ( $T_A$ ) from -40°C to 125°C

A smart over-temperature protection is implemented inside BCR430U, which reduces the LED current at high junction temperatures in order to prevent a “thermal runaway”. In this section, voltages at pins RS and LED and LED current are measured at different temperatures.

Test procedure:

1.  $R_{set} = 12\text{ k}\Omega$ .
2. Place the board inside the temperature chamber.
3. Set the chamber temperature to -40°C, and ramp up to 125°C.
4. Measure the voltages on the RS pin ( $V_{RS}$ ) and LED pin ( $V_{LED}$ ), and LED current ( $I_{LED}$ ).

Note: Due to its temperature coefficient, the  $R_{set}$  resistance value changes with respect to temperature.

#### 7.1.1 On-board LEDs as the load

A key advantage of BCR430U is the low driver saturation voltage ( $V_{LED,sat}$ ), which provides extra headroom for tolerances of supply voltage and LED forward voltage and also results in a small power dissipation inside BCR430U. In this measurement input voltage  $V_{IN}$  is reduced to 23.3 V in order to drive the voltage at the LED pin at -40°C, close to the saturation voltage of BCR430U (Figure 7).

Note: The on-board LEDs are not specified for 125°C ambient temperature.

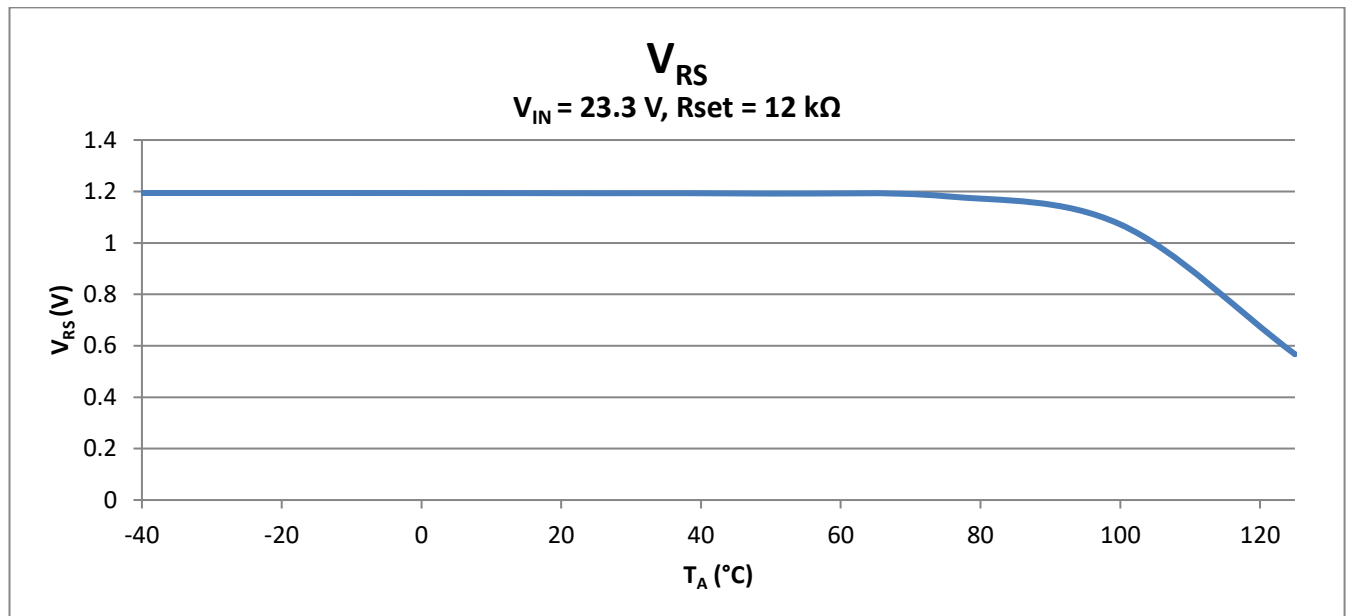

Figure 6 Voltage on the RS pin vs  $T_A$

Test results

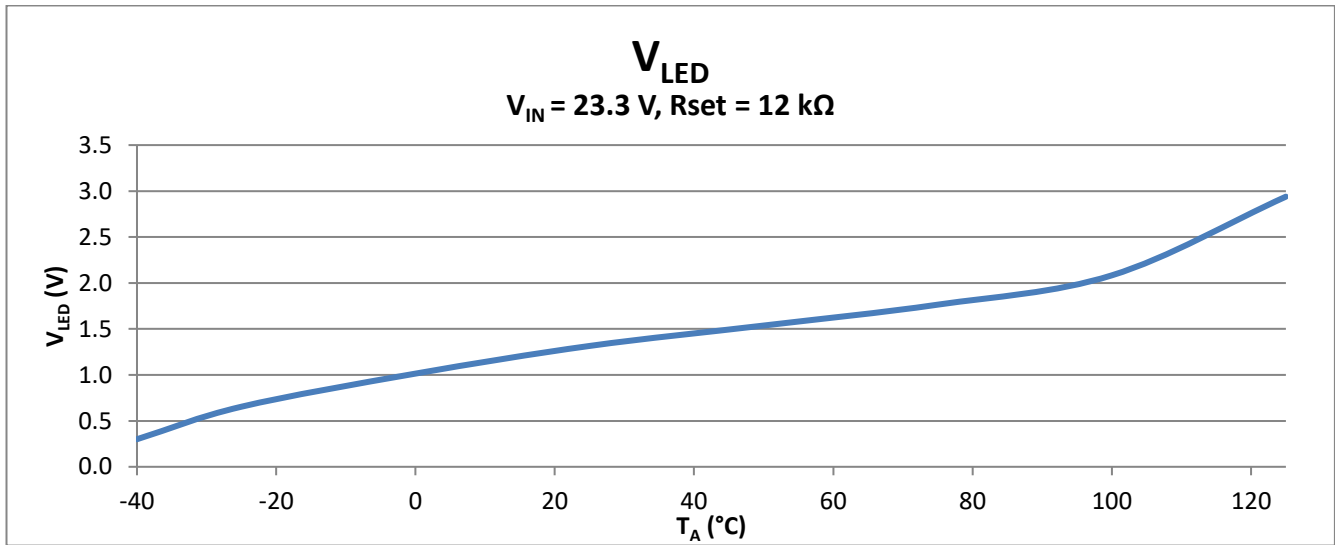

Figure 7 Voltage on the LED pin vs T<sub>A</sub>

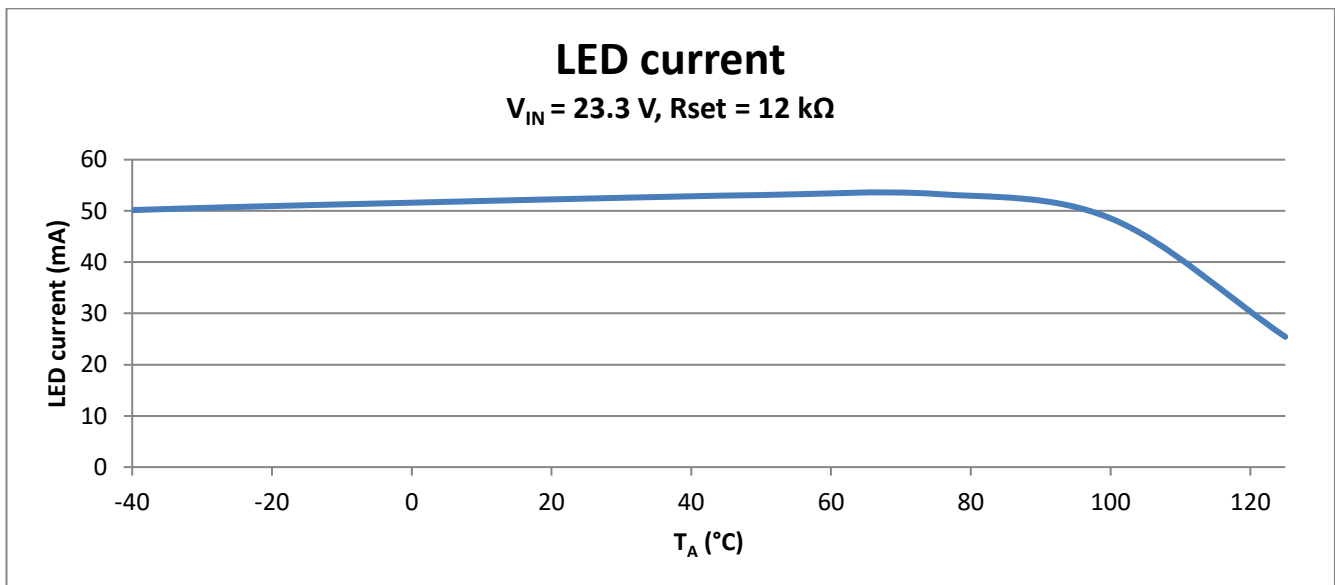

Figure 8 LED current vs T<sub>A</sub>

Test results

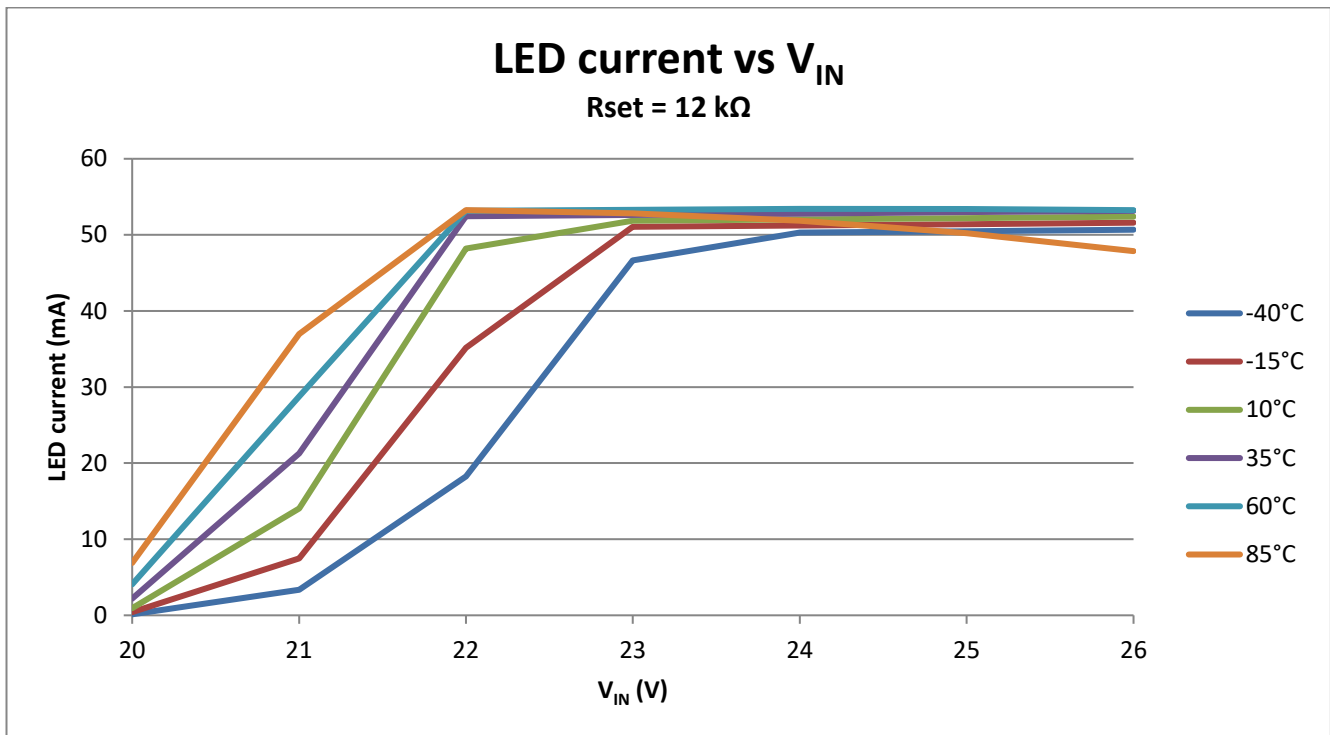

Figure 9 LED current vs  $V_{IN}$  @ different  $T_A$

It can be seen from Figure 8 and Figure 9 that when the ambient temperature rises above 75°C, the over-temperature protection function starts, reducing the LED current.

### 7.2 More measurements

The following measurements are done at room temperature (unless otherwise specified). The data is recorded when the board runs for 30 minutes and reaches thermal stability, except Figure 10.

Figure 10 shows the LED current measured at 0 (i.e. immediately LEDs are on), 10, 20 and 30 minutes. In the beginning the IC is at room temperature. Over time the IC temperature increases until it reaches thermal stability. Due to the positive temperature coefficient of the LED current below activation of the over-temperature protection (refer to Figure 8), the LED current increases slightly until the IC reaches thermal stability.

Test results

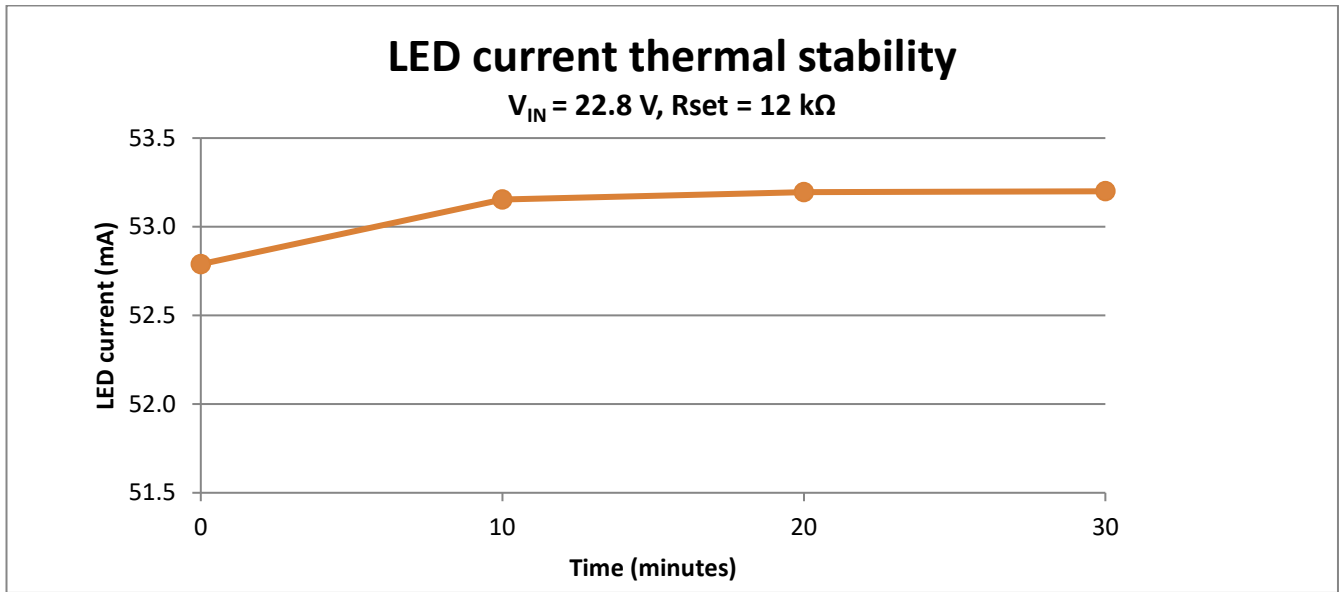

Figure 10 LED current vs running time

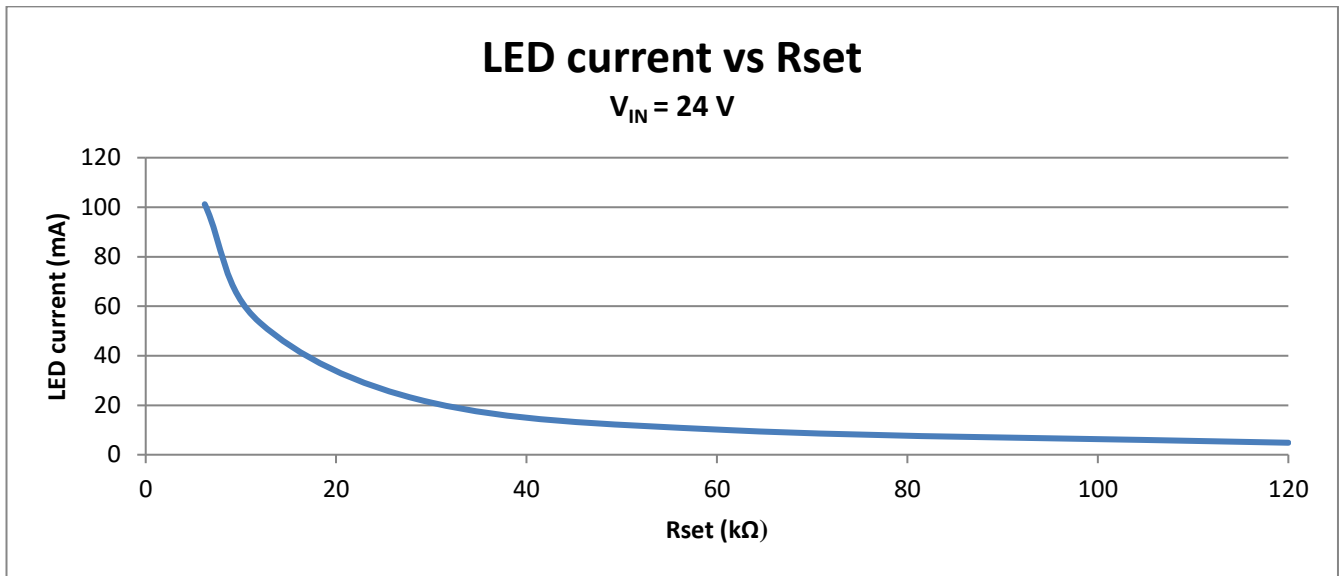

Figure 11 LED current dependency on Rset

Test results

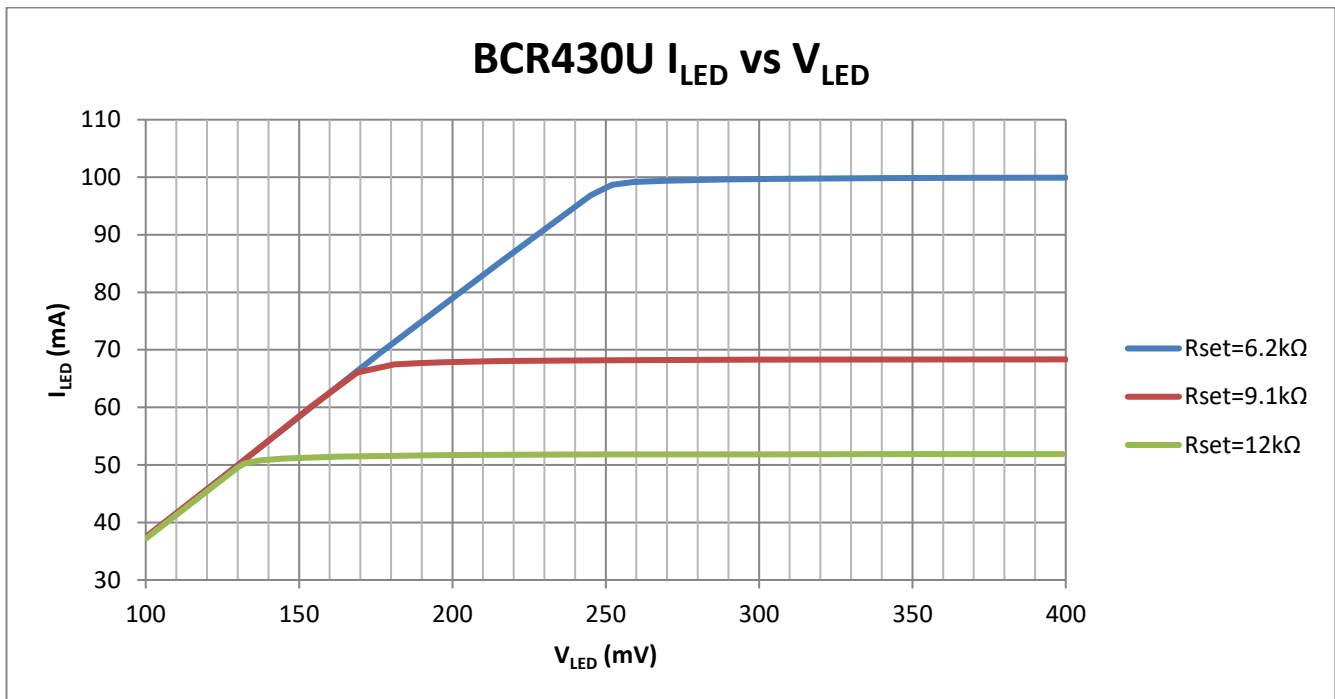

Figure 12 LED current vs voltage on LED pin (pin 6)

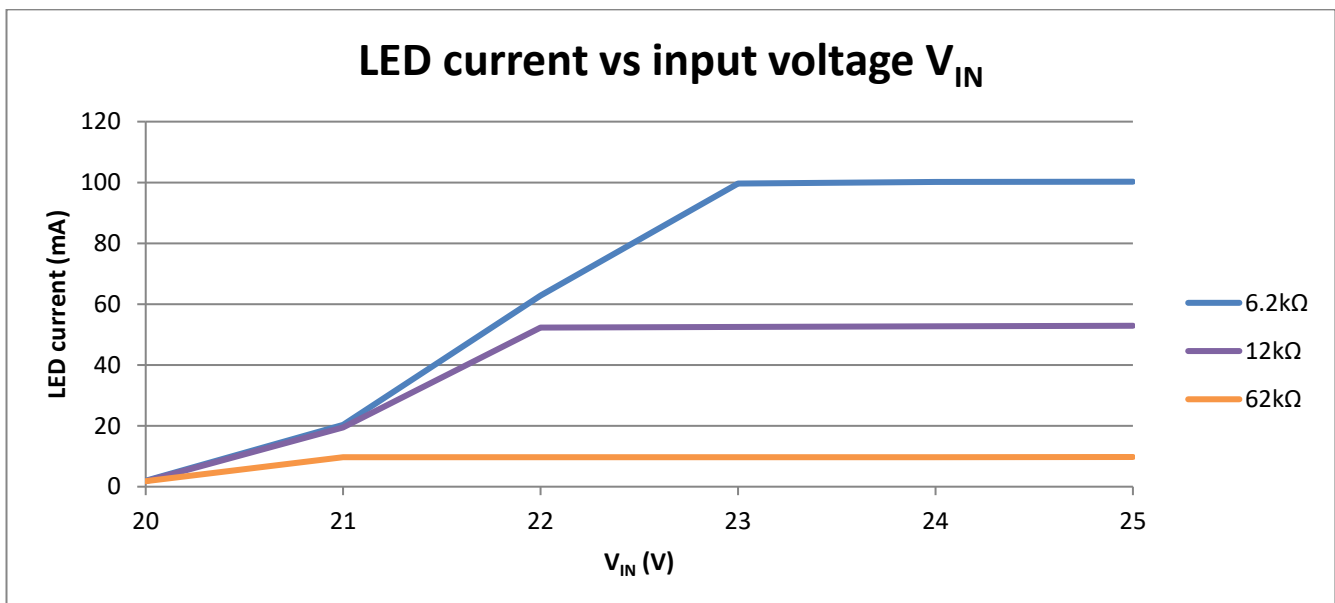

Figure 13 LED current vs input voltage (at room temperature)

Figure 12 shows the relationship between LED current  $I_{LED}$  and the voltage  $V_{LED}$  at pin 6 for three different values of resistor  $R_{set}$ .

Figure 13 shows the relationship between LED current  $I_{LED}$  and the evaluation board input voltage  $V_{IN}$  for three different values of resistor  $R_{set}$ . Due to the increase in the LED forward voltage with increasing LED current the  $V_{IN}$  voltage sweep is wider than in Figure 12, until a constant LED current is reached.

Test results

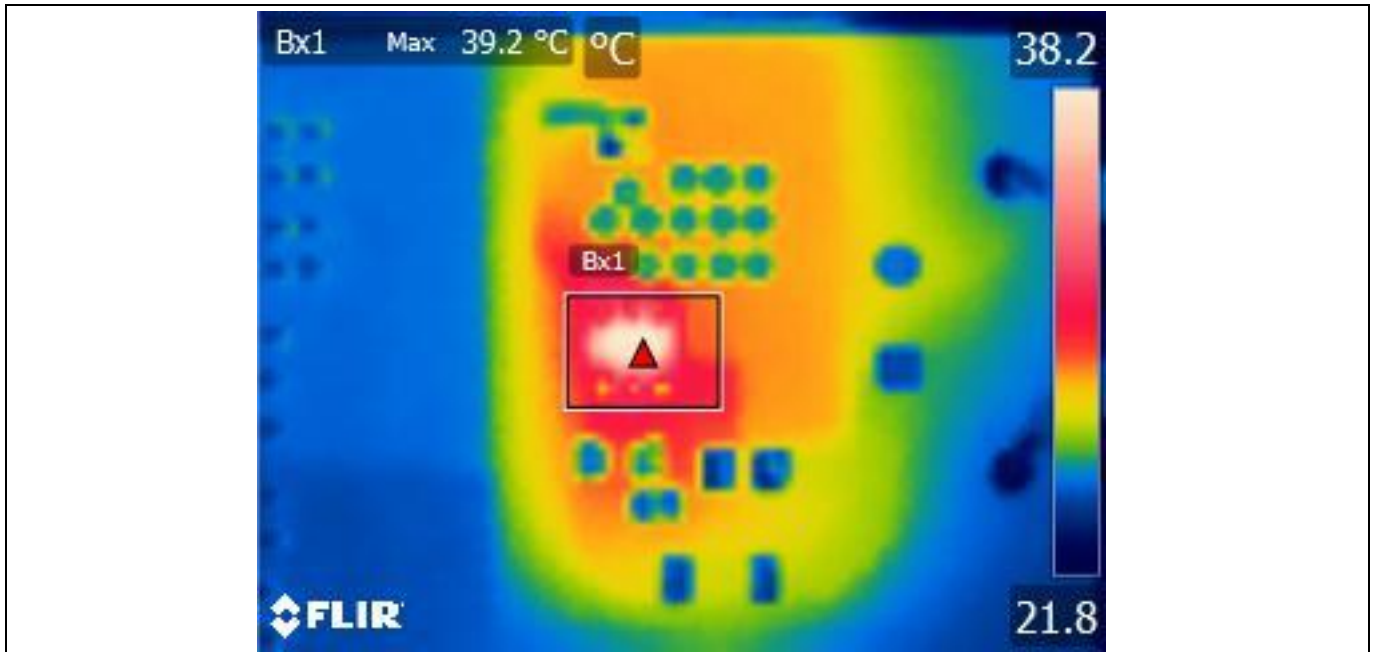

Figure 14 Thermal photo ( $V_{IN} = 24\text{ V}$ ,  $R_{set} = 9.1\text{ k}\Omega$ ,  $I_{LED} = 68\text{ mA}$ ,  $T_A = 25^\circ\text{C}$ )

Figure 14 shows the thermal photo of the board (portion). BCR430U is located in the rectangle, with a case temperature of  $39.2^\circ\text{C}$ .

**Revision history**

**Revision history**

Major changes since the last revision

<b>Revision</b>	<b>Page or reference</b>	<b>Description of change</b>
V1.1	Page 8	ESD protection chapter added
V1.2	Page 8	ESD protection chapter deleted

#### **Trademarks**

All referenced product or service names and trademarks are the property of their respective owners.

**Edition 2020-10-14**

**Published by**

**Infineon Technologies AG**

**81726 Munich, Germany**

**© 2020 Infineon Technologies AG.**

**All Rights Reserved.**

**Do you have a question about this document?**

**Email: [erratum@infineon.com](mailto:erratum@infineon.com)**

**Document reference**

**ER\_201704\_PL39\_008**

#### **IMPORTANT NOTICE**

The information contained in this application note is given as a hint for the implementation of the product only and shall in no event be regarded as a description or warranty of a certain functionality, condition or quality of the product. Before implementation of the product, the recipient of this application note must verify any function and other technical information given herein in the real application. Infineon Technologies hereby disclaims any and all warranties and liabilities of any kind (including without limitation warranties of non-infringement of intellectual property rights of any third party) with respect to any and all information given in this application note.

The data contained in this document is exclusively intended for technically trained staff. It is the responsibility of customer's technical departments to evaluate the suitability of the product for the intended application and the completeness of the product information given in this document with respect to such application.

For further information on the product, technology, delivery terms and conditions and prices please contact your nearest Infineon Technologies office ([www.infineon.com](http://www.infineon.com)).

#### **WARNINGS**

Due to technical requirements products may contain dangerous substances. For information on the types in question please contact your nearest Infineon Technologies office.

Except as otherwise explicitly approved by Infineon Technologies in a written document signed by authorized representatives of Infineon Technologies, Infineon Technologies' products may not be used in any applications where a failure of the product or any consequences of the use thereof can reasonably be expected to result in personal injury.