

TVS Diodes

Transient Voltage Suppressor Diodes

ESD5V5U5ULC

Ultra-low Capacitance ESD / Transient / Surge Protection Array

ESD5V5U5ULC

Data Sheet

Revision 1.4, 2016-06-27
Final

Edition 2016-06-27

Published by

Infineon Technologies AG

81726 Munich, Germany

© 2016 Infineon Technologies AG

All Rights Reserved.

Legal Disclaimer

The information given in this document shall in no event be regarded as a guarantee of conditions or characteristics. With respect to any examples or hints given herein, any typical values stated herein and/or any information regarding the application of the device, Infineon Technologies hereby disclaims any and all warranties and liabilities of any kind, including without limitation, warranties of non-infringement of intellectual property rights of any third party.

Information

For further information on technology, delivery terms and conditions and prices, please contact the nearest Infineon Technologies Office (www.infineon.com)

Warnings

Due to technical requirements, components may contain dangerous substances. For information on the types in question, please contact the nearest Infineon Technologies Office.

Infineon Technologies components may be used in life-support devices or systems only with the express written approval of Infineon Technologies, if a failure of such components can reasonably be expected to cause the failure of that life-support device or system or to affect the safety or effectiveness of that device or system. Life support devices or systems are intended to be implanted in the human body or to support and/or maintain and sustain and/or protect human life. If they fail, it is reasonable to assume that the health of the user or other persons may be endangered.

1 Ultra-low Capacitance ESD / Transient / Surge Protection Array

1.1 Features

- ESD / Transient protection of high speed data lines exceeding
 - IEC61000-4-2 (ESD): ± 25 kV (air / contact)
 - IEC61000-4-4 (EFT): ± 2.5 kV / ± 50 A (5/50 ns)
 - IEC61000-4-5 (surge): ± 6 A (8/20 μ s)
- Maximum working voltage: $V_{RWM} = 5.5$ V
- Extremely low capacitance $C_L = 0.45$ pF I/O to GND (typical)
- Very low dynamic resistance: R_{DYN} I/O to GND = 0.2Ω (typical)
- Very low reverse clamping voltage: $V_{CL} = 9$ V (typical) at $I_{PP} = 16$ A
- Protection of V_{BUS} with one line freely selectable
- Pb-free (RoHS compliant) package



1.2 Application Examples

- Protection of all I/O and V_{BUS} lines in dual USB2.0 ports
- 10/100/1000 Ethernet
- DVI, HDMI, FireWire

1.3 Product Description

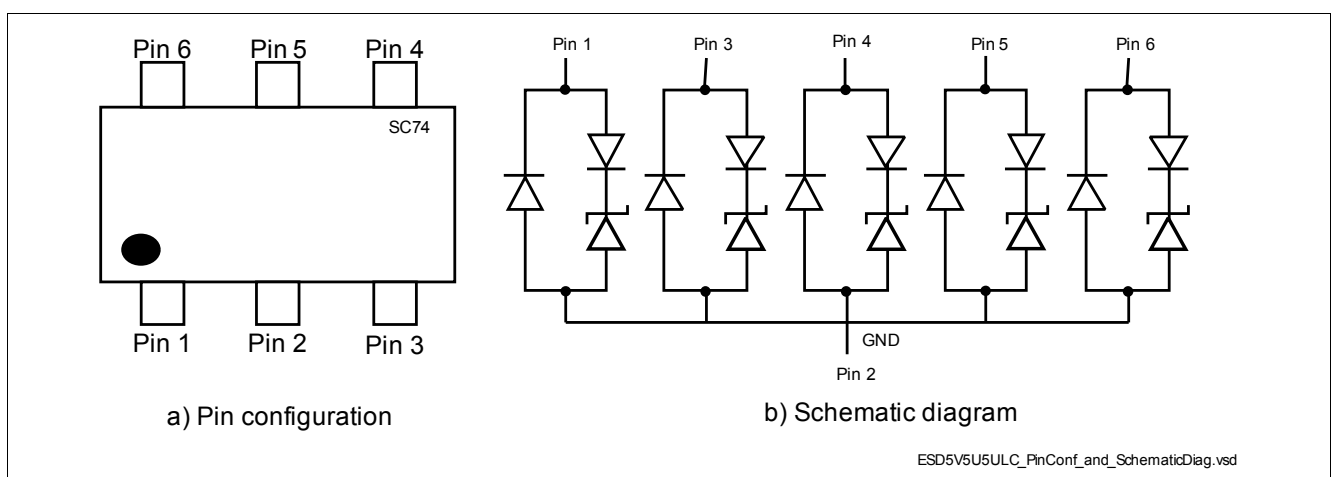

Figure 1 Pin Configuration and Schematic Diagram

Table 1 Ordering Information

Type	Package	Configuration	Marking code
ESD5V5U5ULC	SC74	5 lines, uni-directional	20

2 Characteristics

Table 2 Maximum Rating at $T_A = 25\text{ °C}$, unless otherwise specified

Parameter	Symbol	Values			Unit
		Min.	Typ.	Max.	
ESD contact discharge ¹⁾	V_{ESD}	-25	–	25	kV
Peak pulse current ($t_p = 8/20\ \mu\text{s}$) ²⁾	I_{PP}	-6	–	6	A
Operating temperature range	T_{OP}	-40	–	125	°C
Storage temperature	T_{stg}	-65	–	150	°C

1) V_{ESD} according to IEC61000-4-2

2) I_{PP} according to IEC61000-4-5

Attention: Stresses above the max. values listed here may cause permanent damage to the device. Exposure to absolute maximum rating conditions for extended periods may affect device reliability. Maximum ratings are absolute ratings; exceeding only one of these values may cause irreversible damage to the integrated circuit.

2.1 Electrical Characteristics at $T_A = 25\text{ °C}$, unless otherwise specified

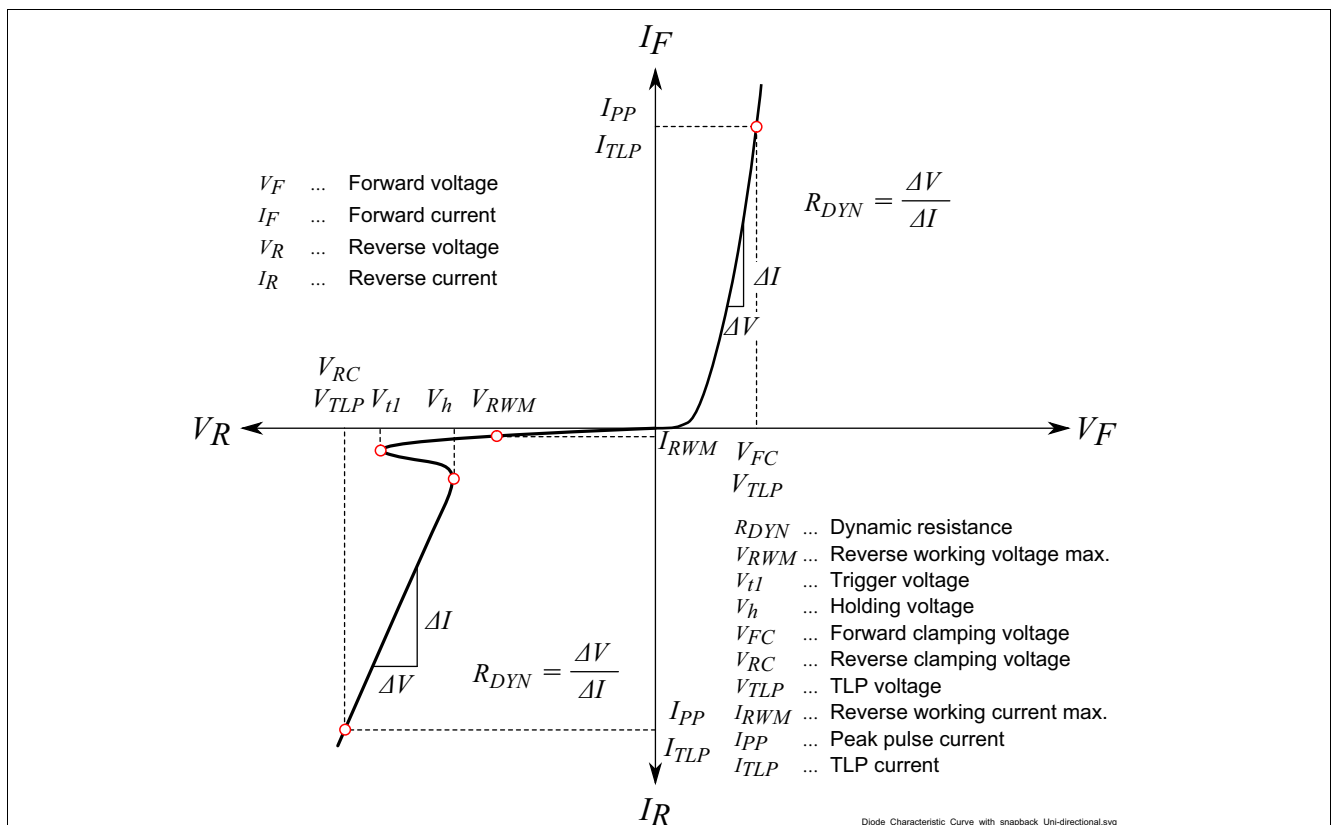

Figure 2 Definitions of Electrical Characteristics[1]

Characteristics
Table 3 DC Characteristics at $T_A = 25\text{ }^\circ\text{C}$, unless otherwise specified

Parameter	Symbol	Values			Unit	Note / Test Condition
		Min.	Typ.	Max.		
Reverse working voltage	V_{RWM}	–	–	5.5	V	I/O to GND
Reverse current	I_R	–	<1	100	nA	$V_R = 5.5\text{ V}$, I/O to GND

Table 4 RF Characteristics at $T_A = 25\text{ }^\circ\text{C}$, unless otherwise specified

Parameter	Symbol	Values			Unit	Note / Test Condition
		Min.	Typ.	Max.		
Line capacitance	C_L	–	0.45	1	pF	$V_R = 0\text{ V}$, $f = 1\text{ MHz}$, I/O to GND
		–	0.23	0.5	pF	$V_R = 0\text{ V}$, $f = 1\text{ MHz}$, I/O to I/O
Line capacitance	C_L	–	0.25	–	pF	$V_R = 0\text{ V}$, $f = 825\text{ MHz}$, I/O to GND
		–	0.13	–	pF	$V_R = 0\text{ V}$, $f = 825\text{ MHz}$, I/O to I/O
Capacitance variation between I/O and GND	$\Delta C_{i/o-GND}$	–	0.02	–	pF	$V_R = 0\text{ V}$, $f = 1\text{ MHz}$, I/O to GND
Capacitance variation between I/O	$\Delta C_{i/o-i/o}$	–	0.01	–	pF	$V_R = 0\text{ V}$, $f = 1\text{ MHz}$, I/O to I/O

Table 5 ESD Characteristics at $T_A = 25\text{ }^\circ\text{C}$, unless otherwise specified

Parameter	Symbol	Values			Unit	Note / Test Condition
		Min.	Typ.	Max.		
Reverse clamping voltage ¹⁾	V_{CL}	–	9	–	V	$I_{PP} = 1\text{ A}$, $t_p = 8/20\text{ }\mu\text{s}$, I/O pin to GND
		–	12	–	V	$I_{PP} = 3\text{ A}$, $t_p = 8/20\text{ }\mu\text{s}$, I/O pin to GND
Reverse clamping voltage ²⁾ [2]	V_{CL}	–	8.9	–	V	$I_{PP} = 16\text{ A}$, $t_p = 100\text{ ns}$, I/O pin to GND
		–	11.5	–	V	$I_{PP} = 30\text{ A}$, $t_p = 100\text{ ns}$, I/O pin to GND
Forward clamping voltage ¹⁾	V_{FC}	–	1.75	–	V	$I_{PP} = 1\text{ A}$, $t_p = 8/20\text{ }\mu\text{s}$, GND pin to I/O
		–	2.5	–	V	$I_{PP} = 3\text{ A}$, $t_p = 8/20\text{ }\mu\text{s}$, GND pin to I/O
Forward clamping voltage ²⁾ [2]	V_{FC}	–	5.4	–	V	$I_{PP} = 16\text{ A}$, $t_p = 100\text{ ns}$, GND pin to I/O
		–	9.2	–	V	$I_{PP} = 30\text{ A}$, $t_p = 100\text{ ns}$, GND pin to I/O
Dynamic resistance I/O to GND ²⁾ [2]	$R_{DYN, I/O}$ to GND	–	0.2	–	Ω	
Dynamic resistance GND to I/O ²⁾ [2]	$R_{DYN,}$ GND to I/O	–	0.3	–	Ω	

1) I_{PP} according to IEC61000-4-5

2) Please refer to Application Note AN210[2]. TLP parameter: $Z_0 = 50\text{ }\Omega$, $t_p = 100\text{ ns}$, $t_r = 300\text{ ps}$, averaging window: $t_1 = 30\text{ ns}$ to $t_2 = 60\text{ ns}$, extraction of dynamic resistance using least squares fit of TLP characteristic between $I_{PP1} = 10\text{ A}$ and $I_{PP2} = 40\text{ A}$.

2.2 Typical Characteristics at $T_A = 25\text{ }^\circ\text{C}$, unless otherwise specified

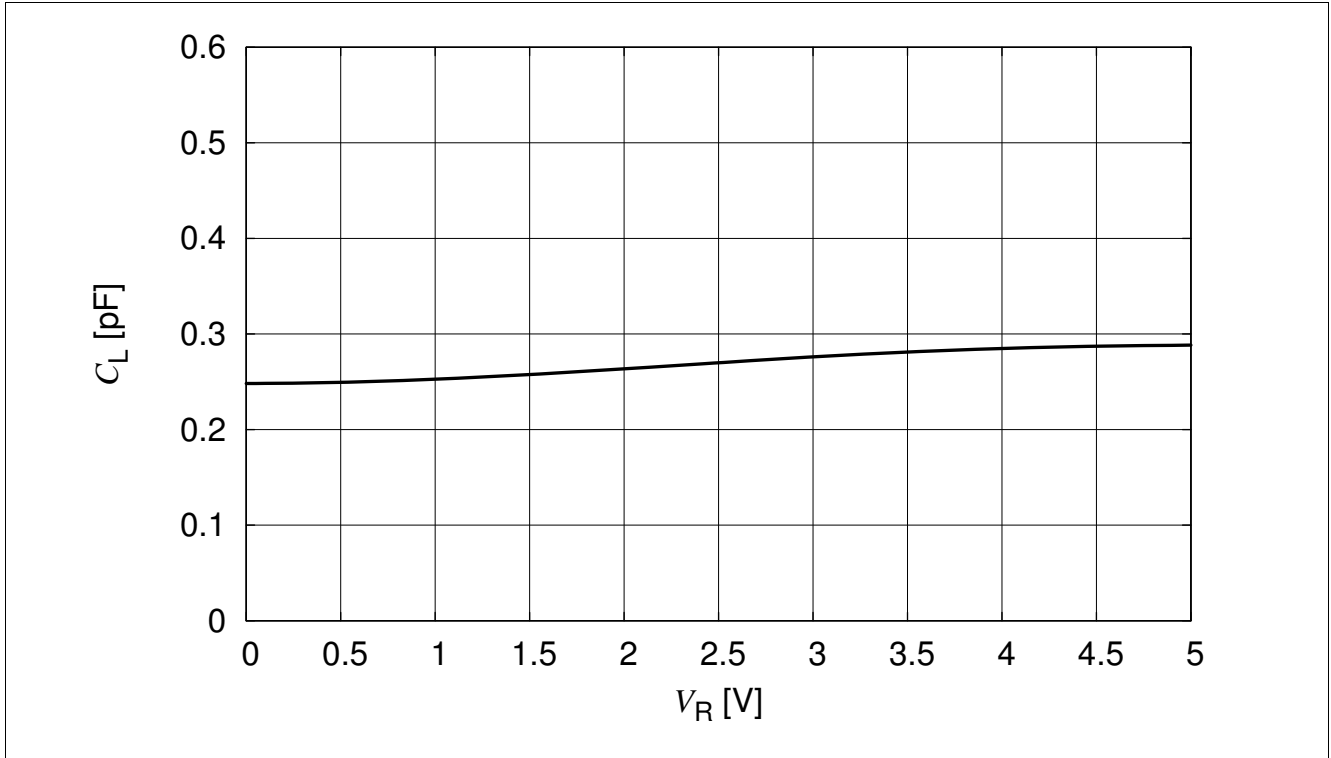

Figure 3 Line capacitance $C_L = f(V_R)$ at $f = 825\text{ MHz}$

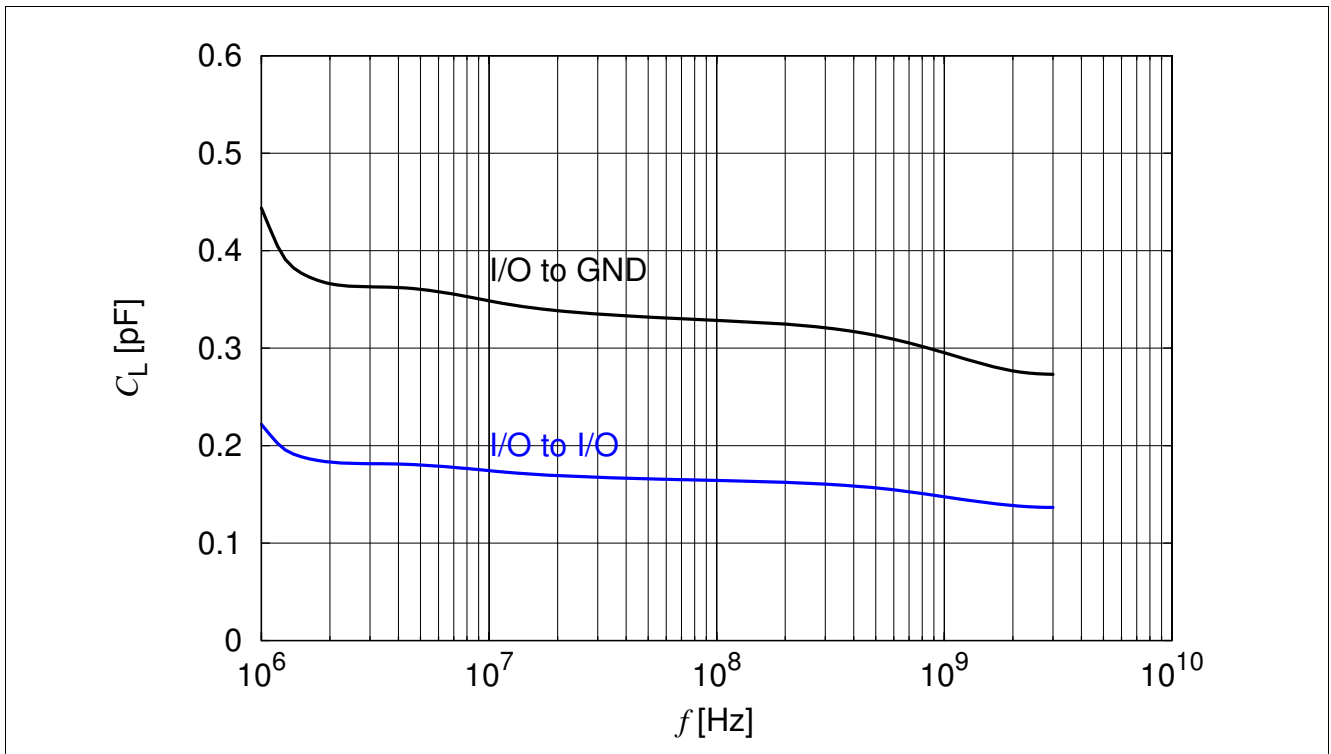

Figure 4 Line capacitance $C_L = f(f)$, $V_R = 0\text{ V}$

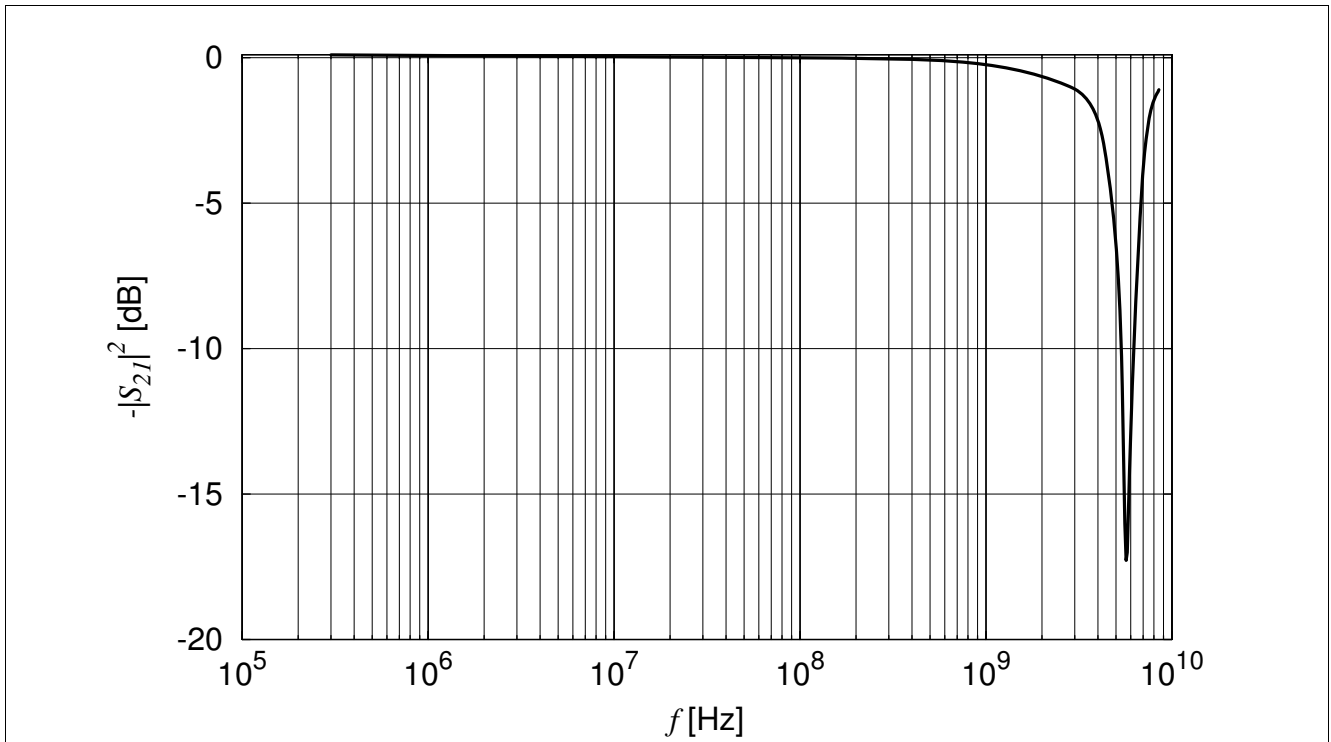

Figure 5 Insertion loss $I_L = f(f)$, $V_R = 0$ V

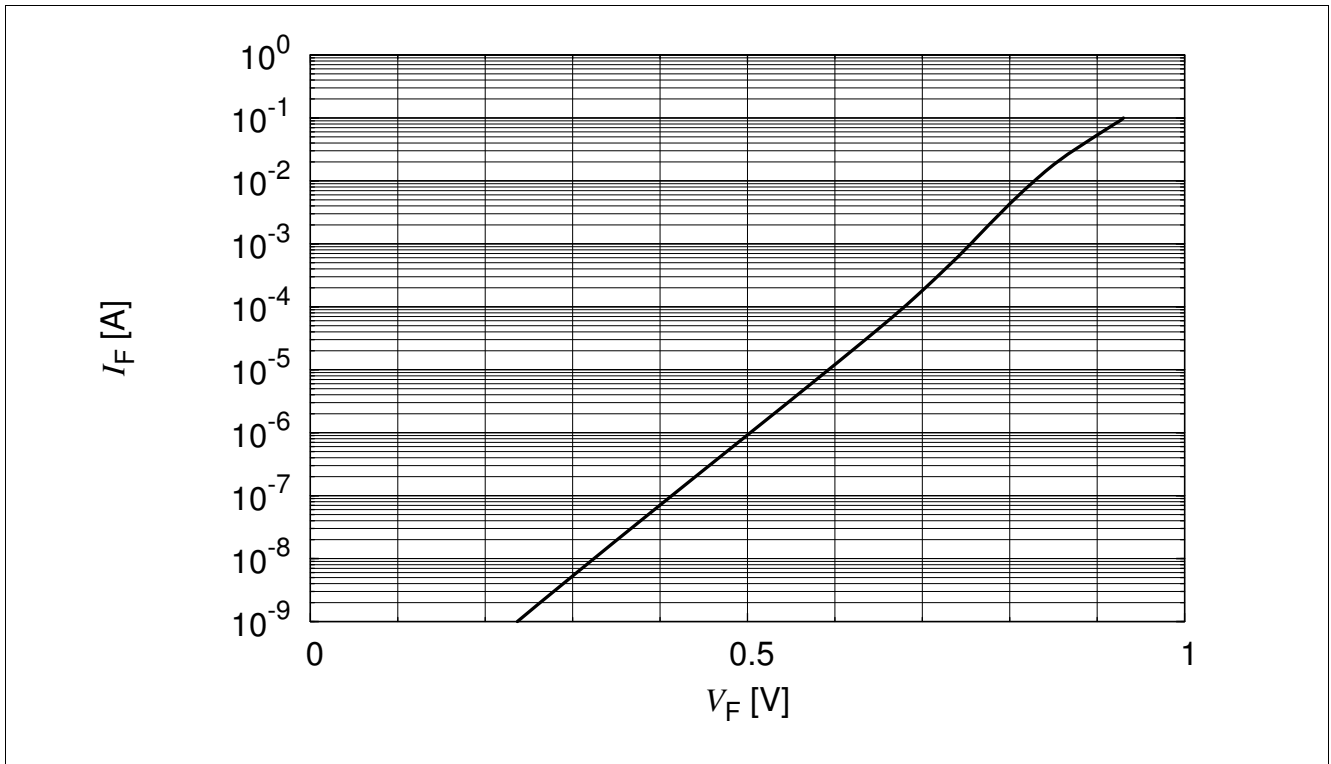

Figure 6 Forward characteristic, $I_F = f(V_F)$, current forced

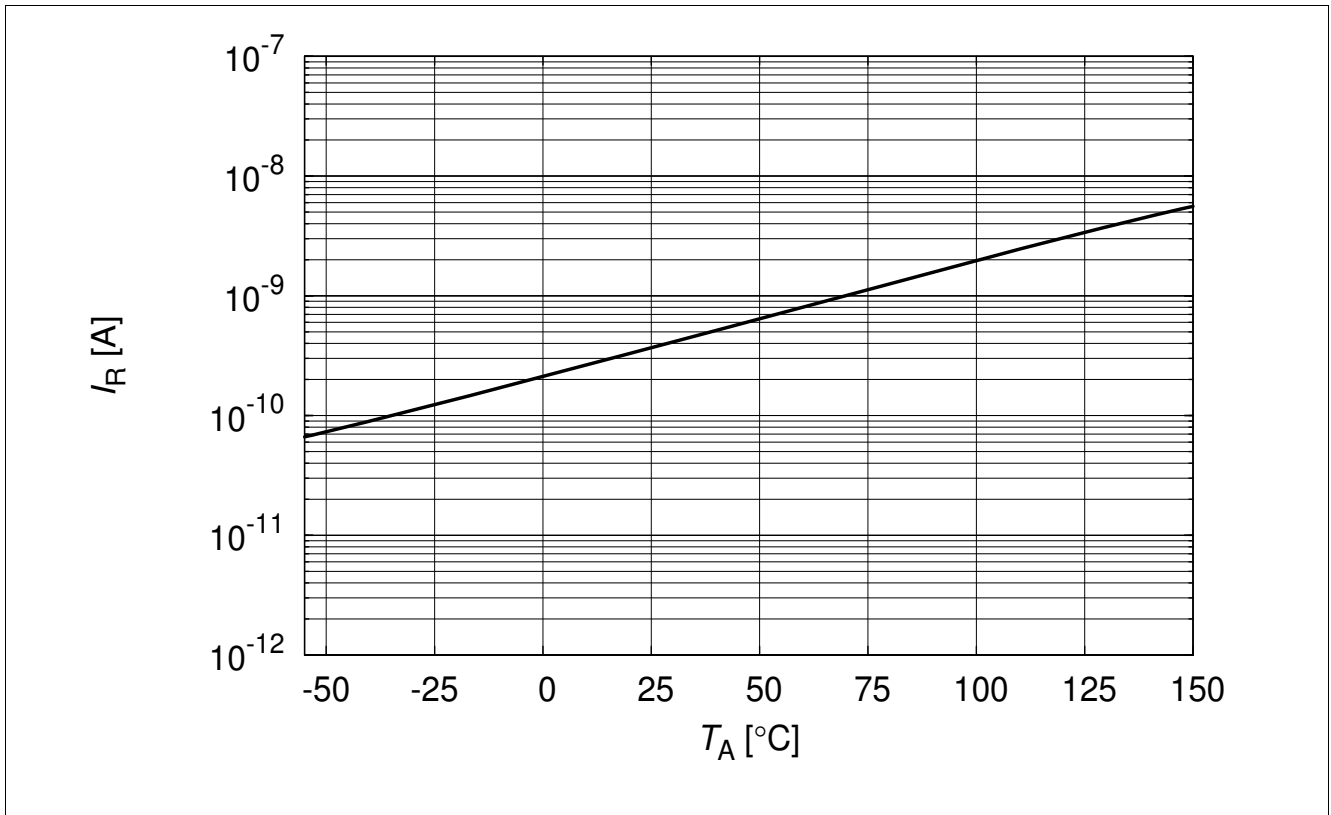

Figure 7 Reverse current $I_R = f(T_A)$, $V_R = 5.5$ V (typical)

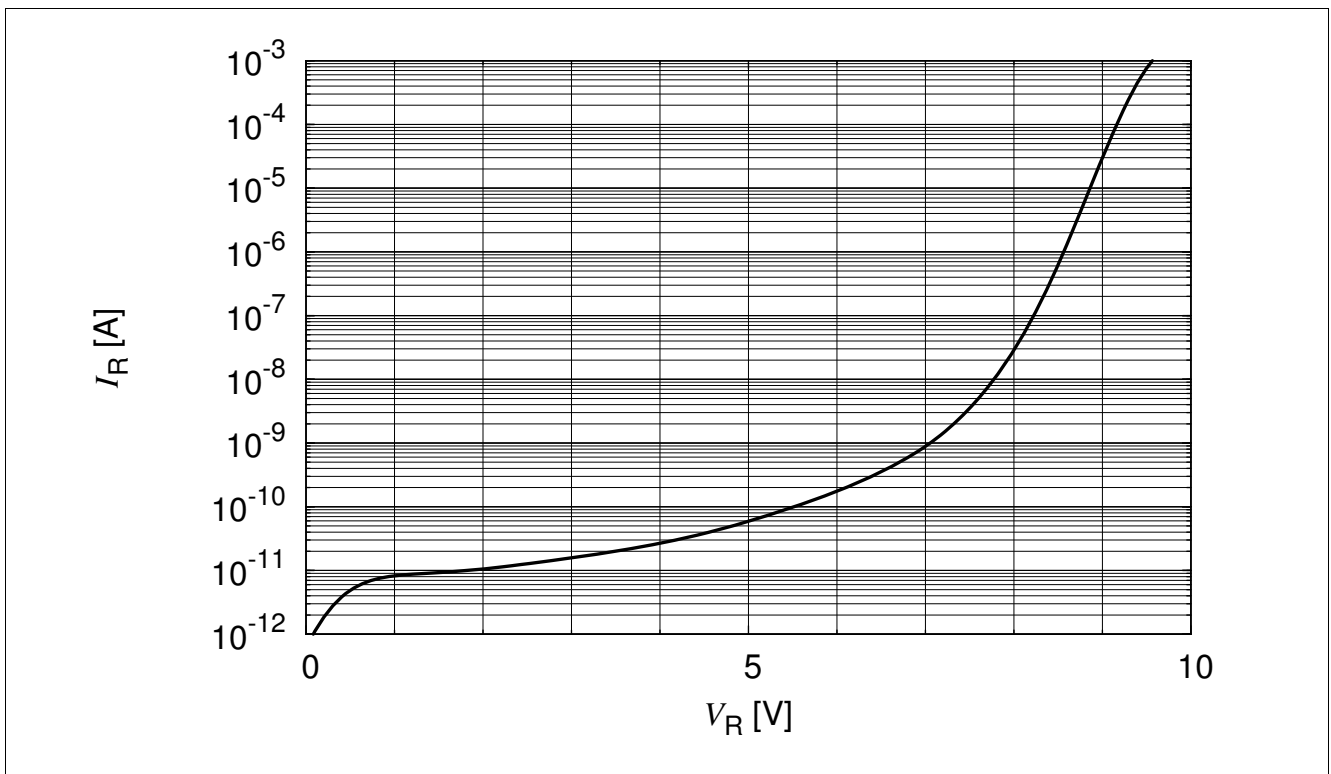

Figure 8 Reverse characteristic, $I_R = (V_R)$, voltage forced

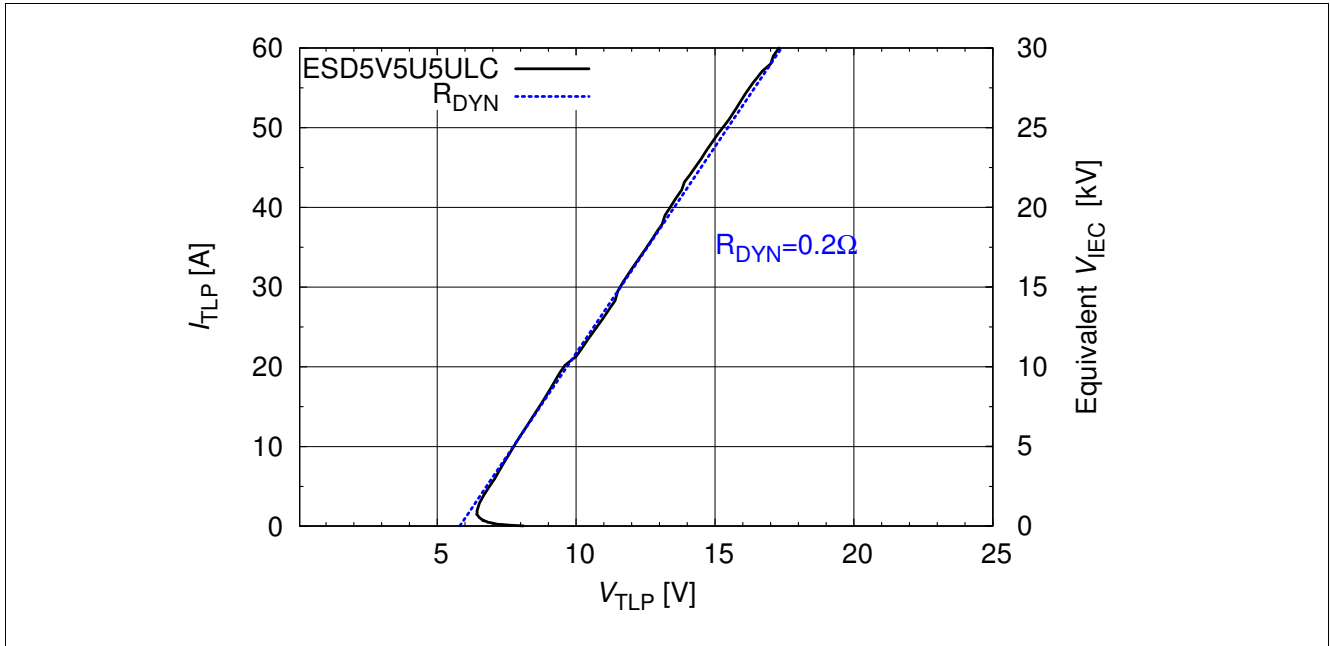

Figure 9 TLP characteristic I/O to GND ^{Note: [2]}

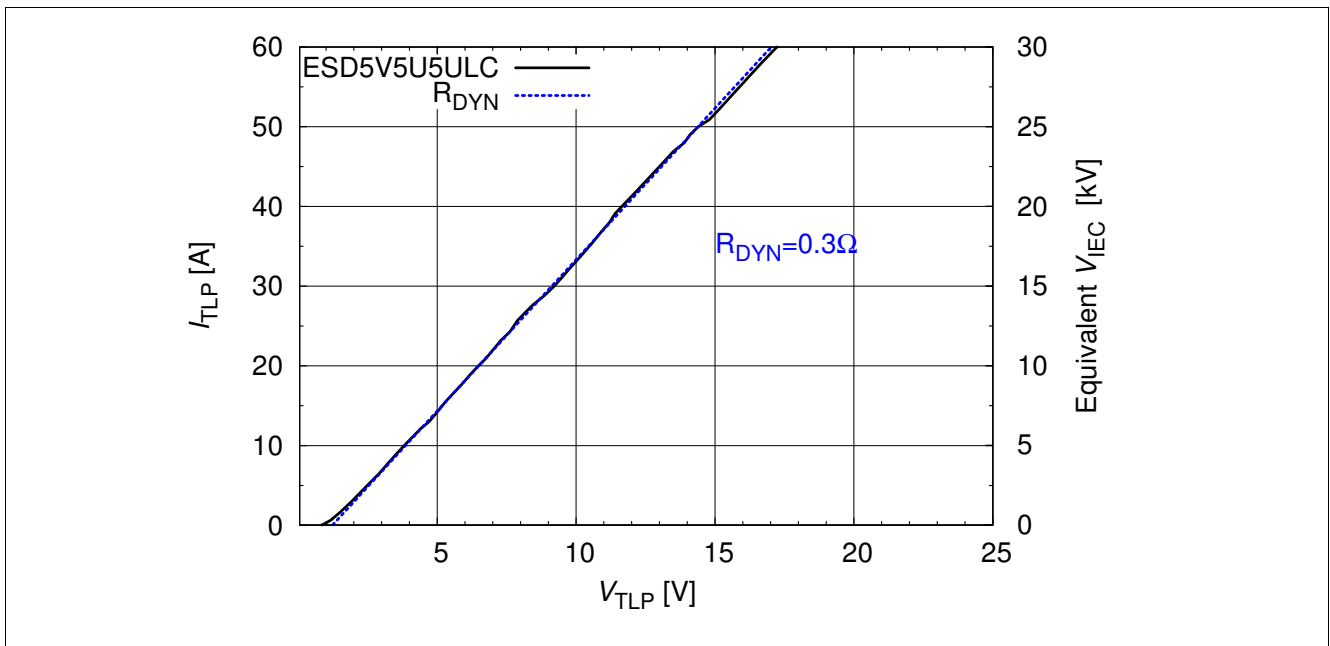

Figure 10 TLP characteristic GND to I/O ^{Note: [2]}

Note: TLP parameter: $Z_0 = 50 \Omega$, $t_p = 100 \text{ ns}$, $t_r = 300 \text{ ps}$, averaging window: $t_1 = 30 \text{ ns}$ to $t_2 = 60 \text{ ns}$, extraction of dynamic resistance using least squares fit of TLP characteristic between $I_{PP1} = 10 \text{ A}$ and $I_{PP2} = 40 \text{ A}$. The equivalent stress level V_{IEC} according IEC 61000-4-2 ($R = 330 \Omega$, $C = 150 \text{ pF}$) is calculated at the broad peak of the IEC waveform at $t = 30 \text{ ns}$ with 2 A / kV

3 Application Information

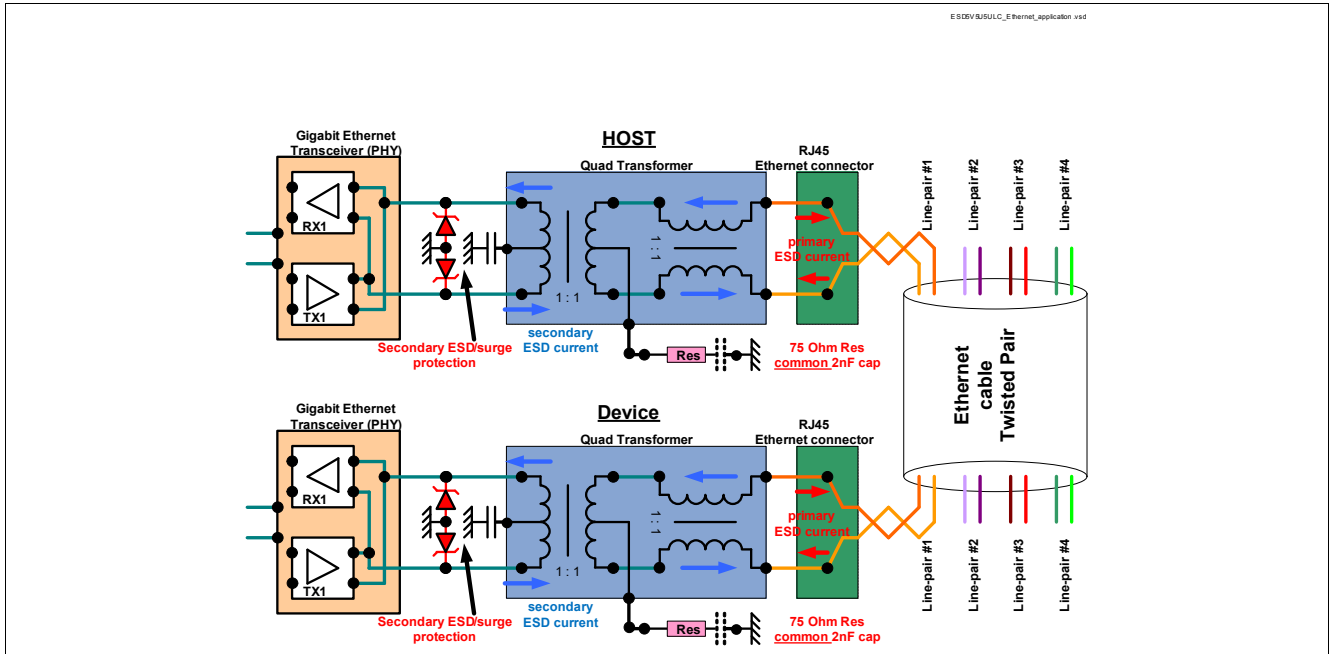

Figure 11 Ethernet

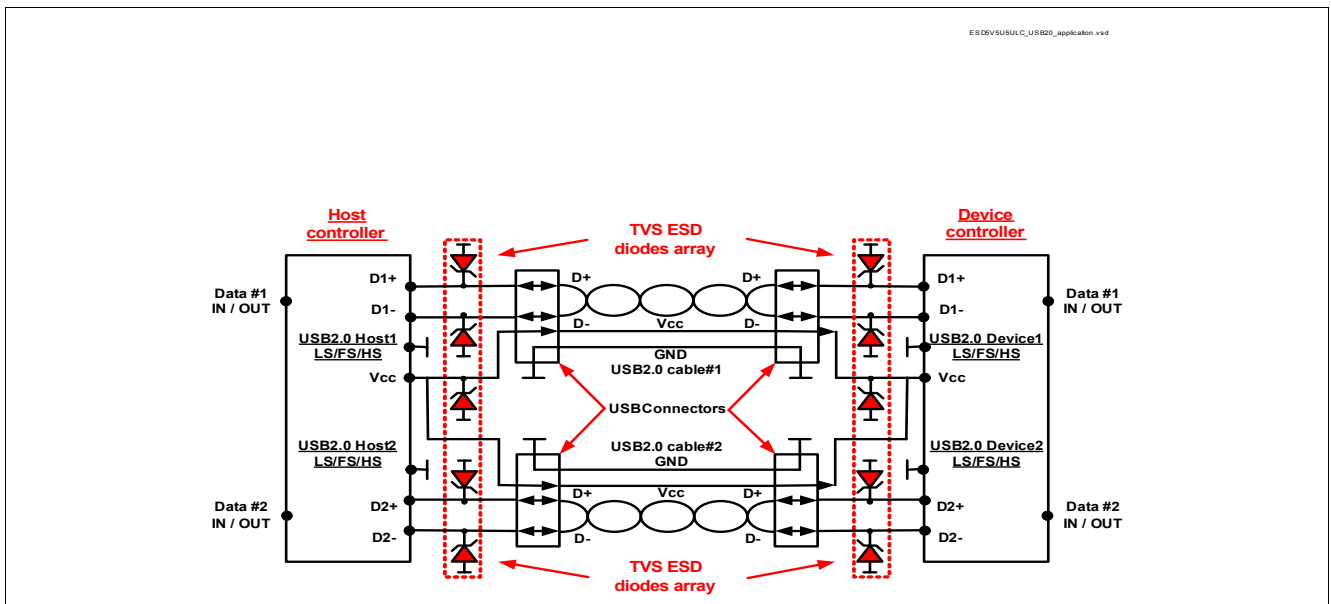

Figure 12 USB2.0

4 Ordering Information Scheme (Examples)

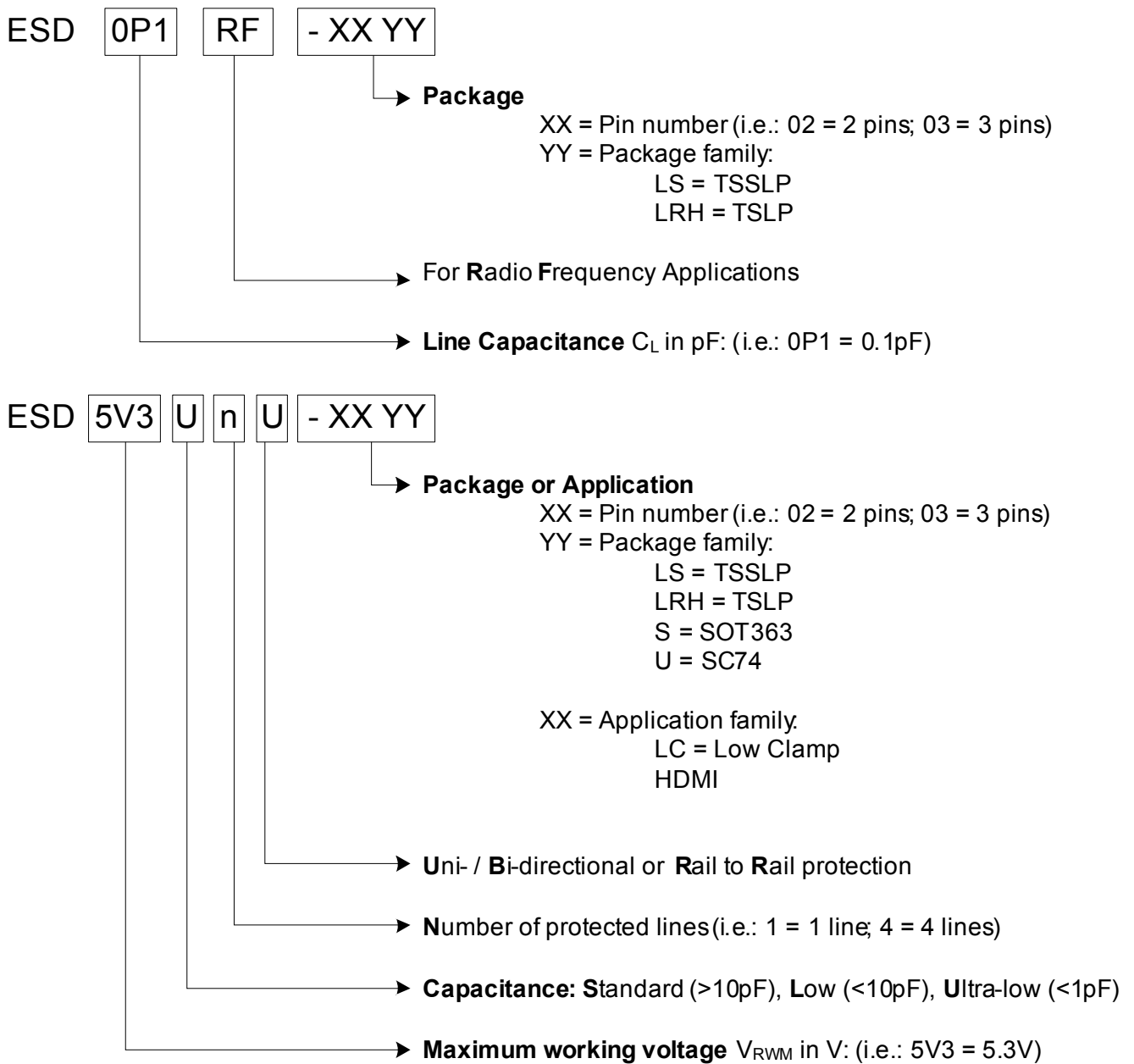

Figure 13 Ordering information scheme

5 Package Information

5.1 PG-SC74 (mm)

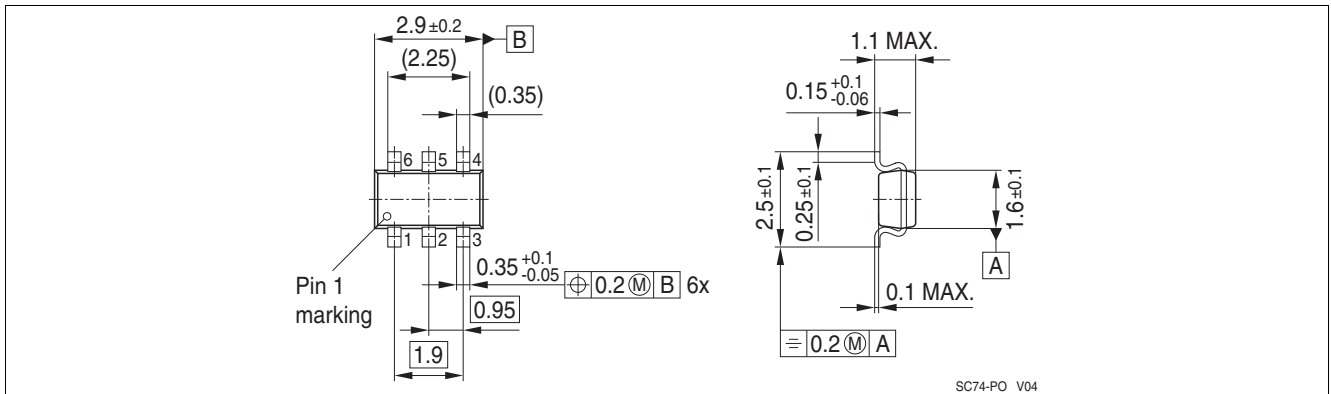

Figure 14 PG-SC74: Package overview

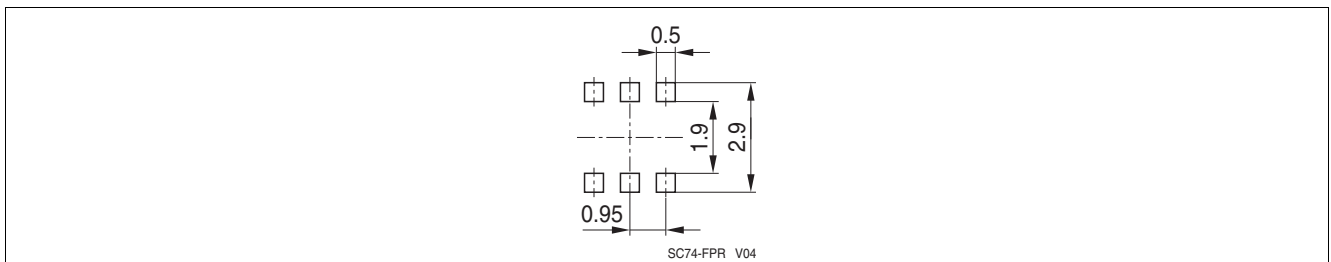

Figure 15 PG-SC74: Footprint

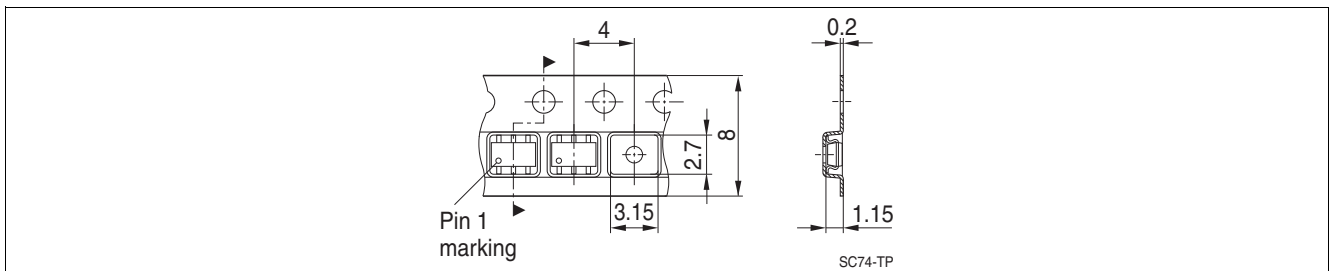

Figure 16 PG-SC74: Packing

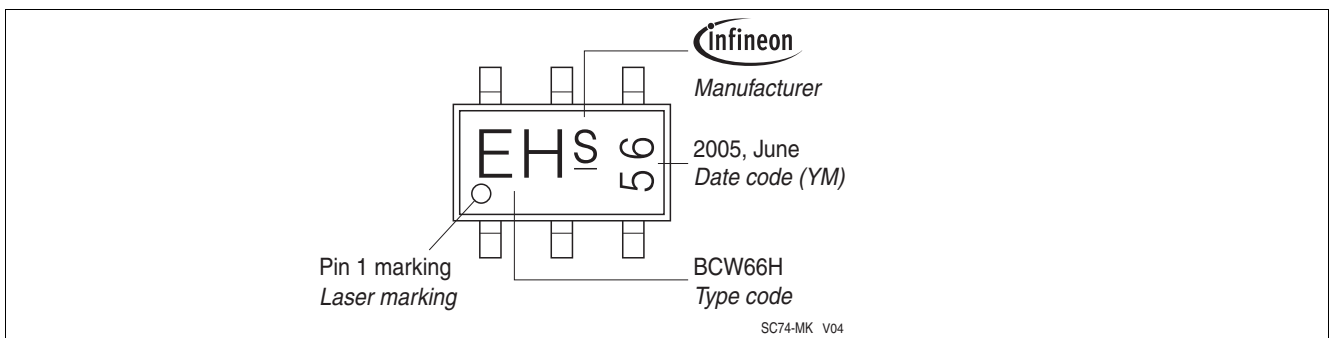

Figure 17 PG-SC74: Marking (example)

References

- [1] **On-chip ESD protection for integrated circuits**, Albert Z. H. Wang, ISBN:0-7923-7647-1
- [2] Infineon Technologie AG - **Application Note AN210**: Effective ESD Protection Design at System Level Using VF-TLP Characterization Methodology

Revision History: Rev. 1.3, 2015-07-16

Page or Item	Subjects (major changes since previous revision)
Revision 1.4, 2016-06-27	
4	Correction of typing error

Trademarks of Infineon Technologies AG

AURIX™, BlueMoon™, COMNEON™, C166™, CROSSAVE™, CanPAK™, CIPOS™, CoolMOS™, CoolSET™, CORECONTROL™, DAVE™, EasyPIM™, EconoBRIDGE™, EconoDUAL™, EconoPACK™, EconoPIM™, EiceDRIVER™, EUPEC™, FCOS™, HITFET™, HybridPACK™, ISOFACE™, I²RF™, IsoPACK™, MIPAQ™, ModSTACK™, my-d™, NovalithIC™, OmniTune™, OptiMOS™, ORIGA™, PROFET™, PRO-SIL™, PRIMARION™, PrimePACK™, RASIC™, ReverSave™, SatRIC™, SIEGET™, SINDRION™, SMARTi™, SmartLEWIS™, TEMPFET™, thinQ!™, TriCore™, TRENCHSTOP™, X-GOLD™, XMM™, X-PMU™, XPOSYS™.

Other Trademarks

Advance Design System™ (ADS) of Agilent Technologies, AMBA™, ARM™, MULTI-ICE™, PRIMECELL™, REALVIEW™, THUMB™ of ARM Limited, UK. AUTOSAR™ is licensed by AUTOSAR development partnership. Bluetooth™ of Bluetooth SIG Inc. CAT-iq™ of DECT Forum. COLOSSUS™, FirstGPS™ of Trimble Navigation Ltd. EMV™ of EMVCo, LLC (Visa Holdings Inc.). EPCOS™ of Epcos AG. FLEXGO™ of Microsoft Corporation. FlexRay™ is licensed by FlexRay Consortium. HYPERTERMINAL™ of Hilgraeve Incorporated. IEC™ of Commission Electrotechnique Internationale. IrDA™ of Infrared Data Association Corporation. ISO™ of INTERNATIONAL ORGANIZATION FOR STANDARDIZATION. MATLAB™ of MathWorks, Inc. MAXIM™ of Maxim Integrated Products, Inc. MICROTEC™, NUCLEUS™ of Mentor Graphics Corporation. Mifare™ of NXP. MIPI™ of MIPI Alliance, Inc. MIPS™ of MIPS Technologies, Inc., USA. muRata™ of MURATA MANUFACTURING CO., MICROWAVE OFFICE™ (MWO) of Applied Wave Research Inc., OmniVision™ of OmniVision Technologies, Inc. Openwave™ Openwave Systems Inc. RED HAT™ Red Hat, Inc. RFMD™ RF Micro Devices, Inc. SIRIUS™ of Sirius Sattelite Radio Inc. SOLARIS™ of Sun Microsystems, Inc. SPANSION™ of Spansion LLC Ltd. Symbian™ of Symbian Software Limited. TAIYO YUDEN™ of Taiyo Yuden Co. TEAKLITE™ of CEVA, Inc. TEKTRONIX™ of Tektronix Inc. TOKO™ of TOKO KABUSHIKI KAISHA TA. UNIX™ of X/Open Company Limited. VERILOG™, PALLADIUM™ of Cadence Design Systems, Inc. VLYNQ™ of Texas Instruments Incorporated. VXWORKS™, WIND RIVER™ of WIND RIVER SYSTEMS, INC. ZETEX™ of Diodes Zetex Limited.

Last Trademarks Update 2010-06-09

www.infineon.com

Published by Infineon Technologies AG