

DEMO_FX3_LVDS_CAM01 EZ-USB™ FX3 BT.1120/LVDS camera interface kit guide

About this document

Scope and purpose

This document is a user guide for the DEMO_FX3_LVDS_CAM01 EZ-USB™ FX3 BT.1120/LVDS camera interface kit. This kit enables you to stream USB Video Class (UVC) and USB3 Vision (U3V) 1080p videos at 60 fps from the block cameras to a PC using BT.1120 or LVDS protocols. Refer to the relevant sections based on your requirement:

- [Introduction](#) – Provides basic information on the kit
- [Installing the kit software](#) – Explains the installation of software required to program the kit
- [Kit hardware](#) – Explains the kit architecture and system design details
- [Kit programming](#) – Describes the procedure to program the kit
- [Kit operation](#) – Explains the procedure to operate the kit

Intended audience

This document is intended for the users of DEMO_FX3_LVDS_CAM01 EZ-USB™ FX3 BT.1120/LVDS camera interface kit.

Table of contents

Table of contents	2
1 Introduction	3
1.1 Kit contents	3
1.2 Download kit documents and hardware design files	3
1.3 Board details	4
1.4 Kit features	4
2 Installing the kit software	5
2.1 Before you start.....	5
2.2 Install FX3 SDK.....	5
2.3 Install Pleora eBUS Player.....	5
3 System design	6
3.1 Top-level hardware design	6
3.2 DEMO_FX3_LVDS_CAM01 design details.....	6
3.2.1 USB connector (J1)	6
3.2.2 Mode selection switch (SW1)	6
3.2.3 Power supply.....	7
3.2.4 EZ-USB™ FX3 (U6).....	7
3.2.5 SPI flash (U11)	7
3.2.6 LVDS camera coaxial connector (J6)	7
3.2.7 FPC connector (J7)	7
3.2.8 Crystal (Y1, Y2)	7
3.2.9 LED (LED1, LED2).....	7
3.2.10 Lattice ECP5 FPGA (U10)	8
3.2.11 DDR3 RAM (U12)	8
4 Programming the FX3 camera interface kit	9
5 Kit operation	12
5.1 Booting from the SPI flash	12
5.2 U3V video streaming from BT.1120 block camera	12
5.3 UVC video streaming from BT.1120 block camera.....	15
5.4 U3V video streaming from LVDS block camera.....	15
5.5 UVC video streaming from LVDS block camera.....	17
5.6 Streaming other resolutions.....	18
5.7 Changing camera parameters in LVDS block camera.....	20
6 Troubleshooting	22
6.1 Programming test	22
6.1.1 No bootloader device detected in USB Control Center	22
6.2 Video streaming test	22
6.2.1 FX3 not displayed in eBUS Player	22
6.2.2 Streaming gets stuck.....	22
6.3 Re-assigning the COM port.....	23
References	25
Technical support	26
Revision history	27

Introduction

1 Introduction

This kit is based on Infineon’s USB 5 Gbps controllers’ FX3 product family.

FX3 has a fully programmable General Programmable Interface (GPIF II) that can interface with any processor, ASIC, image sensor, or FPGA. It provides easy and effortless connectivity to popular industry interfaces such as synchronous slave FIFO and image sensor interfaces. This kit combines hardware, software, and documentation that enables the user to stream 1080p at 60 fps USB Video Class (UVC) and USB3 Vision (U3V) videos from the block cameras directly into the PC. This user guide describes the steps to install the software required by the kit and to operate the development board provided with the kit.

This kit is intended to be a solution demo kit for UVC and U3V video streaming applications from the block camera to a PC via the USB-C interface.

See the device datasheets [3] to understand and compare the various features supported by EZ-USB™ FX3 controllers.

This kit supports the following key features:

- UVC and U3V video streaming up to 1080p (FHD) at 60 fps from off-the-shelf BT.1120 and LVDS block cameras
- USB bus-powered operation

For FX3 controller details, see the [webpage](#).

1.1 Kit contents

Table 1 lists the contents of this kit.

Table 1 Kit contents

Item	Type	Comments
FX3 BT.1120/LVDS camera interface kit	Hardware	-
USB-C 5 Gbps cable	Cable	-
30-pin, 0.5-mm flexible flat cable (FFC)	Cable	-
BT.1120 camera board	Block camera	-
Hard copy of the quick-start guide (QSG)	Documentation	-
Kit casing	Package	-
Foam	Package	To protect and maintain proper placement in the kit container

1.2 Download kit documents and hardware design files

Download the documents and the hardware design files for this kit from the kit webpage [2]. The documents include a QSG, kit user guide (this document) and release notes. The hardware design files include schematic, bill of materials (BOM), and layout files.

Introduction

1.3 Board details

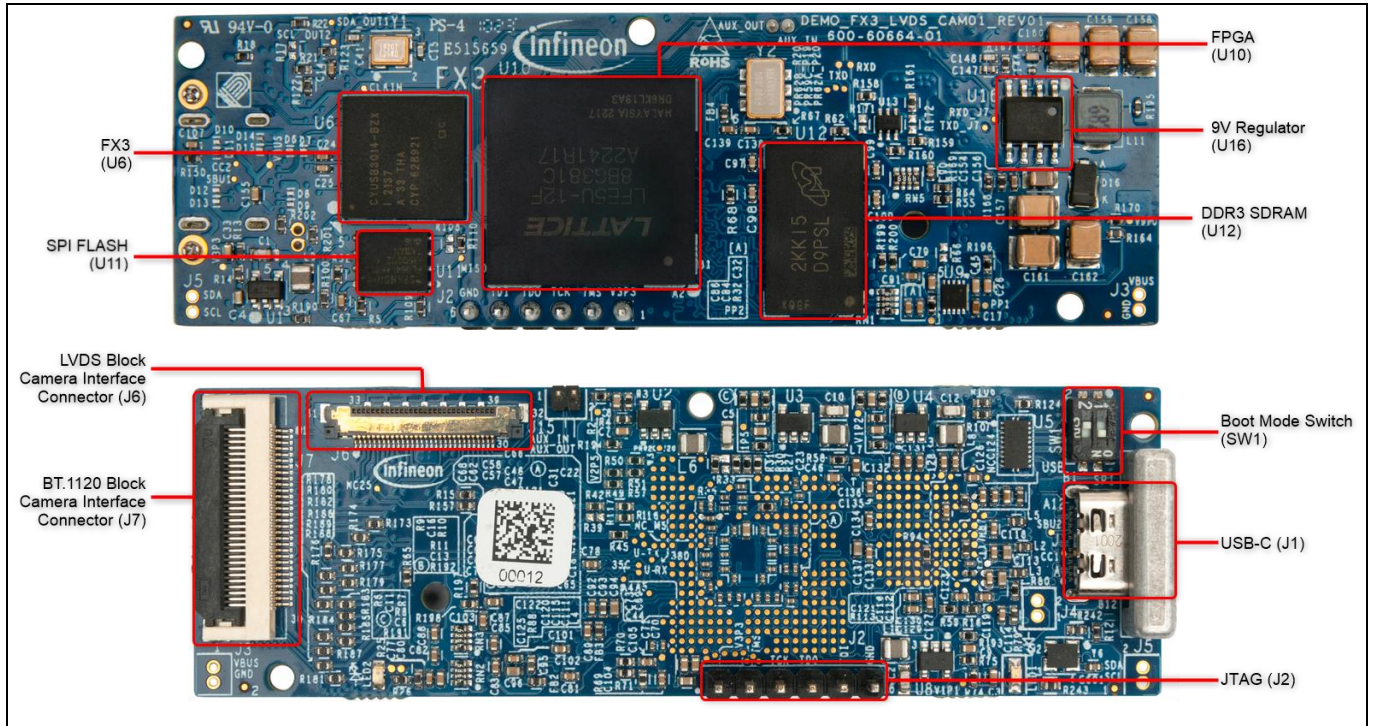

Figure 1 FX3 LVDS camera kit

1.4 Kit features

The kit features an FX3 controller and ECP5 FPGA from Lattice Semiconductor that can be configured to stream UVC and U3V video from block cameras into a PC. See [section 5](#) for more details.

Installing the kit software

2 Installing the kit software

2.1 Before you start

The installation of the FX3 SDK and other Infineon software may require administrator privileges. However, privileges are not required to run the software once it is installed.

2.2 Install FX3 SDK

Download and install [EZ-USB™ FX3 software development kit](#) to program the DEMO_FX3_LVDS_CAM01 kit.

Installable packages are available for Windows, Linux, and macOS.

After the installation is complete, the contents are available at *<Install Directory>\EZ-USB FX3 SDK*.

Notes:

1. The default *<Install Directory>* is *C:\Program Files(x86)\Cypress*.
2. See **GettingStartedWithFX3SDK.pdf** available in the installation directory for more details.

2.3 Install Pleora eBUS Player

Download and install Pleora eBUS Player:

- For [Windows 64-bit](#)
- For [Windows 32-bit](#)

System design

3 System design

This kit is bus-powered. To demonstrate the full functionality of the kit, connect the block/bt.1120 camera module to the onboard Low Voltage Differential Signaling (LVDS) or FFC connectors respectively.

3.1 Top-level hardware design

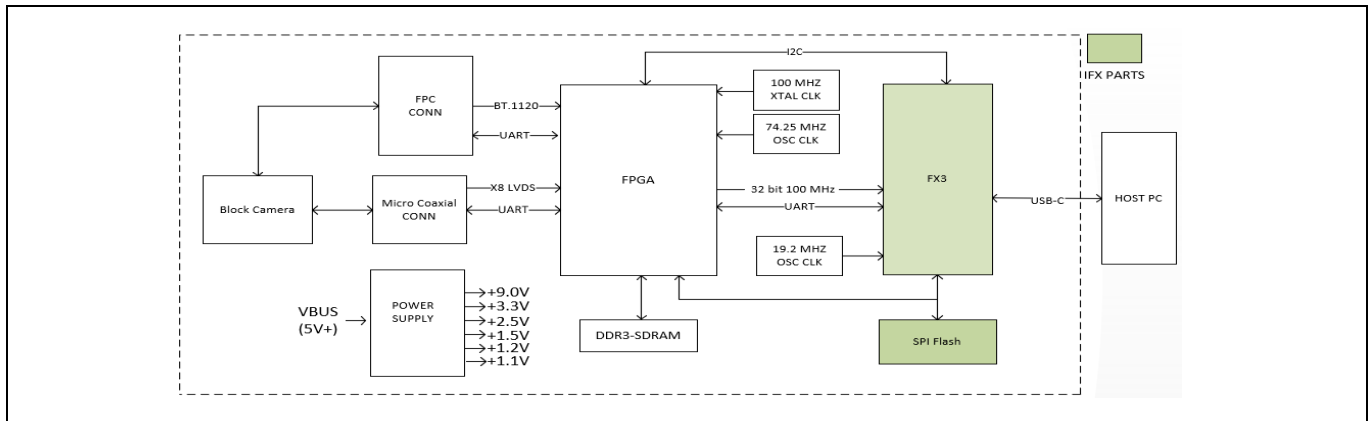

Figure 2 FX3 LVDS camera kit architecture

3.2 DEMO_FX3_LVDS_CAM01 design details

The DEMO_FX3_LVDS_CAM01 board consists of the FX3 silicon (CYUSB3014-BZXI), USB 5 Gbps MUX, 64-Mbit SPI flash, ECP5 FPGA and DDR3 SDRAM, and power supplies. The kit is bus-powered and uses a 19.2-MHz crystal for operation. The kit has an FPC interface to connect to the BT.1120 block camera module provided with the kit. An LVDS block camera can also be connected to this kit via the micro coaxial connector available on the board. Apart from these interfaces, the kit has a USB-C interface to connect to PC.

3.2.1 USB connector (J1)

An onboard certified USB-C receptacle (J1) allows FX3 to communicate with the PC via a USB-C 5 Gbps cable provided with the kit. Using the Type-C interface allows access to the FX3 debug interface using serial terminal messages.

3.2.2 Mode selection switch (SW1)

This switch selects the mode in which FX3 must boot upon power-on. The kit can boot in two modes based on the position of this switch.

Table 2 Boot modes

Boot mode	PMODE1	PMODE2
USB	SW1.2 ON	SW1.1 OFF
SPI	SW2.2 OFF	SW1.1 ON

To program the device, set SW1 in USB mode. After programming, setting the mode switch in SPI mode and rebooting the device by power cycle allows FX3 to boot from the onboard SPI flash.

System design

3.2.3 Power supply

The kit consists of five DC-DC buck and one DC-DC boost regulators with ratings as listed below. AP3428KTTR-G1 and PAM2423AECADJR from Diodes Inc. are used due to their small form factor. All voltages listed below are generated from VBUS (i.e., $5\text{ V} \pm 0.25\text{ V}$).

- U1: $3.3\text{ V} \pm 5\%$ at 1 A
- U2: $2.5\text{ V} \pm 5\%$ at 1 A
- U3: $1.5\text{ V} \pm 5\%$ at 1 A
- U4: $1.2\text{ V} \pm 5\%$ at 1 A
- U8: $1.1\text{ V} \pm 5\%$ at 1 A
- U16: $9\text{ V} \pm 5\%$ at 5.5 A

The kit also uses a 2 A DDR termination controller (U9) to power the VTT bus terminations. It also provides the reference output to the DDR IC.

3.2.4 EZ-USB™ FX3 (U6)

This is a USB 3.1 Gen 1 5 Gbps controller with a 32-bit ARM926EJ core CPU and 512-KB embedded SRAM. It supports UVC, UAC, U3V, and USB Vendor Class protocols. With a general programmable interface (GPIF II) of 8-, 16-, 24-, and 32-bit data bus at 100 MHz, FX3 supports slave FIFO and parallel camera interface features. It has dedicated interfaces for SPI flash and I²C. FX3 supports selectable clock input frequencies at 19.2, 26, 38.4, and 52 MHz. Additionally, a dedicated 19.2-MHz crystal input support is also available. It has a 121-ball, 10- × 10-mm, 0.8-mm pitch, Pb-free ball grid array (BGA) package.

3.2.5 SPI flash (U11)

The kit firmware is stored on an Infineon 64-Mbit SPI flash. After power-on, FX3 fetches the required details from the firmware image, stores it in its RAM, and starts executing from it.

3.2.6 LVDS camera coaxial connector (J6)

The kit has an onboard 30-pin micro-coaxial connector to connect the LVDS block cameras.

3.2.7 FPC connector (J7)

The kit has an onboard 30-pin FPC connector to connect the BT.1120 block camera provided with the kit.

3.2.8 Crystal (Y1, Y2)

Y1 is a 19.2-MHz crystal used by FX3 to generate the clock for its operation.

Y2 is a 100-MHz crystal used by FPGA to generate the clock for its operation.

3.2.9 LED (LED1, LED2)

LED1 (user LED) is a green LED connected to GPIO_4 of FX3. It is an application / firmware-controlled LED.

LED2 (PWR ON) is a green LED with power on; this LED glows green, indicating the power to the LVDS camera board is available.

System design

3.2.10 Lattice ECP5 FPGA (U10)

The kit uses an ECP5 family FPGA from Lattice Semiconductor. It is a high-performance device with dedicated DDR3 RAM interfaces and supports high-speed signaling. This FPGA acts as a bridge between the block camera and the FX3 device.

This FPGA is a 381-ball BGA package with 197 I/Os, having 0.8-mm pitch and a dimension of 17mm x 17mm.

3.2.11 DDR3 RAM (U12)

This kit uses MT41K128M16JT-125 IT:K TR from Micron. It is a 2Gb 1600MT/s DDR3 SDRAM used by the FPGA as a frame buffer to process the digital video data received from block camera. It operates at $V_{DD} = V_{DDQ} = 1.5\text{ V} \pm 0.075\text{ V}$.

As with standard DDR SDRAM, the pipelined, multibank architecture of DDR3 SDRAM allows for concurrent operation, thereby providing high bandwidth by hiding row pre-charge and activation time.

The DDR3 RAM is an industrial grade 96-ball FBGA package.

Programming the FX3 LVDS camera kit

4 Programming the FX3 LVDS camera kit

The DEMO_FX3_LVDS_CAM01 kit is preprogrammed with the latest firmware to stream 1080p U3V videos at 60 fps from the BT.1120 block camera module provided with the kit. Use the USB Control Center application available in the FX3 SDK to change the firmware.

1. Set the SW1 switch on the kit to boot in the USB mode per [Table 2](#).

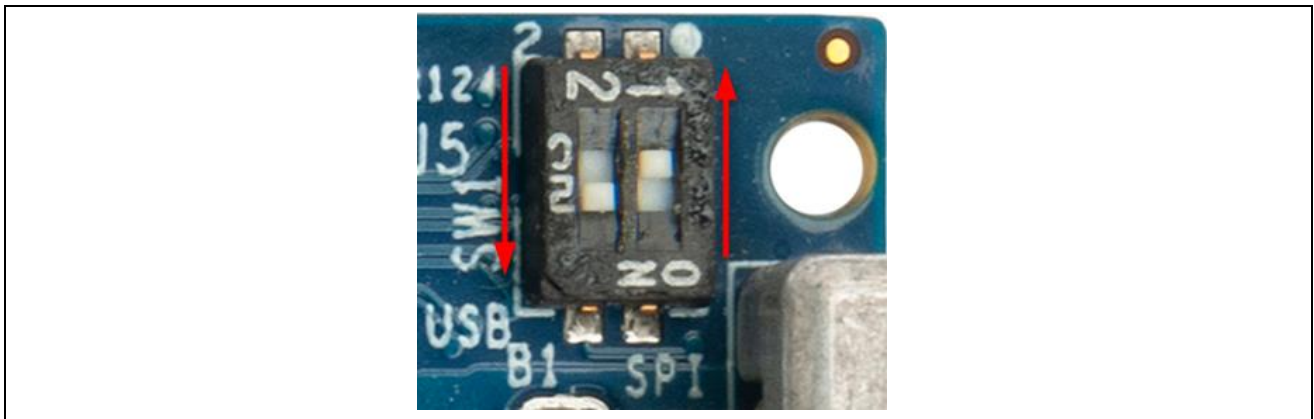

Figure 3 Boot mode switch in USB mode

2. Connect the kit to the PC using the USB-C 5 Gbps cable.

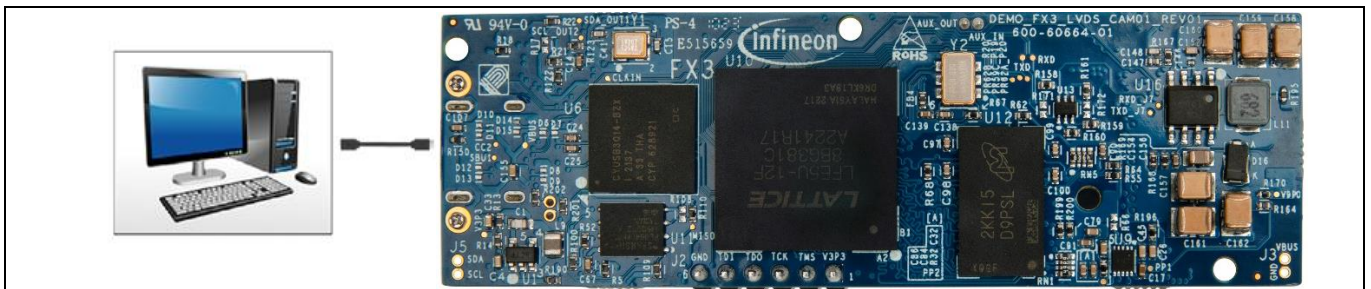

Figure 4 Connecting the kit with the PC

Programming the FX3 LVDS camera kit

- Open the EZ-USB™ Control Center application. If the application is not present on the desktop, browse to the FX3 SDK installation directory (C:\Program Files (x86)\Cypress\EZ-USB FX3 SDK).
The board should appear as “Cypress FX3 USB Bootloader Device” on the left pane of the USB Control Center application.

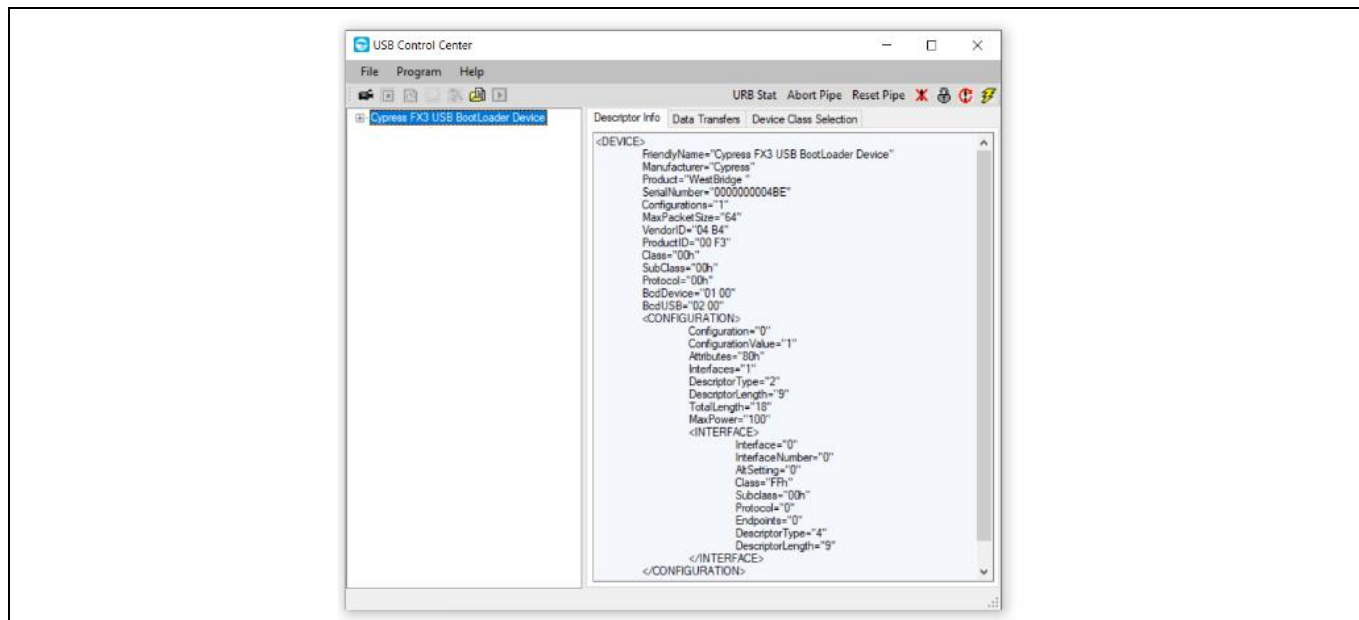

Figure 5 Device enumeration in control center application

- Click **Program > FX3 > SPI FLASH**

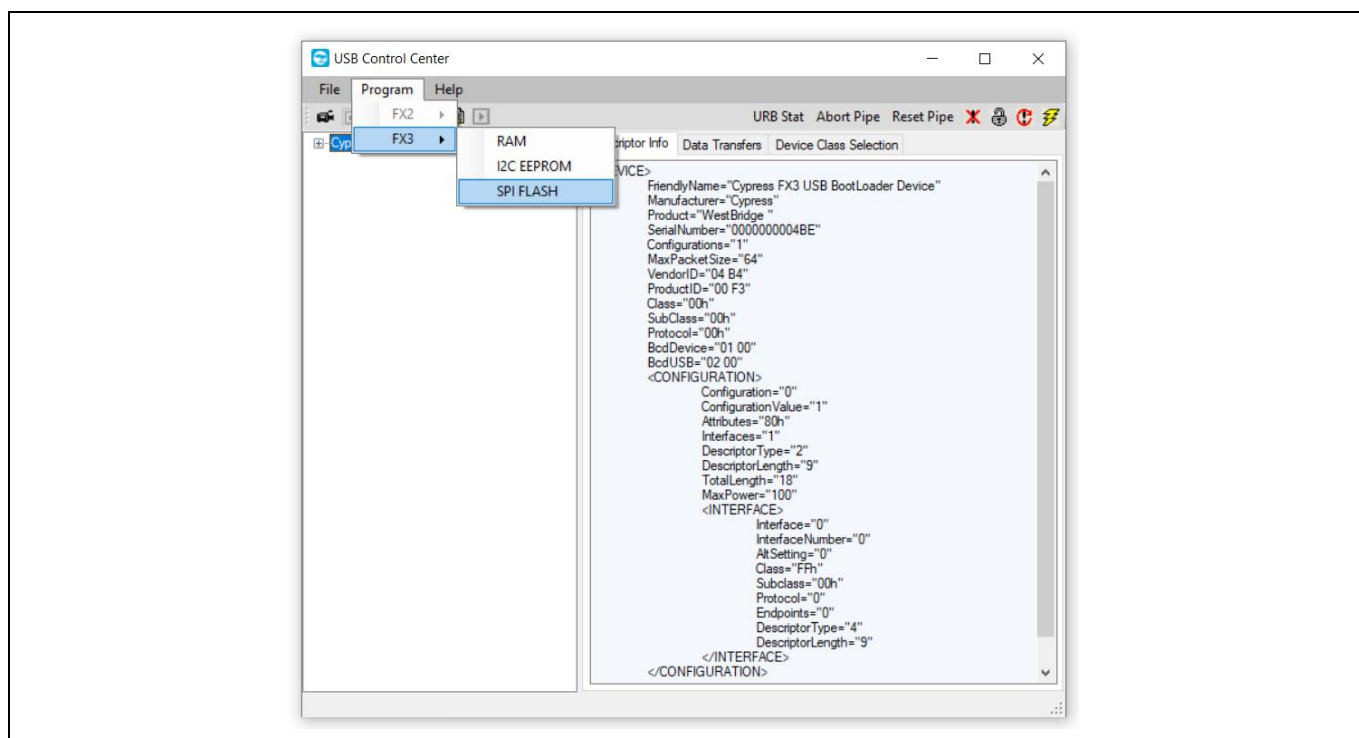

Figure 6 Programming the SPI FLASH

Programming the FX3 LVDS camera kit

5. Browse to select the downloaded firmware file

Table 3 FW image file

Mode	Testing Module	FW Image
UVC	BT.1120 Block Camera Board	FX3_MergedFirmware_BT1120_UVC.img
	LVDS Block Camera Board	FX3_MergedFirmware_LVDS_UVC.img
U3V	BT.1120 Block Camera Board	FX3_MergedFirmware_BT1120_U3V.img
	LVDS Block Camera Board	FX3_MergedFirmware_LVDS_U3V.img

6. Wait for programing to complete. The status appears on the bottom left of the window.

7. Disconnect the kit power by removing the USB cable from the PC.

Kit operation

5 Kit operation

Important note: Before starting the demo, ensure the kit is loaded with the appropriate firmware as shown in [Table 3](#).

5.1 Booting from the SPI flash

1. Set the SW1 switch setting to SPI position as follows:
Move SW1 pin 1 to ON position and pin 2 to OFF position.

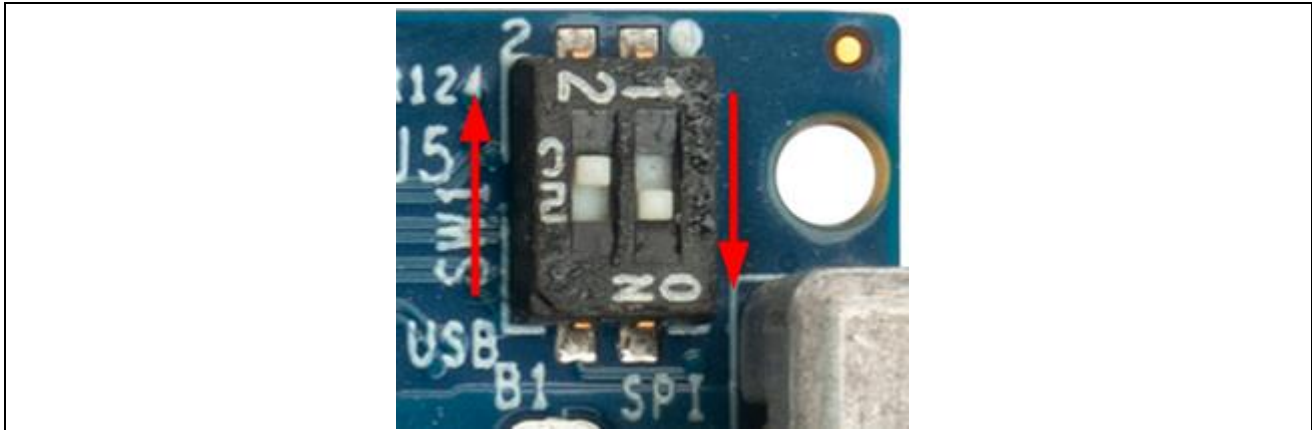

Figure 7 Boot mode switch in SPI mode

5.2 U3V video streaming from BT.1120 block camera

1. Ensure that the steps in [section 4](#) are followed and the FX3_MergedFirmware_BT1120_U3V.img firmware image is loaded.
2. Ensure that the steps in [section 5.1](#) are followed to boot from SPI flash.
3. Connect the BT.1120 block camera module provided with the kit to the FPC connector as shown in [Figure 8](#).
4. Connect the power by plugging the USB-C cable to the PC.

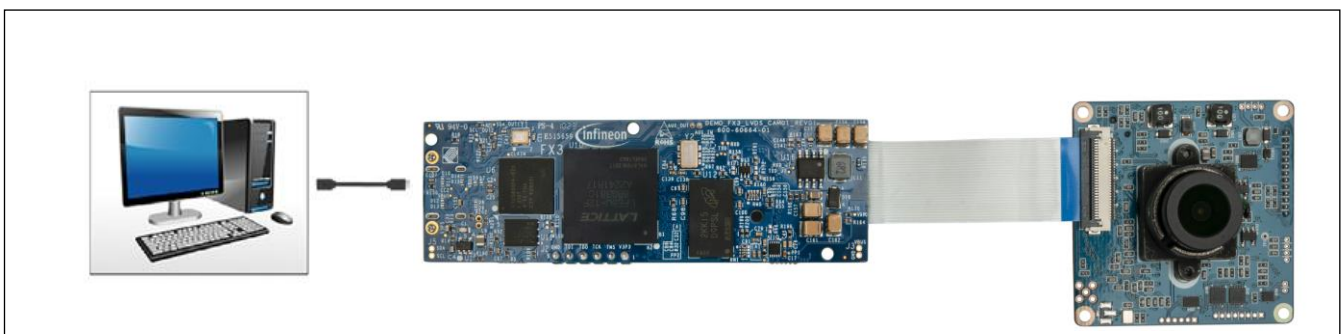

Figure 8 Connecting the kit to the USB port of PC

Kit operation

- Open the eBUS Player app. Click **Select/Connect** from the eBUS Player. Verify that FX3 is detected as shown in [Figure 9](#).

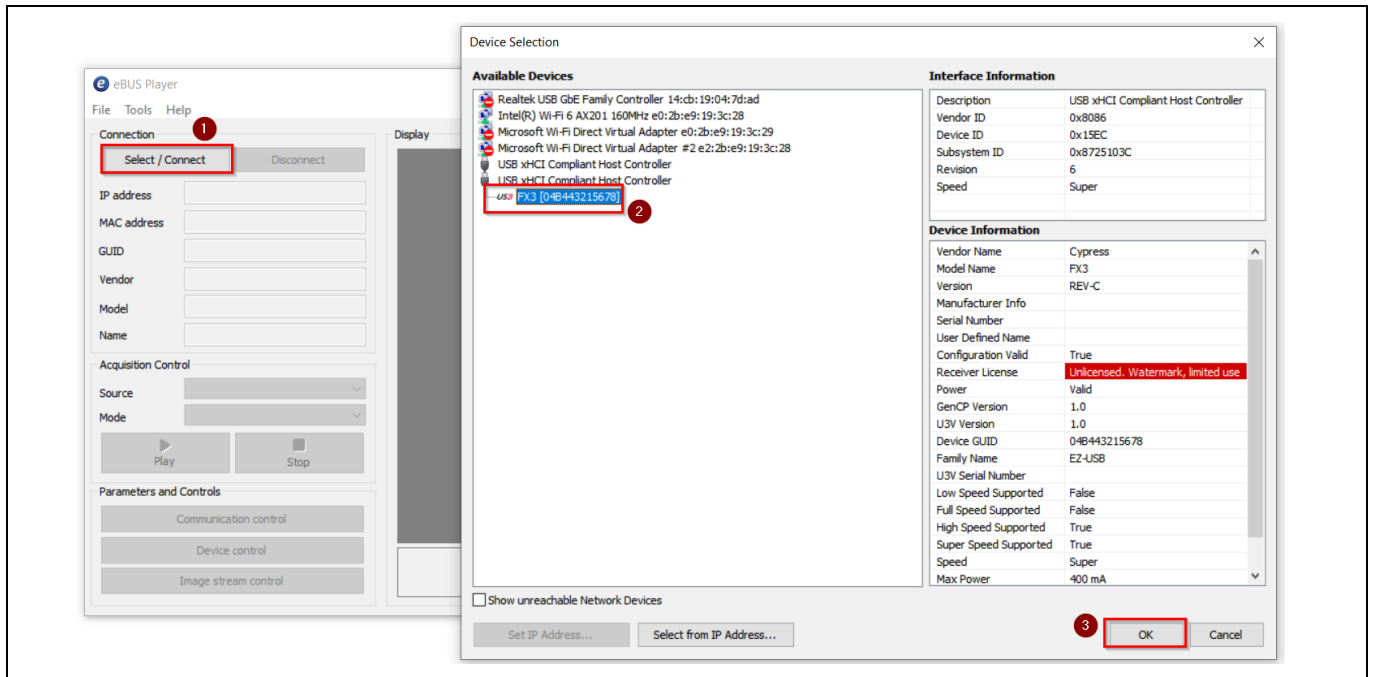

Figure 9 Selecting USB3 Vision device in eBUS Player application

- If FX3 is not detected, go to `C:\Program Files\Common Files\Pleora\eBUS SDK\U3V\Certified` and install the U3V driver as shown in [Figure 10](#).

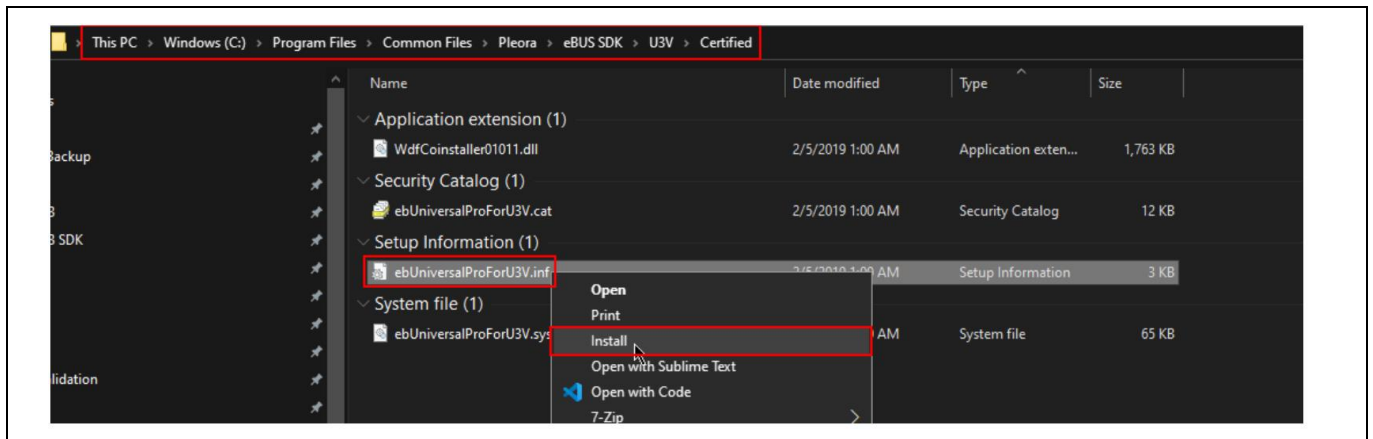

Figure 10 Installing the driver for USB3 Vision player (eBUS player)

Kit operation

- Click **Play** and observe the streaming video in the display pane.
You can check the streaming statistics in the status pane below the display pane. It should display 60 fps.

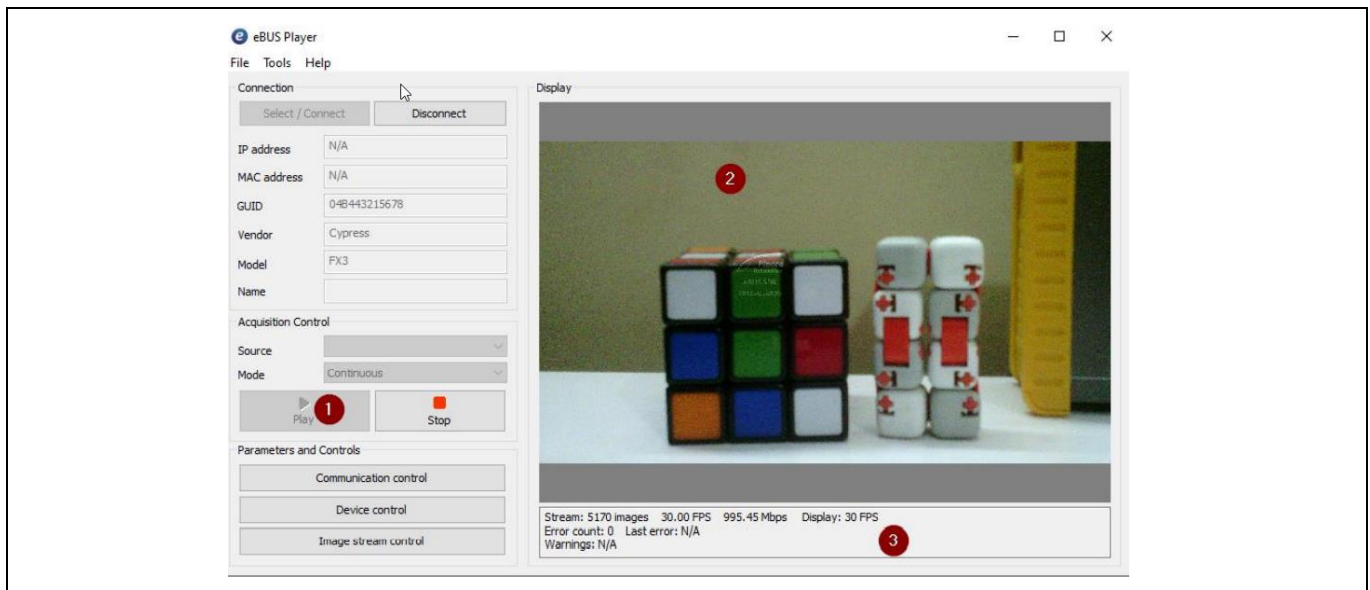

Figure 11 Check the streaming video in the display pane and its statistics in the status pane

- Click **Device control** and verify the streaming resolution is set to 1920 x 1080, indicating 1080p streaming.

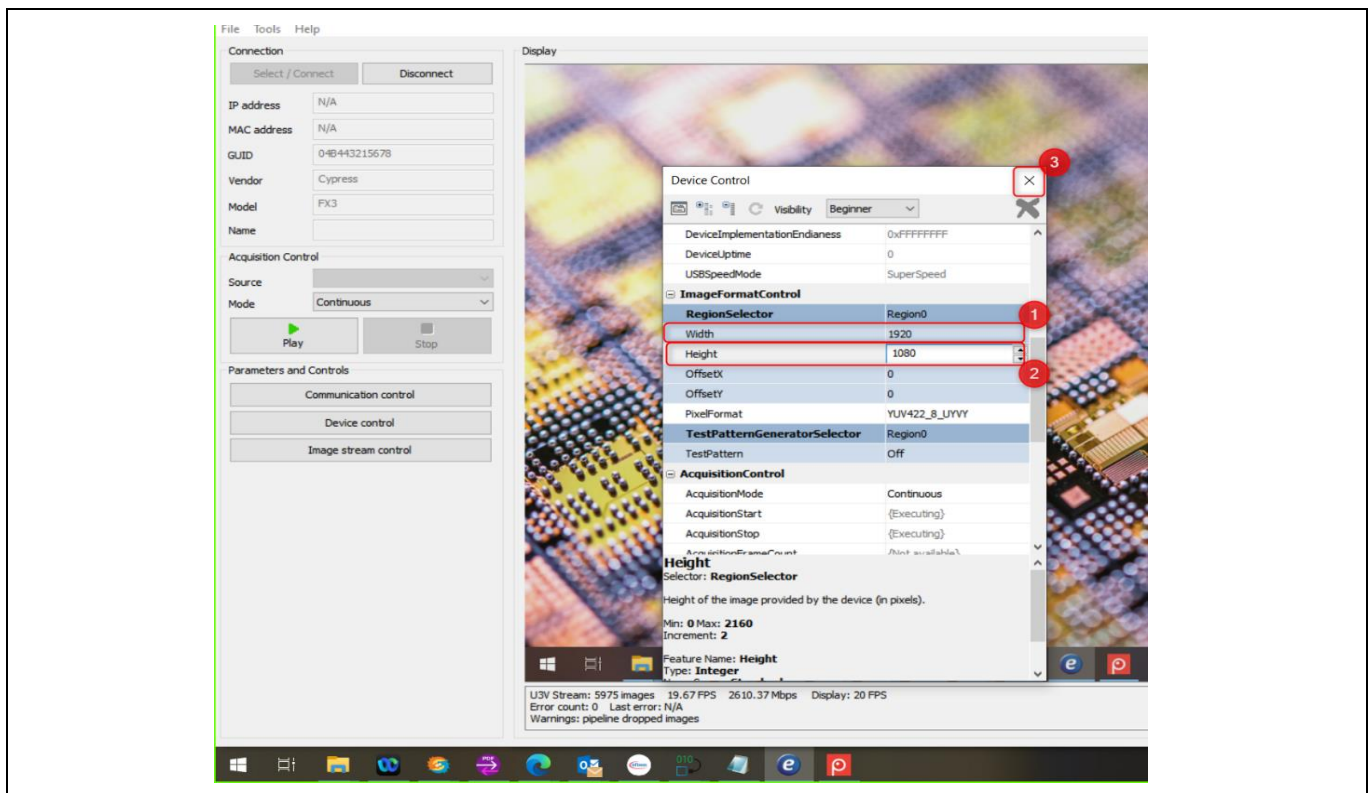

Figure 12 Device control settings

Kit operation

5.3 UVC video streaming from BT.1120 block camera

1. Ensure that the steps in [section 4](#) are followed and the FX3_MergedFirmware_BT1120_UVC.img firmware image is loaded.
2. Ensure that the steps in [section 5.1](#) are followed to boot from SPI flash.
3. Connect the BT.1120 block camera module provided with the kit to the FPC connector as shown in [Figure 8](#).
4. Reconnect the power by plugging the USB-C cable to the PC.
5. Open the camera application in Windows PC
6. Flip it to stream from the FX3 camera.

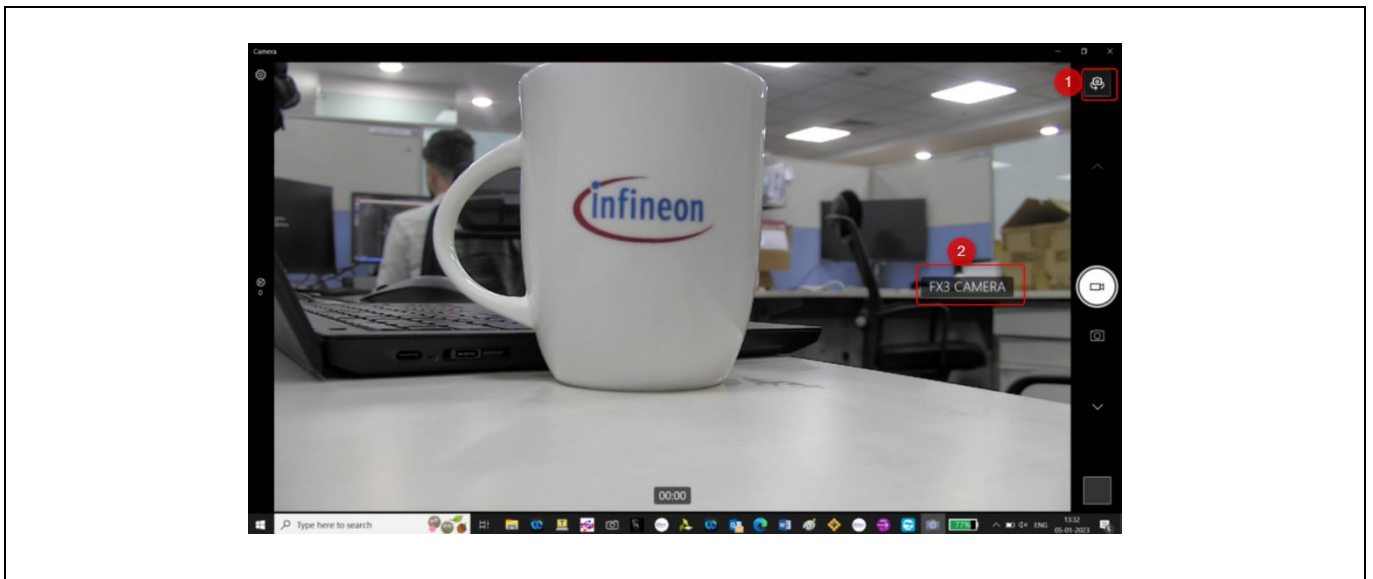

Figure 13 Check the streaming video in the camera application

5.4 U3V video streaming from LVDS block camera

1. Ensure that the steps in [section 4](#) are followed and the FX3_MergedFirmware_LVDS_U3V.img firmware image is loaded.
2. Ensure that the steps in [section 5.1](#) are followed to boot from SPI flash.
3. Connect the LVDS block camera module to the micro-coaxial connector (J6) present on-board.
4. Reconnect the power by plugging the USB-C cable to the PC.
5. Open the eBUS Player app.

Kit operation

6. Click **Select/Connect** from the eBUS player. Verify that FX3 is detected as shown in [Figure 14](#).

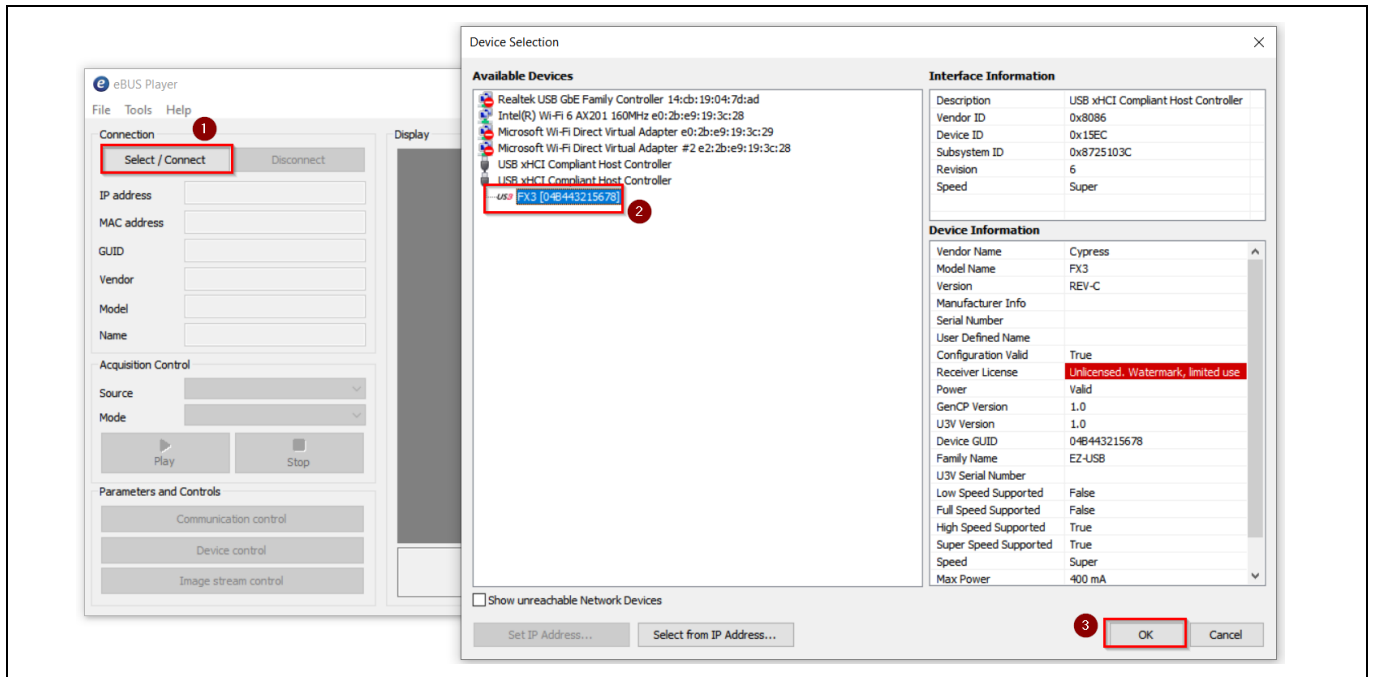

Figure 14 Selecting USB3 Vision device in eBUS Player application

7. Click **Play** and observe the streaming video in the display pane.
You can check the streaming statistics in the status pane below the display pane. It should display 60 fps.

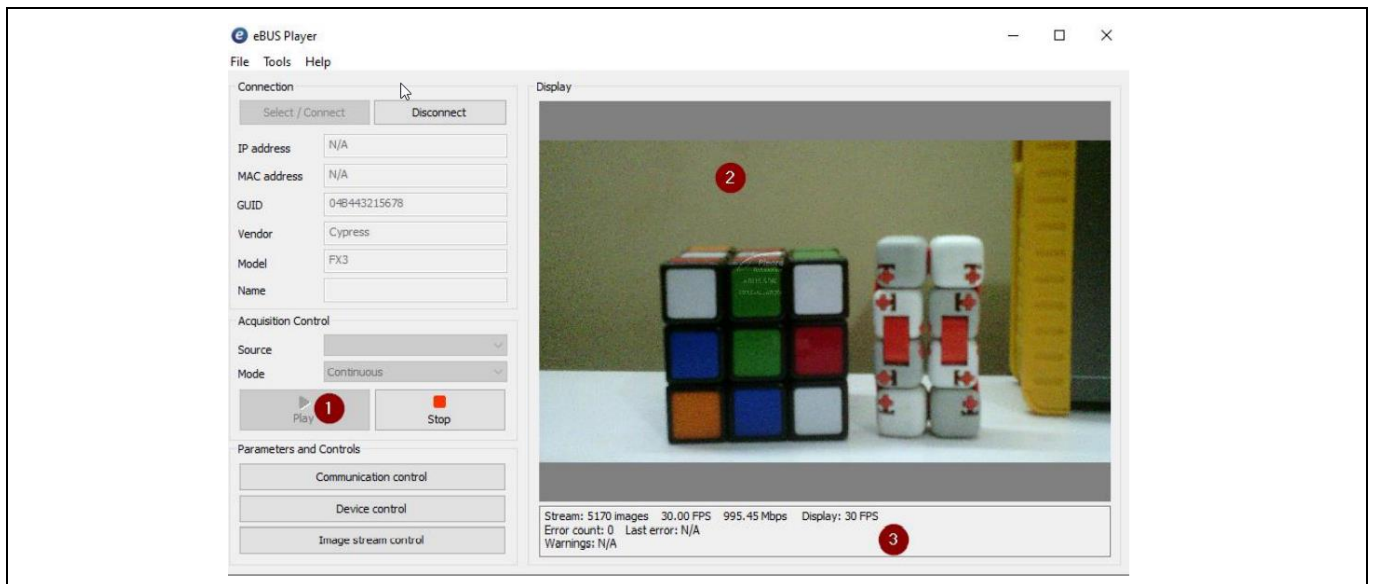

Figure 15 Check the streaming video in the display pane and its statistics in the status pane

Kit operation

- Click **Device control** and verify the streaming resolution is set to 1920 x 1080, indicating 1080p streaming.

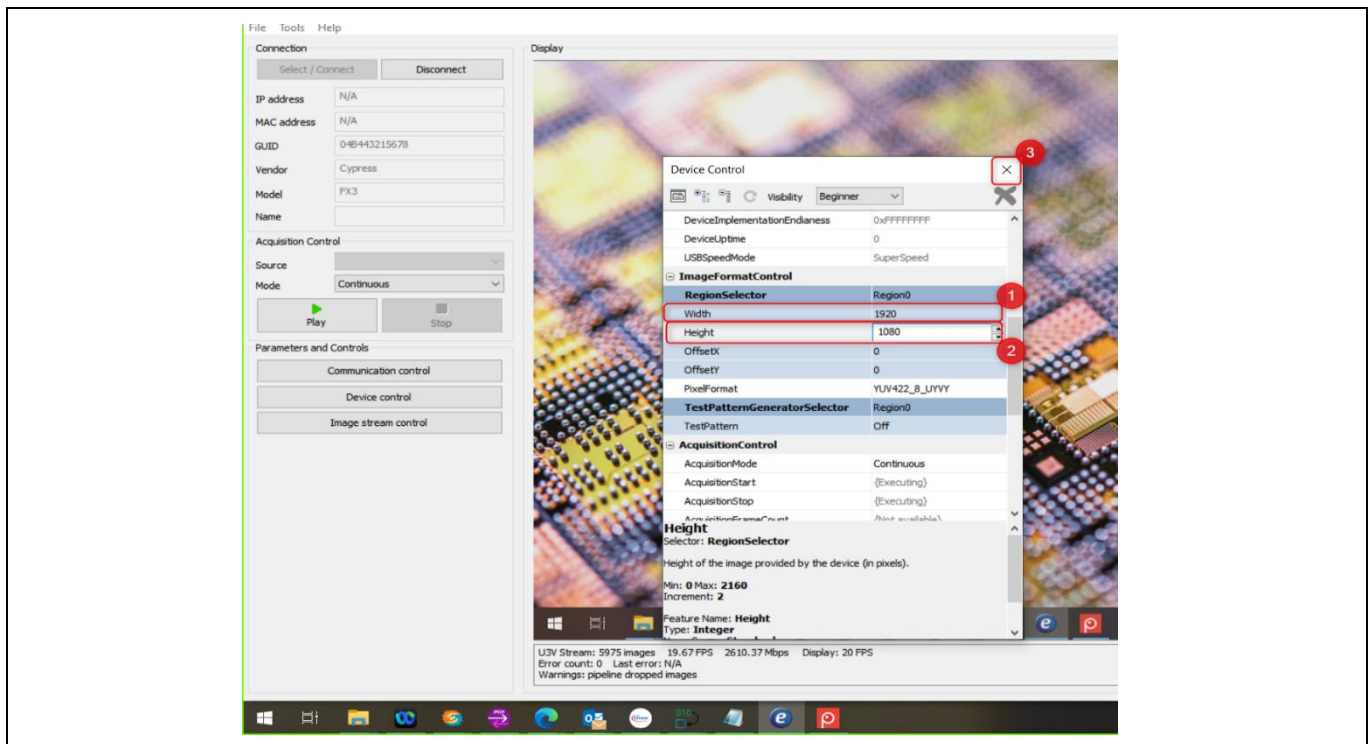

Figure 16 Device control settings

5.5 UVC video streaming from LVDS block camera

- Ensure that the steps in [section 4](#) are followed and SX3_MergedFirmware_LVDS_UVC.img firmware image is loaded.
- Ensure that the steps in [section 5.1](#) are followed to boot from SPI flash.
- Open the camera application, flip it to stream from the FX3 camera.

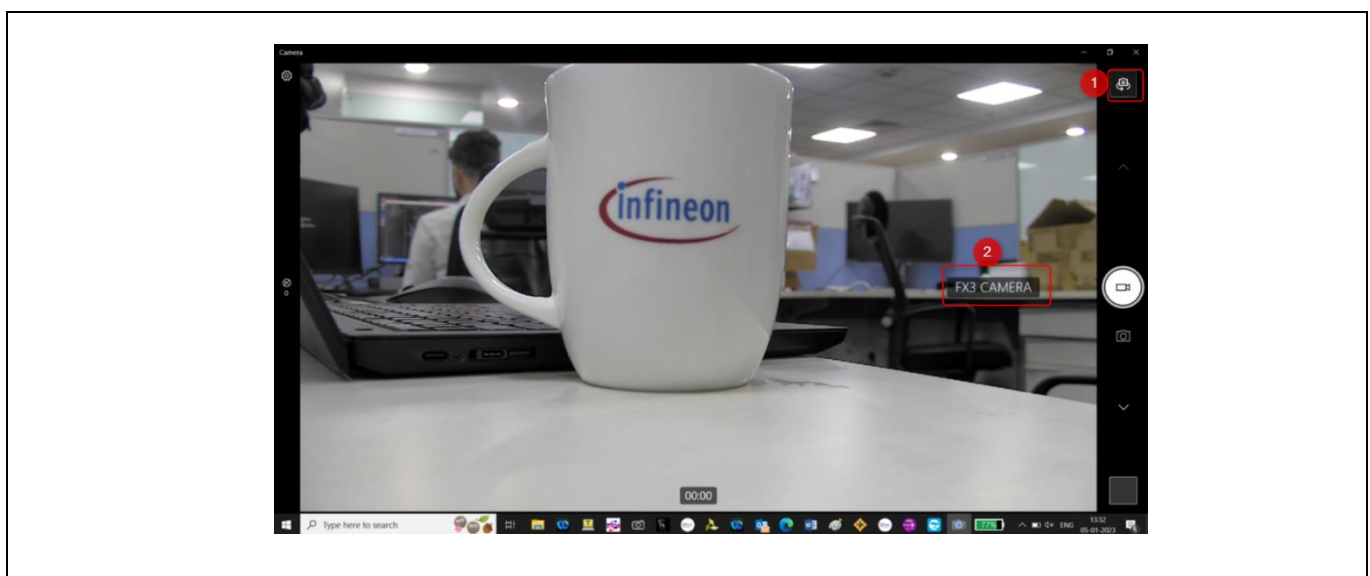

Figure 17 Check the streaming video in the camera application

Kit operation

5.6 Streaming other resolutions

1. This kit supports the following resolutions:

Table 4 Supported resolutions by this kit

Video type	Resolution (Width x Height)	Frame Rate (fps)
1080p	1920 x 1080	60
720p	1280 x 720	60

- Set the camera source resolution per [Table 4](#).
- You can change the streaming resolution in the eBUS player in the Device Control setting under Image Format Control. Ensure that you stop the streaming before doing this.

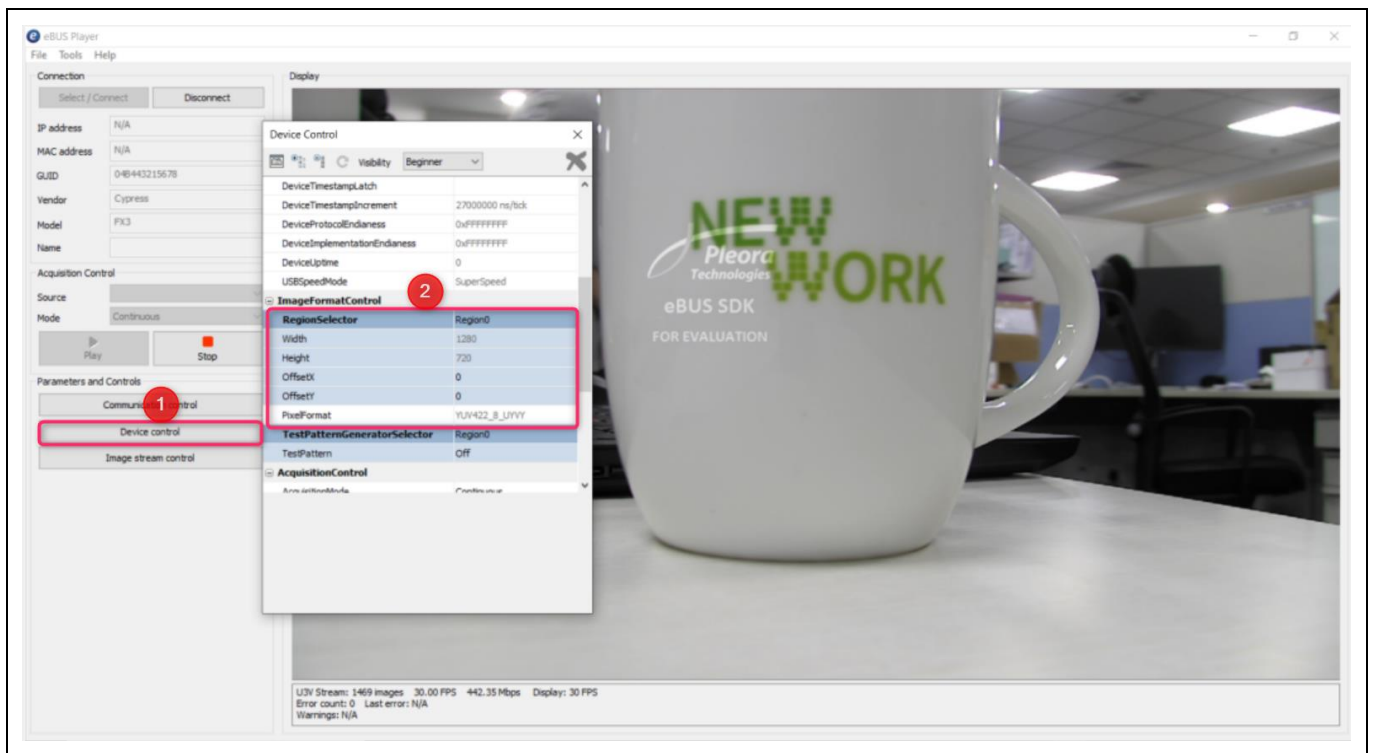

Figure 18 Device control settings

Kit operation

4. In the Width and Height fields, type the resolution needed as mentioned in [Table 4](#) and close the window.

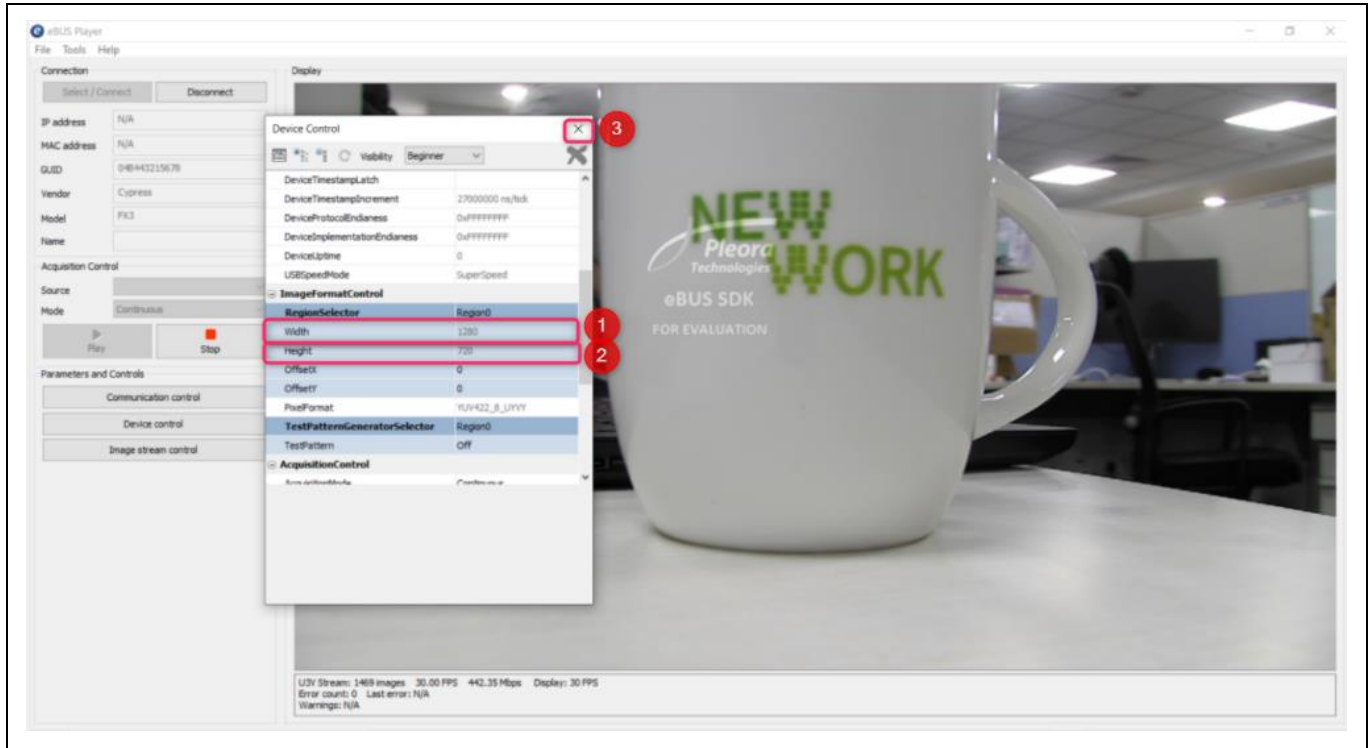

Figure 19 Display resolution changed to 720p

9. Click **Play** to stream the video.

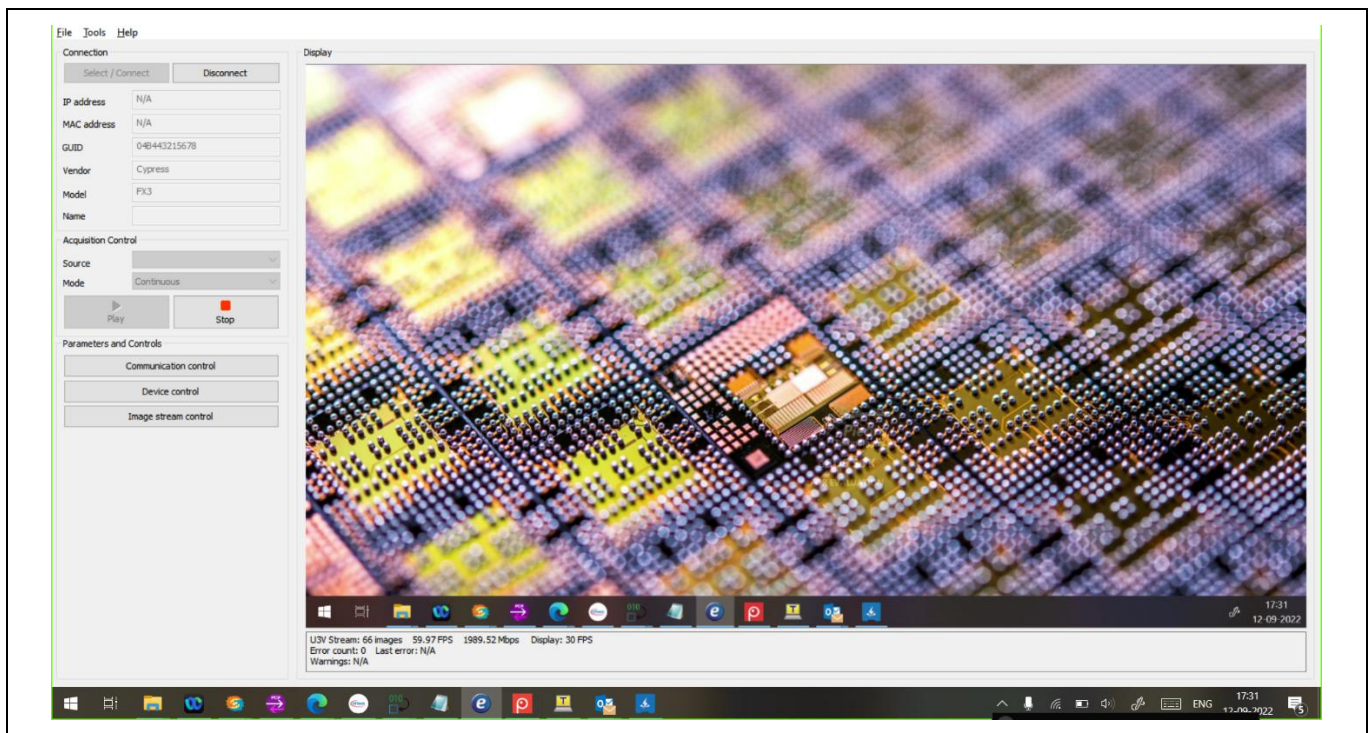

Figure 20 Video streaming at 720p

Kit operation

5.7 Changing camera parameters in LVDS block camera

Note: This kit supports modification of camera parameters only in the UVC streaming mode. However, it is also possible to implement this feature in the U3V mode.

To change the camera parameters, the VISCA serial commands are sent over USB CDC class.

The following are the prerequisites for changing the camera parameters:

1. Download and install [TeraTerm](#).
2. Download and install any VISCA serial control software such as [FCB Control software V5102.exe](#).

After streaming the UVC video from the LVDS camera as described in [section 5.5](#), open the device manager and confirm the following:

- FX3 CAMERA appears in the Camera group.
- Two COM ports appear in the Ports (COM&LPT) group. One COM port is used to debug prints and the other is used to control the camera using any VISCA serial control software. Find the COM port used to debug prints by opening [TeraTerm](#) with the selected COM port.

Note: The FCB Control software allows a COM port number of up to 16. Re-assign the COM port number to within 16 if the PC assigns a port number greater than 16 by following the steps given in [section 6.3](#).

Open [FCB Control Software V5102.exe](#) and choose the appropriate COM port and click **OK**.

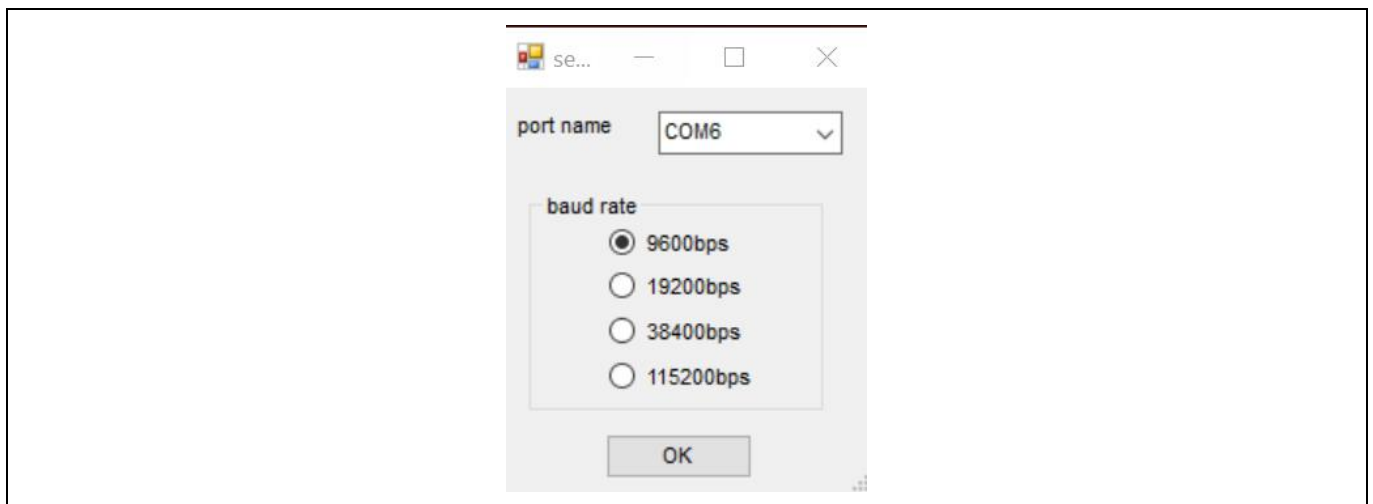

Figure 21 Selecting COM port in Sony FCB Control Software application

Kit operation

The application opens as shown in the following screenshot. It may throw up an error saying the FCB Control Software has stopped working. Ignore the warning and continue with controlling the camera with the provided feature.

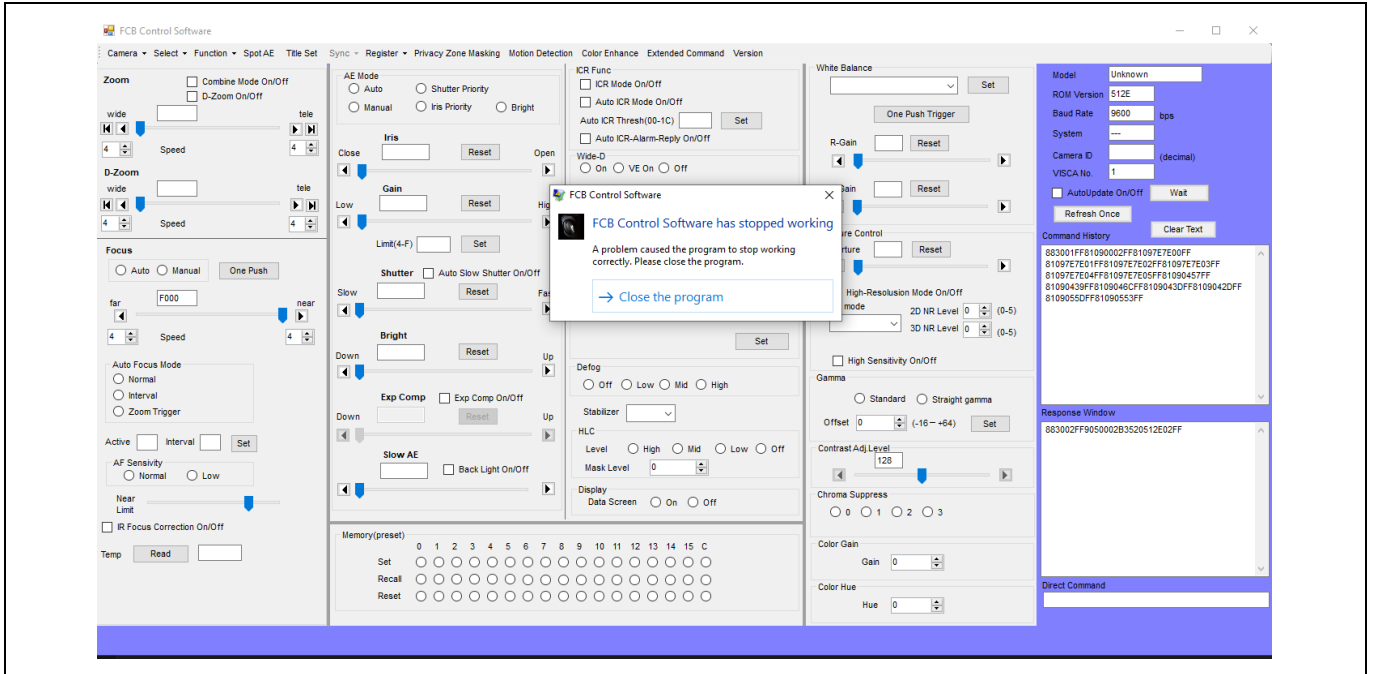

Figure 22 Sony FCB Control software application

You can control zoom, focus, AE mode brightness, and other parameters of the camera using the application.

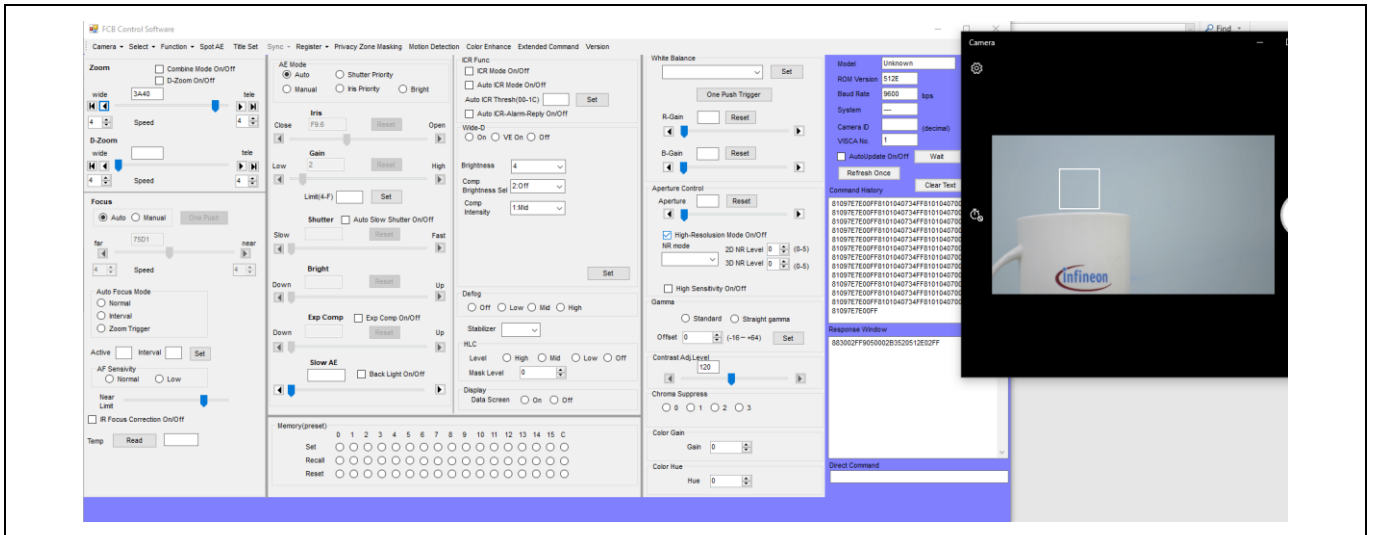

Figure 23 Streaming video

Troubleshooting

6 Troubleshooting

6.1 Programming test

6.1.1 No bootloader device detected in USB Control Center

If “Cypress FX3 USB Bootloader device” is not visible in the USB Control Center application, verify that the PMODE switch (SW1) is in the “USB” state.

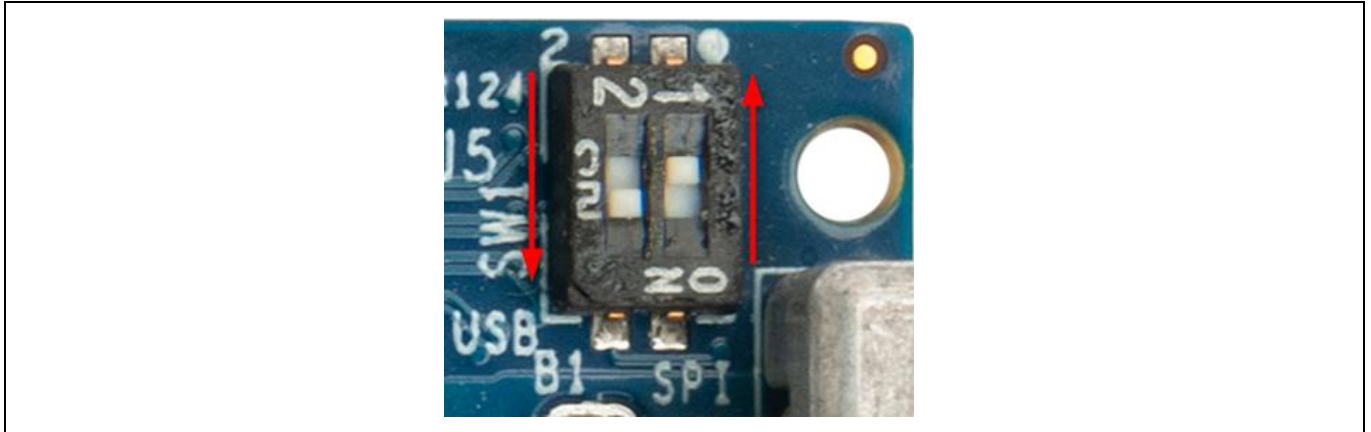

Figure 24 Mode switch setting for USB mode

6.2 Video streaming test

6.2.1 FX3 not displayed in eBUS Player

Verify that the PMODE switch (SW1) is in the SPI position.

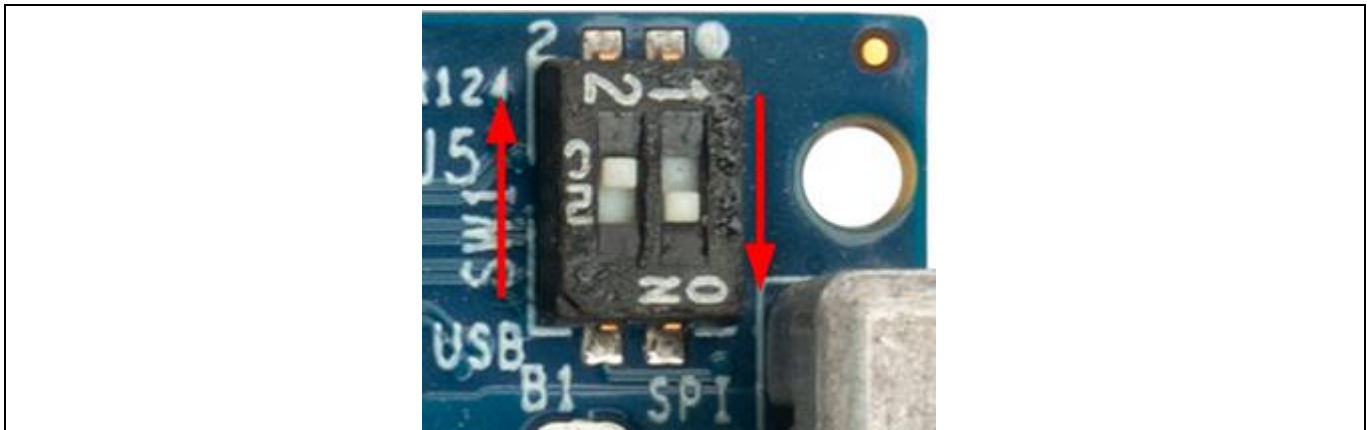

Figure 25 Boot mode switch in SPI mode

6.2.2 Streaming gets stuck

While changing the display resolution in the eBUS player, if the streaming gets stuck in a single frame, check in the system display setting if the proper fps is set per [Table 4](#).

Troubleshooting

6.3 Re-assigning the COM port

Follow these steps to re-assign the COM port number:

1. Select the COM port you want in order to change the COM port number.

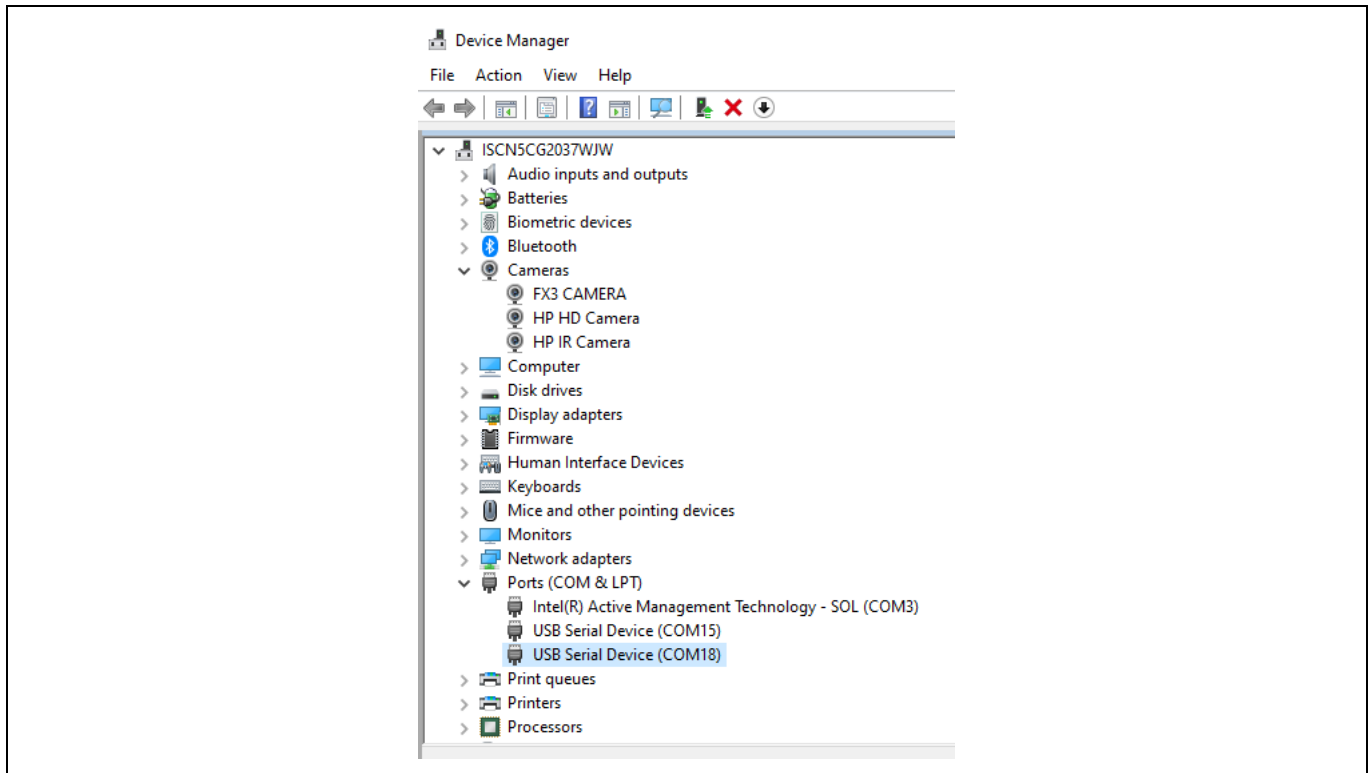

Figure 26 Device manager Cameras and Ports with FX3 camera and COM ports

2. Right-click on the COM port and select **Properties**

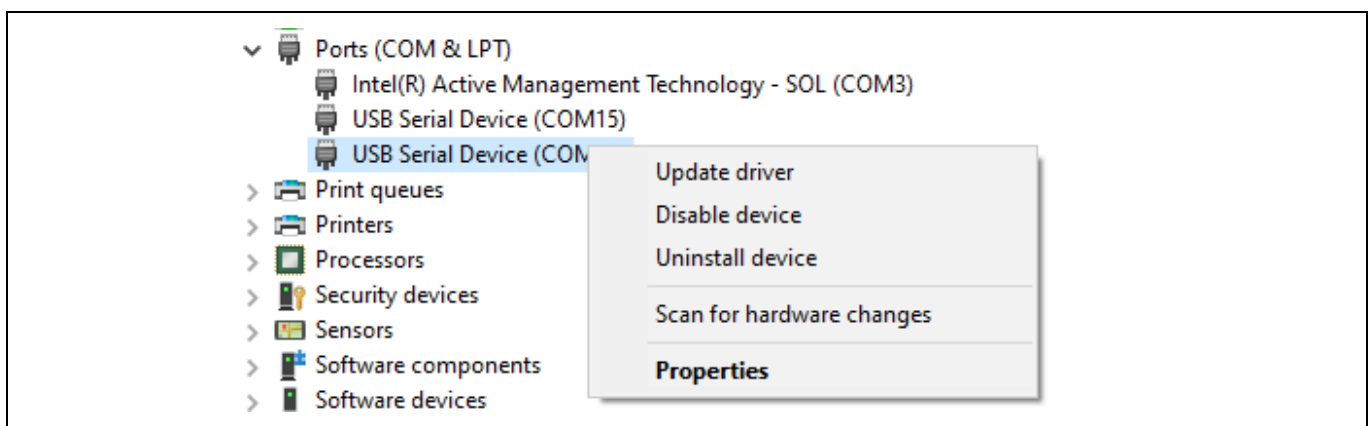

Figure 27 Select COM port properties

Troubleshooting

- Go to **Port Settings** and click on **Advanced**.

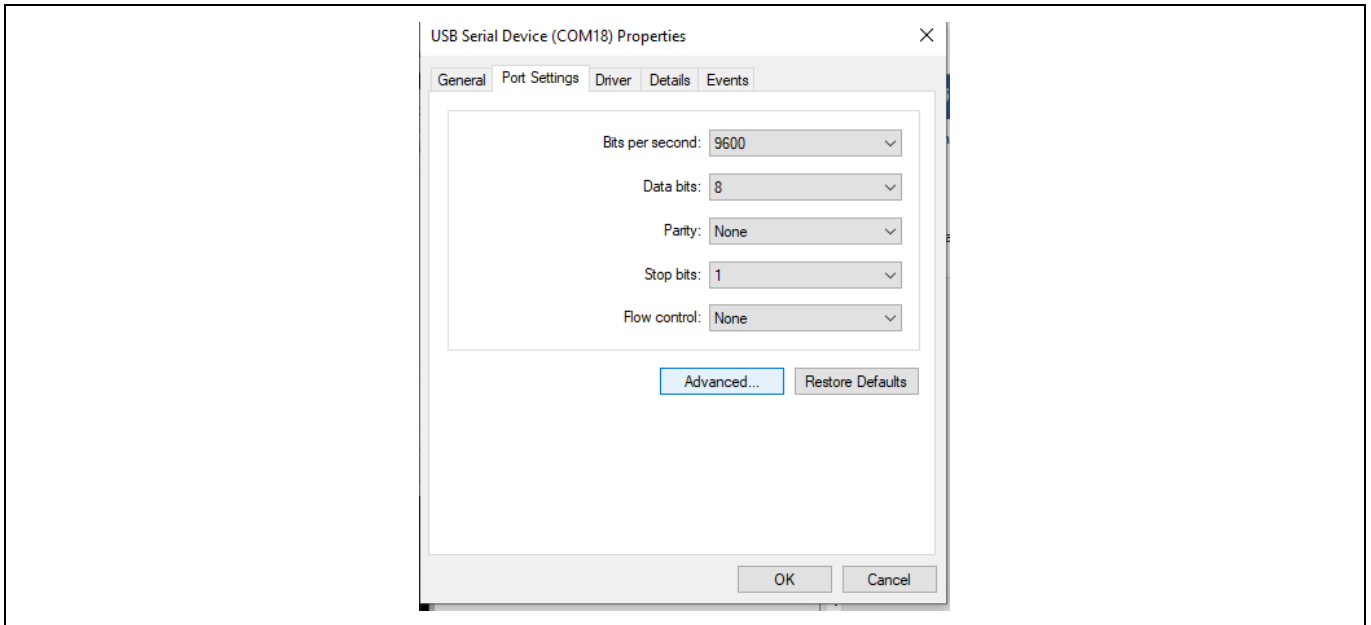

Figure 28 Port settings

- Select the COM port number less than 16 and click **OK**.

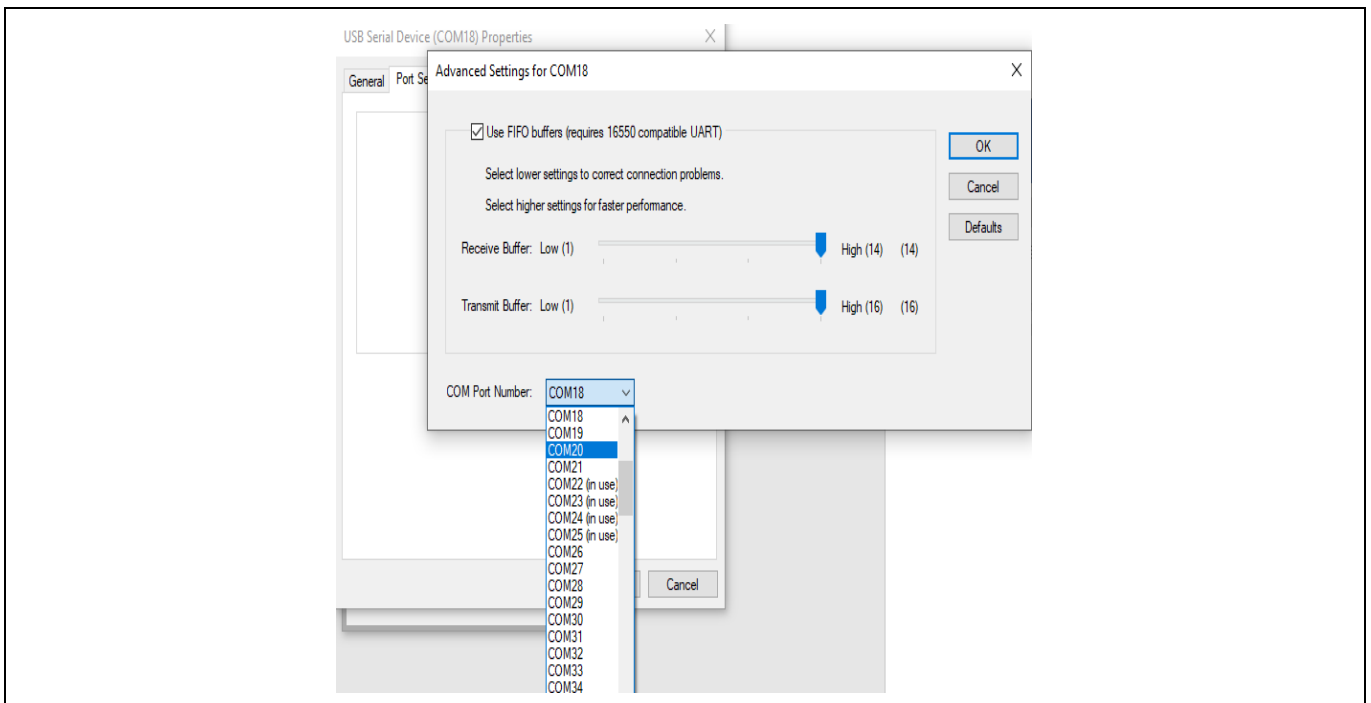

Figure 29 Selecting COM port value less than 16

- Disconnect and re-connect the USB cable, observe the COM port number (COM port number should be shown as assigned).

References

- [1] Product webpage: [EZ-USB™ FX3 webpage](#)
- [2] Kit webpage: [DEMO_FX3_LVDS_CAM01 webpage](#)
- [3] Datasheets: [EZ-USB™ FX3 datasheet](#)



Technical support

If you have any questions, create a support request on the Infineon [Technical Support](#) page.

Revision history

Revision history

Document revision	Date	Description of changes
**	2023-06-28	Initial release.
*A	2023-11-23	Replaced “SuperSpeed” with “USB 5 Gbps” in all instances across the document. Changed document category from Solution Demonstration to User Guides.
*B	2024-03-01	Added additional ISPN node in ECN.

Trademarks

All referenced product or service names and trademarks are the property of their respective owners.

Edition 2024-03-01

Published by

**Infineon Technologies AG
81726 Munich, Germany**

**©2024 Infineon Technologies AG.
All Rights Reserved.**

Do you have a question about this document?

Email: erratum@infineon.com

Document reference

002-38028 Rev. *B

IMPORTANT NOTICE

The information given in this document shall in no event be regarded as a guarantee of conditions or characteristics ("Beschaffheitsgarantie").

With respect to any examples, hints or any typical values stated herein and/or any information regarding the application of the product, Infineon Technologies hereby disclaims any and all warranties and liabilities of any kind, including without limitation warranties of non-infringement of intellectual property rights of any third party.

In addition, any information given in this document is subject to customer's compliance with its obligations stated in this document and any applicable legal requirements, norms and standards concerning customer's products and any use of the product of Infineon Technologies in customer's applications.

The data contained in this document is exclusively intended for technically trained staff. It is the responsibility of customer's technical departments to evaluate the suitability of the product for the intended application and the completeness of the product information given in this document with respect to such application.

For further information on the product, technology, delivery terms and conditions and prices please contact your nearest Infineon Technologies office (www.infineon.com).

WARNINGS

Due to technical requirements products may contain dangerous substances. For information on the types in question please contact your nearest Infineon Technologies office.

Except as otherwise explicitly approved by Infineon Technologies in a written document signed by authorized representatives of Infineon Technologies, Infineon Technologies' products may not be used in any applications where a failure of the product or any consequences of the use thereof can reasonably be expected to result in personal injury.