



CY7C1441AV25
CY7C1447AV25

**36-Mbit (1M × 36/512K × 72)
 Flow-Through SRAM**

Features

- Supports 133 MHz bus operations
- 1M × 36/512K × 72 common I/O
- 2.5 V core power supply
- 2.5 V I/O power supply
- Fast clock-to-output times
 - 6.5 ns (133 MHz version)
- Provide high performance 2-1-1-1 access rate
- User selectable burst counter supporting Intel® Pentium® interleaved or linear burst sequences
- Separate processor and controller address strobes
- Synchronous self timed write
- Asynchronous output enable
- CY7C1441AV25 available in Pb-free 165-ball FBGA package. CY7C1447AV25 available in non Pb-free 209-ball FBGA package.
- JTAG boundary scan for FBGA package
- ZZ sleep mode option

Functional Description

The CY7C1441AV25/CY7C1447AV25 are 2.5 V, 1M × 36/512K × 72 Synchronous Flow-Through SRAMs, designed to interface with high speed microprocessors with minimum glue logic. Maximum access delay from clock rise is 6.5 ns (133 MHz version). A 2-bit on-chip counter captures the first address in a burst and increments the address automatically for the rest of the burst access. All synchronous inputs are gated by registers controlled by a positive edge-triggered Clock Input (CLK). The synchronous inputs include all addresses, all data inputs, address pipelining Chip Enable (CE₁), depth expansion Chip Enables (CE₂ and CE₃), Burst Control inputs (ADSC, ADSP, and ADV), Write Enables (BW_x and BWE), and Global Write (GW). Asynchronous inputs include the Output Enable (OE) and the ZZ pin.

The CY7C1441AV25/CY7C1447AV25 allows either interleaved or linear burst sequences, selected by the MODE input pin. A HIGH selects an interleaved burst sequence and a LOW selects a linear burst sequence. Burst accesses can be initiated with the Processor Address Strobe (ADSP) or the cache Controller Address Strobe (ADSC) inputs. Address advancement is controlled by the Address Advancement (ADV) input.

Addresses and chip enables are registered at rising edge of clock when either ADSP or ADSC are active. Subsequent burst addresses can be internally generated as controlled by the ADV.

The CY7C1441AV25/CY7C1447AV25 operates from a +2.5 V core power supply while all outputs may operate with either a +2.5 V supply. All inputs and outputs are JEDEC-standard JESD8-5 compatible.

For a complete list of related documentation, click [here](#).

Selection Guide

Description	133 MHz	Unit
Maximum Access Time	6.5	ns
Maximum Operating Current	270	mA
Maximum CMOS Standby Current	120	mA

Logic Block Diagram – CY7C1441AV25

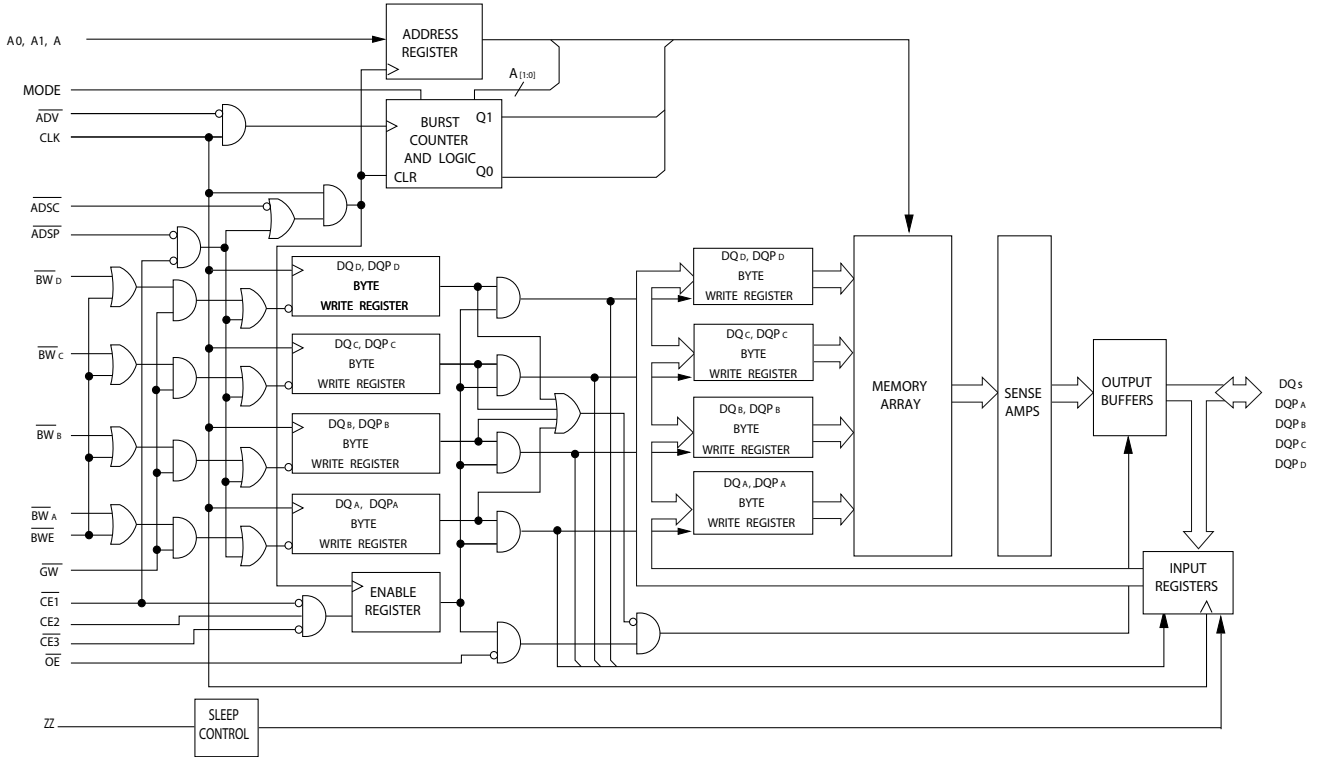

Logic Block Diagram – CY7C1447AV25

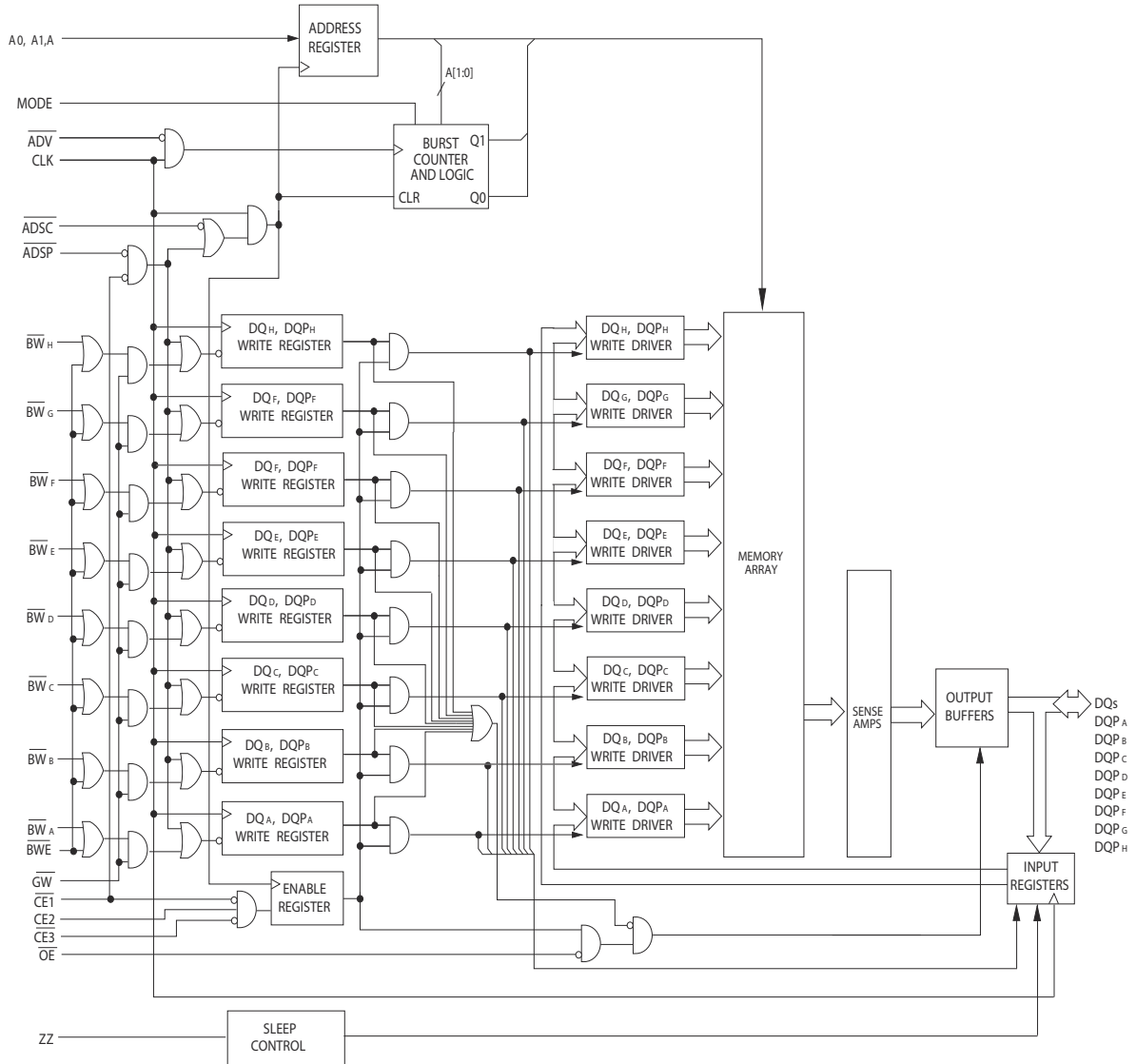

Contents

Pin Configurations	5	Identification Register Definitions	18
Pin Definitions	7	Scan Register Sizes	18
Functional Overview	8	Identification Codes	18
Single Read Accesses	8	Boundary Scan Order	19
Single Write Accesses Initiated by $\overline{\text{ADSP}}$	8	Boundary Scan Order	20
Single Write Accesses Initiated by $\overline{\text{ADSC}}$	8	Maximum Ratings	21
Burst Sequences	9	Operating Range	21
Sleep Mode	9	Electrical Characteristics	21
Interleaved Burst Address Table	9	Capacitance	22
Linear Burst Address Table	9	Thermal Resistance	22
ZZ Mode Electrical Characteristics	9	AC Test Loads and Waveforms	22
Truth Table	10	Switching Characteristics	23
Partial Truth Table for Read/Write	11	Timing Diagrams	24
Partial Truth Table for Read/Write	11	Ordering Information	28
IEEE 1149.1 Serial Boundary Scan (JTAG)	12	Ordering Code Definitions	28
Disabling the JTAG Feature	12	Package Diagrams	29
Test Access Port (TAP)	12	Acronyms	31
Performing a TAP Reset	12	Document Conventions	31
TAP Registers	12	Units of Measure	31
TAP Instruction Set	12	Document History Page	32
Tap Controller State Diagram	14	Sales, Solutions, and Legal Information	33
Tap Controller Block Diagram	15	Worldwide Sales and Design Support	33
TAP Timing	15	Products	33
TAP AC Switching Characteristics	16	PSoC® Solutions	33
2.5 V TAP AC Test Conditions	17	Cypress Developer Community	33
2.5 V TAP AC Output Load Equivalent	17	Technical Support	33
TAP DC Electrical Characteristics and Operating Conditions	17		

Pin Configurations

Figure 1. 165-ball FBGA (15 × 17 × 1.4 mm) pinout

CY7C1441AV25 (1M × 36)

	1	2	3	4	5	6	7	8	9	10	11
A	NC/288M	A	\overline{CE}_1	\overline{BW}_C	\overline{BW}_B	\overline{CE}_3	\overline{BWE}	\overline{ADSC}	\overline{ADV}	A	NC
B	NC/144M	A	CE_2	\overline{BW}_D	\overline{BW}_A	CLK	\overline{GW}	\overline{OE}	\overline{ADSP}	A	NC/576M
C	DQP _C	NC	V _{DDQ}	V _{SS}	V _{SS}	V _{SS}	V _{SS}	V _{SS}	V _{DDQ}	NC/1G	DQP _B
D	DQ _C	DQ _C	V _{DDQ}	V _{DD}	V _{SS}	V _{SS}	V _{SS}	V _{DD}	V _{DDQ}	DQ _B	DQ _B
E	DQ _C	DQ _C	V _{DDQ}	V _{DD}	V _{SS}	V _{SS}	V _{SS}	V _{DD}	V _{DDQ}	DQ _B	DQ _B
F	DQ _C	DQ _C	V _{DDQ}	V _{DD}	V _{SS}	V _{SS}	V _{SS}	V _{DD}	V _{DDQ}	DQ _B	DQ _B
G	DQ _C	DQ _C	V _{DDQ}	V _{DD}	V _{SS}	V _{SS}	V _{SS}	V _{DD}	V _{DDQ}	DQ _B	DQ _B
H	NC	NC	NC	V _{DD}	V _{SS}	V _{SS}	V _{SS}	V _{DD}	NC	NC	ZZ
J	DQ _D	DQ _D	V _{DDQ}	V _{DD}	V _{SS}	V _{SS}	V _{SS}	V _{DD}	V _{DDQ}	DQ _A	DQ _A
K	DQ _D	DQ _D	V _{DDQ}	V _{DD}	V _{SS}	V _{SS}	V _{SS}	V _{DD}	V _{DDQ}	DQ _A	DQ _A
L	DQ _D	DQ _D	V _{DDQ}	V _{DD}	V _{SS}	V _{SS}	V _{SS}	V _{DD}	V _{DDQ}	DQ _A	DQ _A
M	DQ _D	DQ _D	V _{DDQ}	V _{DD}	V _{SS}	V _{SS}	V _{SS}	V _{DD}	V _{DDQ}	DQ _A	DQ _A
N	DQP _D	NC	V _{DDQ}	V _{SS}	NC	A	NC	V _{SS}	V _{DDQ}	NC	DQP _A
P	NC	NC/72M	A	A	TDI	A1	TDO	A	A	A	A
R	MODE	A	A	A	TMS	A0	TCK	A	A	A	A

Pin Configurations (continued)

Figure 2. 209-ball FBGA (14 × 22 × 1.76 mm) pinout

CY7C1447AV25 (512K × 72)

	1	2	3	4	5	6	7	8	9	10	11
A	DQ _G	DQ _G	A	CE ₂	$\overline{\text{ADSP}}$	$\overline{\text{ADSC}}$	$\overline{\text{ADV}}$	$\overline{\text{CE}}_3$	A	DQ _B	DQ _B
B	DQ _G	DQ _G	$\overline{\text{BWS}}_C$	$\overline{\text{BWS}}_G$	NC/288M	$\overline{\text{BW}}$	A	$\overline{\text{BWS}}_B$	$\overline{\text{BWS}}_F$	DQ _B	DQ _B
C	DQ _G	DQ _G	$\overline{\text{BWS}}_H$	$\overline{\text{BWS}}_D$	NC/144M	$\overline{\text{CE}}_1$	NC/576M	$\overline{\text{BWS}}_E$	$\overline{\text{BWS}}_A$	DQ _B	DQ _B
D	DQ _G	DQ _G	V _{SS}	NC	NC/1G	$\overline{\text{OE}}$	$\overline{\text{GW}}$	NC	V _{SS}	DQ _B	DQ _B
E	DQP _G	DQP _C	V _{DDQ}	V _{DDQ}	V _{DD}	V _{DD}	V _{DD}	V _{DDQ}	V _{DDQ}	DQP _F	DQP _B
F	DQ _C	DQ _C	V _{SS}	V _{SS}	V _{SS}	NC	V _{SS}	V _{SS}	V _{SS}	DQ _F	DQ _F
G	DQ _C	DQ _C	V _{DDQ}	V _{DDQ}	V _{DD}	NC	V _{DD}	V _{DDQ}	V _{DDQ}	DQ _F	DQ _F
H	DQ _C	DQ _C	V _{SS}	V _{SS}	V _{SS}	NC	V _{SS}	V _{SS}	V _{SS}	DQ _F	DQ _F
J	DQ _C	DQ _C	V _{DDQ}	V _{DDQ}	V _{DD}	NC	V _{DD}	V _{DDQ}	V _{DDQ}	DQ _F	DQ _F
K	NC	NC	CLK	NC	V _{SS}	V _{SS}	V _{SS}	NC	NC	NC	NC
L	DQ _H	DQ _H	V _{DDQ}	V _{DDQ}	V _{DD}	NC	V _{DD}	V _{DDQ}	V _{DDQ}	DQ _A	DQ _A
M	DQ _H	DQ _H	V _{SS}	V _{SS}	V _{SS}	NC	V _{SS}	V _{SS}	V _{SS}	DQ _A	DQ _A
N	DQ _H	DQ _H	V _{DDQ}	V _{DDQ}	V _{DD}	NC	V _{DD}	V _{DDQ}	V _{DDQ}	DQ _A	DQ _A
P	DQ _H	DQ _H	V _{SS}	V _{SS}	V _{SS}	ZZ	V _{SS}	V _{SS}	V _{SS}	DQ _A	DQ _A
R	DQP _D	DQP _H	V _{DDQ}	V _{DDQ}	V _{DD}	V _{DD}	V _{DD}	V _{DDQ}	V _{DDQ}	DQP _A	DQP _E
T	DQ _D	DQ _D	V _{SS}	NC	NC	MODE	NC	NC	V _{SS}	DQ _E	DQ _E
U	DQ _D	DQ _D	NC/72M	A	A	A	A	A	A	DQ _E	DQ _E
V	DQ _D	DQ _D	A	A	A	A1	A	A	A	DQ _E	DQ _E
W	DQ _D	DQ _D	TMS	TDI	A	A0	A	TDO	TCK	DQ _E	DQ _E

Pin Definitions

Name	I/O	Description
A ₀ , A ₁ , A	Input-Synchronous	Address Inputs. Used to select one of the address locations. Sampled at the rising edge of the CLK if ADSP or ADSC is active LOW, and CE ₁ , CE ₂ , and CE ₃ are sampled active. A _[1:0] feed the 2-bit counter.
\overline{BW}_A , \overline{BW}_B , \overline{BW}_C , \overline{BW}_D , \overline{BW}_E , \overline{BW}_F , \overline{BW}_G , \overline{BW}_H	Input-Synchronous	Byte Write Select Inputs, Active LOW. Qualified with \overline{BWE} to conduct byte writes to the SRAM. Sampled on the rising edge of CLK.
\overline{GW}	Input-Synchronous	Global Write Enable Input, Active LOW. When asserted LOW on the rising edge of CLK, a global write is conducted (ALL bytes are written, regardless of the values on \overline{BW}_x and \overline{BWE}).
CLK	Input-Clock	Clock Input. Used to capture all synchronous inputs to the device. Also used to increment the burst counter when \overline{ADV} is asserted LOW during a burst operation.
\overline{CE}_1	Input-Synchronous	Chip Enable 1 Input, Active LOW. Sampled on the rising edge of CLK. Used in conjunction with CE ₂ and CE ₃ to select or deselect the device. ADSP is ignored if CE ₁ is HIGH. CE ₁ is sampled only when a new external address is loaded.
CE ₂	Input-Synchronous	Chip Enable 2 Input, Active HIGH. Sampled on the rising edge of CLK. Used in conjunction with \overline{CE}_1 and \overline{CE}_3 to select or deselect the device. CE ₂ is sampled only when a new external address is loaded.
\overline{CE}_3	Input-Synchronous	Chip Enable 3 Input, Active LOW. Sampled on the rising edge of CLK. Used in conjunction with \overline{CE}_1 and CE ₂ to select or deselect the device. CE ₃ is sampled only when a new external address is loaded.
\overline{OE}	Input-Asynchronous	Output Enable, Asynchronous Input, Active LOW. Controls the direction of the I/O pins. When LOW, the I/O pins behave as outputs. When deasserted HIGH, I/O pins are tri-stated and act as input data pins. \overline{OE} is masked during the first clock of a read cycle when emerging from a deselected state.
\overline{ADV}	Input-Synchronous	Advance Input Signal. Sampled on the rising edge of CLK. When asserted, it automatically increments the address in a burst cycle.
\overline{ADSP}	Input-Synchronous	Address Strobe from Processor. Sampled on the rising edge of CLK, active LOW. When asserted LOW, addresses presented to the device are captured in the address registers. A _[1:0] are also loaded into the burst counter. When \overline{ADSP} and \overline{ADSC} are both asserted, only \overline{ADSP} is recognized. \overline{ADSP} is ignored when \overline{CE}_1 is deasserted HIGH.
\overline{ADSC}	Input-Synchronous	Address Strobe from Controller. Sampled on the rising edge of CLK, active LOW. When asserted LOW, addresses presented to the device are captured in the address registers. A _[1:0] are also loaded into the burst counter. When \overline{ADSP} and \overline{ADSC} are both asserted, only \overline{ADSP} is recognized.
\overline{BWE}	Input-Synchronous	Byte Write Enable Input, Active LOW. Sampled on the rising edge of CLK. This signal must be asserted LOW to conduct a byte write.
ZZ	Input-Asynchronous	ZZ Sleep Input, Active HIGH. When asserted HIGH places the device in a non time-critical "sleep" condition with data integrity preserved. For normal operation, this pin must be LOW or left floating. ZZ pin has an internal pull down.
DQ _s	I/O-Synchronous	Bidirectional Data I/O Lines. As inputs, they feed into an on-chip data register that is triggered by the rising edge of CLK. As outputs, they deliver the data contained in the memory location specified by the addresses presented during the previous clock rise of the read cycle. The direction of the pins is controlled by \overline{OE} . When \overline{OE} is asserted LOW, the pins behave as outputs. When HIGH, DQ _s and DQP _x are placed in a tri-state condition. The outputs are automatically tri-stated during the data portion of a write sequence, during the first clock when emerging from a deselected state, and when the device is deselected, regardless of the state of \overline{OE} .
DQP _x	I/O-Synchronous	Bidirectional Data Parity I/O Lines. Functionally, these signals are identical to DQ _s . During write sequences, DQP _x is controlled by \overline{BW}_x correspondingly.
MODE	Input-Static	Selects Burst Order. When tied to GND selects linear burst sequence. When tied to V _{DD} or left floating selects interleaved burst sequence. This is a strap pin and should remain static during device operation. Mode pin has an internal pull up.

Pin Definitions (continued)

Name	I/O	Description
V _{DD}	Power Supply	Power Supply Inputs to the Core of the Device.
V _{DDQ}	I/O Power Supply	Power Supply for I/O Circuitry.
V _{SS}	Ground	Ground for the Core of the Device.
V _{SSQ}	I/O Ground	Ground for I/O Circuitry.
TDO	JTAG Serial Output Synchronous	Serial Data-Out to the JTAG Circuit. Delivers data on the negative edge of TCK. If the JTAG feature is not utilized, this pin should be left unconnected.
TDI	JTAG Serial Input Synchronous	Serial Data-In to the JTAG Circuit. Sampled on the rising edge of TCK. If the JTAG feature is not utilized, this pin can be left floating or connected to V _{DD} through a pull up resistor.
TMS	JTAG Serial Input Synchronous	Serial Data-In to the JTAG Circuit. Sampled on the rising edge of TCK. If the JTAG feature is not utilized, this pin can be disconnected or connected to V _{DD} .
TCK	JTAG-Clock	Clock Input to the JTAG Circuitry. If the JTAG feature is not utilized, this pin must be connected to V _{SS} .
NC	–	No Connects. Not internally connected to the die.
NC/72M, NC/144M, NC/288M, NC/576M, NC/1G	–	No Connects. Not internally connected to the die. NC/72M, NC/144M, NC/288M, NC/576M, and NC/1G are address expansion pins and are not internally connected to the die.

Functional Overview

All synchronous inputs pass through input registers controlled by the rising edge of the clock. Maximum access delay from the clock rise (t_{CDV}) is 6.5 ns (133 MHz device).

The CY7C1441AV25/CY7C1447AV25 supports secondary cache in systems utilizing either a linear or interleaved burst sequence. The interleaved burst order supports Pentium and i486™ processors. The linear burst sequence is suited for processors that utilize a linear burst sequence. The burst order is user selectable and is determined by sampling the MODE input. Accesses are initiated with either ADSP or ADSC. Address advancement through the burst sequence is controlled by the ADV input. A two-bit on-chip wraparound burst counter captures the first address in a burst sequence and automatically increments the address for the rest of the burst access.

Byte write operations are qualified with the Byte Write Enable (BWE) and Byte Write Select (BW_x) inputs. A Global Write Enable (GW) overrides all byte write inputs and writes data to all four bytes. All writes are simplified with on-chip synchronous self timed write circuitry.

Three synchronous chip selects (\overline{CE}_1 , CE₂, \overline{CE}_3) and an asynchronous output enable (OE) provide for easy bank selection and output tri-state control. ADSP is ignored if \overline{CE}_1 is HIGH.

Single Read Accesses

A single read access is initiated when the following conditions are satisfied at clock rise: (1) \overline{CE}_1 , CE₂, and \overline{CE}_3 are all asserted

active and (2) \overline{ADSP} or \overline{ADSC} is asserted LOW (if the access is initiated by ADSC, the write inputs must be deasserted during this first cycle). The address presented to the address inputs is latched into the address register and the burst counter or control logic and presented to the memory core. If the \overline{OE} input is asserted LOW, the requested data is available as the data outputs a maximum to t_{CDV} after clock rise. ADSP is ignored if \overline{CE}_1 is HIGH.

Single Write Accesses Initiated by \overline{ADSP}

This access is initiated when the following conditions are satisfied at clock rise: (1) \overline{CE}_1 , CE₂, \overline{CE}_3 are all asserted active and (2) ADSP is asserted LOW. The addresses presented are loaded into the address register and the burst inputs (GW, BWE, and BW_x) are ignored during this first clock cycle. If the write inputs are asserted active (see Truth Table on page 10 for appropriate states that indicate a write) on the next clock rise, the appropriate data is latched and written into the device. Byte writes are allowed. All I/Os are tri-stated during a byte write. Because this is a common I/O device, the asynchronous OE input signal must be deasserted and the I/Os must be tri-stated prior to the presentation of data to DQs. As a safety precaution, the data lines are tri-stated when a write cycle is detected, regardless of the state of OE.

Single Write Accesses Initiated by \overline{ADSC}

This write access is initiated when the following conditions are satisfied at clock rise: (1) \overline{CE}_1 , CE₂, and \overline{CE}_3 are all asserted active, (2) ADSC is asserted LOW, (3) ADSP is deasserted

HIGH, and (4) the write input signals (\overline{GW} , \overline{BWE} , and \overline{BW}_X) indicate a write access. ADSC is ignored if ADSP is active LOW.

The addresses presented are loaded into the address register and the burst counter or control logic and delivered to the memory core. The information presented to DQ_S is written into the specified address location. Byte writes are allowed. All I/Os are tri-stated when a write is detected, even a byte write. Because this is a common I/O device, the asynchronous OE input signal must be deasserted and the I/Os must be tri-stated prior to the presentation of data to DQs. As a safety precaution, the data lines are tri-stated when a write cycle is detected, regardless of the state of OE.

Burst Sequences

The CY7C1441AV25/CY7C1447AV25 provides an on-chip two-bit wraparound burst counter inside the SRAM. The burst counter is fed by $A_{[1:0]}$, and can follow either a linear or interleaved burst order. The burst order is determined by the state of the MODE input. A LOW on MODE selects a linear burst sequence. A HIGH on MODE selects an interleaved burst order. Leaving MODE unconnected causes the device to default to a interleaved burst sequence.

Sleep Mode

The ZZ input pin is an asynchronous input. Asserting ZZ places the SRAM in a power conservation sleep mode. Two clock cycles are required to enter into or exit from this sleep mode. When in this mode, data integrity is guaranteed. Accesses pending when entering the sleep mode are not considered valid nor is the completion of the operation guaranteed. The device must be

deselected prior to entering the sleep mode. \overline{CE}_1 , CE_2 , \overline{CE}_3 , ADSP, and ADSC must remain inactive for the duration of t_{ZZREC} after the ZZ input returns LOW.

Interleaved Burst Address Table

(MODE = Floating or V_{DD})

First Address A1:A0	Second Address A1:A0	Third Address A1:A0	Fourth Address A1:A0
00	01	10	11
01	00	11	10
10	11	00	01
11	10	01	00

Linear Burst Address Table

(MODE = GND)

First Address A1:A0	Second Address A1:A0	Third Address A1:A0	Fourth Address A1:A0
00	01	10	11
01	10	11	00
10	11	00	01
11	00	01	10

ZZ Mode Electrical Characteristics

Parameter	Description	Test Conditions	Min	Max	Unit
I_{DDZZ}	Sleep mode standby current	$ZZ \geq V_{DD} - 0.2 V$	–	100	mA
t_{ZZS}	Device operation to ZZ	$ZZ \geq V_{DD} - 0.2 V$	–	$2t_{CYC}$	ns
t_{ZZREC}	ZZ recovery time	$ZZ \leq 0.2 V$	$2t_{CYC}$	–	ns
t_{ZZI}	ZZ active to sleep current	This parameter is sampled	–	$2t_{CYC}$	ns
t_{RZZI}	ZZ Inactive to exit sleep current	This parameter is sampled	0	–	ns

Truth Table

The truth table for CY7C1441AV25/CY7C1447AV25 follows. [1, 2, 3, 4, 5]

Cycle Description	Address Used	\overline{CE}_1	CE_2	\overline{CE}_3	ZZ	\overline{ADSP}	\overline{ADSC}	\overline{ADV}	\overline{WRITE}	\overline{OE}	CLK	DQ
Deselected Cycle, Power Down	None	H	X	X	L	X	L	X	X	X	L-H	Tri-State
Deselected Cycle, Power Down	None	L	L	X	L	L	X	X	X	X	L-H	Tri-State
Deselected Cycle, Power Down	None	L	X	H	L	L	X	X	X	X	L-H	Tri-State
Deselected Cycle, Power Down	None	L	L	X	L	H	L	X	X	X	L-H	Tri-State
Deselected Cycle, Power Down	None	X	X	X	L	H	L	X	X	X	L-H	Tri-State
Sleep Mode, Power Down	None	X	X	X	H	X	X	X	X	X	X	Tri-State
Read Cycle, Begin Burst	External	L	H	L	L	L	X	X	X	L	L-H	Q
Read Cycle, Begin Burst	External	L	H	L	L	L	X	X	X	H	L-H	Tri-State
Write Cycle, Begin Burst	External	L	H	L	L	H	L	X	L	X	L-H	D
Read Cycle, Begin Burst	External	L	H	L	L	H	L	X	H	L	L-H	Q
Read Cycle, Begin Burst	External	L	H	L	L	H	L	X	H	H	L-H	Tri-State
Read Cycle, Continue Burst	Next	X	X	X	L	H	H	L	H	L	L-H	Q
Read Cycle, Continue Burst	Next	X	X	X	L	H	H	L	H	H	L-H	Tri-State
Read Cycle, Continue Burst	Next	H	X	X	L	X	H	L	H	L	L-H	Q
Read Cycle, Continue Burst	Next	H	X	X	L	X	H	L	H	H	L-H	Tri-State
Write Cycle, Continue Burst	Next	X	X	X	L	H	H	L	L	X	L-H	D
Write Cycle, Continue Burst	Next	H	X	X	L	X	H	L	L	X	L-H	D
Read Cycle, Suspend Burst	Current	X	X	X	L	H	H	H	H	L	L-H	Q
Read Cycle, Suspend Burst	Current	X	X	X	L	H	H	H	H	H	L-H	Tri-State
Read Cycle, Suspend Burst	Current	H	X	X	L	X	H	H	H	L	L-H	Q
Read Cycle, Suspend Burst	Current	H	X	X	L	X	H	H	H	H	L-H	Tri-State
Write Cycle, Suspend Burst	Current	X	X	X	L	H	H	H	L	X	L-H	D
Write Cycle, Suspend Burst	Current	H	X	X	L	X	H	H	L	X	L-H	D

Notes

- X = "Don't Care." H = Logic HIGH, L = Logic LOW.
- \overline{WRITE} = L when any one or more Byte Write enable signals and $\overline{BWE} = L$ or $\overline{GW} = L$. \overline{WRITE} = H when all Byte write enable signals, \overline{BWE} , $\overline{GW} = H$.
- The DQ pins are controlled by the current cycle and the OE signal. OE is asynchronous and is not sampled with the clock.
- The SRAM always initiates a read cycle when \overline{ADSP} is asserted, regardless of the state of \overline{GW} , \overline{BWE} , or \overline{BW}_x . Writes may occur only on subsequent clocks after the \overline{ADSP} or with the assertion of \overline{ADSC} . As a result, OE must be driven HIGH prior to the start of the write cycle to allow the outputs to tri-state. OE is a don't care for the remainder of the write cycle.
- \overline{OE} is asynchronous and is not sampled with the clock rise. It is masked internally during write cycles. During a read cycle all data bits are Tri-State when \overline{OE} is inactive or when the device is deselected, and all data bits behave as output when OE is active (LOW).

Partial Truth Table for Read/Write

The partial truth table for read/write for CY7C1441AV25 follows. [6, 7]

Function (CY7C1441AV25)	\overline{GW}	\overline{BWE}	\overline{BW}_D	\overline{BW}_C	\overline{BW}_B	\overline{BW}_A
Read	H	H	X	X	X	X
Read	H	L	H	H	H	H
Write Byte A (DQ _A , DQP _A)	H	L	H	H	H	L
Write Byte B (DQ _B , DQP _B)	H	L	H	H	L	H
Write Bytes A, B (DQ _A , DQ _B , DQP _A , DQP _B)	H	L	H	H	L	L
Write Byte C (DQ _C , DQP _C)	H	L	H	L	H	H
Write Bytes C, A (DQ _C , DQ _A , DQP _C , DQP _A)	H	L	H	L	H	L
Write Bytes C, B (DQ _C , DQ _B , DQP _C , DQP _B)	H	L	H	L	L	H
Write Bytes C, B, A (DQ _C , DQ _B , DQ _A , DQP _C , DQP _B , DQP _A)	H	L	H	L	L	L
Write Byte D (DQ _D , DQP _D)	H	L	L	H	H	H
Write Bytes D, A (DQ _D , DQ _A , DQP _D , DQP _A)	H	L	L	H	H	L
Write Bytes D, B (DQ _D , DQ _B , DQP _D , DQP _B)	H	L	L	H	L	H
Write Bytes D, B, A (DQ _D , DQ _B , DQ _A , DQP _D , DQP _B , DQP _A)	H	L	L	H	L	L
Write Bytes D, B (DQ _D , DQ _B , DQP _D , DQP _B)	H	L	L	L	H	H
Write Bytes D, B, A (DQ _D , DQ _C , DQ _A , DQP _D , DQP _C , DQP _A)	H	L	L	L	H	L
Write Bytes D, C, A (DQ _D , DQ _B , DQ _A , DQP _D , DQP _B , DQP _A)	H	L	L	L	L	H
Write All Bytes	H	L	L	L	L	L
Write All Bytes	L	X	X	X	X	X

Partial Truth Table for Read/Write

The partial truth table for read/write for CY7C1447AV25 follows. [6, 8]

Function (CY7C1447AV25)	\overline{GW}	\overline{BWE}	\overline{BW}_x
Read	H	H	X
Read	H	L	All $\overline{BW} = H$
Write Byte x – (DQ _x and DQP _x)	H	L	L
Write All Bytes	H	L	All $\overline{BW} = L$
Write All Bytes	L	X	X

Notes

6. X = "Don't Care." H = Logic HIGH, L = Logic LOW.
7. Table only lists a partial listing of the byte write combinations. Any combination of \overline{BW}_x is valid. Appropriate write is done based on which byte write is active.
8. \overline{BW}_x represents any byte write signal \overline{BW}_x . To enable any byte write \overline{BW}_x , a logic LOW signal should be applied at clock rise. Any number of byte writes can be enabled at the same time for any given write.

IEEE 1149.1 Serial Boundary Scan (JTAG)

The CY7C1441AV25/CY7C1447AV25 incorporates a serial boundary scan test access port (TAP). This part is fully compliant with 1149.1. The TAP operates using JEDEC-standard 2.5 V I/O logic level.

The CY7C1441AV25/CY7C1447AV25 contains a TAP controller, instruction register, boundary scan register, bypass register, and ID register.

Disabling the JTAG Feature

It is possible to operate the SRAM without using the JTAG feature. To disable the TAP controller, TCK must be tied LOW (V_{SS}) to prevent clocking of the device. TDI and TMS are internally pulled up and may be unconnected. They may alternately be connected to V_{DD} through a pull up resistor. TDO must be left unconnected. On power up, the device comes up in a reset state, which does not interfere with the operation of the device.

Test Access Port (TAP)

Test Clock (TCK)

The test clock is used only with the TAP controller. All inputs are captured on the rising edge of TCK. All outputs are driven from the falling edge of TCK.

Test Mode Select (TMS)

The TMS input is used to give commands to the TAP controller and is sampled on the rising edge of TCK. This ball can be left unconnected if the TAP is not used. The ball is pulled up internally, resulting in a logic HIGH level.

Test Data-In (TDI)

The TDI ball is used to serially input information into the registers and can be connected to the input of any of the registers. The register between TDI and TDO is chosen by the instruction that is loaded into the TAP instruction register. For information on loading the instruction register, see [Tap Controller State Diagram on page 14](#). TDI is internally pulled up and can be unconnected if the TAP is unused in an application. TDI is connected to the most significant bit (MSB) of any register.

Test Data-Out (TDO)

The TDO output ball is used to serially clock data out from the registers. The output is active depending on the current state of the TAP state machine (see [Identification Codes on page 18](#)). The output changes on the falling edge of TCK. TDO is connected to the least significant bit (LSB) of any register.

Performing a TAP Reset

A RESET is performed by forcing TMS HIGH (V_{DD}) for five rising edges of TCK. This RESET does not affect the operation of the SRAM and may be performed while the SRAM is operating.

At power up, the TAP is reset internally to ensure that TDO comes up in a High Z state.

TAP Registers

Registers are connected between the TDI and TDO balls and allow data to be scanned into and out of the SRAM test circuitry.

Only one register can be selected at a time through the instruction register. Data is serially loaded into the TDI ball on the rising edge of TCK. Data is output on the TDO ball on the falling edge of TCK.

Instruction Register

Three-bit instructions can be serially loaded into the instruction register. This register is loaded when it is placed between the TDI and TDO balls as shown in the [Tap Controller Block Diagram on page 15](#). On power up, the instruction register is loaded with the IDCODE instruction. It is also loaded with the IDCODE instruction if the controller is placed in a reset state as described in the previous section.

When the TAP controller is in the Capture-IR state, the two least significant bits are loaded with a binary '01' pattern to allow fault isolation of the board level serial test data path.

Bypass Register

To save time when serially shifting data through registers, it is sometimes advantageous to skip certain chips. The bypass register is a single-bit register that is placed between the TDI and TDO balls. This allows data to be shifted through the SRAM with minimal delay. The bypass register is set LOW (V_{SS}) when the BYPASS instruction is executed.

Boundary Scan Register

The boundary scan register is connected to all the input and bidirectional balls on the SRAM.

The boundary scan register is loaded with the contents of the RAM I/O ring when the TAP controller is in the Capture-DR state. It is then placed between the TDI and TDO balls when the controller is moved to the Shift-DR state. The EXTEST, SAMPLE/PRELOAD and SAMPLE Z instructions are used to capture the contents of the I/O ring.

The Boundary Scan Order tables show the order in which the bits are connected. Each bit corresponds to one of the bumps on the SRAM package. The MSB of the register is connected to TDI and the LSB is connected to TDO.

Identification (ID) Register

The ID register is loaded with a vendor specific, 32-bit code during the Capture-DR state when the IDCODE command is loaded in the instruction register. The IDCODE is hardwired into the SRAM and can be shifted out when the TAP controller is in the Shift-DR state. The ID register has a vendor code and other information described in the [Identification Register Definitions on page 18](#).

TAP Instruction Set

Overview

Eight different instructions are possible with the three bit instruction register. All combinations are listed in the [Identification Codes on page 18](#). Three of these instructions are listed as RESERVED and should not be used. The other five instructions are described in detail below.

Instructions are loaded into the TAP controller during the Shift-IR state when the instruction register is placed between TDI and TDO. During this state, instructions are shifted through the instruction register through the TDI and TDO balls. To execute

the instruction after it is shifted in, the TAP controller must be moved into the Update-IR state.

IDCODE

The IDCODE instruction causes a vendor specific, 32-bit code to be loaded into the instruction register. It also places the instruction register between the TDI and TDO balls and allows the IDCODE to be shifted out of the device when the TAP controller enters the Shift-DR state.

The IDCODE instruction is loaded into the instruction register on power up or whenever the TAP controller is given a test logic reset state.

SAMPLE Z

The SAMPLE Z instruction causes the boundary scan register to be connected between the TDI and TDO pins when the TAP controller is in a Shift-DR state. The SAMPLE Z command puts the output bus into a High Z state until the next command is given during the "Update IR" state.

SAMPLE/PRELOAD

SAMPLE/PRELOAD is a 1149.1 mandatory instruction. When the SAMPLE/PRELOAD instructions are loaded into the instruction register and the TAP controller is in the Capture-DR state, a snapshot of data on the inputs and output pins is captured in the boundary scan register.

The user must be aware that the TAP controller clock can only operate at a frequency up to 20 MHz, while the SRAM clock operates more than an order of magnitude faster. Because there is a large difference in the clock frequencies, it is possible that during the Capture-DR state, an input or output may undergo a transition. The TAP may then try to capture a signal while in transition (metastable state). This does not harm the device, but there is no guarantee as to the value that is captured. Repeatable results may not be possible.

To guarantee that the boundary scan register captures the correct value of a signal, the SRAM signal must be stabilized long enough to meet the TAP controller's capture setup plus hold times (t_{CS} and t_{CH}). The SRAM clock input might not be captured correctly if there is no way in a design to stop (or slow) the clock during a SAMPLE/PRELOAD instruction. If this is an issue, it is still possible to capture all other signals and simply ignore the value of the CK and \overline{CK} captured in the boundary scan register.

When the data is captured, it is possible to shift out the data by putting the TAP into the Shift-DR state. This places the boundary scan register between the TDI and TDO pins.

PRELOAD allows an initial data pattern to be placed at the latched parallel outputs of the boundary scan register cells prior to the selection of another boundary scan test operation.

The shifting of data for the SAMPLE and PRELOAD phases can occur concurrently when required – that is, while data captured is shifted out, the preloaded data can be shifted in.

BYPASS

When the BYPASS instruction is loaded in the instruction register and the TAP is placed in a Shift-DR state, the bypass register is placed between the TDI and TDO pins. The advantage of the BYPASS instruction is that it shortens the boundary scan path when multiple devices are connected together on a board.

EXTEST

The EXTEST instruction enables the preloaded data to be driven out through the system output pins. This instruction also selects the boundary scan register to be connected for serial access between the TDI and TDO in the Shift-DR controller state.

EXTEST OUTPUT BUS TRI-STATE

IEEE Standard 1149.1 mandates that the TAP controller be able to put the output bus into a tri-state mode.

The boundary scan register has a special bit located at bit #138 (for 209-ball FBGA package). When this scan cell, called the "extest output bus tri-state", is latched into the preload register during the Update-DR state in the TAP controller, it directly controls the state of the output (Q-bus) pins when the EXTEST is entered as the current instruction. When HIGH, it enables the output buffers to drive the output bus. When LOW, this bit places the output bus into a High Z condition.

This bit can be set by entering the SAMPLE/PRELOAD, or EXTEST command and then shifting the desired bit into that cell during the Shift-DR state. During Update-DR, the value loaded into that shift register cell latches into the preload register. When the EXTEST instruction is entered, this bit directly controls the output Q-bus pins. Note that this bit is preset HIGH to enable the output when the device is powered up and also when the TAP controller is in the Test-Logic-Reset" state.

Reserved

These instructions are not implemented but are reserved for future use. Do not use these instructions.

TAP Controller State Diagram

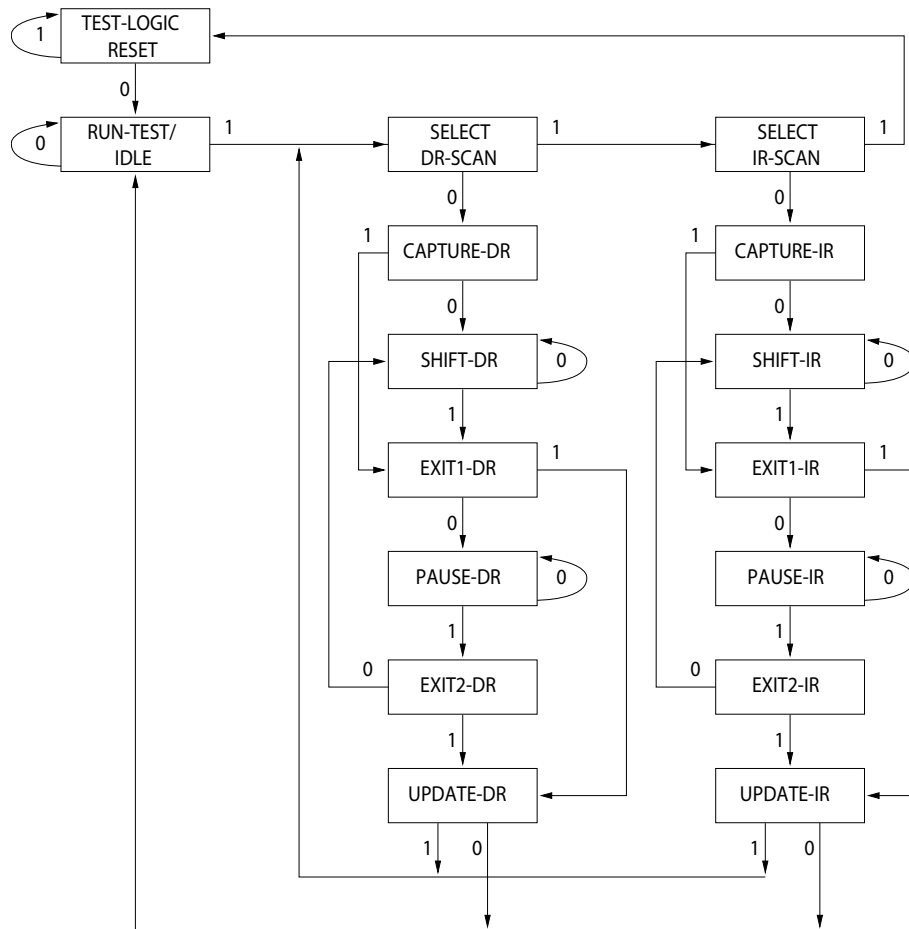

The 0/1 next to each state represents the value of TMS at the rising edge of TCK.

TAP Controller Block Diagram

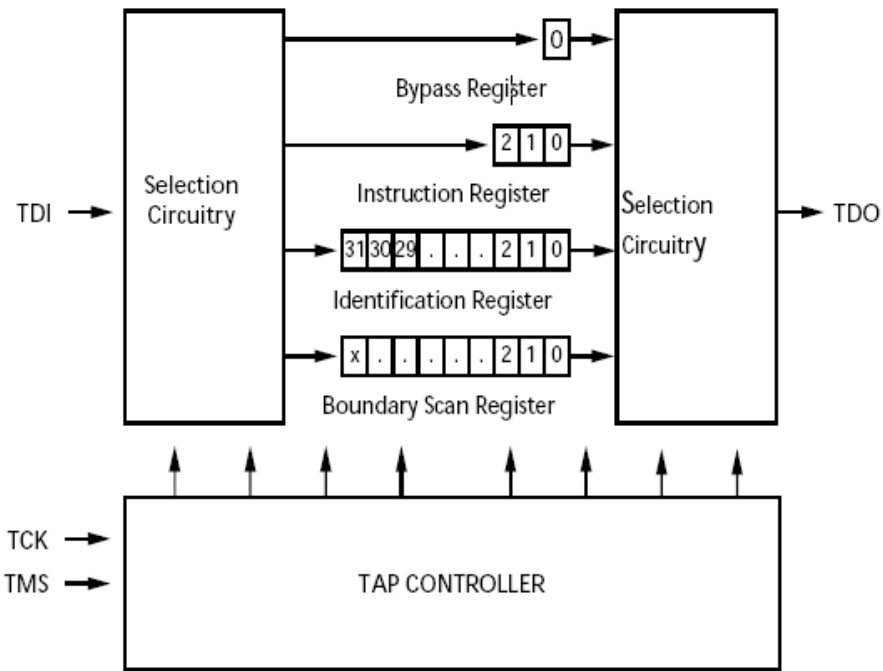

TAP Timing

Figure 3. TAP Timing

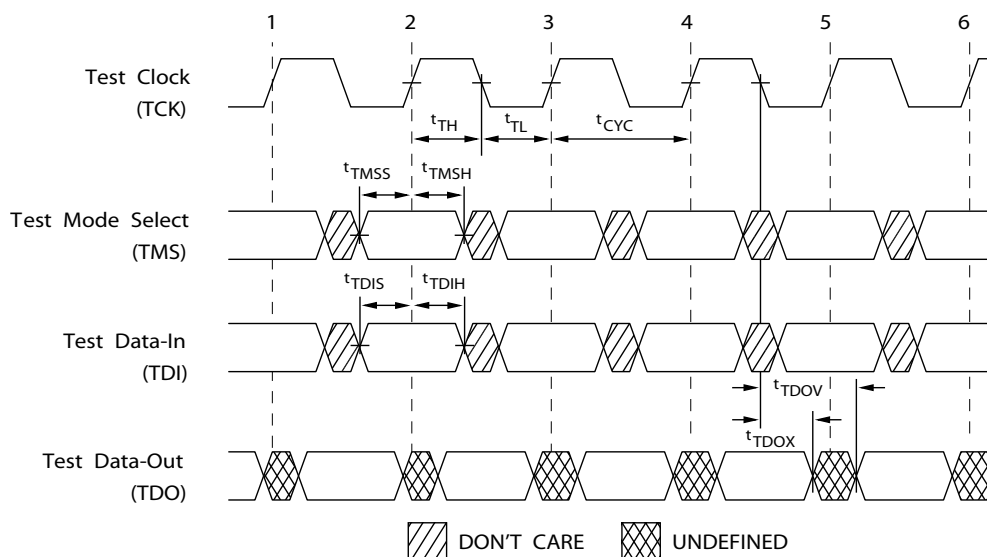

TAP AC Switching Characteristics

Over the Operating Range

Parameter ^[9, 10]	Parameter	Min	Max	Unit
Clock				
t_{TCYC}	TCK Clock Cycle Time	50	–	ns
t_{TF}	TCK Clock Frequency	–	20	MHz
t_{TH}	TCK Clock HIGH time	20	–	ns
t_{TL}	TCK Clock LOW time	20	–	ns
Output Times				
t_{TDOV}	TCK Clock LOW to TDO Valid	–	10	ns
t_{TDOX}	TCK Clock LOW to TDO Invalid	0	–	ns
Setup Times				
t_{TMSS}	TMS Setup to TCK Clock Rise	5	–	ns
t_{TDIS}	TDI Setup to TCK Clock Rise	5	–	ns
t_{CS}	Capture Setup to TCK Rise	5	–	ns
Hold Times				
t_{TMSh}	TMS Hold after TCK Clock Rise	5	–	ns
t_{TDIH}	TDI Hold after Clock Rise	5	–	ns
t_{CH}	Capture Hold after Clock Rise	5	–	ns

Notes

9. t_{CS} and t_{CH} refer to the setup and hold time requirements of latching data from the boundary scan register.
 10. Test conditions are specified using the load in TAP AC test Conditions. $t_R/t_F = 1$ ns.

2.5 V TAP AC Test Conditions

Input pulse levels V_{SS} to 2.5 V
 Input rise and fall time 1 ns
 Input timing reference levels 1.25 V
 Output reference levels 1.25 V
 Test load termination supply voltage 1.25 V

2.5 V TAP AC Output Load Equivalent

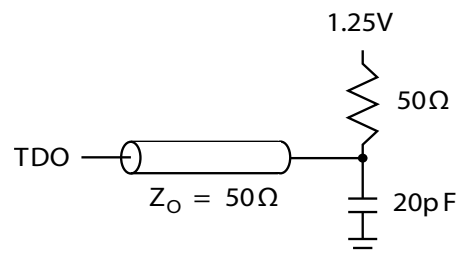

TAP DC Electrical Characteristics and Operating Conditions

($0\text{ }^{\circ}\text{C} < T_A < +70\text{ }^{\circ}\text{C}$; $V_{DD} = 2.5\text{ V} \pm 0.125\text{ V}$ unless otherwise noted)

Parameter ^[11]	Description	Description	Conditions	Min	Max	Unit
V_{OH1}	Output HIGH Voltage	$I_{OH} = -1.0\text{ mA}$	$V_{DDQ} = 2.5\text{ V}$	2.0	–	V
V_{OH2}	Output HIGH Voltage	$I_{OH} = -100\text{ }\mu\text{A}$	$V_{DDQ} = 2.5\text{ V}$	2.1	–	V
V_{OL1}	Output LOW Voltage	$I_{OL} = 1.0\text{ mA}$	$V_{DDQ} = 2.5\text{ V}$	–	0.4	V
V_{OL2}	Output LOW Voltage	$I_{OL} = 100\text{ }\mu\text{A}$	$V_{DDQ} = 2.5\text{ V}$	–	0.2	V
V_{IH}	Input HIGH Voltage		$V_{DDQ} = 2.5\text{ V}$	1.7	$V_{DD} + 0.3$	V
V_{IL}	Input LOW Voltage		$V_{DDQ} = 2.5\text{ V}$	-0.3	0.7	V
I_X	Input Load Current	$GND \leq V_{IN} \leq V_{DDQ}$		-5	5	μA

Note

11. All voltages referenced to V_{SS} (GND).

Identification Register Definitions

Instruction Field	Bit Configuration CY7C1441AV25 (1M × 36)	Bit Configuration CY7C1447AV25 (512K × 72)	Description
Revision Number (31:29)	000	000	Describes the version number.
Device Depth (28:24)	01011	01011	Reserved for internal use.
Architecture and Memory Type (23:18)	000001	000001	Defines memory type and architecture.
Bus Width and Density (17:12)	100111	110111	Defines width and density.
Cypress JEDEC ID Code (11:1)	00000110100	00000110100	Allows unique identification of SRAM vendor.
ID Register Presence Indicator (0)	1	1	Indicates the presence of an ID register.

Scan Register Sizes

Register Name	Bit Size (× 36)	Bit Size (× 72)
Instruction Bypass	3	3
Bypass	1	1
ID	32	32
Boundary Scan Order (165-ball FBGA package)	89	–
Boundary Scan Order (209-ball FBGA package)	–	138

Identification Codes

Instruction	Code	Description
EXTEST	000	Captures I/O ring contents.
IDCODE	001	Loads the ID register with the vendor ID code and places the register between TDI and TDO. This operation does not affect SRAM operations.
SAMPLE Z	010	Captures I/O ring contents. Places the boundary scan register between TDI and TDO. Forces all SRAM output drivers to a High Z state.
RESERVED	011	Do Not Use: This instruction is reserved for future use.
SAMPLE/PRELOAD	100	Captures I/O ring contents. Places the boundary scan register between TDI and TDO. Does not affect SRAM operation.
RESERVED	101	Do Not Use: This instruction is reserved for future use.
RESERVED	110	Do Not Use: This instruction is reserved for future use.
BYPASS	111	Places the bypass register between TDI and TDO. This operation does not affect SRAM operations.

Boundary Scan Order

165-ball FBGA [12, 13]

CY7C1441AV25 (1M × 36)

Bit #	Ball ID
1	N6
2	N7
3	N10
4	P11
5	P8
6	R8
7	R9
8	P9
9	P10
10	R10
11	R11
12	H11
13	N11
14	M11
15	L11
16	K11
17	J11
18	M10
19	L10
20	K10
21	J10
22	H9
23	H10
24	G11
25	F11

Bit #	Ball ID
26	E11
27	D11
28	G10
29	F10
30	E10
31	D10
32	C11
33	A11
34	B11
35	A10
36	B10
37	A9
38	B9
39	C10
40	A8
41	B8
42	A7
43	B7
44	B6
45	A6
46	B5
47	A5
48	A4
49	B4
50	B3

Bit #	Ball ID
51	A3
52	A2
53	B2
54	C2
55	B1
56	A1
57	C1
58	D1
59	E1
60	F1
61	G1
62	D2
63	E2
64	F2
65	G2
66	H1
67	H3
68	J1
69	K1
70	L1
71	M1
72	J2
73	K2
74	L2
75	M2

Bit #	Ball ID
76	N1
77	N2
78	P1
79	R1
80	R2
81	P3
82	R3
83	P2
84	R4
85	P4
86	N5
87	P6
88	R6
89	Internal

Notes

- 12. Balls which are NC (No Connect) are preset LOW.
- 13. Bit# 89 is preset HIGH.

Boundary Scan Order

209-ball FBGA [14, 15]

CY7C1447AV25 (512K × 72)

Bit #	Ball ID
1	W6
2	V6
3	U6
4	W7
5	V7
6	U7
7	T7
8	V8
9	U8
10	T8
11	V9
12	U9
13	P6
14	W11
15	W10
16	V11
17	V10
18	U11
19	U10
20	T11
21	T10
22	R11
23	R10
24	P11
25	P10
26	N11
27	N10
28	M11
29	M10
30	L11
31	L10
32	K11
33	M6
34	L6
35	J6

Bit #	Ball ID
36	F6
37	K8
38	K9
39	K10
40	J11
41	J10
42	H11
43	H10
44	G11
45	G10
46	F11
47	F10
48	E10
49	E11
50	D11
51	D10
52	C11
53	C10
54	B11
55	B10
56	A11
57	A10
58	C9
59	B9
60	A9
61	D7
62	C8
63	B8
64	A8
65	D8
66	C7
67	B7
68	A7
69	D6
70	G6

Bit #	Ball ID
71	H6
72	C6
73	B6
74	A6
75	A5
76	B5
77	C5
78	D5
79	D4
80	C4
81	A4
82	B4
83	C3
84	B3
85	A3
86	A2
87	A1
88	B2
89	B1
90	C2
91	C1
92	D2
93	D1
94	E1
95	E2
96	F2
97	F1
98	G1
99	G2
100	H2
101	H1
102	J2
103	J1
104	K1
105	N6

Bit #	Ball ID
106	K3
107	K4
108	K6
109	K2
110	L2
111	L1
112	M2
113	M1
114	N2
115	N1
116	P2
117	P1
118	R2
119	R1
120	T2
121	T1
122	U2
123	U1
124	V2
125	V1
126	W2
127	W1
128	T6
129	U3
130	V3
131	T4
132	T5
133	U4
134	V4
135	5W
136	5V
137	5U
138	Internal

Notes

- 14. Balls which are NC (No Connect) are preset LOW.
- 15. Bit# 138 is preset HIGH.

Maximum Ratings

Exceeding maximum ratings may impair the useful life of the device. These user guidelines are not tested.

Storage Temperature -65 °C to +150 °C
 Ambient Temperature
 with Power Applied -55 °C to +125 °C
 Supply Voltage on V_{DD} Relative to GND -0.3 V to +3.6 V
 Supply Voltage on V_{DDQ} Relative to GND -0.3 V to +V_{DD}
 DC Voltage Applied to Outputs
 in Tri-State -0.5 V to V_{DDQ} + 0.5 V

DC Input Voltage -0.5 V to V_{DD} + 0.5 V
 Current into Outputs (LOW) 20 mA
 Static Discharge Voltage
 (per MIL-STD-883, Method 3015) > 2001 V
 Latch Up Current > 200 mA

Operating Range

Range	Ambient Temperature	V _{DD}	V _{DDQ}
Industrial	-40 °C to +85 °C	2.5 V ± 5%	1.7 V to V _{DD}

Electrical Characteristics

Over the Operating Range

Parameter ^[16, 17]	Description	Test Conditions	Min	Max	Unit	
V _{DD}	Power Supply Voltage		2.375	2.625	V	
V _{DDQ}	I/O Supply Voltage	for 2.5 V I/O	2.375	2.625	V	
V _{OH}	Output HIGH Voltage	for 2.5 V I/O, I _{OH} = -1.0 mA	2.0	-	V	
V _{OL}	Output LOW Voltage	for 2.5 V I/O, I _{OL} = 1.0 mA	-	0.4	V	
V _{IH}	Input HIGH Voltage ^[16]	for 2.5 V I/O	1.7	V _{DD} + 0.3	V	
V _{IL}	Input LOW Voltage ^[16]	for 2.5 V I/O	-0.3	0.7	V	
I _X	Input Leakage Current except ZZ and MODE	GND ≤ V _I ≤ V _{DDQ}	-5	5	μA	
		Input Current of MODE	Input = V _{SS}	-30	-	μA
		Input = V _{DD}	-	5	μA	
		Input Current of ZZ	Input = V _{SS}	-5	-	μA
Input = V _{DD}	-	30	μA			
I _{OZ}	Output Leakage Current	GND ≤ V _I ≤ V _{DDQ} , Output Disabled	-5	5	μA	
I _{DD}	V _{DD} Operating Supply Current	V _{DD} = Max, I _{OUT} = 0 mA, f = f _{MAX} = 1/t _{CYC}	7.5 ns cycle, 133 MHz	-	270	mA
I _{SB1}	Automatic CE Power Down Current – TTL Inputs	Max V _{DD} , Device Deselected, V _{IN} ≥ V _{IH} or V _{IN} ≤ V _{IL} , f = f _{MAX} , Inputs Switching	7.5 ns cycle, 133 MHz	-	150	mA
I _{SB2}	Automatic CE Power Down Current – CMOS Inputs	Max V _{DD} , Device Deselected, V _{IN} ≥ V _{DD} - 0.3 V or V _{IN} ≤ 0.3 V, f = 0, Inputs Static	7.5 ns cycle, 133 MHz	-	120	mA
I _{SB3}	Automatic CE Power Down Current – CMOS Inputs	Max V _{DD} , Device Deselected, V _{IN} ≥ V _{DDQ} - 0.3 V or V _{IN} ≤ 0.3 V, f = f _{MAX} , Inputs Switching	7.5 ns cycle, 133 MHz	-	150	mA
I _{SB4}	Automatic CE Power Down Current – TTL Inputs	Max V _{DD} , Device Deselected, V _{IN} ≥ V _{DD} - 0.3 V or V _{IN} ≤ 0.3 V, f = 0, Inputs Static	7.5 ns cycle, 133 MHz	-	135	mA

Notes

16. Overshoot: V_{IH(AC)} < V_{DD} + 1.5 V (Pulse width less than t_{CYC}/2), undershoot: V_{IL(AC)} > -2 V (Pulse width less than t_{CYC}/2).
 17. T_{Power-up}: Assumes a linear ramp from V to V_{DD(min)} within 200 ms. During this time V_{IH} < V_{DD} and V_{DDQ} ≤ V_{DD}.

Capacitance

Parameter ^[18]	Description	Test Conditions	165-ball FBGA Max	209-ball FBGA Max	Unit
C _{IN}	Input capacitance	T _A = 25 °C, f = 1 MHz, V _{DD} = 2.5 V, V _{DDQ} = 2.5 V	7	5	pF
C _{CLK}	Clock input capacitance		7	5	pF
C _{I/O}	Input/Output capacitance		6	7	pF

Thermal Resistance

Parameter ^[18]	Description	Test Conditions	165-ball FBGA Package	209-ball FBGA Package	Unit
Θ _{JA}	Thermal resistance (junction to ambient)	Test conditions follow standard test methods and procedures for measuring thermal impedance, per EIA/JESD51.	20.8	25.31	°C/W
Θ _{JC}	Thermal resistance (junction to case)		3.2	4.48	°C/W

AC Test Loads and Waveforms

Figure 4. AC Test Loads and Waveforms

2.5 V I/O Test Load

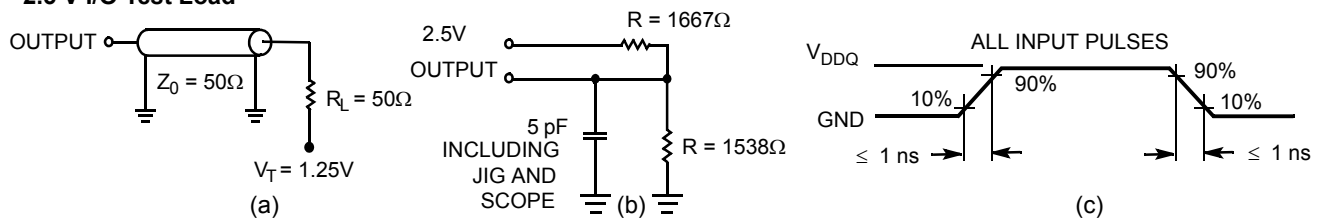

Note

18. Tested initially and after any design or process change that may affect these parameters.

Switching Characteristics

Over the Operating Range

Parameter ^[19, 20]	Description	-133		Unit
		Min	Max	
t _{POWER}	V _{DD} (typical) to the first access ^[21]	1	–	ms
Clock				
t _{CYC}	Clock cycle time	7.5	–	ns
t _{CH}	Clock HIGH	2.5	–	ns
t _{CL}	Clock LOW	2.5	–	ns
Output Times				
t _{CDV}	Data output valid after CLK rise	–	6.5	ns
t _{DOH}	Data output hold after CLK rise	2.5	–	ns
t _{CLZ}	Clock to low Z ^[22, 23, 24]	2.5	–	ns
t _{CHZ}	Clock to high Z ^[22, 23, 24]	–	3.8	ns
t _{OE\bar{V}}	\overline{OE} LOW to output valid	–	3.0	ns
t _{OE\bar{L}Z}	\overline{OE} LOW to output low Z ^[22, 23, 24]	0	–	ns
t _{OE\bar{H}Z}	\overline{OE} HIGH to output high Z ^[22, 23, 24]	–	3.0	ns
Setup Times				
t _{AS}	Address setup before CLK rise	1.5	–	ns
t _{ADS}	ADSP, ADSC setup before CLK rise	1.5	–	ns
t _{ADVS}	\overline{ADV} setup before CLK rise	1.5	–	ns
t _{WES}	\overline{GW} , \overline{BWE} , \overline{BW}_X setup before CLK rise	1.5	–	ns
t _{DS}	Data input setup before CLK rise	1.5	–	ns
t _{CES}	Chip enable setup	1.5	–	ns
Hold Times				
t _{AH}	Address hold after CLK rise	0.5	–	ns
t _{ADH}	ADSP, ADSC hold after CLK rise	0.5	–	ns
t _{WEH}	\overline{GW} , \overline{BWE} , \overline{BW}_X hold after CLK rise	0.5	–	ns
t _{ADVH}	\overline{ADV} hold after CLK rise	0.5	–	ns
t _{DH}	Data input hold after CLK rise	0.5	–	ns
t _{CEH}	Chip enable hold after CLK rise	0.5	–	ns

Notes

19. Timing reference level is 1.25 V when V_{DDQ} = 2.5 V.

20. Test conditions shown in (a) of Figure 4 on page 22 unless otherwise noted.

21. This part has a voltage regulator internally; t_{POWER} is the time that the power needs to be supplied above V_{DD(minimum)} initially, before a read or write operation can be initiated.

22. t_{CHZ}, t_{CLZ}, t_{OE \bar{L} Z}, and t_{OE \bar{H} Z} are specified with AC test conditions shown in part (b) of Figure 4 on page 22. Transition is measured ±200 mV from steady-state voltage.

23. At any given voltage and temperature, t_{OE \bar{H} Z} is less than t_{OE \bar{L} Z} and t_{CHZ} is less than t_{CLZ} to eliminate bus contention between SRAMs when sharing the same data bus. These specifications do not imply a bus contention condition, but reflect parameters guaranteed over worst case user conditions. Device is designed to achieve High Z prior to Low Z under the same system conditions.

24. This parameter is sampled and not 100% tested.

Timing Diagrams

Figure 5. Read Cycle Timing [25]

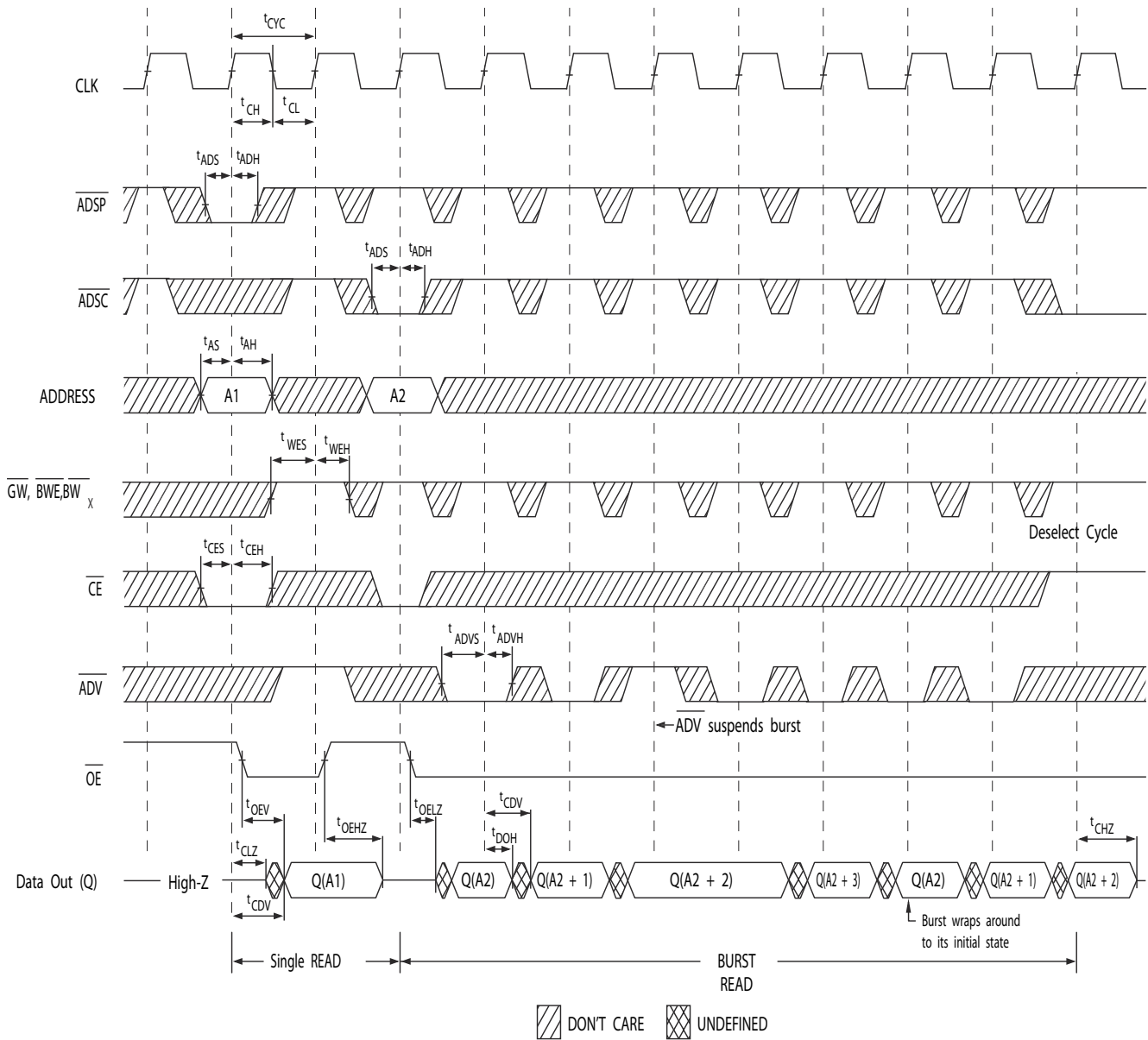

Note

25. In this diagram, when \overline{CE} is LOW: \overline{CE}_1 is LOW, CE_2 is HIGH, and \overline{CE}_3 is LOW. When \overline{CE} is HIGH: \overline{CE}_1 is HIGH or CE_2 is LOW or \overline{CE}_3 is HIGH.

Timing Diagrams (continued)

Figure 6. Write Cycle Timing [26, 27]

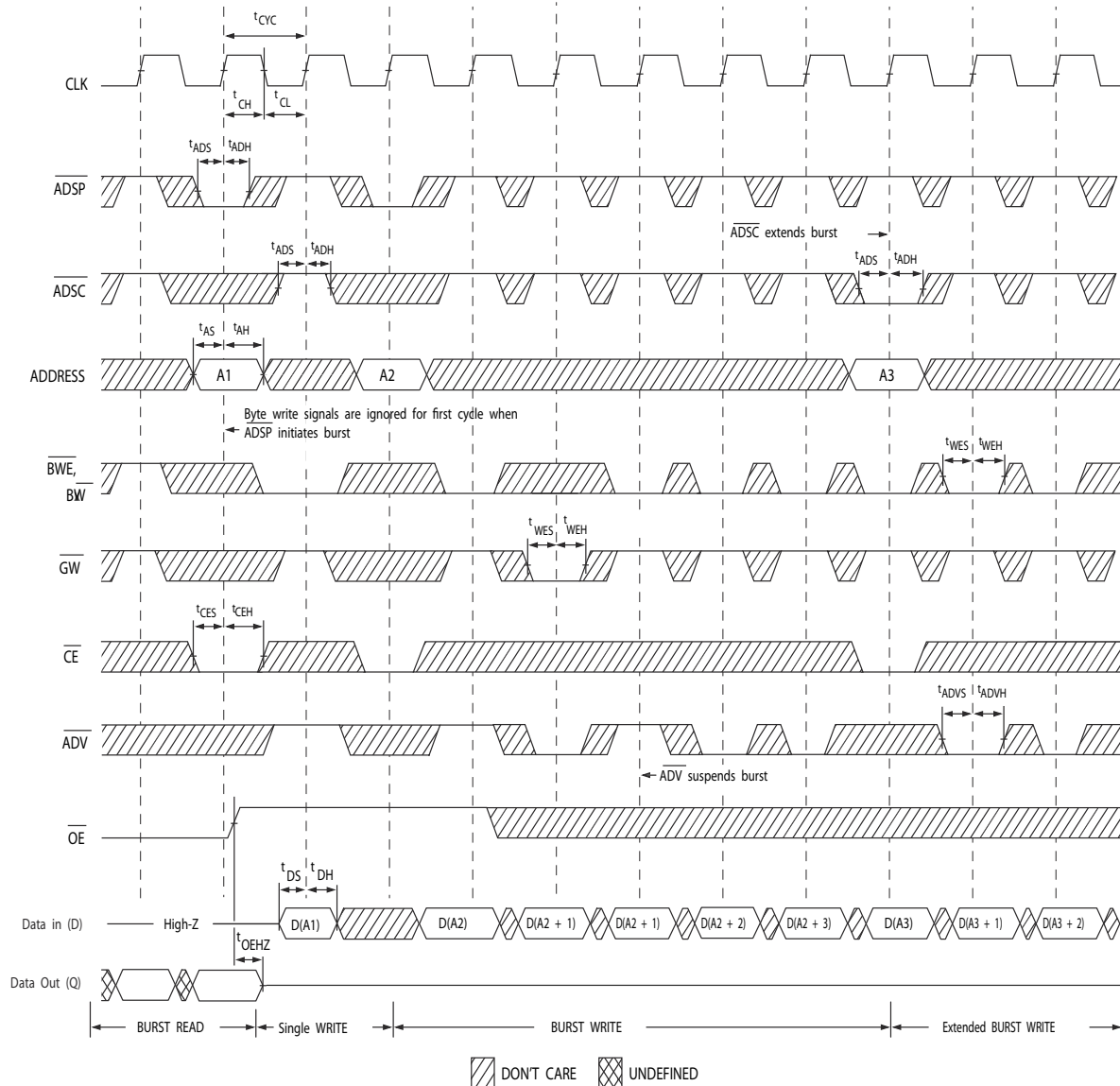

Notes

26. In this diagram, when \overline{CE} is LOW: \overline{CE}_1 is LOW, CE_2 is HIGH, and \overline{CE}_3 is LOW. When \overline{CE} is HIGH: \overline{CE}_1 is HIGH or CE_2 is LOW or \overline{CE}_3 is HIGH.
27. Full width write is initiated by either \overline{GW} LOW; or by \overline{GW} HIGH, \overline{BWE} LOW, and \overline{BW}_X LOW.

Timing Diagrams (continued)

Figure 7. Read/Write Cycle Timing [28, 29, 30]

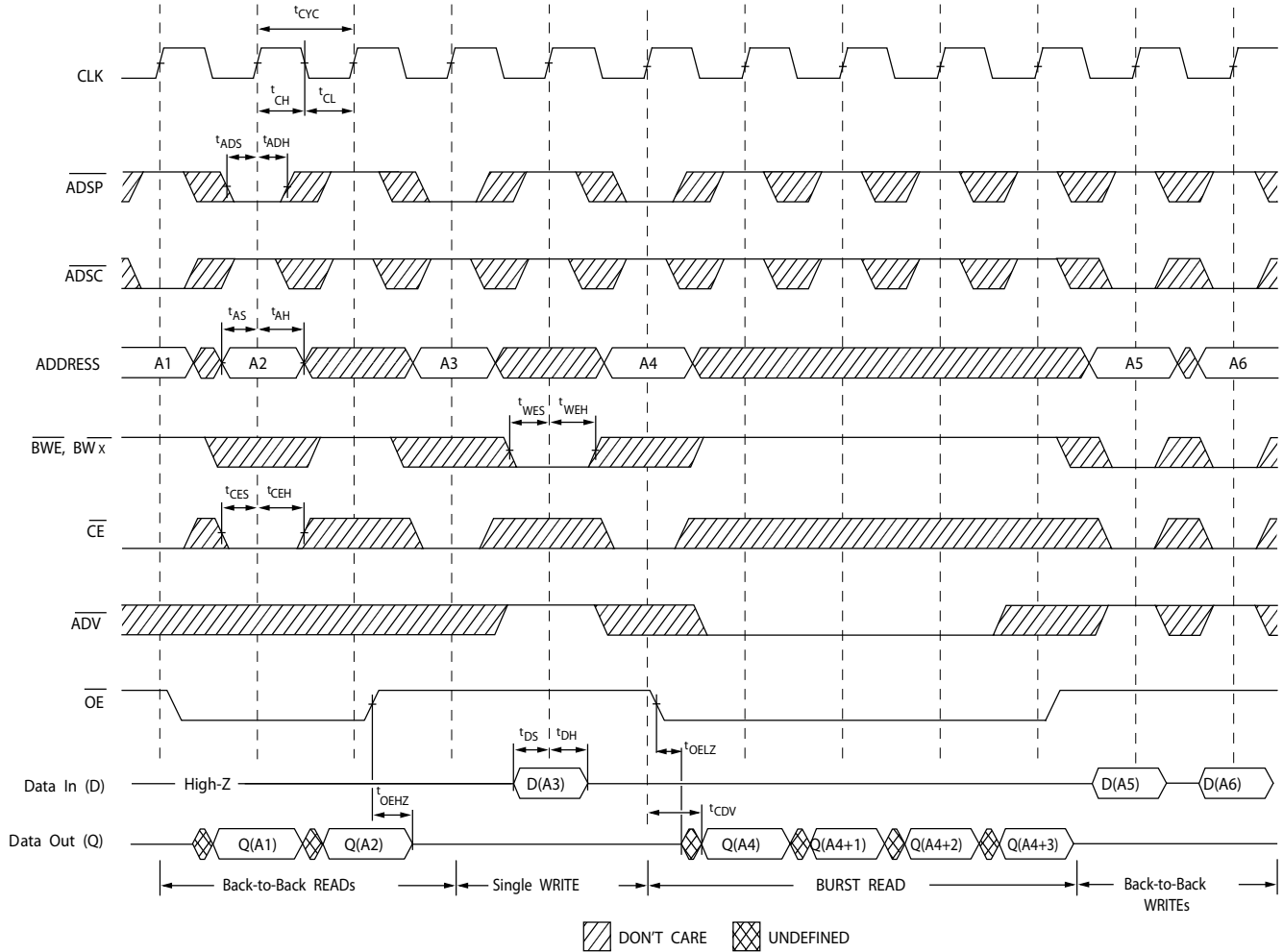

Notes

- 28. In this diagram, when \overline{CE} is LOW: \overline{CE}_1 is LOW, \overline{CE}_2 is HIGH, and \overline{CE}_3 is LOW. When \overline{CE} is HIGH: \overline{CE}_1 is HIGH or \overline{CE}_2 is LOW or \overline{CE}_3 is HIGH.
- 29. The data bus (Q) remains in high Z following a WRITE cycle, unless a new read access is initiated by \overline{ADSP} or \overline{ADSC} .
- 30. \overline{GW} is HIGH.

Timing Diagrams (continued)

Figure 8. ZZ Mode Timing [31, 32]

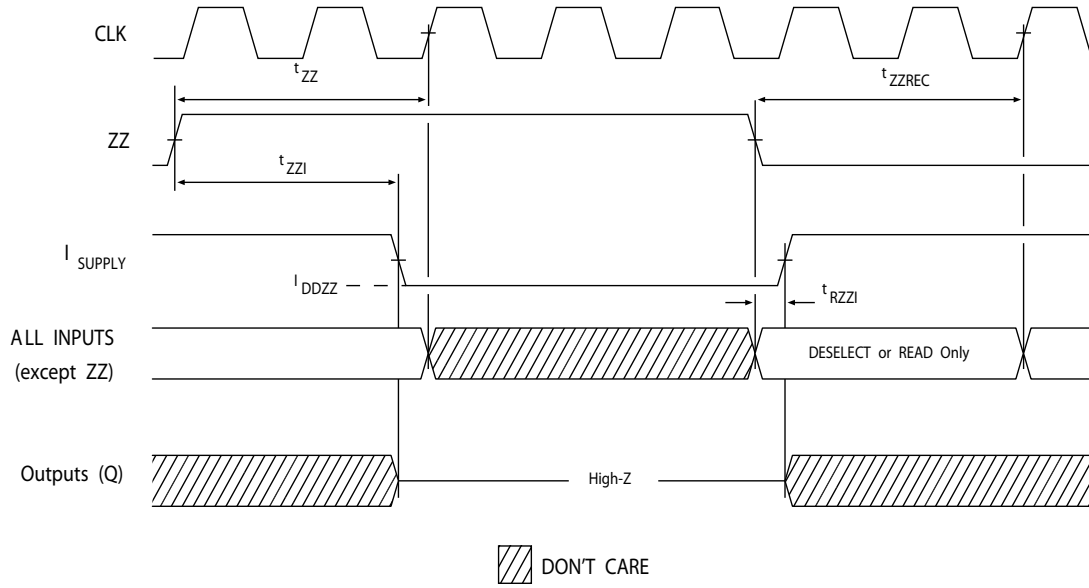

Notes

- 31. Device must be deselected when entering ZZ mode. See [Truth Table on page 10](#) for all possible signal conditions to deselect the device.
- 32. DQs are in high Z when exiting ZZ sleep mode.

Ordering Information

Not all of the speed, package, and temperature ranges are available. Contact your local sales representative or visit www.cypress.com for actual products offered.

Speed (MHz)	Ordering Code	MPN Status	Package Diagram	Part and Package Type	Operating Range
133	CY7C1441AV25-133BZXI ^[33]	NRND	51-85195	165-ball FBGA (15 × 17 × 1.4 mm) Pb-free	Industrial

Ordering Code Definitions

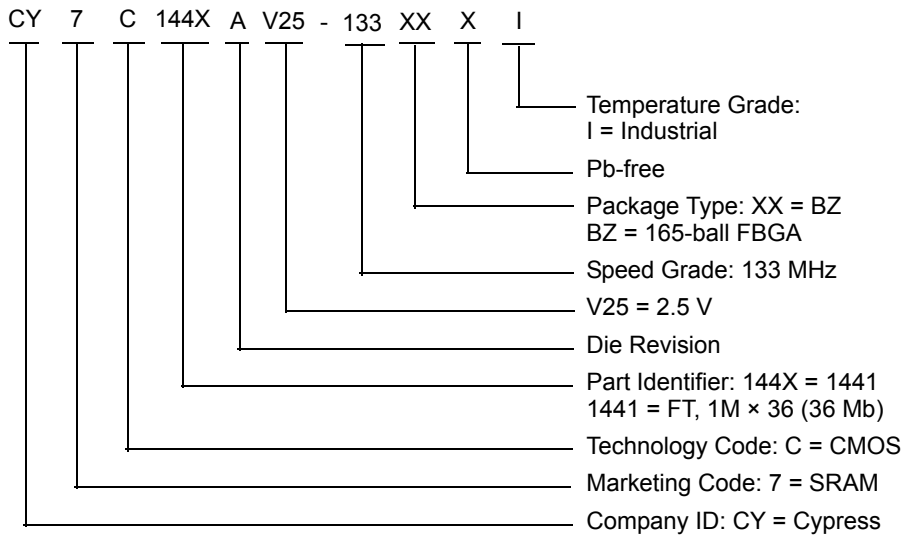

Note

33. This MPN is not recommended for new designs.

Package Diagrams

Figure 9. 165-ball FBGA (15 × 17 × 1.40 mm) (0.50 Ball Diameter) Package Outline, 51-85195

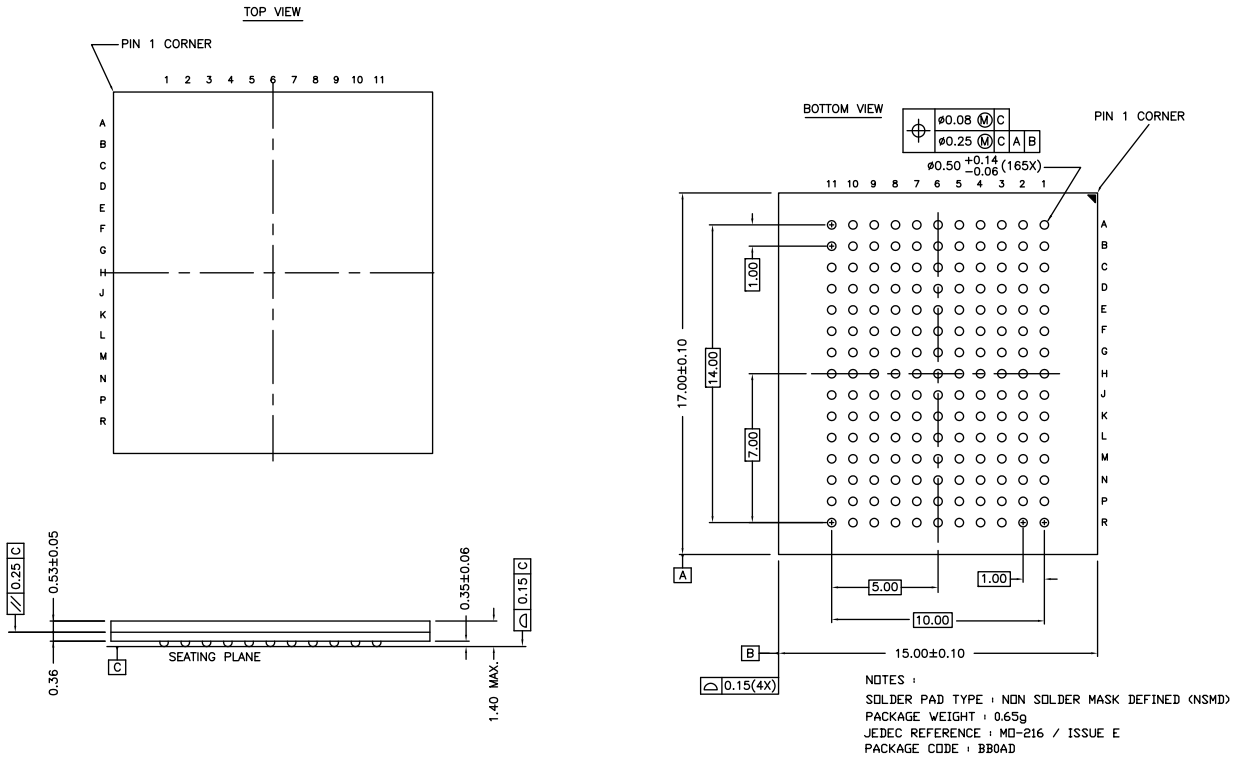

51-85195 *D

Package Diagrams (continued)

Figure 10. 209-ball FBGA (14 × 22 × 1.76 mm) BB209A Package Outline, 51-85167

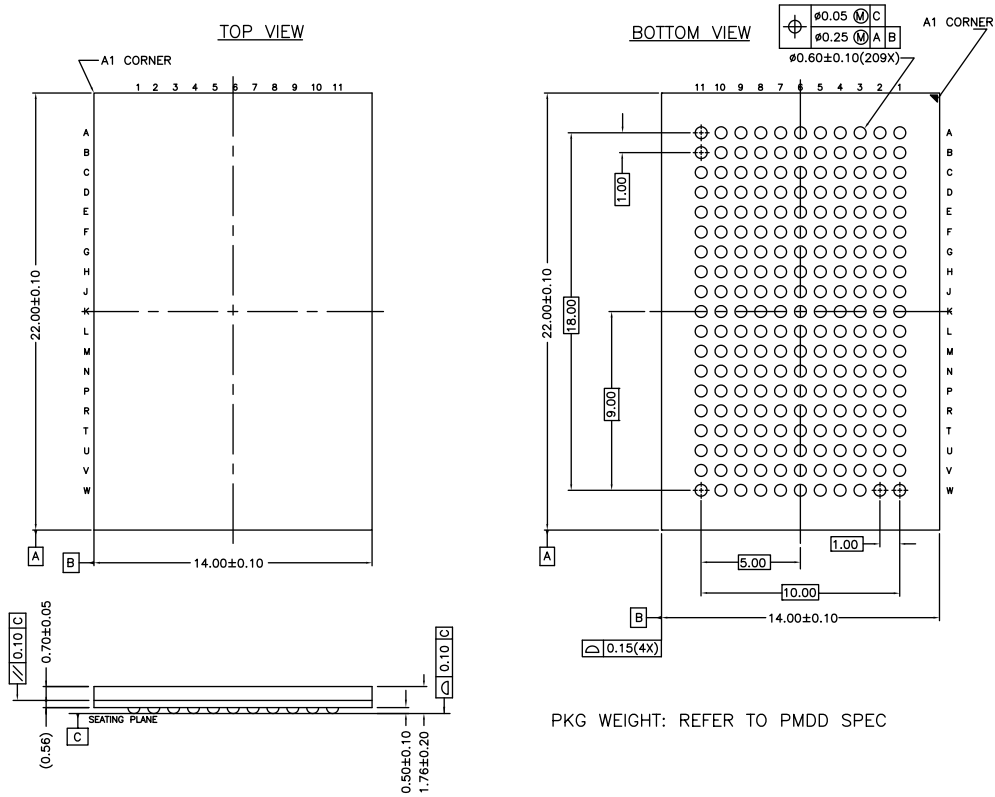

PKG WEIGHT: REFER TO PMDD SPEC

51-85167 *C

Acronyms

Acronym	Description
CE	Chip Enable
CMOS	Complementary Metal Oxide Semiconductor
EIA	Electronic Industries Alliance
FBGA	Fine-Pitch Ball Grid Array
I/O	Input/Output
JEDEC	Joint Electron Devices Engineering Council
JTAG	Joint Test Action Group
\overline{OE}	Output Enable
SRAM	Static Random Access Memory
TAP	Test Access Port
TCK	Test Clock
TDI	Test Data-In
TDO	Test Data-Out
TMS	Test Mode Select
TTL	Transistor-Transistor Logic

Document Conventions

Units of Measure

Symbol	Unit of Measure
°C	degree Celsius
MHz	megahertz
μA	microampere
mA	milliampere
mm	millimeter
ms	millisecond
mV	millivolt
ns	nanosecond
Ω	ohm
%	percent
pF	picofarad
V	volt
W	watt

Document History Page

Document Title: CY7C1441AV25/CY7C1447AV25, 36-Mbit (1M × 36/512K × 72) Flow-Through SRAM				
Document Number: 001-75380				
Rev.	ECN No.	Issue Date	Orig. of Change	Description of Change
**	3534404	02/28/2012	GOPA	New data sheet.
*A	3606230	05/02/2012	PRIT / GOPA	Updated Features (Included CY7C1441AV25 related information). Updated Functional Description (Included CY7C1441AV25 related information). Included Logic Block Diagram – CY7C1441AV25. Updated Pin Configurations (Included CY7C1441AV25 related information, included 165-ball FBGA package related information). Updated Functional Overview (Included CY7C1441AV25 related information). Updated Truth Table (Included CY7C1441AV25 related information). Added Partial Truth Table for Read/Write (Corresponding to CY7C1441AV25). Updated IEEE 1149.1 Serial Boundary Scan (JTAG) (Included CY7C1441AV25 related information). Updated Identification Register Definitions (Included CY7C1441AV25 related information). Updated Scan Register Sizes (Included 165-ball FBGA package related information, added Bit Size (× 36) column). Added Boundary Scan Order (Corresponding to CY7C1441AV25). Updated Capacitance (Included 165-ball FBGA package related information). Updated Thermal Resistance (Included 165-ball FBGA package related information). Updated Ordering Information (Updated part numbers). Updated Package Diagrams (Included 165-ball FBGA package related information (spec 51-85165)).
*B	3925180	03/07/2013	PRIT	Updated Package Diagrams : spec 51-85167 – Changed revision from *B to *C.
*C	4575392	11/20/2014	PRIT	Updated Functional Description : Added “For a complete list of related documentation, click here .” at the end.
*D	4675874	03/04/2015	PRIT	Updated Ordering Information : Updated part numbers. Updated Package Diagrams : Removed spec 51-85165 *D. Added spec 51-85195 *C. Updated to new template.
*E	4908404	09/04/2015	PRIT	Removed 1.8 V TAP AC Test Conditions. Removed 1.8 V TAP AC Output Load Equivalent. Updated TAP DC Electrical Characteristics and Operating Conditions : Removed details corresponding to Test Condition “VDDQ = 1.8 V” for all parameters. Updated Electrical Characteristics : Removed details corresponding to Test Condition “for 1.8 V I/O” for all parameters. Updated Package Diagrams : spec 51-85195 – Changed revision from *C to *D.
*F	5164560	03/07/2016	PRIT	Added watermark “Not Recommended for New Designs.” across the document. Updated Ordering Information : No change in part numbers. Added a column “MPN Status”. Added Note 33 and referred the same note in “CY7C1441AV25-133BZXI”. Updated to new template. Completing Sunset Review.

Sales, Solutions, and Legal Information

Worldwide Sales and Design Support

Cypress maintains a worldwide network of offices, solution centers, manufacturer's representatives, and distributors. To find the office closest to you, visit us at [Cypress Locations](#).

Products

ARM® Cortex® Microcontrollers	cypress.com/arm
Automotive	cypress.com/automotive
Clocks & Buffers	cypress.com/clocks
Interface	cypress.com/interface
Lighting & Power Control	cypress.com/powerpsoc
Memory	cypress.com/memory
PSoC	cypress.com/psoc
Touch Sensing	cypress.com/touch
USB Controllers	cypress.com/usb
Wireless/RF	cypress.com/wireless

PSoC® Solutions

cypress.com/psoc
PSoC 1 | PSoC 3 | PSoC 4 | PSoC 5LP

Cypress Developer Community

[Community](#) | [Forums](#) | [Blogs](#) | [Video](#) | [Training](#)

Technical Support

cypress.com/support

© Cypress Semiconductor Corporation 2012-2016. This document is the property of Cypress Semiconductor Corporation and its subsidiaries, including Spansion LLC ("Cypress"). This document, including any software or firmware included or referenced in this document ("Software"), is owned by Cypress under the intellectual property laws and treaties of the United States and other countries worldwide. Cypress reserves all rights under such laws and treaties and does not, except as specifically stated in this paragraph, grant any license under its patents, copyrights, trademarks, or other intellectual property rights. If the Software is not accompanied by a license agreement and you do not otherwise have a written agreement with Cypress governing the use of the Software, then Cypress hereby grants you under its copyright rights in the Software, a personal, non-exclusive, nontransferable license (without the right to sublicense) (a) for Software provided in source code form, to modify and reproduce the Software solely for use with Cypress hardware products, only internally within your organization, and (b) to distribute the Software in binary code form externally to end users (either directly or indirectly through resellers and distributors), solely for use on Cypress hardware product units. Cypress also grants you a personal, non-exclusive, nontransferable, license (without the right to sublicense) under those claims of Cypress's patents that are infringed by the Software (as provided by Cypress, unmodified) to make, use, distribute, and import the Software solely to the minimum extent that is necessary for you to exercise your rights under the copyright license granted in the previous sentence. Any other use, reproduction, modification, translation, or compilation of the Software is prohibited.

CYPRESS MAKES NO WARRANTY OF ANY KIND, EXPRESS OR IMPLIED, WITH REGARD TO THIS DOCUMENT OR ANY SOFTWARE, INCLUDING, BUT NOT LIMITED TO, THE IMPLIED WARRANTIES OF MERCHANTABILITY AND FITNESS FOR A PARTICULAR PURPOSE. Cypress reserves the right to make changes to this document without further notice. Cypress does not assume any liability arising out of the application or use of any product or circuit described in this document. Any information provided in this document, including any sample design information or programming code, is provided only for reference purposes. It is the responsibility of the user of this document to properly design, program, and test the functionality and safety of any application made of this information and any resulting product. Cypress products are not designed, intended, or authorized for use as critical components in systems designed or intended for the operation of weapons, weapons systems, nuclear installations, life-support devices or systems, other medical devices or systems (including resuscitation equipment and surgical implants), pollution control or hazardous substances management, or other uses where the failure of the device or system could cause personal injury, death, or property damage ("Unintended Uses"). A critical component is any component of a device or system whose failure to perform can be reasonably expected to cause the failure of the device or system, or to affect its safety or effectiveness. Cypress is not liable, in whole or in part, and Company shall and hereby does release Cypress from any claim, damage, or other liability arising from or related to all Unintended Uses of Cypress products. Company shall indemnify and hold Cypress harmless from and against all claims, costs, damages, and other liabilities, including claims for personal injury or death, arising from or related to any Unintended Uses of Cypress products.

Cypress, the Cypress logo, Spansion, the Spansion logo, and combinations thereof, PSoC, CapSense, EZ-USB, F-RAM, and Traveo are trademarks or registered trademarks of Cypress in the United States and other countries. For a more complete list of Cypress trademarks, visit cypress.com. Other names and brands may be claimed as property of their respective owners.