



Please note that Cypress is an Infineon Technologies Company.

The document following this cover page is marked as “Cypress” document as this is the company that originally developed the product. Please note that Infineon will continue to offer the product to new and existing customers as part of the Infineon product portfolio.

Continuity of document content

The fact that Infineon offers the following product as part of the Infineon product portfolio does not lead to any changes to this document. Future revisions will occur when appropriate, and any changes will be set out on the document history page.

Continuity of ordering part numbers

Infineon continues to support existing part numbers. Please continue to use the ordering part numbers listed in the datasheet for ordering.

2-Mbit (128K words × 16-bit) Static RAM with Error-Correcting Code (ECC)

Features

- AEC-Q100 qualified
- High speed
 - t_{AA} = 10 ns; 12 ns
- Temperature range
 - Automotive-A: -40 °C to 85 °C
 - Automotive-E: -40 °C to 125 °C
- Embedded error-correcting code (ECC) for single-bit error correction^[1, 2]
- Low active and standby current
 - Active current, I_{CC} = 40-mA typical (Automotive-E)
 - Standby current, I_{SB2} = 6-mA typical (Automotive-E)
- Operating voltage range: 2.2 V to 3.6 V
- 1.0-V data retention
- TTL compatible inputs and outputs
- Available in Pb-free 48-ball VFBGA and 44-pin TSOP II packages

Functional Description

CY7C1011G is a high-performance CMOS fast static RAM automotive part with embedded ECC. This device has a single Chip Enable (\overline{CE}) input, and is accessed by asserting it LOW.

To perform data writes, assert the Write Enable (\overline{WE}) input LOW, and provide the data on the device data pins (I/O_0 through I/O_{15}) and address pins (A_0 through A_{16}) pins. The Byte High Enable (\overline{BHE}) and Byte Low Enable (\overline{BLE}) inputs control byte writes and write data on the corresponding I/O lines to the memory location specified. \overline{BHE} controls I/O_8 through I/O_{15} and \overline{BLE} controls I/O_0 through I/O_7 .

To perform data reads, assert the Output Enable (\overline{OE}) input and provide the required address on the address lines. You can access read data on the I/O lines (I/O_0 through I/O_{15}). To perform byte access, assert the required byte enable signal (\overline{BHE} or \overline{BLE}) to read either the upper byte or the lower byte of data from the specified address location.

All I/O s (I/O_0 through I/O_{15}) are placed in a high-impedance state when the device is deselected (\overline{CE} LOW), or when the control signals are deasserted (\overline{OE} , \overline{BLE} , \overline{BHE}).

Logic Block Diagram – CY7C1011G

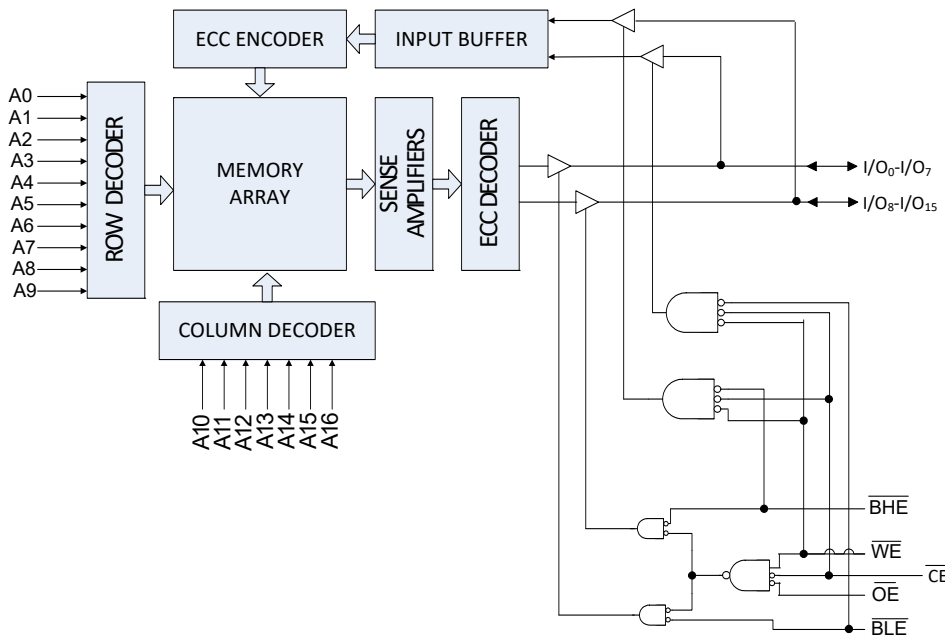

Notes

1. This device does not support automatic write-back on error detection.
2. SER Rate < 0.1 FIT/Mb. Refer to AN88889 for details.

Contents

Pin Configurations	3	Ordering Information	12
Product Portfolio	3	Ordering Code Definitions	12
Maximum Ratings	4	Package Diagrams	13
Operating Range	4	Acronyms	15
DC Electrical Characteristics	4	Document Conventions	15
Capacitance	5	Units of Measure	15
Thermal Resistance	5	Document History Page	16
AC Test Loads and Waveforms	5	Sales, Solutions, and Legal Information	17
Data Retention Characteristics	6	Worldwide Sales and Design Support	17
Data Retention Waveform	6	Products	17
AC Switching Characteristics	7	PSoC® Solutions	17
Switching Waveforms	8	Cypress Developer Community	17
Truth Table	11	Technical Support	17

Pin Configurations

Figure 1. 48-ball VFBGA pinout^[3]

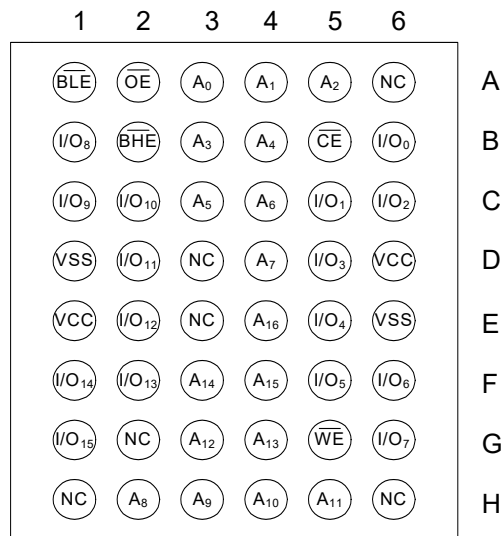
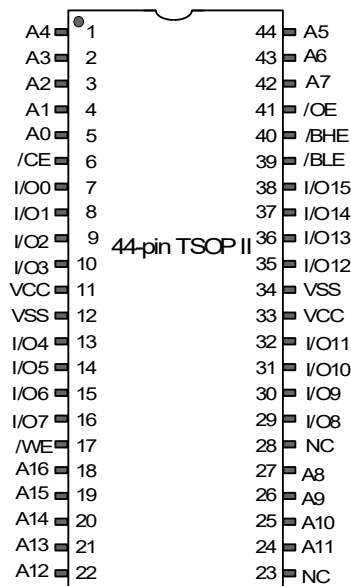

Figure 2. 44-pin TSOP II pinout^[3]



Product Portfolio

Product	Range	V _{CC} Range (V)	Speed (ns)	Power Dissipation			
				Operating I _{CC} , (mA)		Standby, I _{SB2} (mA)	
				f = f _{max}			
				Typ ^[4]	Max	Typ ^[4]	Max
CY7C1011G30	Automotive-E	2.2 V–3.6 V	10, 12	40	50	6	14
	Automotive-A		10	38	45	6	8

Notes

- 3. NC pins are not connected internally to the die.
- 4. Typical values are included for reference only and are not guaranteed or tested.

Maximum Ratings

Exceeding maximum ratings may impair the useful life of the device. These user guidelines are not tested.

Storage temperature -65 °C to +150 °C
 Ambient temperature
 with power applied -55 °C to +125 °C
 Supply voltage
 on V_{CC} relative to GND^[5] -0.5 V to $V_{CC} + 0.3$ V
 DC voltage applied to outputs
 in HI-Z State^[5] -0.3 V to $V_{CC} + 0.3$ V

DC input voltage^[5] -0.3 V to $V_{CC} + 0.3$ V
 Current into outputs (in low state) 20 mA
 Static discharge voltage
 (MIL-STD-883, Method 3015) > 2001 V
 Latch-up current > 140 mA

Operating Range

Grade	Ambient Temperature	V_{CC}
Automotive-E	-40 °C to +125 °C	2.2 V to 3.6 V
Automotive-A	-40 °C to +85 °C	2.2 V to 3.6 V

DC Electrical Characteristics

Over the Operating Range

Parameter	Description	Test Conditions	10 ns (Automotive-A)			10 ns/ 12ns (Automotive-E)			Unit		
			Min	Typ	Max	Min	Typ	Max			
V_{OH}	Output HIGH voltage	2.2 V to 2.7 V	$V_{CC} = \text{Min}, I_{OH} = -1.0 \text{ mA}$		2	-	-	2	-	-	V
		2.7 V to 3.0 V	$V_{CC} = \text{Min}, I_{OH} = -4.0 \text{ mA}$		2.2	-	-	2.2	-	-	
		3.0 V to 3.6 V	$V_{CC} = \text{Min}, I_{OH} = -4.0 \text{ mA}$		2.4	-	-	2.4	-	-	
V_{OL}	Output LOW voltage	2.2 V to 2.7 V	$V_{CC} = \text{Min}, I_{OL} = 2 \text{ mA}$		-	-	0.4	-	-	0.4	V
		2.7 V to 3.6 V	$V_{CC} = \text{Min}, I_{OL} = 8 \text{ mA}$		-	-	0.4	-	-	0.4	
V_{IH}	Input HIGH voltage	2.2 V to 2.7 V	-		2	-	$V_{CC} + 0.3^{[5]}$	2	-	$V_{CC} + 0.3^{[5]}$	V
		2.7 V to 3.6 V	-		2	-	$V_{CC} + 0.3^{[5]}$	2	-	$V_{CC} + 0.3^{[5]}$	
V_{IL}	Input LOW voltage	2.2 V to 2.7 V	-		-0.3 ^[5]	-	0.6	-0.3 ^[5]	-	0.6	V
		2.7 V to 3.6 V	-		-0.3 ^[5]	-	0.8	-0.3 ^[5]	-	0.8	
I_{IX}	Input leakage current	$GND \leq V_{IN} \leq V_{CC}$	-1	-	+1	-5	-	+5	μA		
I_{OZ}	Output leakage current	$GND \leq V_{OUT} \leq V_{CC}$, Output disabled	-1	-	+1	-5	-	+5	μA		
I_{CC}	Operating supply current	$V_{CC} = 3.6 \text{ V}$, $I_{OUT} = 0 \text{ mA}$, CMOS levels	-	38	45	-	40	50	mA		
I_{SB1}	Automatic CE power down current – TTL inputs	$V_{CC} = 3.6 \text{ V}$, $\overline{CE} \geq V_{IH}$, $V_{IN} \geq V_{IH}$ or $V_{IN} \leq V_{IL}$, $f = f_{MAX}$	-	-	15	-	-	24	mA		
I_{SB2}	Automatic CE power down current – CMOS inputs	$V_{CC} = 3.6 \text{ V}$, $\overline{CE} \geq V_{CC} - 0.2 \text{ V}$, $V_{IN} \geq V_{CC} - 0.2 \text{ V}$ or $V_{IN} \leq 0.2 \text{ V}, f = 0$	-	6	8	-	6	14	mA		

Note

5. $V_{IL(\text{min})} = -2.0 \text{ V}$ and $V_{IH(\text{max})} = V_{CC} + 2 \text{ V}$ for pulse durations of less than 20 ns.

Capacitance

Parameter [6]	Description	Test Conditions	All Packages	Unit
C _{IN}	Input capacitance	T _A = 25 °C, f = 1 MHz, V _{CC} = V _{CC(typ)}	10	pF
C _{OUT}	I/O capacitance		10	pF

Thermal Resistance

Parameter [6]	Description	Test Conditions	48-ball VFBGA	44-pin TSOPII	Unit
θ _{JA}	Thermal resistance (junction to ambient)	Still air, soldered on a 3 × 4.5 inch, four-layer printed circuit board	30.68	66.82	°C/W
θ _{JC}	Thermal resistance (junction to case)		14.83	15.97	°C/W

AC Test Loads and Waveforms

Figure 3. AC Test Loads and Waveforms [7]

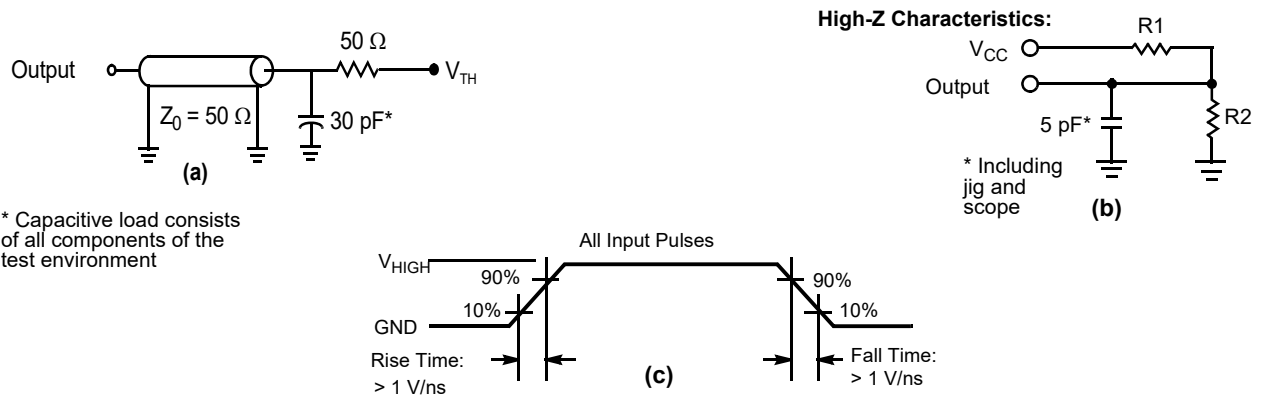

* Capacitive load consists of all components of the test environment

Parameters	3.0 V	Unit
R1	317	Ω
R2	351	Ω
V _{TH}	1.5	V
V _{HIGH}	3	V

Notes

- Tested initially and after any design or process change that may affect these parameters.
- Full-device AC operation assumes a 100-μs ramp time from 0 to V_{CC(min)} and a 100-μs wait time after V_{CC} stabilization.

Data Retention Characteristics

Over the Operating Range

Parameter	Description	Conditions	Automotive-A		Automotive-E		Unit
			Min	Max	Min	Max	
V_{DR}	V_{CC} for data retention	–	1	–	1	–	V
I_{CCDR}	Data retention current	$V_{CC} = 1.2\text{ V}$, $\overline{CE} \geq V_{CC} - 0.2\text{ V}$, $V_{IN} \geq V_{CC} - 0.2\text{ V}$ or $V_{IN} \leq 0.2\text{ V}$	–	8	–	14	mA
$t_{CDR}^{[8]}$	Chip deselect to data retention time	–	0	–	0	–	ns
$t_R^{[8,9]}$	Operation recovery time	$V_{CC} \geq 2.2\text{ V}$, $t_{AA} = 10\text{ ns}$	10	–	10	–	ns
		$V_{CC} \geq 2.2\text{ V}$, $t_{AA} = 12\text{ ns}$	–	–	12	–	ns

Data Retention Waveform

Figure 4. Data Retention Waveform ^[9]

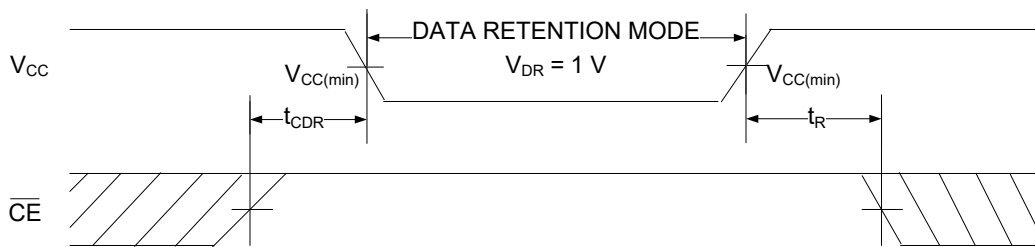

Notes

- 8. These parameters are guaranteed by design.
- 9. Full-device operation requires linear V_{CC} ramp from V_{DR} to $V_{CC(min.)} \geq 100\ \mu\text{s}$ or stable at $V_{CC(min.)} \geq 100\ \mu\text{s}$.

AC Switching Characteristics

Over the Operating Range

Parameter ^[10]	Description	10 ns (Automotive-A/ Automotive-E)		12 ns (Automotive-E)		Unit
		Min	Max	Min	Max	
Read Cycle						
t_{RC}	Read cycle time	10	–	12	–	ns
t_{AA}	Address to data	–	10	–	12	ns
t_{OHA}	Data	3	–	3	–	ns
t_{ACE}	\overline{CE} LOW to data ^[11]	–	10	–	12	ns
t_{DOE}	\overline{OE} LOW to data	–	4.5	–	7	ns
t_{LZOE}	\overline{OE} LOW to low impedance ^[11, 12]	0	–	0	–	ns
t_{HZOE}	\overline{OE} HIGH to HI-Z ^[11, 12]	–	5	–	6	ns
t_{LZCE}	\overline{CE} LOW to low impedance ^[11, 11, 12]	3	–	3	–	ns
t_{HZCE}	\overline{CE} HIGH to HI-Z ^[11, 11, 12]	–	5	–	6	ns
t_{PU}	\overline{CE} LOW to power up ^[11, 12]	0	–	0	–	ns
t_{PD}	\overline{CE} HIGH to power down ^[11, 12]	–	10	–	12	ns
t_{DBE}	Byte enable to data valid	–	4.5	–	7	ns
t_{LZBE}	Byte enable to low impedance ^[12]	0	–	0	–	ns
t_{HZBE}	Byte disable to HI-Z ^[12]	–	6	–	6	ns
Write Cycle ^[13, 14]						
t_{WC}	Write cycle time	10	–	12	–	ns
t_{SCE}	\overline{CE} LOW to write end ^[11]	7	–	8	–	ns
t_{AW}	Address setup to write end	7	–	8	–	ns
t_{HA}	Address hold from write end	0	–	0	–	ns
t_{SA}	Address setup to write start	0	–	0	–	ns
t_{PWE}	\overline{WE} pulse width	7	–	8	–	ns
t_{SD}	Data setup to write end	5	–	6	–	ns
t_{HD}	Data hold from write end	0	–	0	–	ns
t_{LZWE}	\overline{WE} HIGH to low impedance ^[11, 12]	3	–	3	–	ns
t_{HZWE}	\overline{WE} LOW to HI-Z ^[11, 12]	–	5	–	6	ns
t_{BW}	Byte Enable to write end	7	–	8	–	ns

Notes

- Test conditions assume a signal transition time (rise/fall) of 3 ns or less, timing reference levels of 1.5 V (for $V_{CC} \geq 3$ V) and $V_{CC}/2$ (for $V_{CC} < 3$ V), and input pulse levels of 0 to 3 V (for $V_{CC} \geq 3$ V) and 0 to V_{CC} (for $V_{CC} < 3$ V). Test conditions for the read cycle use output loading shown in part (a) of Figure 3 on page 5, unless specified otherwise.
- t_{HZOE} , t_{HZCE} , t_{HZWE} , t_{HZBE} , t_{LZOE} , t_{LZCE} , t_{LZWE} , and t_{LZBE} are specified with a load capacitance of 5 pF as in (b) of Figure 3 on page 5. Transition is measured ± 200 mV from steady state voltage.
- These parameters are guaranteed by design and are not tested.
- The internal write time of the memory is defined by the overlap of $\overline{WE} = V_{IL}$, $\overline{CE} = V_{IL}$ and \overline{BHE} or $\overline{BLE} = V_{IL}$. These signals must be LOW to initiate a write, and the HIGH transition of any of these signals can terminate the operation. The input data setup and hold timing should be referenced to the edge of the signal that terminates the write.
- The minimum write cycle pulse width for Write Cycle No. 2 (\overline{WE} Controlled, \overline{OE} LOW) should be equal to sum of t_{SD} and t_{HZWE} .

Switching Waveforms

Figure 5. Read Cycle No. 1 of CY7C1011G (Address Transition Controlled) [15, 16]

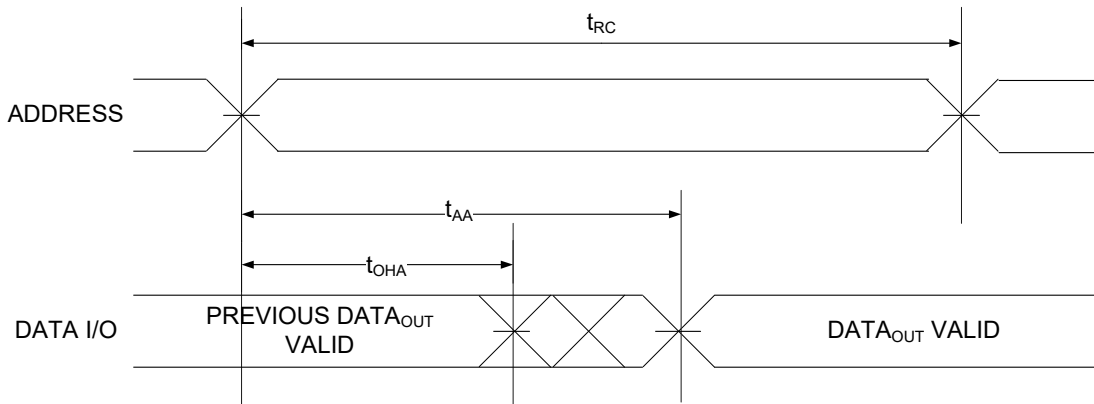
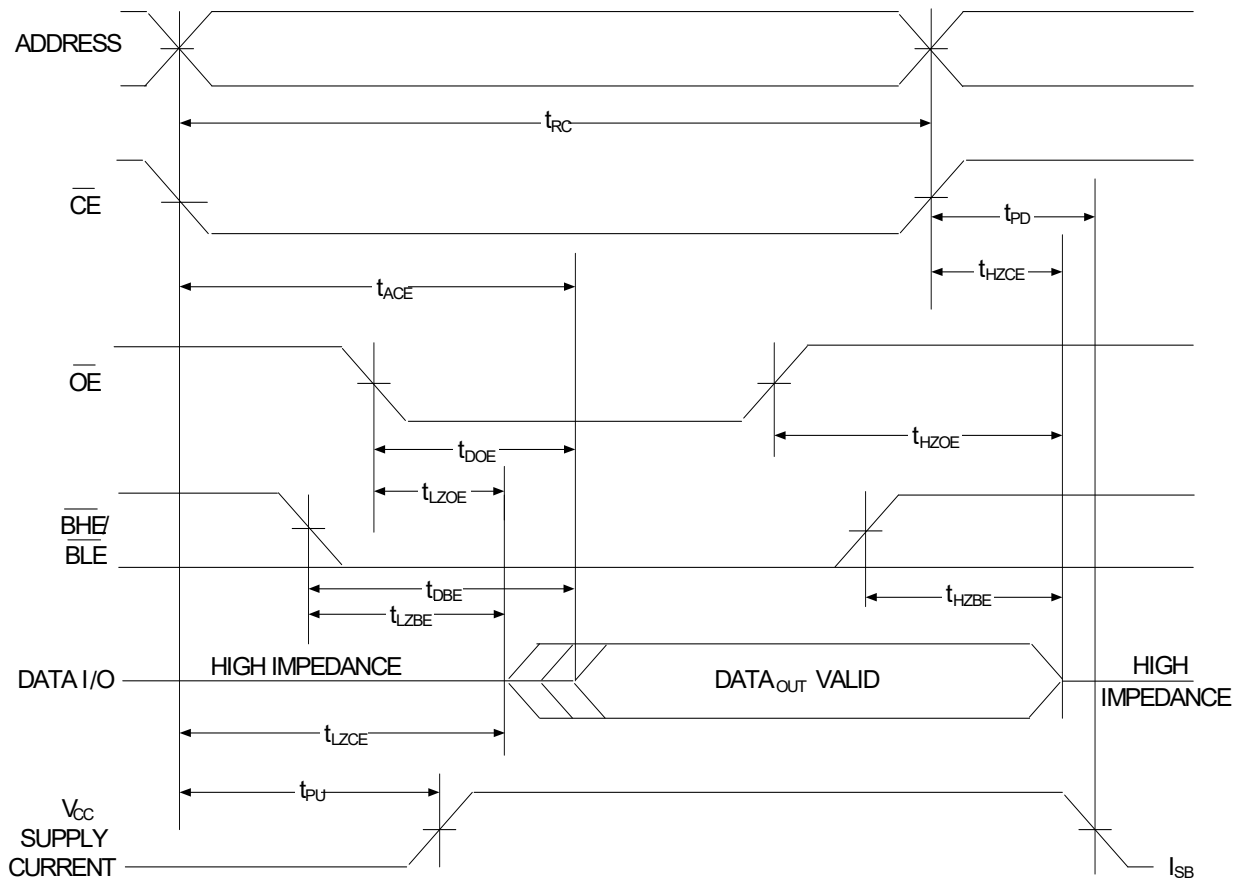

Figure 6. Read Cycle No. 2 (\overline{OE} Controlled) [16]



Notes

- 15. The device is continuously selected, $\overline{OE} = V_{IL}$, $\overline{CE} = V_{IL}$, \overline{BHE} or \overline{BLE} or both = V_{IL} .
- 16. \overline{WE} is HIGH for read cycle.

Switching Waveforms (continued)

Figure 7. Write Cycle No. 1 ($\overline{\text{CE}}$ Controlled) [17, 18, 19]

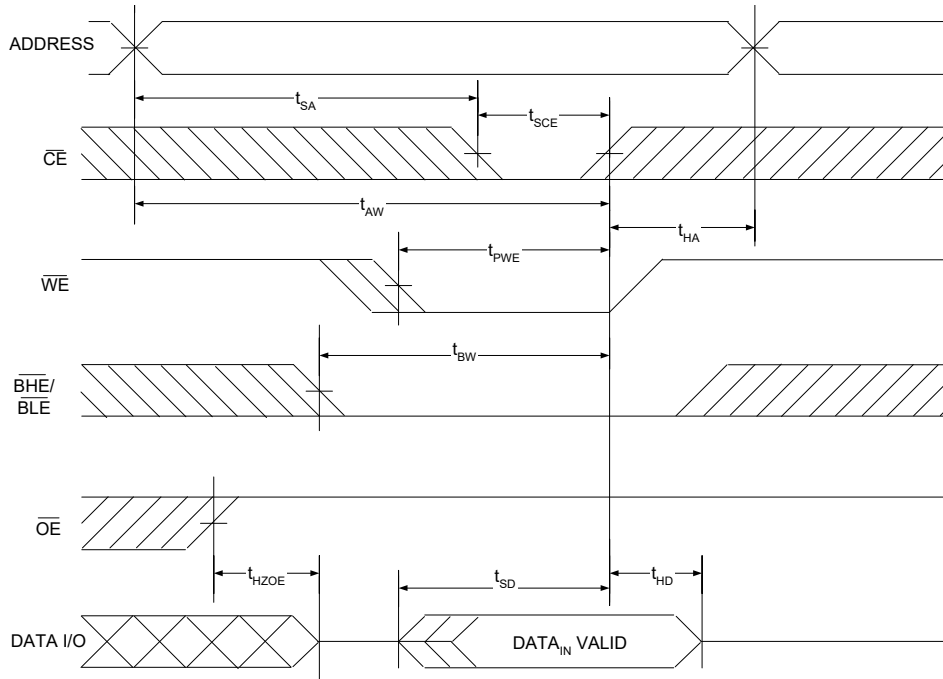
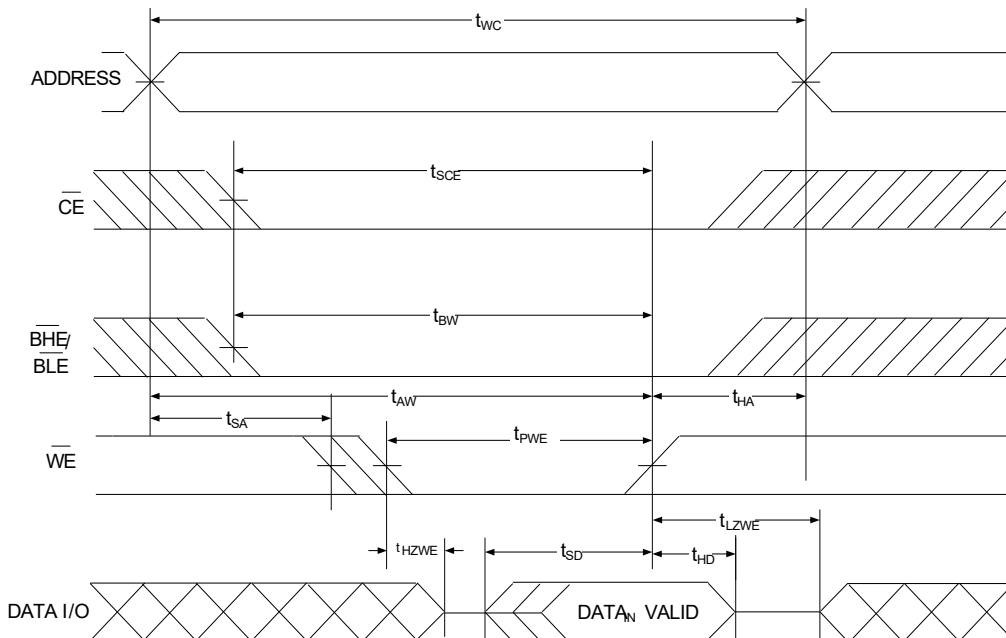

Figure 8. Write Cycle No. 2 ($\overline{\text{WE}}$ Controlled, $\overline{\text{OE}}$ LOW) [17, 18, 19, 20]



Notes

- 17. Address valid prior to or coincident with $\overline{\text{CE}}$ LOW transition.
- 18. The internal write time of the memory is defined by the overlap of $\overline{\text{WE}} = V_{\text{IL}}$, $\overline{\text{CE}} = V_{\text{IL}}$ and $\overline{\text{BHE}}$ or $\overline{\text{BLE}} = V_{\text{IL}}$. These signals must be LOW to initiate a write, and the HIGH transition of any of these signals can terminate the operation. The input data setup and hold timing should be referenced to the edge of the signal that terminates the write.
- 19. Data I/O is in HI-Z state if $\overline{\text{CE}} = V_{\text{IH}}$, or $\overline{\text{OE}} = V_{\text{IH}}$ or $\overline{\text{BHE}}$, and/or $\overline{\text{BLE}} = V_{\text{IH}}$.
- 20. The minimum write cycle pulse width should be equal to sum of t_{SD} and t_{HZWE} .

Switching Waveforms (continued)

Figure 9. Write Cycle No. 3 ($\overline{\text{BLE}}$ or $\overline{\text{BHE}}$ Controlled) [21, 22]

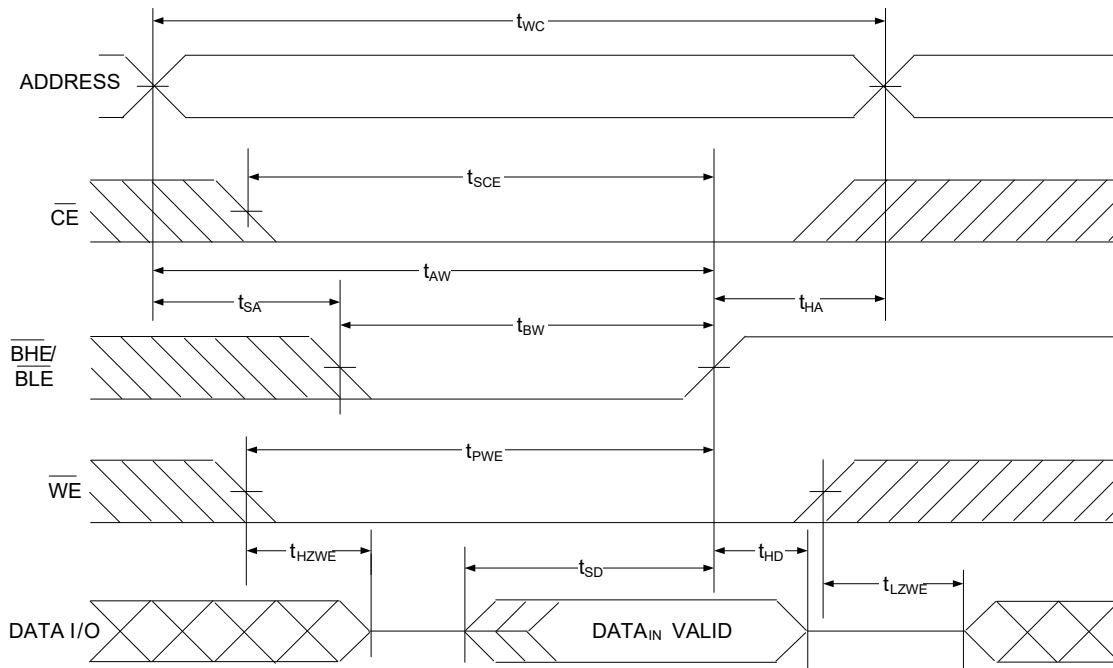
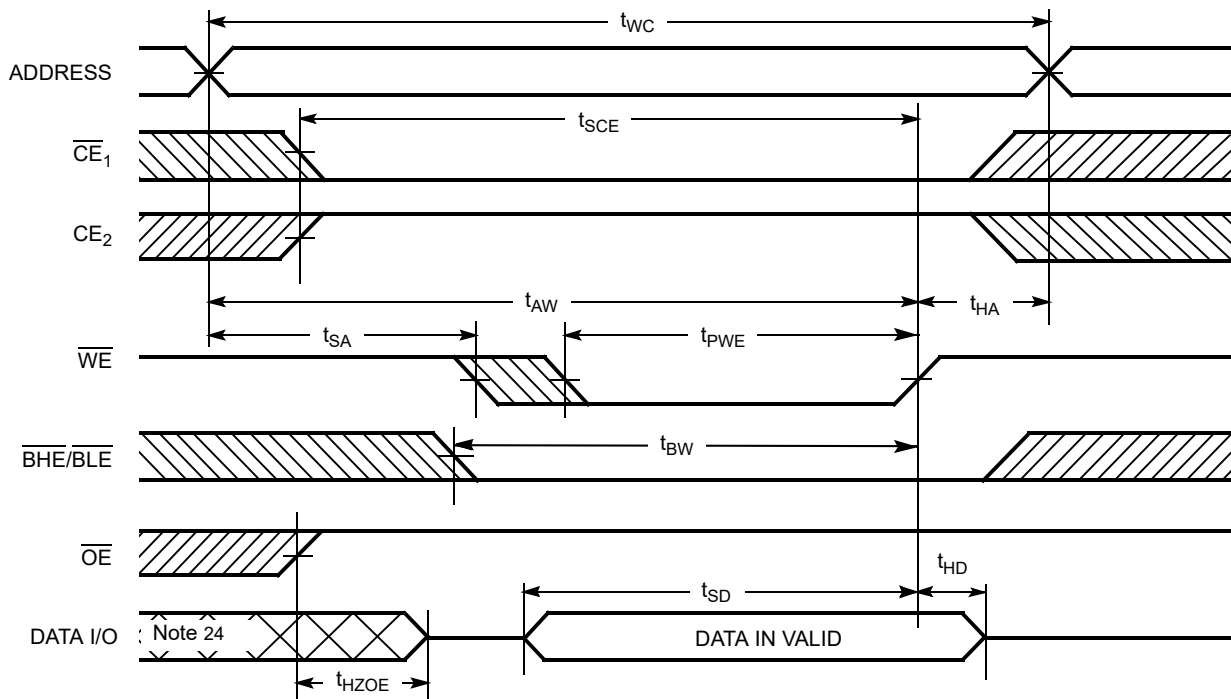

Figure 10. Write Cycle No. 4 ($\overline{\text{WE}}$ Controlled) [21, 22, 23]



Notes

- 21. The internal write time of the memory is defined by the overlap of $\overline{\text{WE}} = V_{\text{IL}}$, $\overline{\text{CE}} = V_{\text{IL}}$ and $\overline{\text{BHE}}$ or $\overline{\text{BLE}} = V_{\text{IL}}$. These signals must be LOW to initiate a write, and the HIGH transition of any of these signals can terminate the operation. The input data setup and hold timing should be referenced to the edge of the signal that terminates the write.
- 22. Data I/O is in HI-Z state if $\overline{\text{CE}} = V_{\text{IH}}$, or $\overline{\text{OE}} = V_{\text{IH}}$ or $\overline{\text{BHE}}$, and/or $\overline{\text{BLE}} = V_{\text{IH}}$.
- 23. Data I/O is high impedance if $\overline{\text{OE}} = V_{\text{IH}}$.
- 24. During this period the I/Os are in output state. Do not apply input signals.

Truth Table

$\overline{\text{CE}}$	$\overline{\text{OE}}$	$\overline{\text{WE}}$	$\overline{\text{BLE}}$	$\overline{\text{BHE}}$	I/O ₀ –I/O ₇	I/O ₈ –I/O ₁₅	Mode	Power
H	X	X	X	X	HI-Z	HI-Z	Power-down	Standby (I _{SB})
L	L	H	L	L	Data out	Data out	Read all bits	Active (I _{CC})
L	L	H	L	H	Data out	HI-Z	Read lower bits only	Active (I _{CC})
L	L	H	H	L	HI-Z	Data out	Read upper bits only	Active (I _{CC})
L	X	L	L	L	Data in	Data in	Write all bits	Active (I _{CC})
L	X	L	L	H	Data in	HI-Z	Write lower bits only	Active (I _{CC})
L	X	L	H	L	HI-Z	Data in	Write upper bits only	Active (I _{CC})
L	H	H	X	X	HI-Z	HI-Z	Selected, outputs disabled	Active (I _{CC})

Ordering Information

Speed (ns)	Ordering Code	Voltage Range	Package Diagram	Package Type (All Pb-free)	Operating Range
10	CY7C1011G30-10ZSXA	2.2 V–3.6 V	51-85087	44-pin TSOP II	Automotive-A
	CY7C1011G30-10ZSXAT	2.2 V–3.6 V	51-85087	44-pin TSOP II, Tape & Reel	Automotive-A
	CY7C1011G30-10BAJXE	2.2 V–3.6 V	001-85259	48-ball VFBGA	Automotive-E
	CY7C1011G30-10BAJXET	2.2 V–3.6 V	001-85259	48-ball VFBGA, Tape & Reel	Automotive-E
12	CY7C1011G30-12ZSXE	2.2 V–3.6 V	51-85087	44-pin TSOP II	Automotive-E
	CY7C1011G30-12ZSXET	2.2 V–3.6 V	51-85087	44-pin TSOP II, Tape & Reel	Automotive-E

Ordering Code Definitions

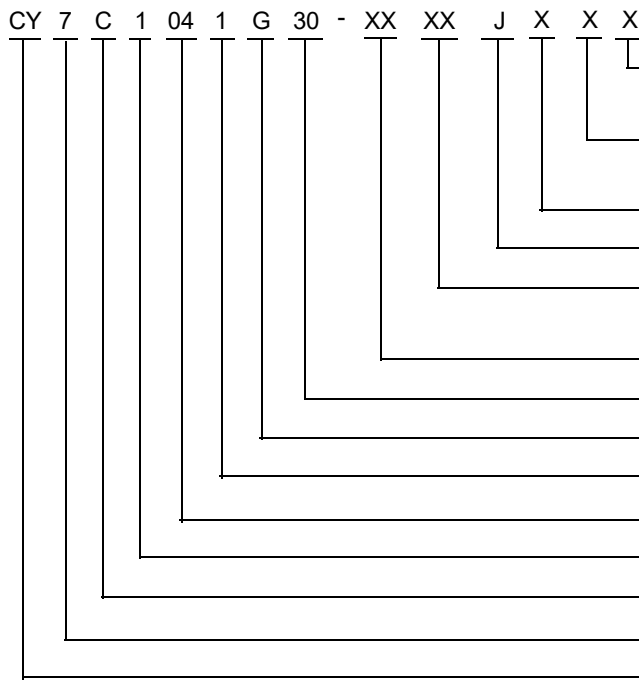

- X = blank or T
blank = Bulk; T = Tape and Reel
- Temperature Range: X = A or E
A = Automotive-A; E = Automotive-E
- Pb-free
- J = JEDEC Compliant (only for BGA package)
- Package Type: XX = BA or ZS
BA = 48-ball VFBGA; ZS = 44-pin TSOP II
- Speed: XX = 10 ns or 12 ns
- Voltage Range: 30 = 2.2 V–3.6 V
- Process Technology: Revision Code “G” = 65 nm Technology
- Data Width: 1 = × 16-bits
- Density: 04 = 4-Mbit
- Family Code: 1 = Fast Asynchronous SRAM family
- Technology Code: C = CMOS
- Marketing Code: 7 = SRAM
- Company ID: CY = Cypress

Package Diagrams

Figure 11. 48-ball VFBGA ((6 × 8 × 1.2 mm) 0.35 mm Ball Diameter) Package Outline, 001-85259

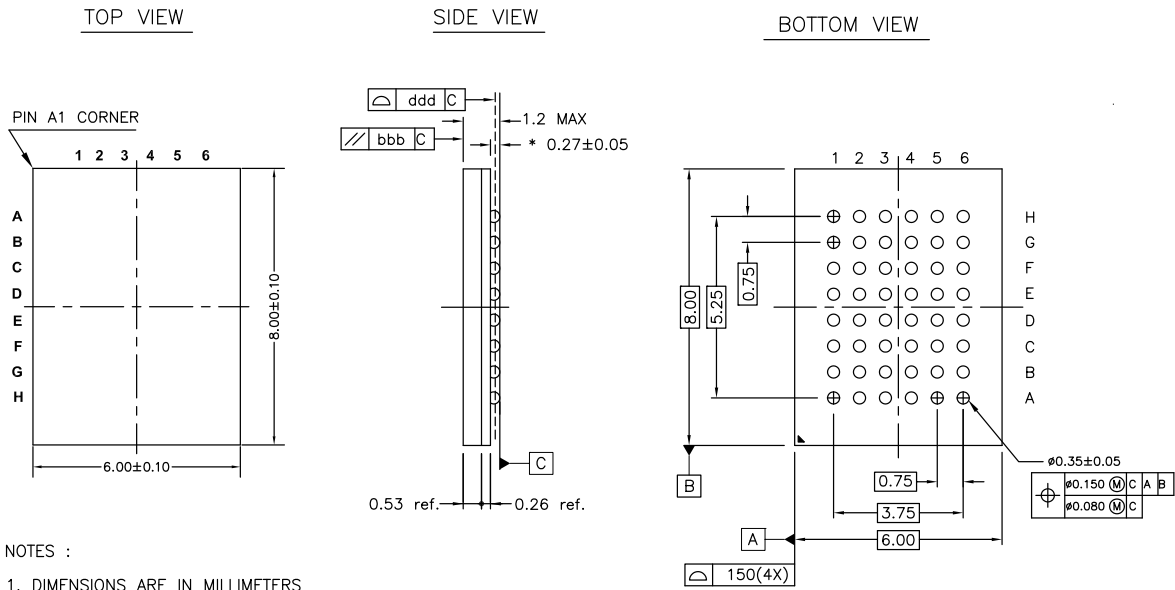

- NOTES :
1. DIMENSIONS ARE IN MILLIMETERS
 2. REFERENCE JEDEC STD : MO-216
 3. * 0.32 ± 0.05 FOR RAMTRON DEVICES

001-85259 *A

Package Diagrams (continued)

Figure 12. 44-pin TSOP II Package Outline, 51-85087

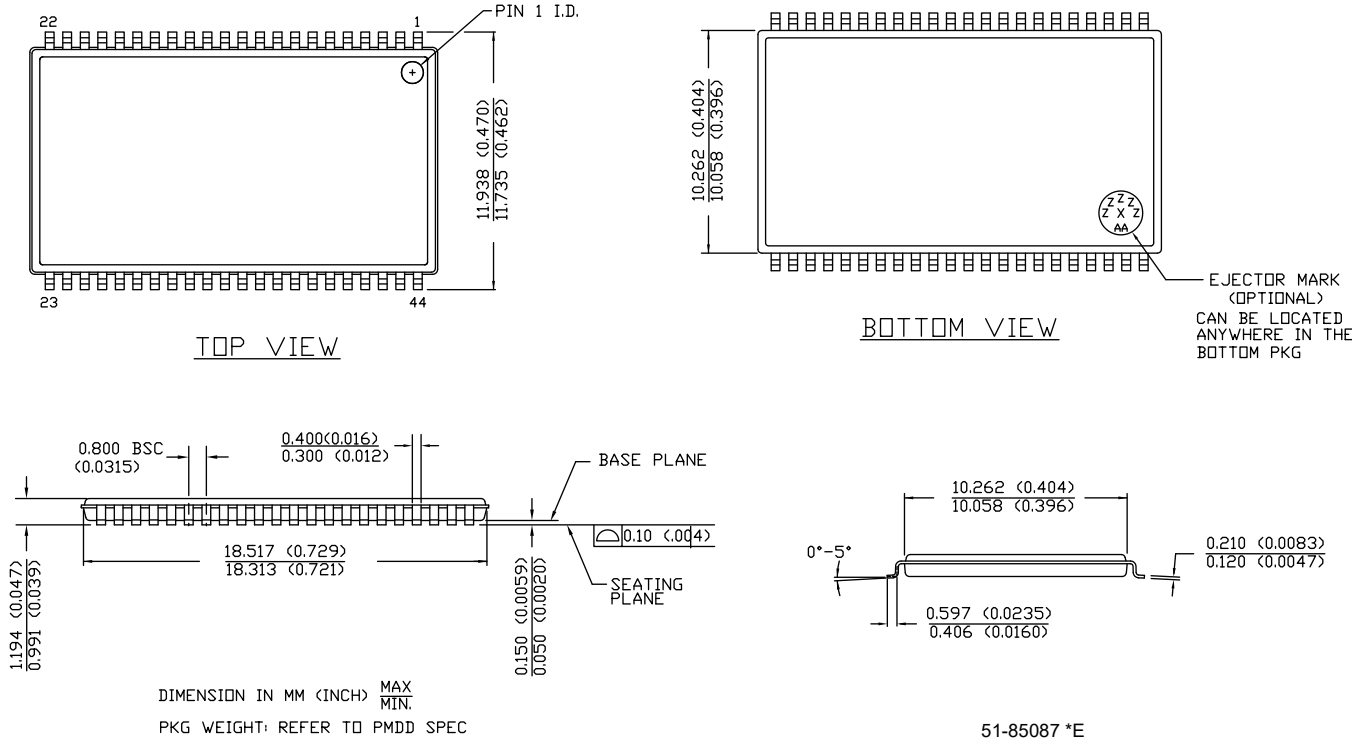

Acronyms

Acronym	Description
$\overline{\text{BHE}}$	Byte High Enable
$\overline{\text{BLE}}$	Byte Low Enable
$\overline{\text{CE}}$	Chip Enable
CMOS	Complementary Metal Oxide Semiconductor
I/O	Input/Output
$\overline{\text{OE}}$	Output Enable
SRAM	Static Random Access Memory
TSOP	Thin Small Outline Package
TTL	Transistor-Transistor Logic
VFBGA	Very Fine-Pitch Ball Grid Array
$\overline{\text{WE}}$	Write Enable

Document Conventions

Units of Measure

Symbol	Unit of Measure
°C	degrees Celsius
MHz	megahertz
μA	microampere
μs	microsecond
mA	milliampere
mm	millimeter
ns	nanosecond
Ω	ohm
%	percent
pF	picofarad
V	volt
W	watt

Document History Page

Document Title: CY7C1011G Automotive, 2-Mbit (128K words × 16-bit) Static RAM with Error-Correcting Code (ECC) Document Number: 001-95423				
Rev.	ECN No.	Orig. of Change	Submission Date	Description of Change
*A	4998910	NILE	11/02/2015	Changed status from Preliminary to Final.
*B	5024020	NILE	11/23/2015	Updated Ordering Information : Updated part numbers.
*C	5692050	NILE	04/27/2017	Added 12 ns speed bin related information in all instances across the document. Updated Features : Added "AEC-Q100 qualified". Updated DC Electrical Characteristics : Removed details of V _{OH} parameter corresponding to "2.7 V to 3.6 V". Added details of V _{OH} parameter corresponding to "2.7 V to 3.0 V" and "3.0 V to 3.6 V". Updated Note 5 (Replaced "2 ns" with "20 ns"). Updated Ordering Information : Updated part numbers. Updated to new template. Completing Sunset Review.
*D	5725360	NILE	05/03/2017	Updated Ordering Information : Updated part numbers.
*E	6142440	NILE	04/17/2018	Updated Features : Added Note 2 and referred the same note in "Embedded error-correcting code (ECC) for single-bit error correction".
*F	6560693	NILE	04/29/2019	Updated to new template.

Sales, Solutions, and Legal Information

Worldwide Sales and Design Support

Cypress maintains a worldwide network of offices, solution centers, manufacturer's representatives, and distributors. To find the office closest to you, visit us at [Cypress Locations](#).

Products

Arm® Cortex® Microcontrollers	cypress.com/arm
Automotive	cypress.com/automotive
Clocks & Buffers	cypress.com/clocks
Interface	cypress.com/interface
Internet of Things	cypress.com/iot
Memory	cypress.com/memory
Microcontrollers	cypress.com/mcu
PSoC	cypress.com/psoc
Power Management ICs	cypress.com/pmic
Touch Sensing	cypress.com/touch
USB Controllers	cypress.com/usb
Wireless Connectivity	cypress.com/wireless

PSoC® Solutions

[PSoC 1](#) | [PSoC 3](#) | [PSoC 4](#) | [PSoC 5LP](#) | [PSoC 6 MCU](#)

Cypress Developer Community

[Community](#) | [Projects](#) | [Video](#) | [Blogs](#) | [Training](#) | [Components](#)

Technical Support

cypress.com/support

© Cypress Semiconductor Corporation, 2015–2019. This document is the property of Cypress Semiconductor Corporation and its subsidiaries ("Cypress"). This document, including any software or firmware included or referenced in this document ("Software"), is owned by Cypress under the intellectual property laws and treaties of the United States and other countries worldwide. Cypress reserves all rights under such laws and treaties and does not, except as specifically stated in this paragraph, grant any license under its patents, copyrights, trademarks, or other intellectual property rights. If the Software is not accompanied by a license agreement and you do not otherwise have a written agreement with Cypress governing the use of the Software, then Cypress hereby grants you a personal, non-exclusive, nontransferable license (without the right to sublicense) (1) under its copyright rights in the Software (a) for Software provided in source code form, to modify and reproduce the Software solely for use with Cypress hardware products, only internally within your organization, and (b) to distribute the Software in binary code form externally to end users (either directly or indirectly through resellers and distributors), solely for use on Cypress hardware product units, and (2) under those claims of Cypress's patents that are infringed by the Software (as provided by Cypress, unmodified) to make, use, distribute, and import the Software solely for use with Cypress hardware products. Any other use, reproduction, modification, translation, or compilation of the Software is prohibited.

TO THE EXTENT PERMITTED BY APPLICABLE LAW, CYPRESS MAKES NO WARRANTY OF ANY KIND, EXPRESS OR IMPLIED, WITH REGARD TO THIS DOCUMENT OR ANY SOFTWARE OR ACCOMPANYING HARDWARE, INCLUDING, BUT NOT LIMITED TO, THE IMPLIED WARRANTIES OF MERCHANTABILITY AND FITNESS FOR A PARTICULAR PURPOSE. No computing device can be absolutely secure. Therefore, despite security measures implemented in Cypress hardware or software products, Cypress shall have no liability arising out of any security breach, such as unauthorized access to or use of a Cypress product. CYPRESS DOES NOT REPRESENT, WARRANT, OR GUARANTEE THAT CYPRESS PRODUCTS, OR SYSTEMS CREATED USING CYPRESS PRODUCTS, WILL BE FREE FROM CORRUPTION, ATTACK, VIRUSES, INTERFERENCE, HACKING, DATA LOSS OR THEFT, OR OTHER SECURITY INTRUSION (collectively, "Security Breach"). Cypress disclaims any liability relating to any Security Breach, and you shall and hereby do release Cypress from any claim, damage, or other liability arising from any Security Breach. In addition, the products described in these materials may contain design defects or errors known as errata which may cause the product to deviate from published specifications. To the extent permitted by applicable law, Cypress reserves the right to make changes to this document without further notice. Cypress does not assume any liability arising out of the application or use of any product or circuit described in this document. Any information provided in this document, including any sample design information or programming code, is provided only for reference purposes. It is the responsibility of the user of this document to properly design, program, and test the functionality and safety of any application made of this information and any resulting product. "High-Risk Device" means any device or system whose failure could cause personal injury, death, or property damage. Examples of High-Risk Devices are weapons, nuclear installations, surgical implants, and other medical devices. "Critical Component" means any component of a High-Risk Device whose failure to perform can be reasonably expected to cause, directly or indirectly, the failure of the High-Risk Device, or to affect its safety or effectiveness. Cypress is not liable, in whole or in part, and you shall and hereby do release Cypress from any claim, damage, or other liability arising from any use of a Cypress product as a Critical Component in a High-Risk Device. You shall indemnify and hold Cypress, its directors, officers, employees, agents, affiliates, distributors, and assigns harmless from and against all claims, costs, damages, and expenses, arising out of any claim, including claims for product liability, personal injury or death, or property damage arising from any use of a Cypress product as a Critical Component in a High-Risk Device. Cypress products are not intended or authorized for use as a Critical Component in any High-Risk Device except to the limited extent that (i) Cypress's published data sheet for the product explicitly states Cypress has qualified the product for use in a specific High-Risk Device, or (ii) Cypress has given you advance written authorization to use the product as a Critical Component in the specific High-Risk Device and you have signed a separate indemnification agreement.

Cypress, the Cypress logo, Spansion, the Spansion logo, and combinations thereof, WICED, PSoC, CapSense, EZ-USB, F-RAM, and Traveo are trademarks or registered trademarks of Cypress in the United States and other countries. For a more complete list of Cypress trademarks, visit cypress.com. Other names and brands may be claimed as property of their respective owners.