

HW Power-On / USB Suspend WP

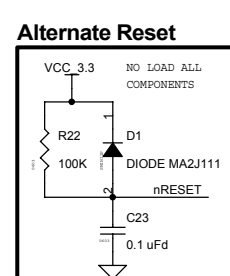

NAND Flash

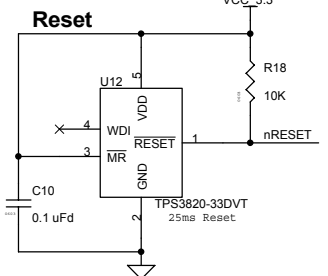
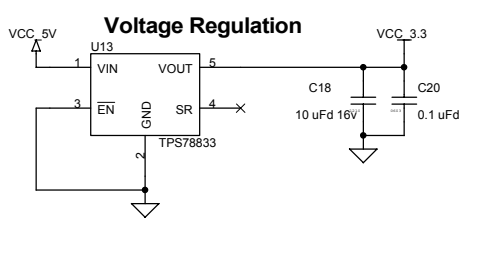
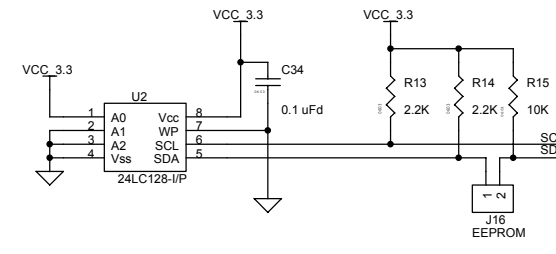
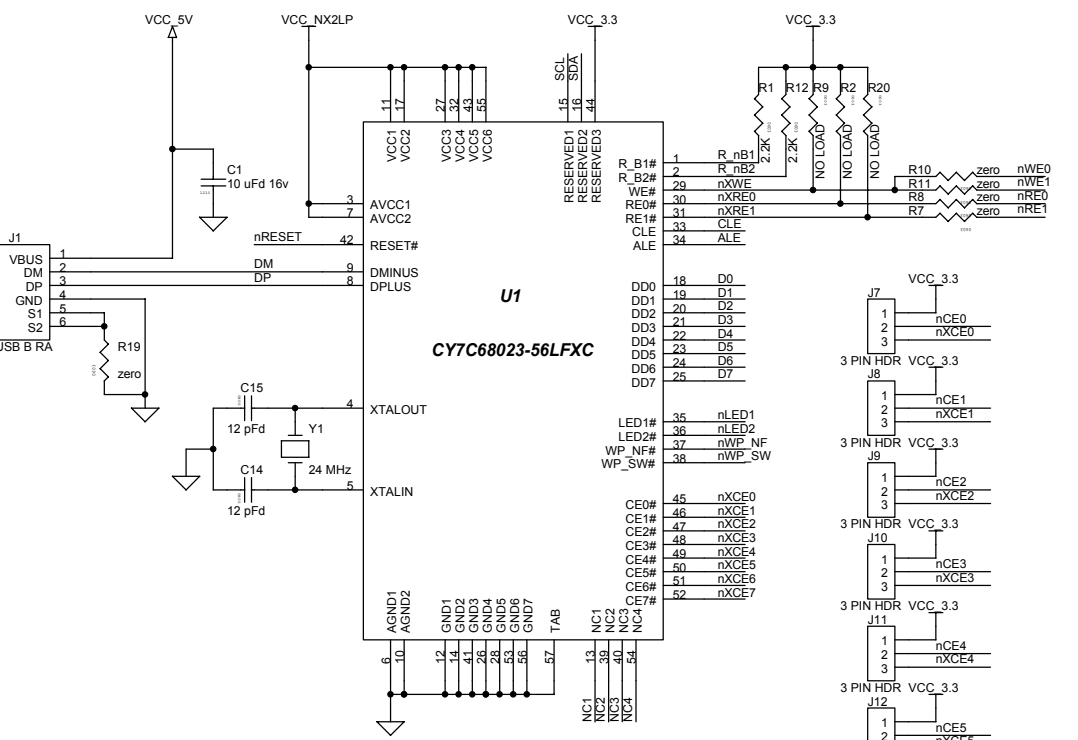
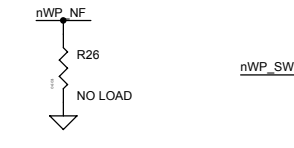
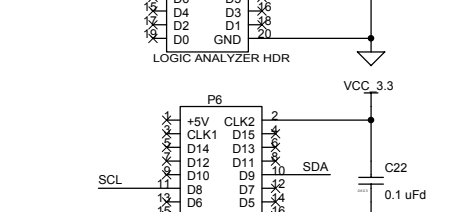
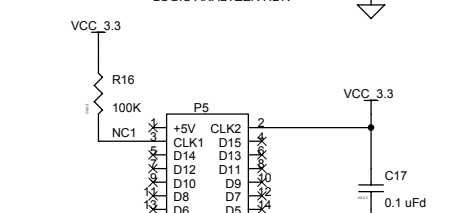
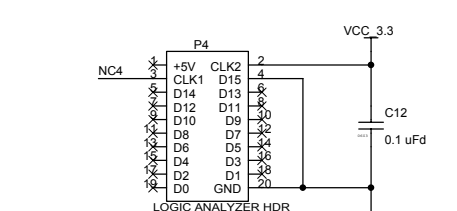
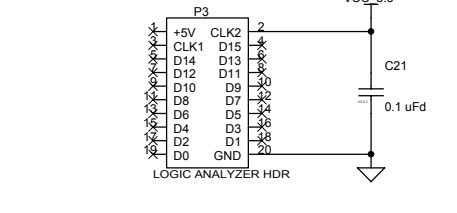
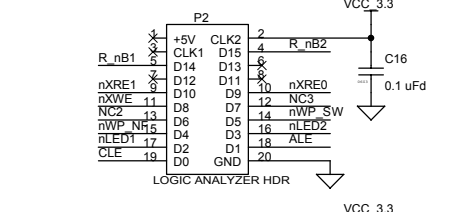
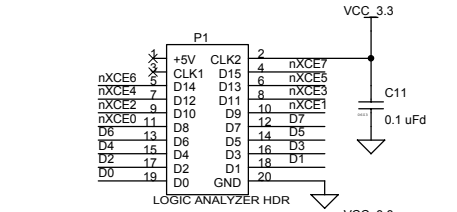
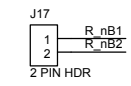
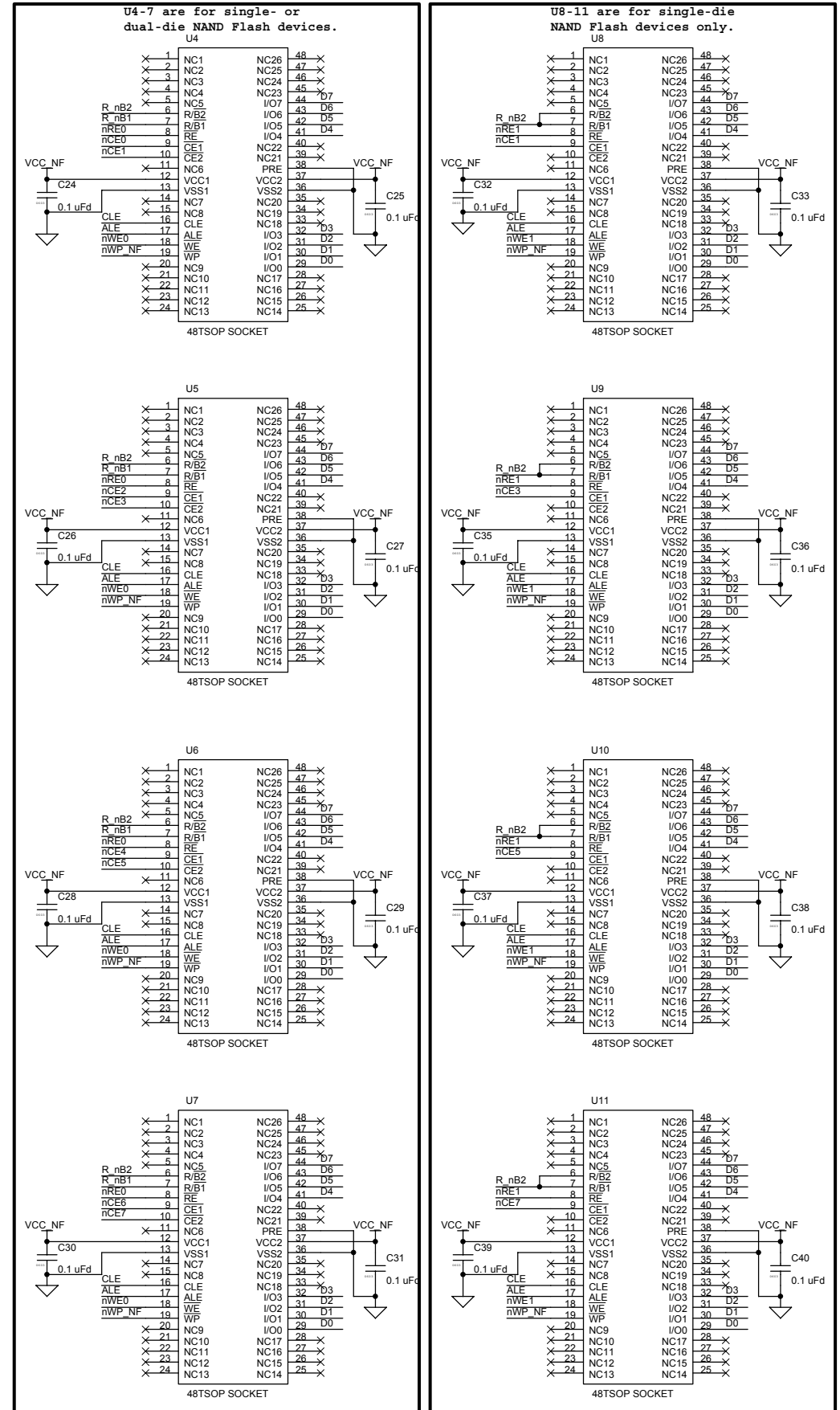

Note: All NAND flash devices must be identical (i.e. same vendor, part number, capacity, package, etc).
 This board supports eight (8) single-die devices or four (4) dual-die NAND flash devices.