

BFP760

SiGe:C NPN RF bipolar transistor



Product description

The BFP760 is a wideband NPN RF heterojunction bipolar transistor (HBT).



Feature list

- Low noise figure $NF_{min} = 0.95$ dB at 5.5 GHz, 3 V, 10 mA
- High gain $G_{ms} = 16.5$ dB at 5.5 GHz, 3 V, 30 mA
- $OIP_3 = 27$ dBm at 5.5 GHz, 3 V, 30 mA

Product validation

Qualified for industrial applications according to the relevant tests of JEDEC JESD47, JESD22, and J-STD-020. Qualified for industrial applications according to the relevant tests of AEC-Q 101.

Potential applications

- Wireless communications: WLAN, WiMAX and UWB
- Satellite communication systems: GNSS navigation systems (GPS, GLONASS, BeiDou, Galileo), satellite radio (SDARs, DAB) and C-band LNB
- Multimedia applications such as mobile/portable TV, CATV and FM radio
- ISM applications like RKE, AMR and Zigbee, as well as for emerging wireless applications

Device information

Table 1 Part information

Product name / Ordering code	Package	Pin configuration				Marking	Pieces / Reel
BFP760 / BFP760H6327XTSA1	SOT343	1 = B	2 = E	3 = C	4 = E	R6s	3000

Attention: ESD (Electrostatic discharge) sensitive device, observe handling precautions

Table of contents

	Product description	1
	Feature list	1
	Product validation	1
	Potential applications	1
	Device information	1
	Table of contents	2
1	Absolute maximum ratings	3
2	Thermal characteristics	4
3	Electrical characteristics	5
3.1	DC characteristics	5
3.2	General AC characteristics	5
3.3	Frequency dependent AC characteristics	6
3.4	Characteristic DC diagrams	9
3.5	Characteristic AC diagrams	12
4	Package information SOT343	19
	Revision history	20
	Disclaimer	21

Absolute maximum ratings

1 Absolute maximum ratings

Table 2 Absolute maximum ratings at $T_A = 25\text{ °C}$ (unless otherwise specified)

Parameter	Symbol	Values		Unit	Note or test condition	
		Min.	Max.			
Collector emitter voltage	V_{CEO}	-	4.0	V	Open base	
			3.5		$T_A = -55\text{ °C}$, open base	
Collector emitter voltage	V_{CES}		13		E-B short circuited	
Collector base voltage	V_{CBO}		13		Open emitter	
Emitter base voltage	V_{EBO}		1.2		Open collector	
Base current	I_B		4		mA	-
Collector current	I_C		70			
Total power dissipation ¹⁾	P_{tot}		240	mW	$T_S \leq 95\text{ °C}$	
Junction temperature	T_J		150	°C	-	
Storage temperature	T_{Stg}	-55				

Attention: *Stresses above the max. values listed here may cause permanent damage to the device. Exposure to absolute maximum rating conditions for extended periods may affect device reliability. Exceeding only one of these values may cause irreversible damage to the integrated circuit.*

¹ T_S is the soldering point temperature. T_S is measured on the emitter lead at the soldering point of the PCB.

Thermal characteristics

2 Thermal characteristics

Table 3 Thermal resistance

Parameter	Symbol	Values			Unit	Note or test condition
		Min.	Typ.	Max.		
Junction - soldering point	R_{thJS}	-	230	-	K/W	-

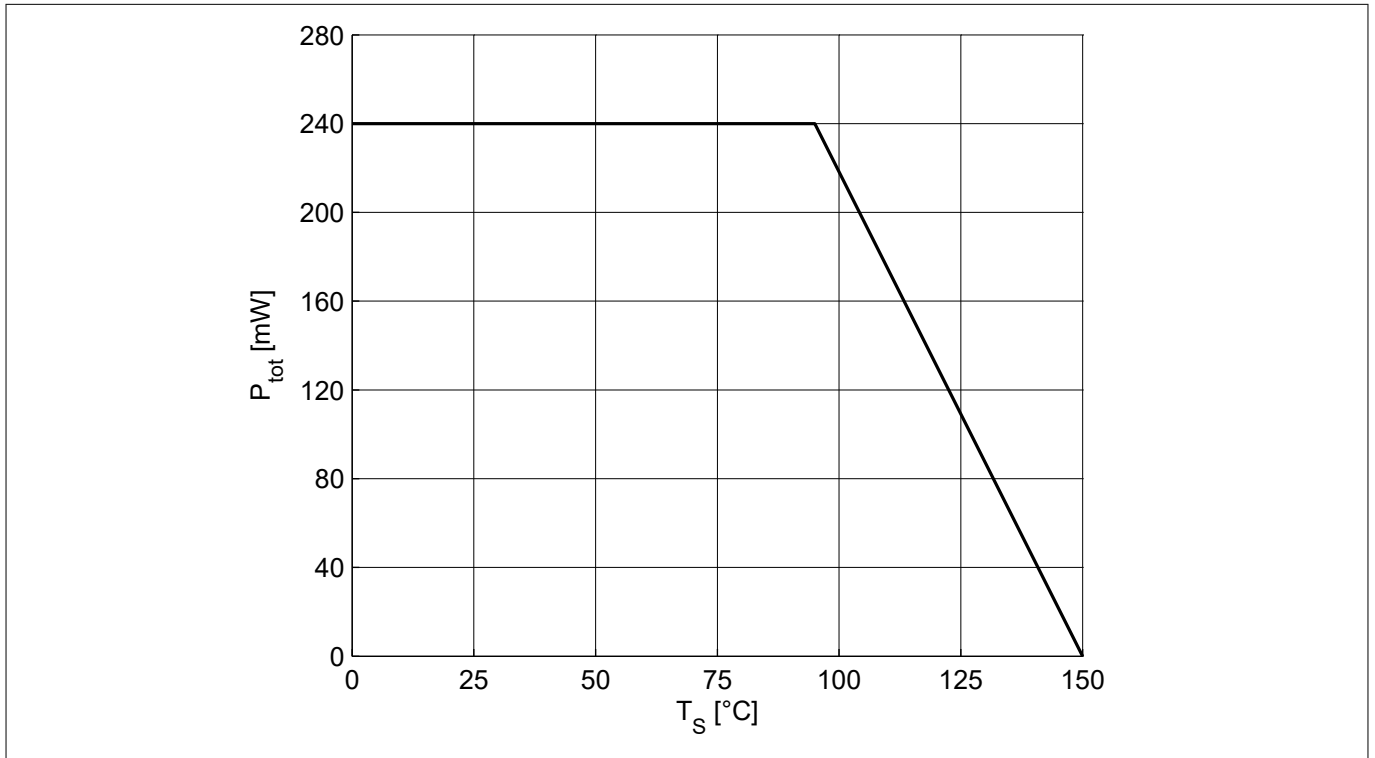

Figure 1 Total power dissipation $P_{tot} = f(T_S)$

Electrical characteristics

3 Electrical characteristics

3.1 DC characteristics

Table 4 DC characteristics at $T_A = 25\text{ °C}$

Parameter	Symbol	Values			Unit	Note or test condition
		Min.	Typ.	Max.		
Collector emitter breakdown voltage	$V_{(BR)CEO}$	4	4.7	–	V	$I_C = 1\text{ mA}$, $I_B = 0$, open base
Collector emitter leakage current	I_{CES}	–	10 1	400 ²⁾ 40 ²⁾	nA	$V_{CE} = 13\text{ V}$, $V_{BE} = 0$ $V_{CE} = 5\text{ V}$, $V_{BE} = 0$ E-B short circuited
Collector base leakage current	I_{CBO}		1	40 ²⁾		$V_{CB} = 5\text{ V}$, $I_E = 0$, open emitter
Emitter base leakage current	I_{EBO}		1	40 ²⁾		$V_{EB} = 0.5\text{ V}$, $I_C = 0$, open collector
DC current gain	h_{FE}	160	250	400		$V_{CE} = 3\text{ V}$, $I_C = 35\text{ mA}$, pulse measured

3.2 General AC characteristics

Table 5 General AC characteristics at $T_A = 25\text{ °C}$

Parameter	Symbol	Values			Unit	Note or test condition	
		Min.	Typ.	Max.			
Transition frequency	f_T	–	45	–	GHz	$V_{CE} = 3\text{ V}$, $I_C = 35\text{ mA}$, $f = 1\text{ GHz}$	
Collector base capacitance	C_{CB}		0.13	0.2		pF	$V_{CB} = 3\text{ V}$, $V_{BE} = 0$, $f = 1\text{ MHz}$, emitter grounded
Collector emitter capacitance	C_{CE}		0.42	–			$V_{CE} = 3\text{ V}$, $V_{BE} = 0$, $f = 1\text{ MHz}$, base grounded
Emitter base capacitance	C_{EB}		0.65				$V_{EB} = 0.5\text{ V}$, $V_{CB} = 0$, $f = 1\text{ MHz}$, collector grounded

² Maximum values not limited by the device but by the short cycle time of the 100% test.

Electrical characteristics

3.3 Frequency dependent AC characteristics

Measurement setup is a test fixture with Bias-T's in a 50 Ω system, $T_A = 25\text{ °C}$.

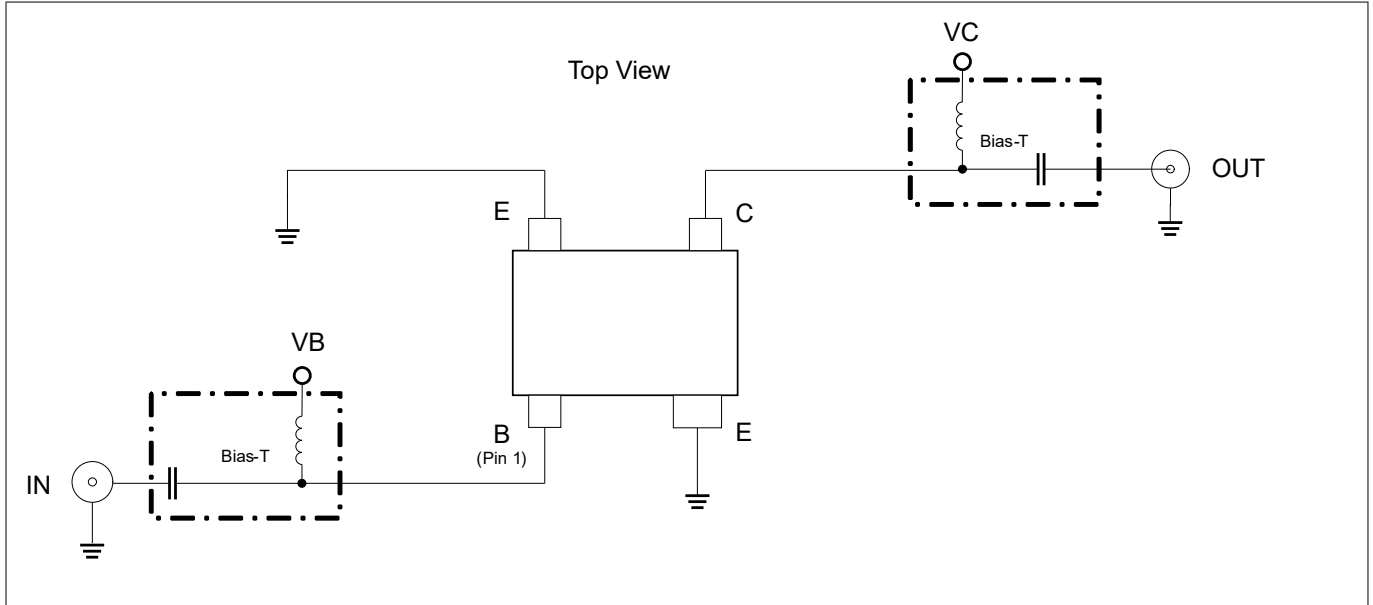

Figure 2 Testing circuit

Table 6 AC characteristics, $V_{CE} = 3\text{ V}$, $f = 900\text{ MHz}$

Parameter	Symbol	Values			Unit	Note or test condition
		Min.	Typ.	Max.		
Power gain		–		–	dB	$I_C = 30\text{ mA}$
<ul style="list-style-type: none"> Maximum power gain Transducer gain 	G_{ms} $ S_{21} ^2$		29 28			
Noise figure					dBm	$I_C = 10\text{ mA}$
<ul style="list-style-type: none"> Minimum noise figure Associated gain 	NF_{min} G_{ass}		0.5 25.5			
Linearity					dBm	$Z_S = Z_L = 50\text{ }\Omega$, $I_C = 30\text{ mA}$
<ul style="list-style-type: none"> 3rd order intercept point at output 1 dB gain compression point at output 	OIP_3 OP_{1dB}		27 14			

Table 7 AC characteristics, $V_{CE} = 3\text{ V}$, $f = 1.8\text{ GHz}$

Parameter	Symbol	Values			Unit	Note or test condition
		Min.	Typ.	Max.		
Power gain		–		–	dB	$I_C = 30\text{ mA}$
<ul style="list-style-type: none"> Maximum power gain Transducer gain 	G_{ms} $ S_{21} ^2$		25 22			
Noise figure					dBm	$I_C = 10\text{ mA}$
<ul style="list-style-type: none"> Minimum noise figure Associated gain 	NF_{min} G_{ass}		0.55 20.5			

(table continues...)

Electrical characteristics

Table 7 (continued) AC characteristics, $V_{CE} = 3\text{ V}$, $f = 1.8\text{ GHz}$

Parameter	Symbol	Values			Unit	Note or test condition
		Min.	Typ.	Max.		
Linearity					dBm	$Z_S = Z_L = 50\ \Omega$, $I_C = 30\text{ mA}$
<ul style="list-style-type: none"> 3rd order intercept point at output 1 dB gain compression point at output 	OIP_3 OP_{1dB}		28 14.5			

Table 8 AC characteristics, $V_{CE} = 3\text{ V}$, $f = 2.4\text{ GHz}$

Parameter	Symbol	Values			Unit	Note or test condition		
		Min.	Typ.	Max.				
Power gain		-		-	dB	$I_C = 30\text{ mA}$		
<ul style="list-style-type: none"> Maximum power gain Transducer gain 	G_{ms} $ S_{21} ^2$		23.5 20					
Noise figure			-			-	dBm	$I_C = 10\text{ mA}$
<ul style="list-style-type: none"> Minimum noise figure Associated gain 	NF_{min} G_{ass}				0.6 19			
Linearity					dBm	$Z_S = Z_L = 50\ \Omega$, $I_C = 30\text{ mA}$		
<ul style="list-style-type: none"> 3rd order intercept point at output 1 dB gain compression point at output 	OIP_3 OP_{1dB}		28 14					

Table 9 AC characteristics, $V_{CE} = 3\text{ V}$, $f = 3.5\text{ GHz}$

Parameter	Symbol	Values			Unit	Note or test condition		
		Min.	Typ.	Max.				
Power gain		-		-	dB	$I_C = 30\text{ mA}$		
<ul style="list-style-type: none"> Maximum power gain Transducer gain 	G_{ms} $ S_{21} ^2$		21.5 16.5					
Noise figure			-			-	dBm	$I_C = 10\text{ mA}$
<ul style="list-style-type: none"> Minimum noise figure Associated gain 	NF_{min} G_{ass}				0.7 16			
Linearity					dBm	$Z_S = Z_L = 50\ \Omega$, $I_C = 30\text{ mA}$		
<ul style="list-style-type: none"> 3rd order intercept point at output 1 dB gain compression point at output 	OIP_3 OP_{1dB}		28.5 14.5					

Electrical characteristics

Table 10 AC characteristics, $V_{CE} = 3\text{ V}$, $f = 5.5\text{ GHz}$

Parameter	Symbol	Values			Unit	Note or test condition
		Min.	Typ.	Max.		
Power gain		-		-	dB	$I_C = 30\text{ mA}$
• Maximum power gain	G_{ma}		16.5			
• Transducer gain	$ S_{21} ^2$		12			
Noise figure						dB
• Minimum noise figure	NF_{min}	0.95				
• Associated gain	G_{ass}	12.5				
Linearity					dBm	$Z_S = Z_L = 50\ \Omega$, $I_C = 30\text{ mA}$
• 3rd order intercept point at output	OIP_3	27				
• 1 dB gain compression point at output	OP_{1dB}	13				

Note: $G_{ms} = |S_{21} / S_{12}|$ for $k < 1$; $G_{ma} = |S_{21} / S_{12}|(k - (k^2 - 1)^{1/2})$ for $k > 1$. In order to get the NF_{min} values stated in this chapter, the test fixture losses have been subtracted from all measured results. OIP_3 value depends on termination of all intermodulation frequency components. Termination used for this measurement is $50\ \Omega$ from 0.2 MHz to 12 GHz.

3.4 Characteristic DC diagrams

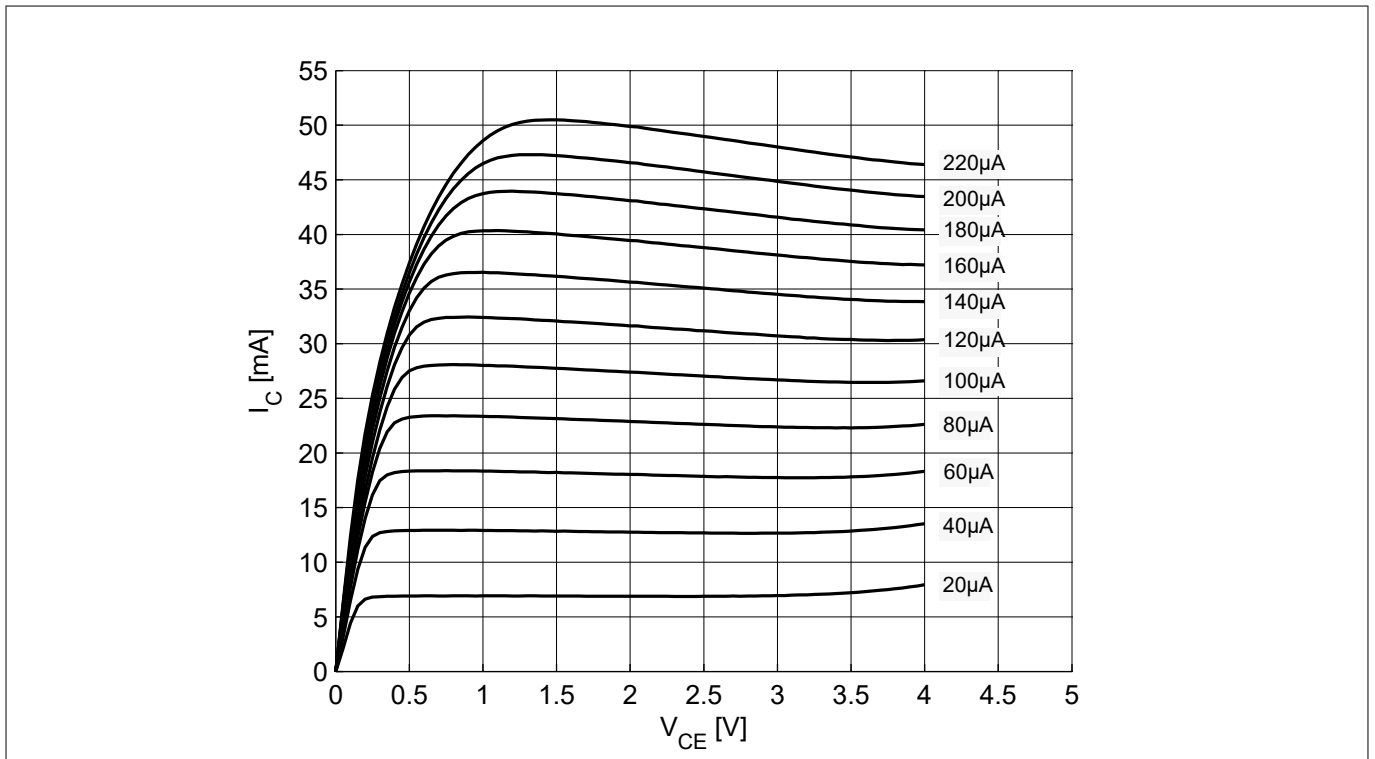

Figure 3 Collector current vs. collector emitter voltage $I_C = f(V_{CE})$, $I_B = \text{parameter}$

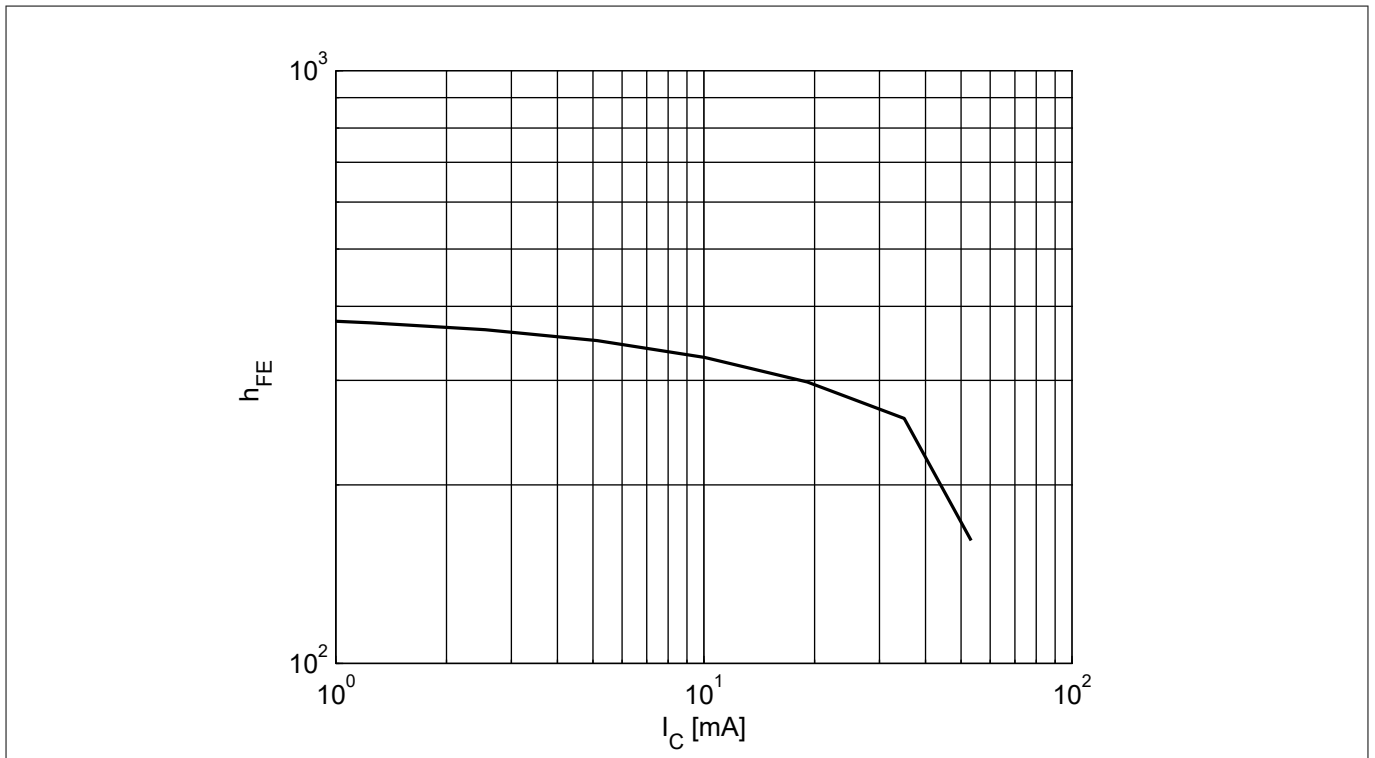

Figure 4 DC current gain $h_{FE} = f(I_C)$, $V_{CE} = 3 \text{ V}$

Electrical characteristics

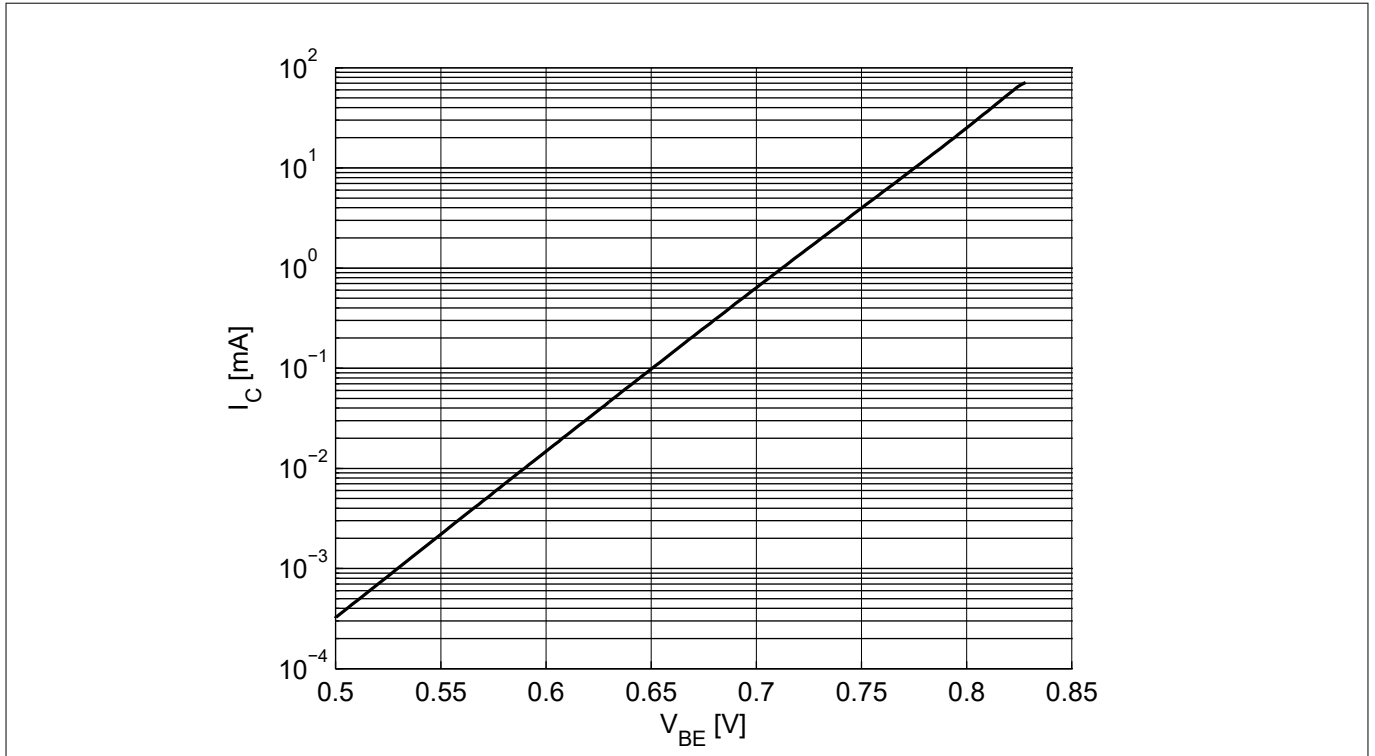

Figure 5 Collector current vs. base emitter forward voltage $I_C = f(V_{BE})$, $V_{CE} = 2\text{ V}$

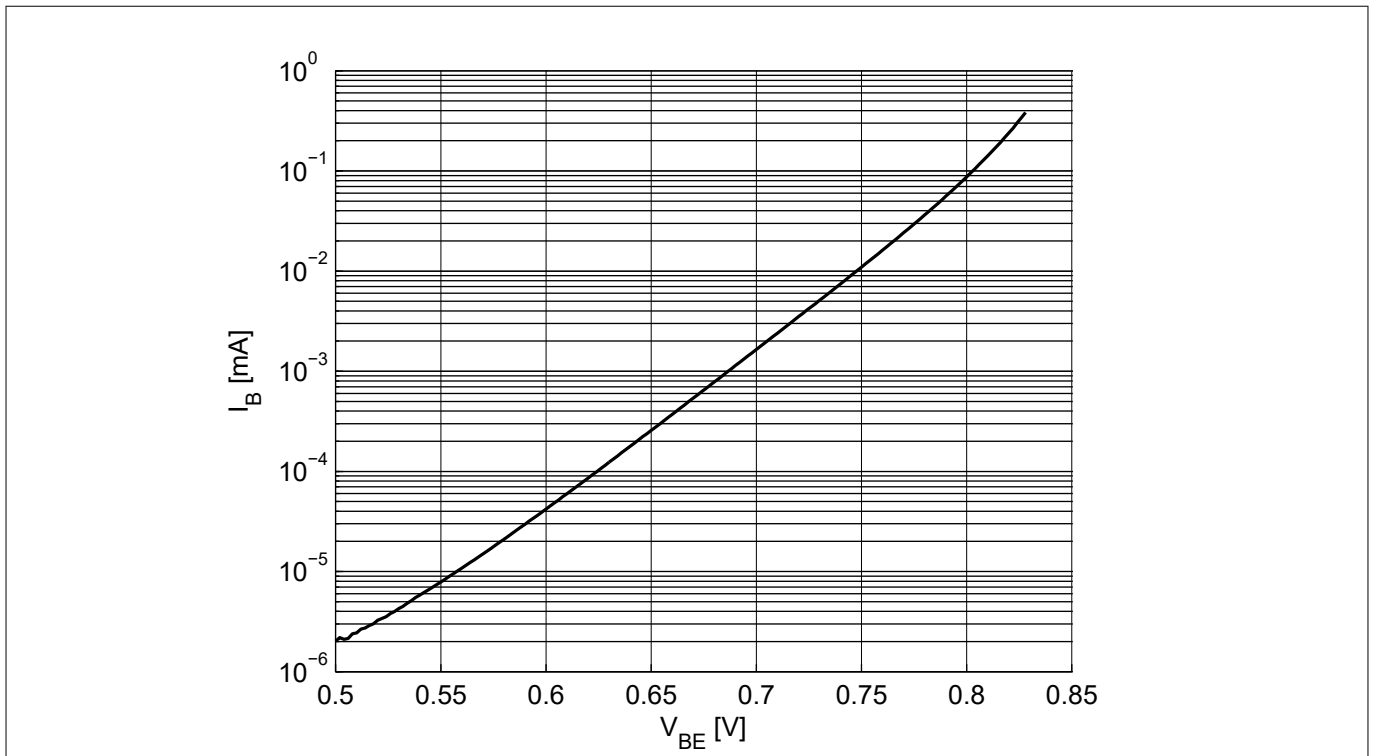

Figure 6 Base current vs. base emitter forward voltage $I_B = f(V_{BE})$, $V_{CE} = 2\text{ V}$

Electrical characteristics

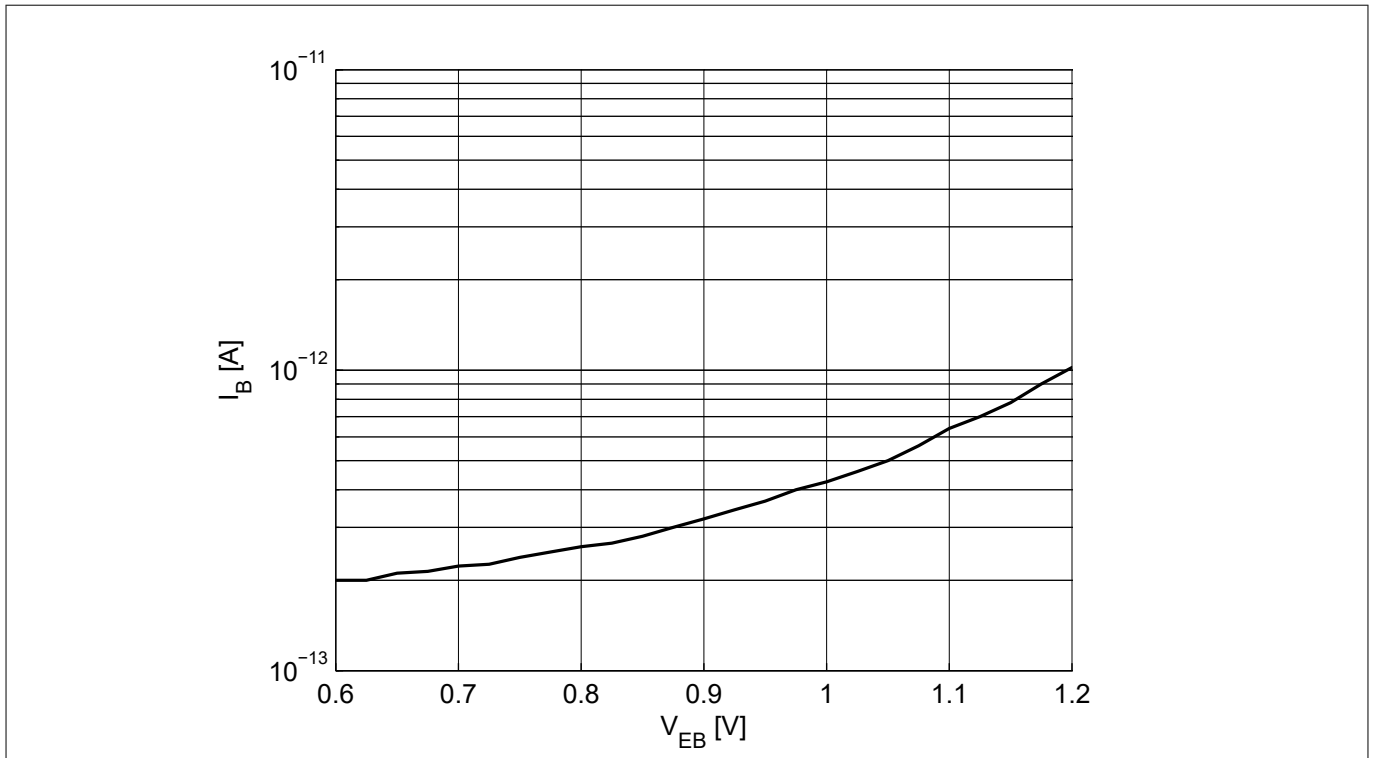

Figure 7 Base current vs. base emitter reverse voltage $I_B = f(V_{EB}), V_{CE} = 2 \text{ V}$

3.5 Characteristic AC diagrams

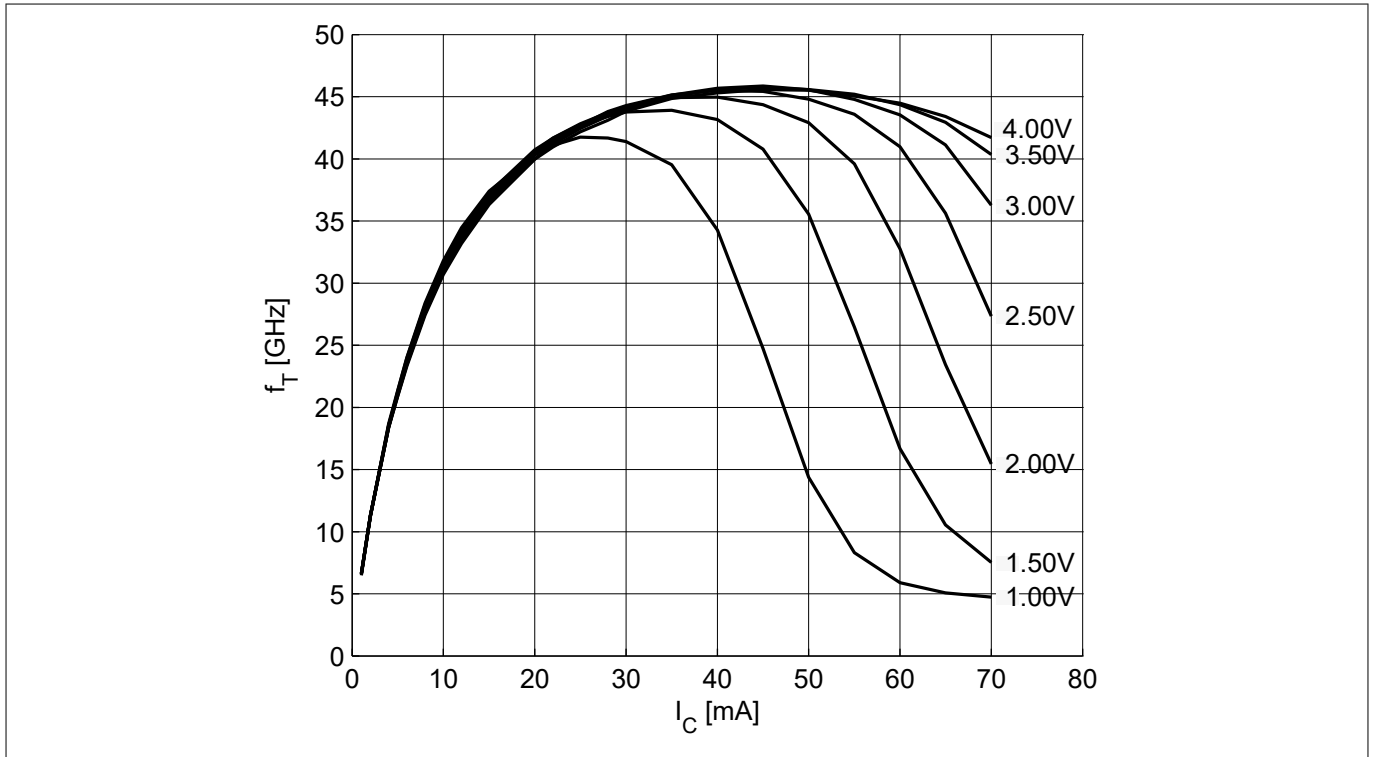

Figure 8 Transition frequency $f_T = f(I_C)$, $f = 1$ GHz, $V_{CE} = \text{parameter}$

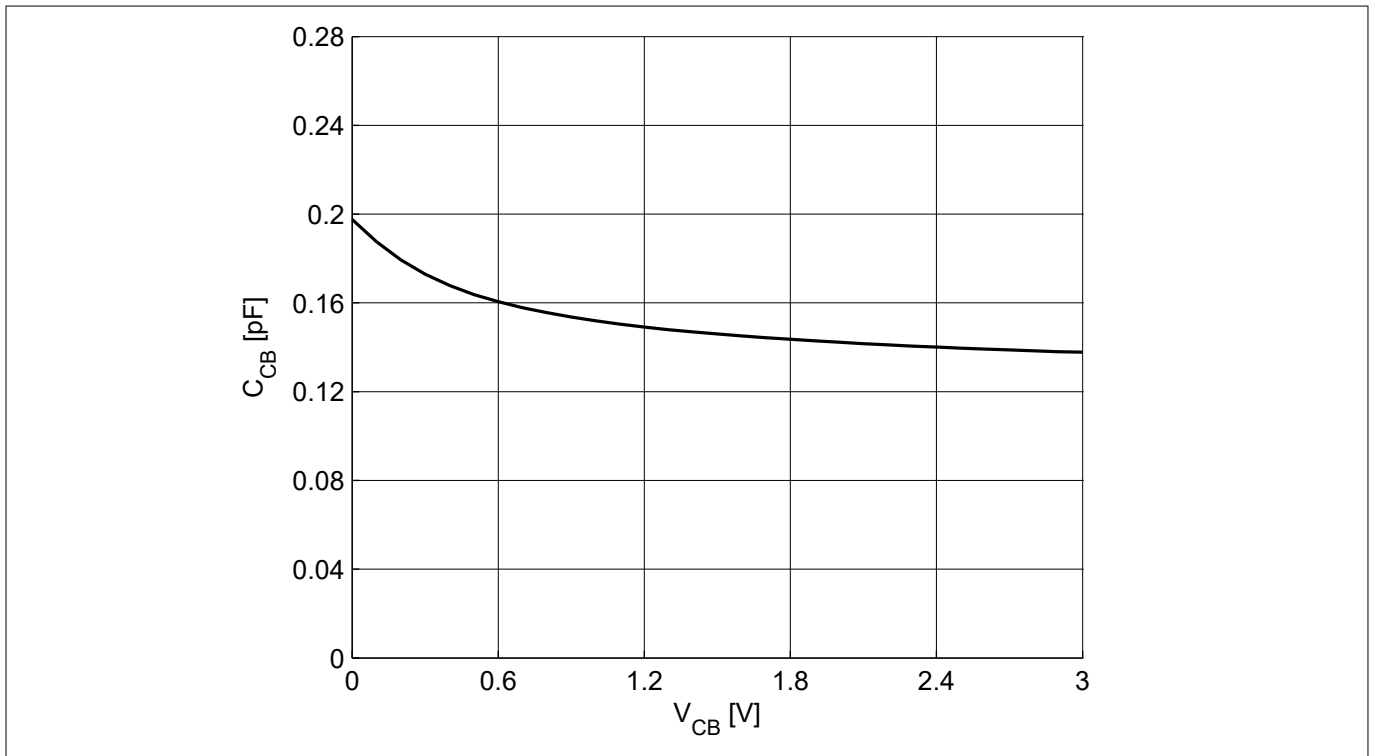

Figure 9 Collector base capacitance $C_{CB} = f(V_{CB})$, $f = 1$ MHz

Electrical characteristics

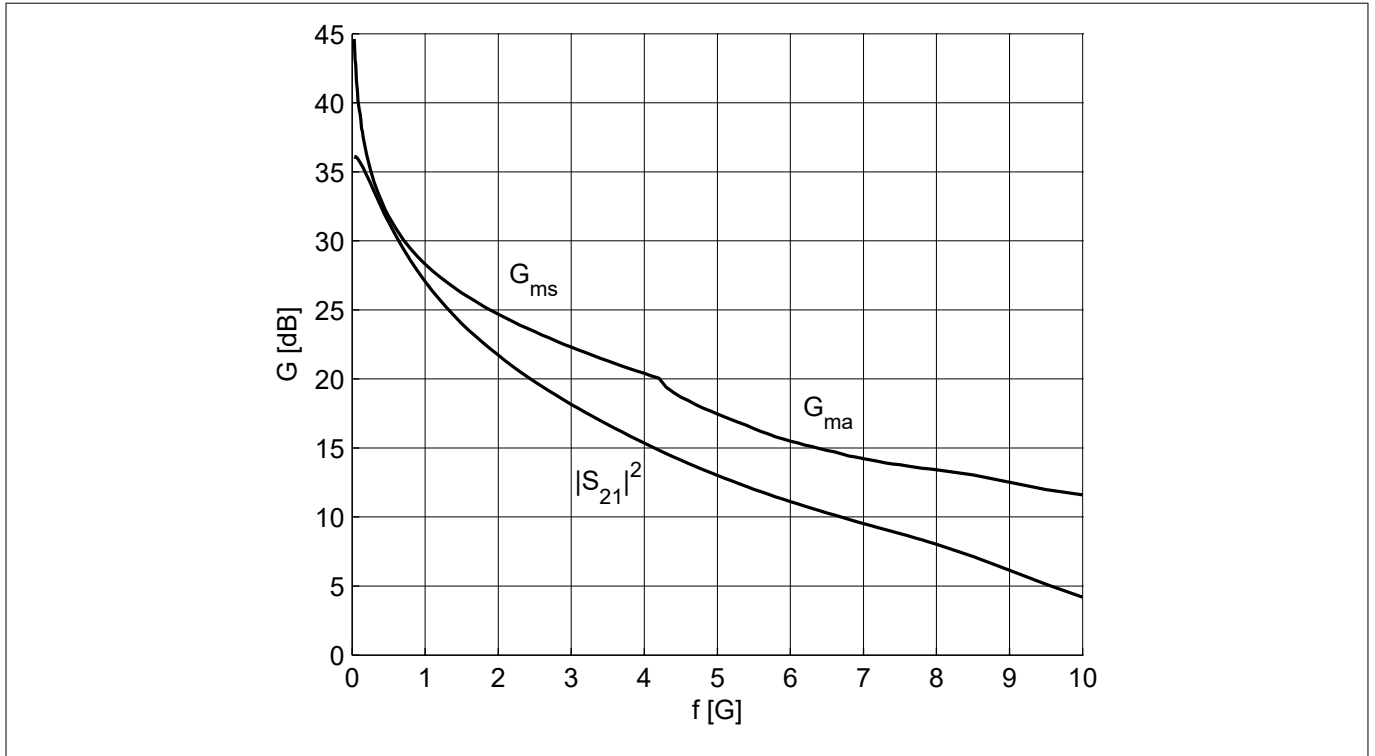

Figure 10 Gain G_{ma} , G_{ms} , $|S_{21}|^2 = f(f)$, $V_{CE} = 3\text{ V}$, $I_C = 30\text{ mA}$

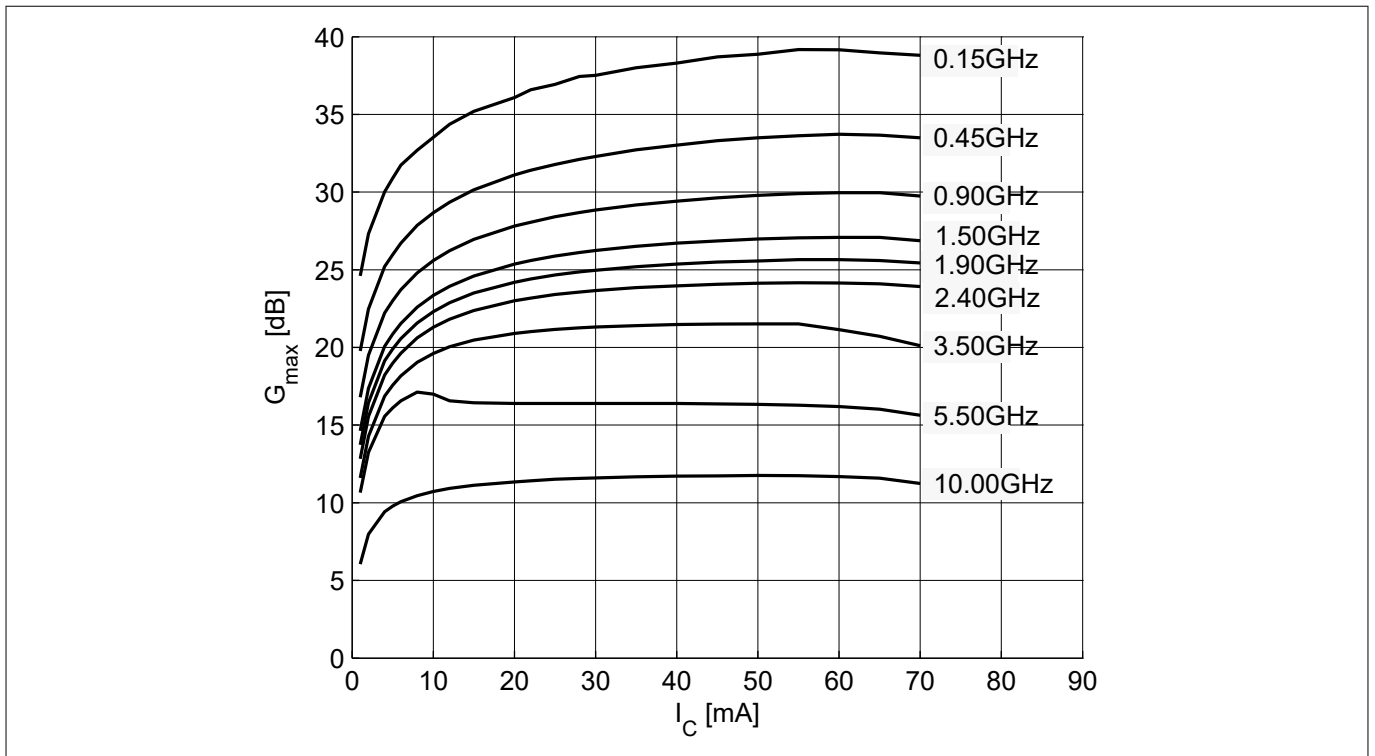

Figure 11 Maximum power gain $G_{max} = f(I_C)$, $V_{CE} = 3\text{ V}$, $f = \text{parameter in GHz}$

Electrical characteristics

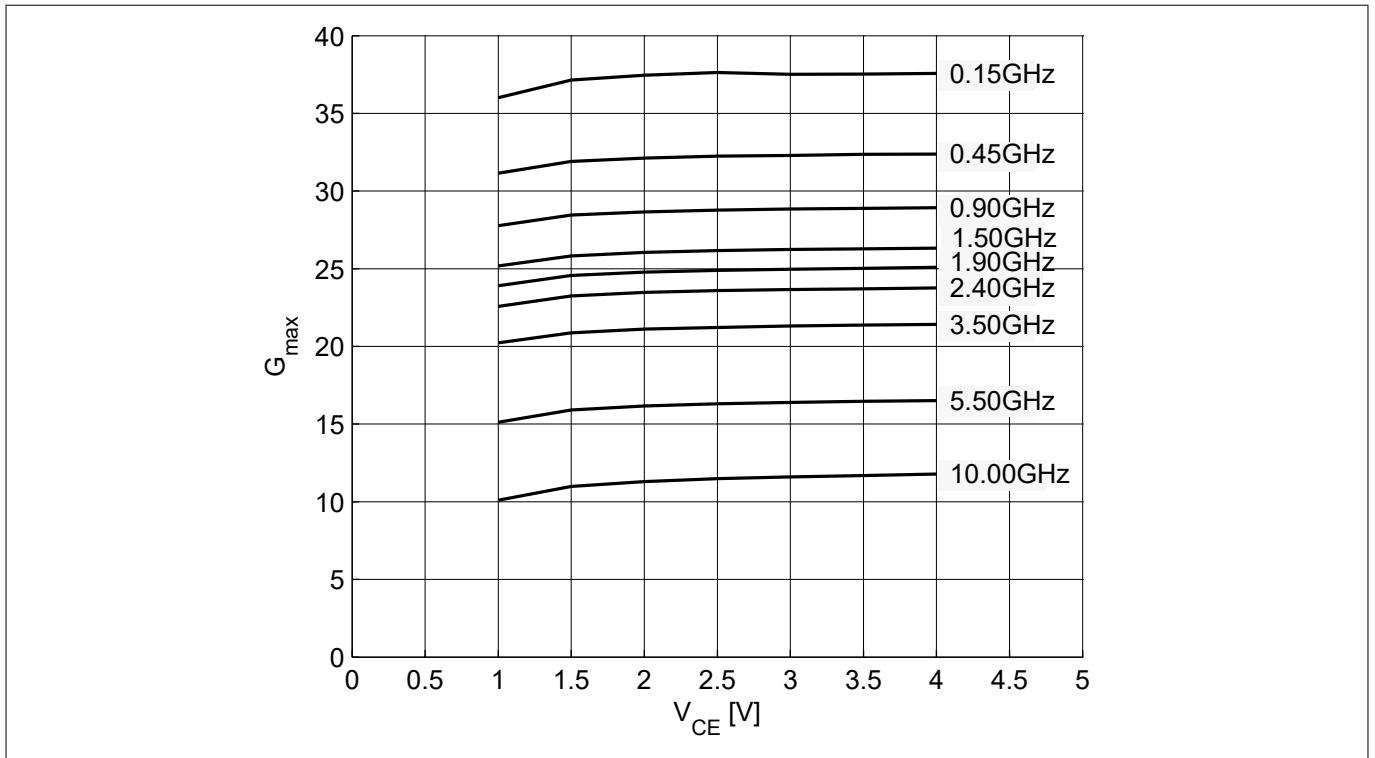

Figure 12 Maximum power gain $G_{max} = f(V_{CE})$, $I_C = 30 \text{ mA}$, $f = \text{parameter in GHz}$

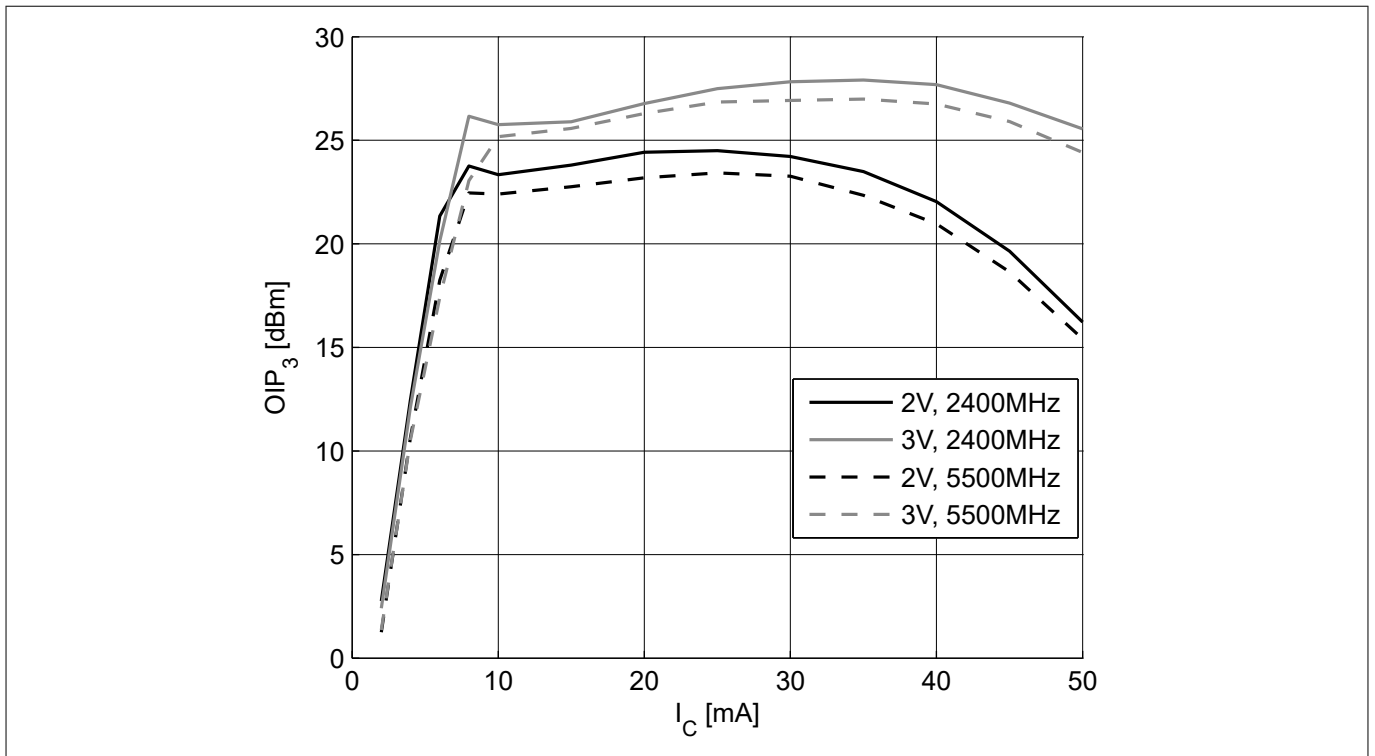

Figure 13 3rd order intercept point at output $OIP_3 = f(I_C)$, $Z_S = Z_L = 50 \Omega$, V_{CE} , $f = \text{parameters}$

Electrical characteristics

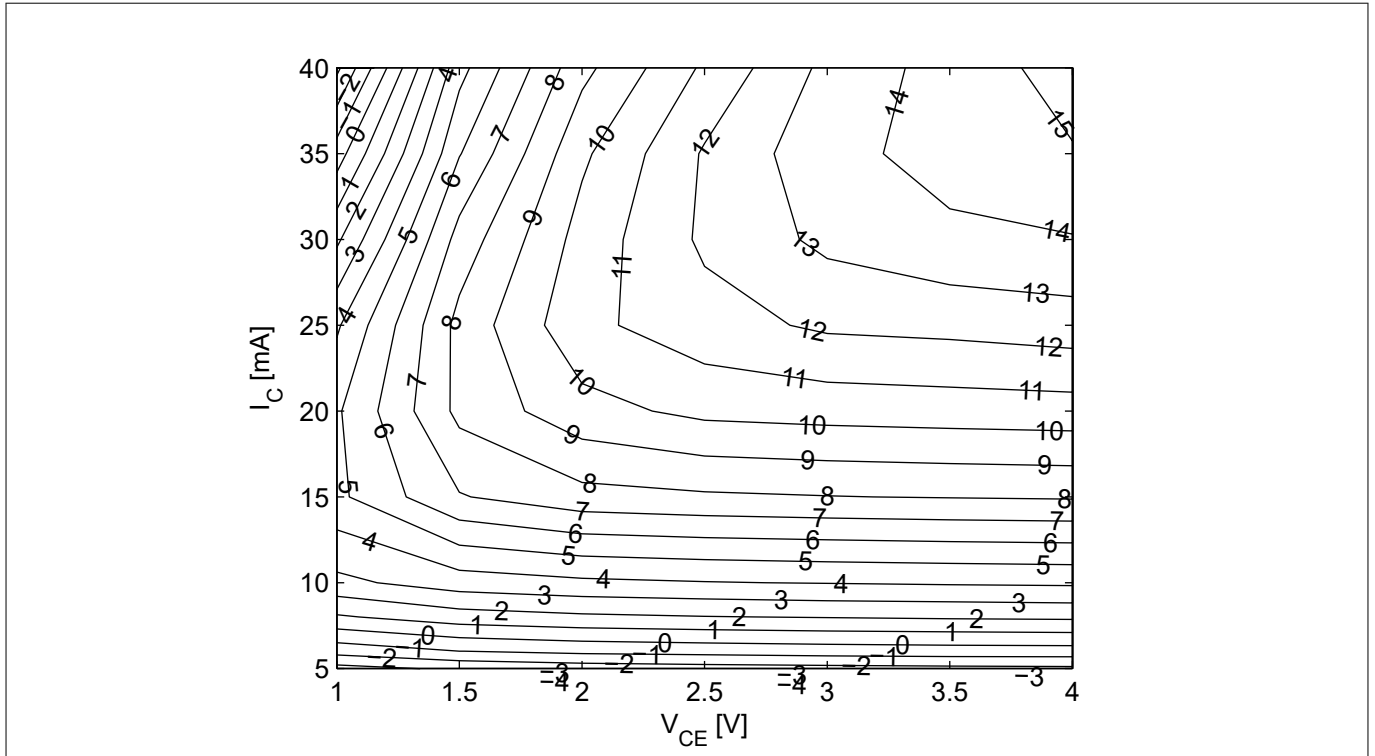

Figure 14 Compression point at output OP_{1dB} [dBm] = $f(I_C, V_{CE})$, $Z_S = Z_L = 50 \Omega$, $f = 5.5$ GHz

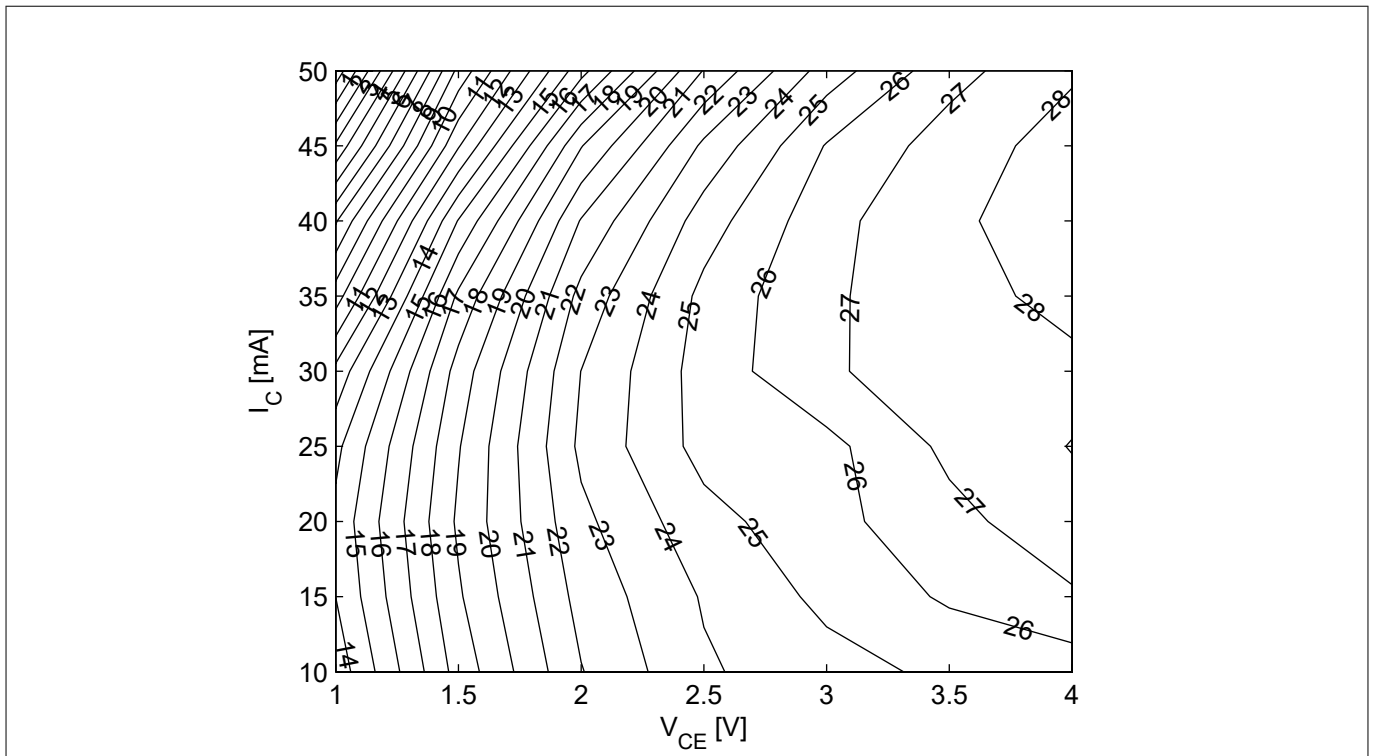

Figure 15 3rd order intercept point at output OIP_3 [dBm] = $f(I_C, V_{CE})$, $Z_S = Z_L = 50 \Omega$, $f = 5.5$ GHz

Electrical characteristics

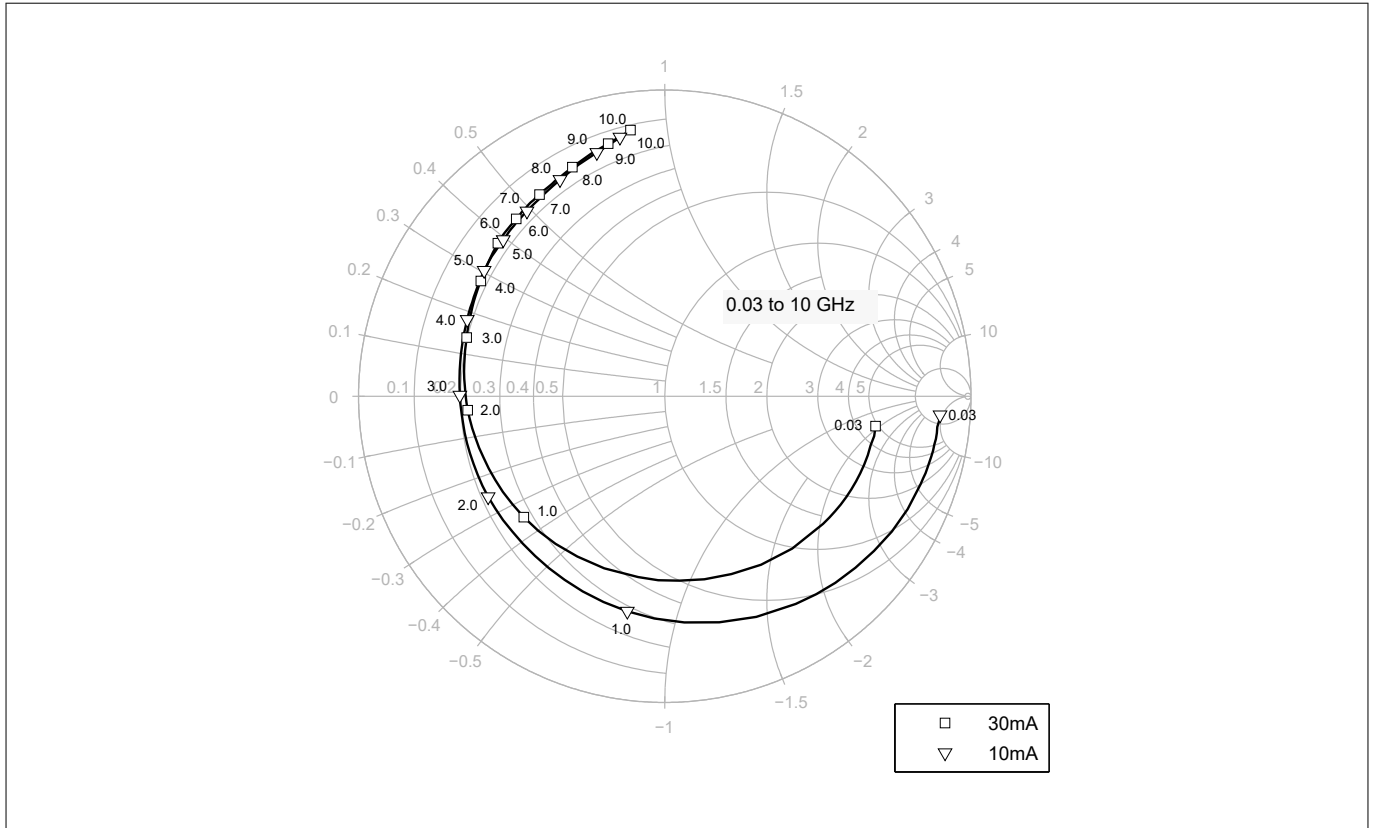

Figure 16 Input reflection coefficient $S_{11} = f(f)$, $V_{CE} = 3\text{ V}$, $I_C = 10 / 30\text{ mA}$

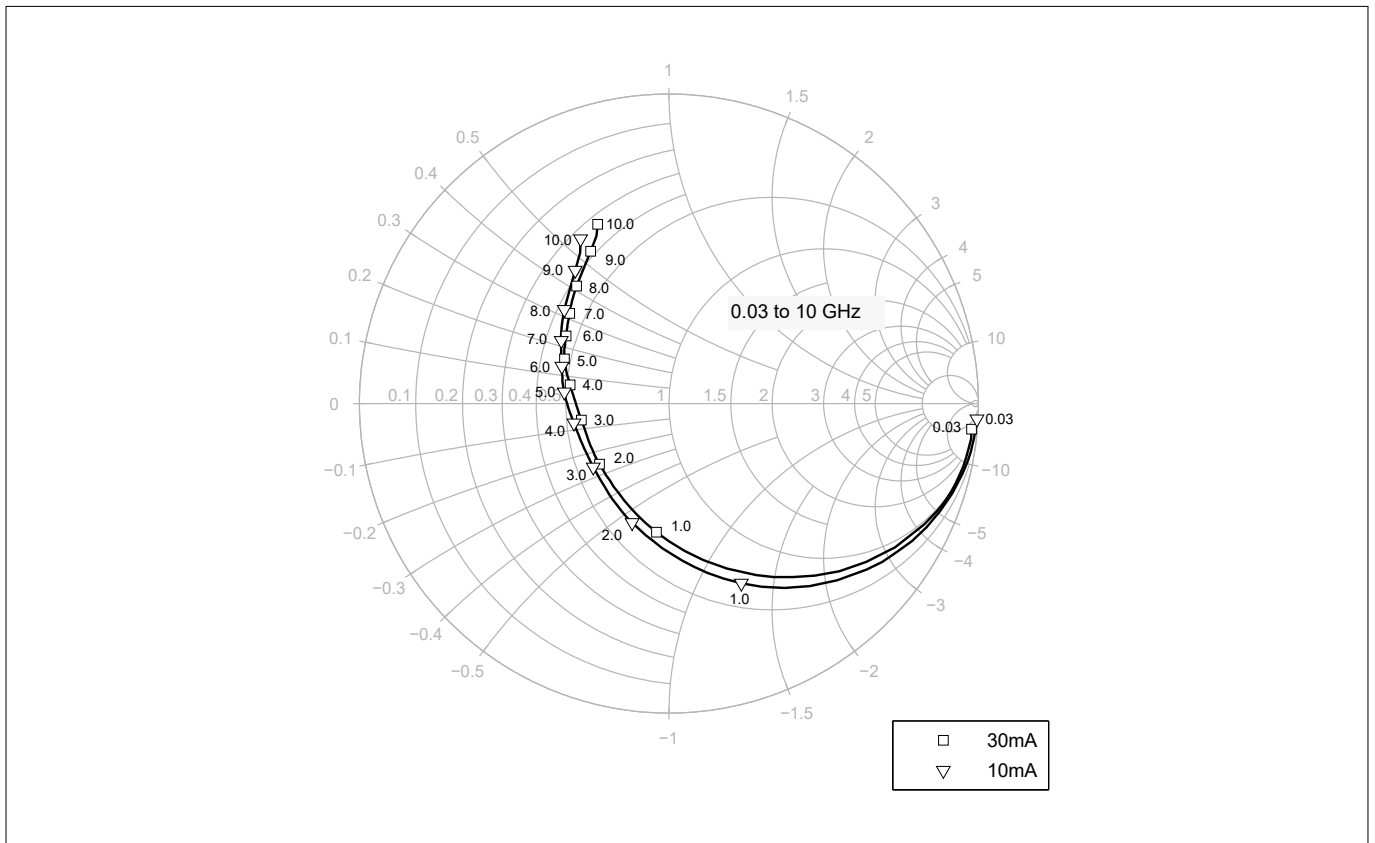

Figure 17 Output reflection coefficient $S_{22} = f(f)$, $V_{CE} = 3\text{ V}$, $I_C = 10 / 30\text{ mA}$

Electrical characteristics

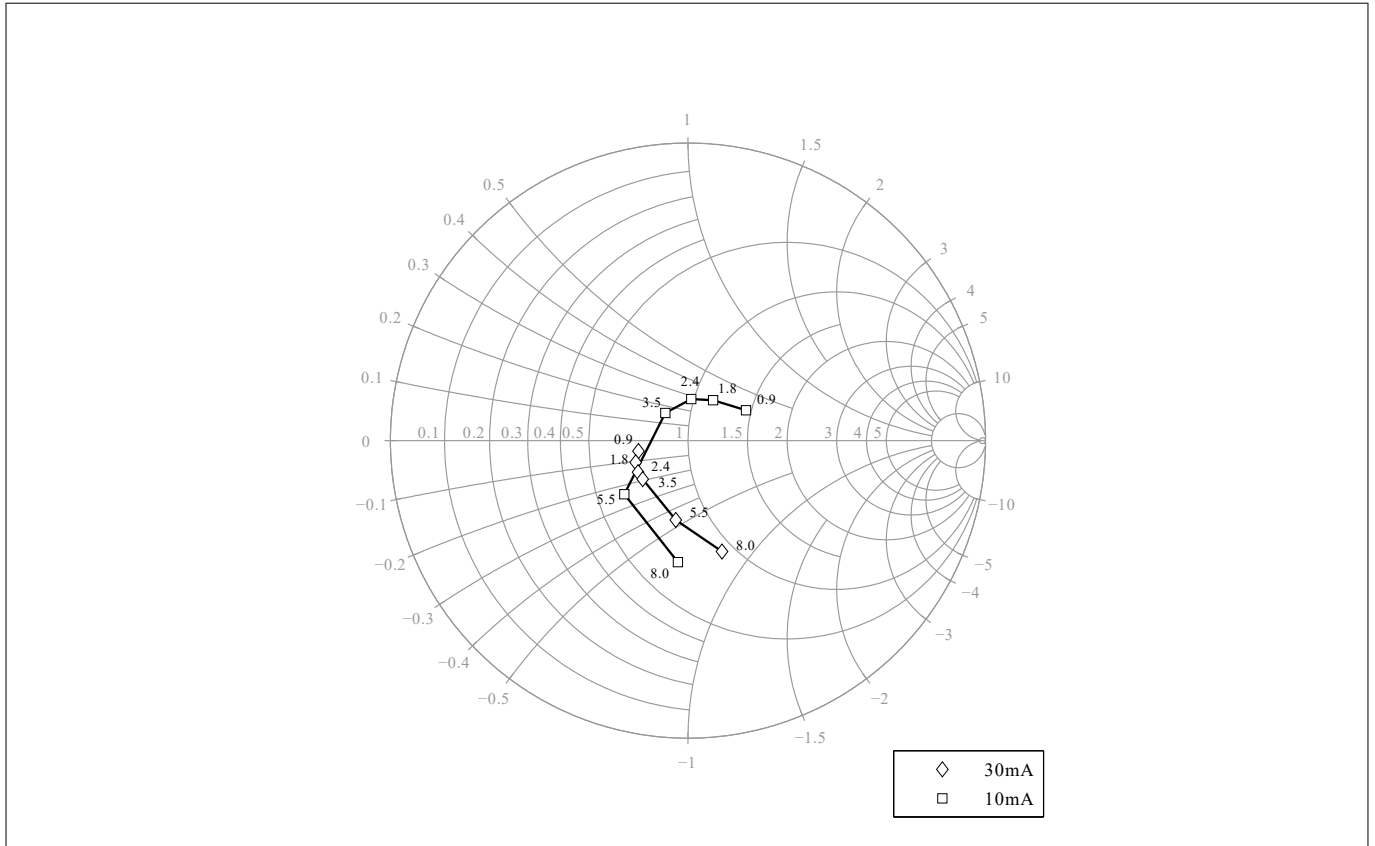

Figure 18 Source impedance for minimum noise figure $Z_{S,opt} = f(f)$, $V_{CE} = 3\text{ V}$, $I_C = 10 / 30\text{ mA}$

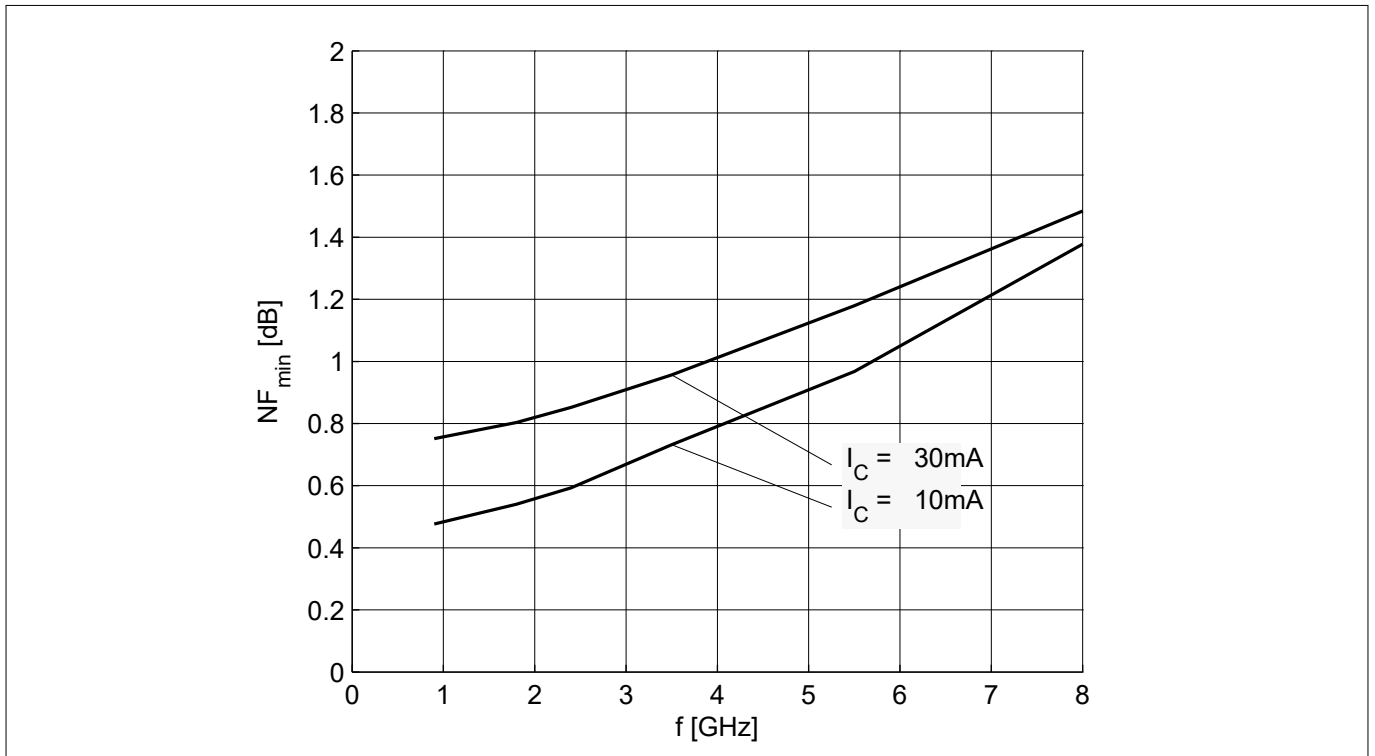

Figure 19 Noise figure $NF_{min} = f(f)$, $V_{CE} = 3\text{ V}$, $Z_S = Z_{S,opt}$, $I_C = 10 / 30\text{ mA}$

Electrical characteristics

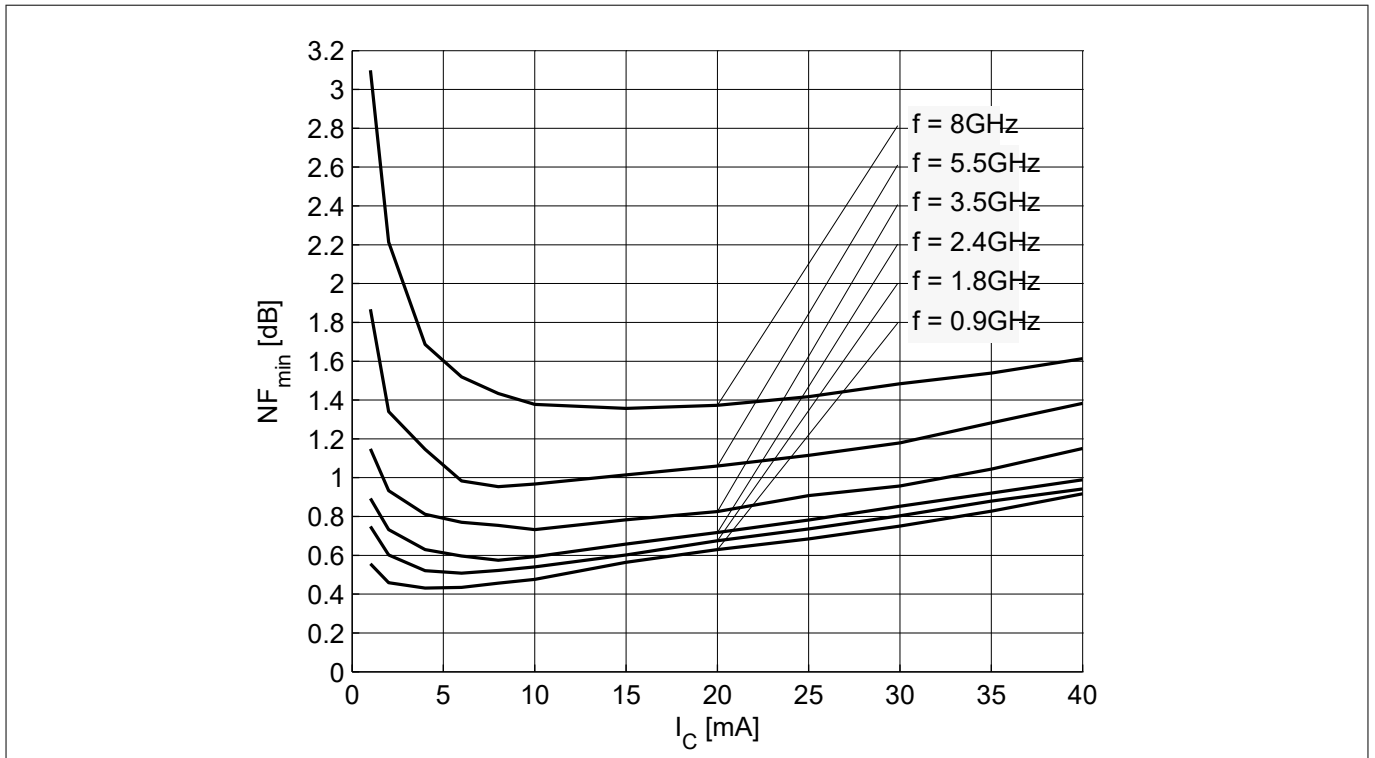

Figure 20 Noise figure $NF_{min} = f(I_C)$, $V_{CE} = 3\text{ V}$, $Z_S = Z_{S,opt}$, $f =$ parameter in GHz

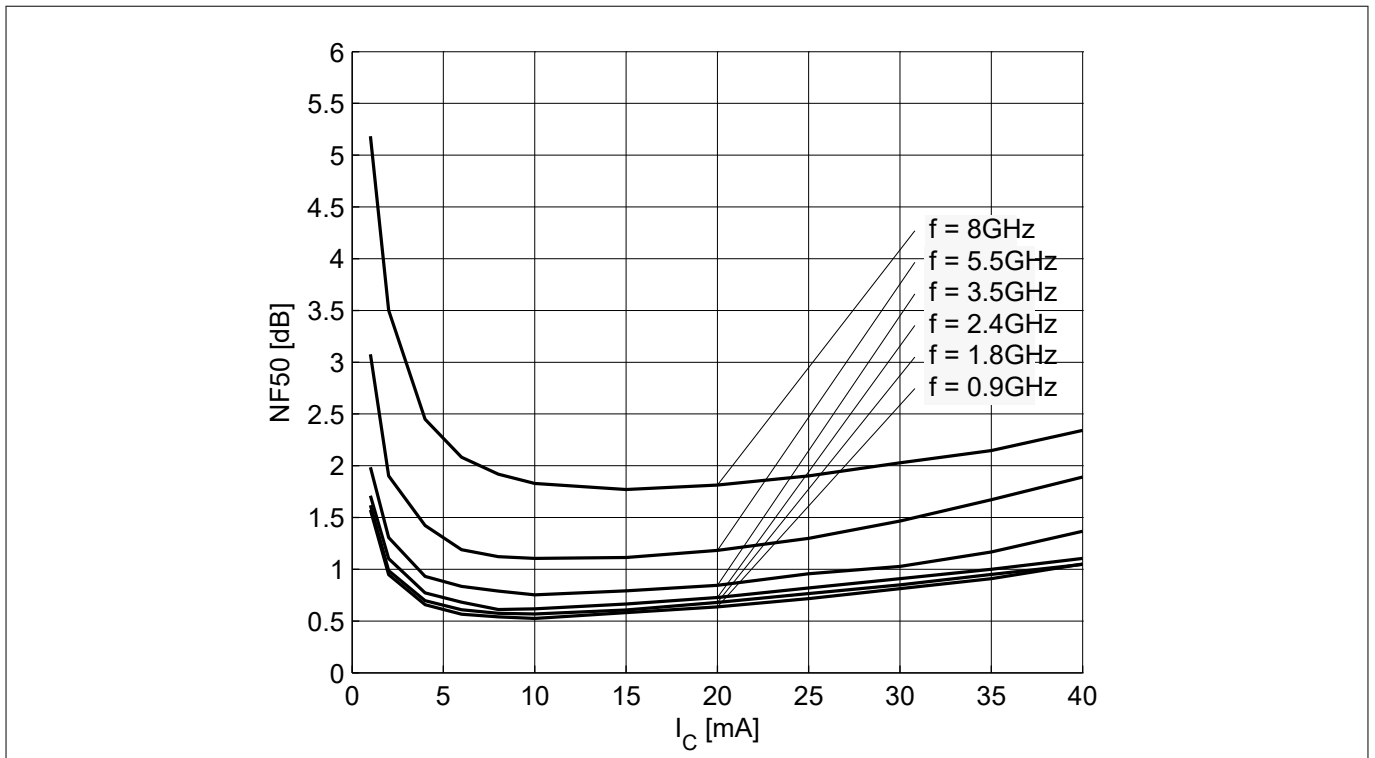

Figure 21 Noise figure $NF_{50} = f(I_C)$, $V_{CE} = 3\text{ V}$, $Z_S = 50\ \Omega$, $f =$ parameter in GHz

Note: The curves shown in this chapter have been generated using typical devices but shall not be considered as a guarantee that all devices have identical characteristic curves. $T_A = 25\text{ }^\circ\text{C}$.

4 Package information SOT343

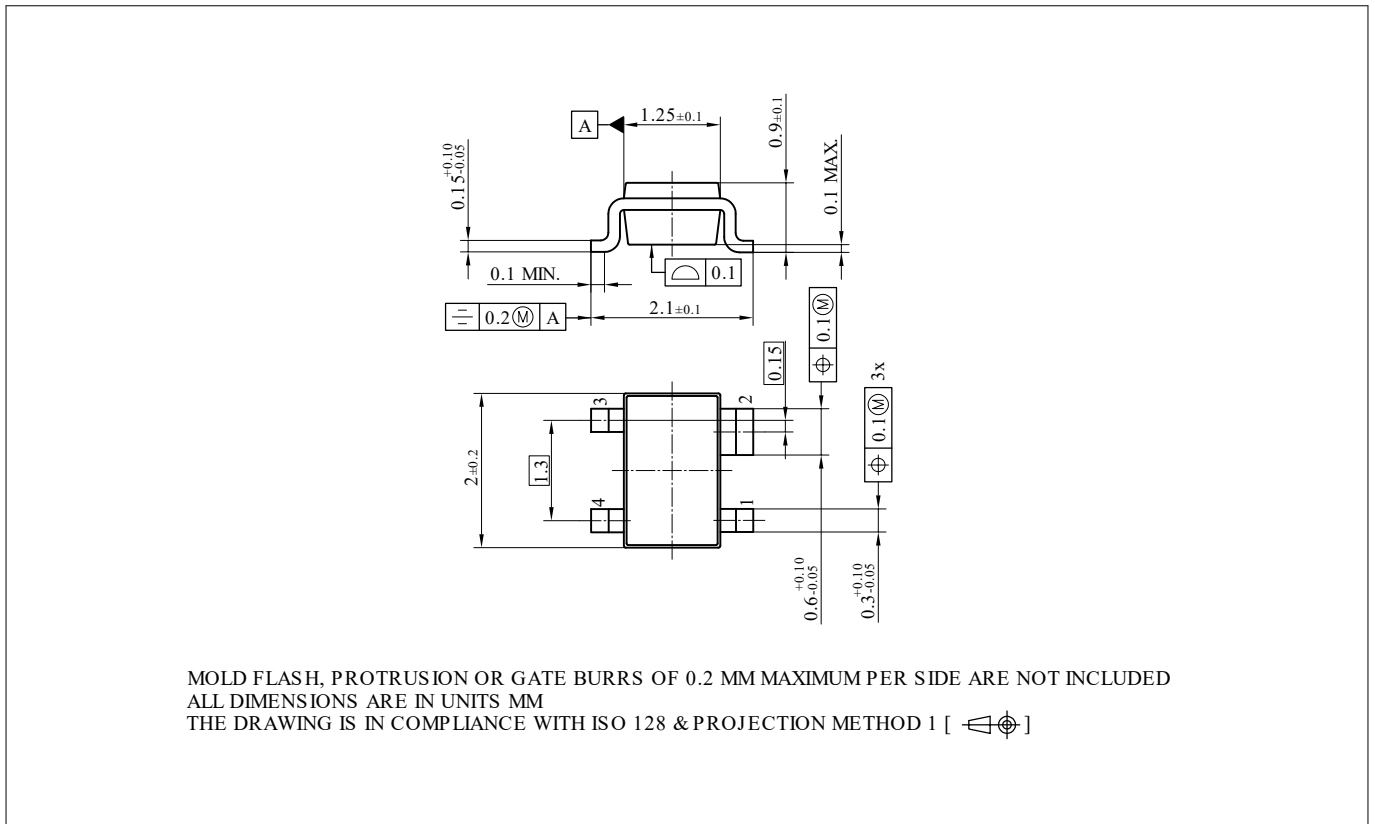

Figure 22 SOT343 package

Note: For package information including footprint, packing and assembly recommendation refer to:

<https://www.infineon.com/cms/en/product/packages/PG-SOT343/PG-SOT343-4-1>

Revision history

Revision history

Document version	Date of release	Description of changes
Revision 2.0	2018-09-26	New datasheet layout.
Revision 3.0	2024-07-01	Updated product validation

Trademarks

All referenced product or service names and trademarks are the property of their respective owners.

Edition 2024-07-01

Published by

Infineon Technologies AG

81726 Munich, Germany

© 2024 Infineon Technologies AG

All Rights Reserved.

Do you have a question about any aspect of this document?

Email: erratum@infineon.com

Document reference

IFX-leh1519206637391

Important notice

The information given in this document shall in no event be regarded as a guarantee of conditions or characteristics ("Beschaffheitsgarantie").

With respect to any examples, hints or any typical values stated herein and/or any information regarding the application of the product, Infineon Technologies hereby disclaims any and all warranties and liabilities of any kind, including without limitation warranties of non-infringement of intellectual property rights of any third party.

In addition, any information given in this document is subject to customer's compliance with its obligations stated in this document and any applicable legal requirements, norms and standards concerning customer's products and any use of the product of Infineon Technologies in customer's applications.

The data contained in this document is exclusively intended for technically trained staff. It is the responsibility of customer's technical departments to evaluate the suitability of the product for the intended application and the completeness of the product information given in this document with respect to such application.

Warnings

Due to technical requirements products may contain dangerous substances. For information on the types in question please contact your nearest Infineon Technologies office.

Except as otherwise explicitly approved by Infineon Technologies in a written document signed by authorized representatives of Infineon Technologies, Infineon Technologies' products may not be used in any applications where a failure of the product or any consequences of the use thereof can reasonably be expected to result in personal injury.