

# How to implement an image sensor interface using EZ-USB™ FX3 in a USB Video Class (UVC) framework

## About this document

### Scope and purpose

The high bandwidth provided by USB 3.0 puts high demands on ICs that connect peripherals to USB. This application note focuses on a popular USB 3.0 application: a camera (image sensor interfaced with EZ-USB™ FX3) streaming uncompressed data into a PC. The application note highlights the EZ-USB™ FX3 features specifically designed to maximize data throughput without sacrificing interface flexibility. This application note also gives implementation details about the USB Video Class (UVC). Conforming to this class allows the camera device to operate using built-in PC drivers and host applications, such as AMCap, Webcamoid, MPC-HC, and VLC media player. Finally, the application note shows you how to use the flexible image sensor interface in EZ-USB™ FX3 to connect two image sensors to implement 3D imaging and motion-tracking applications.

### Intended audience

This document is primarily intended for anyone need to implement an image sensor interface using EZ-USB™ FX3 in a USB Video Class (UVC) framework.

### Associated part family

[CYUSB301x](#), [CYUSB201x](#)

### More code examples? We heard you.

To access an ever-growing list of USB SuperSpeed, please visit our [code examples web page](#).

## Table of contents

<b>About this document</b> .....	<b>1</b>
<b>Table of contents</b> .....	<b>1</b>
<b>1 Introduction</b> .....	<b>4</b>
1.1 More information.....	5
<b>2 USB Video Class (UVC)</b> .....	<b>7</b>
2.1 Enumeration data .....	7
2.2 Operational code.....	7
2.3 USB video class requirements .....	8
2.3.1 USB descriptors for UVC.....	8
2.3.1.1 Video control interface .....	9
2.3.1.2 Video streaming interface.....	9
2.3.2 UVC-specific requests .....	10
2.3.2.1 Control requests – Brightness, PTZ control and extension unit control.....	14
2.3.2.2 Streaming requests – Probe and commit control .....	15
2.3.3 Video data format: YUY2 .....	16
2.3.4 UVC video data header.....	16

# How to implement an image sensor interface using EZ-USB™ FX3 in a USB Video Class (UVC) framework



## Table of contents

2.3.5	Still image capture .....	18
2.3.5.1	Method 2 still image capture .....	18
<b>3</b>	<b>GPIF II image sensor interface.....</b>	<b>20</b>
3.1	Image sensor interface.....	20
3.1.1	GPIF II interface requirements.....	20
3.2	Pin mapping of image sensor interface.....	21
3.3	Ping-pong DMA buffers .....	22
3.4	Design strategy.....	23
3.5	GPIF II state machine.....	24
3.6	Implementing image sensor interface using GPIF II designer .....	27
3.6.1	Create the project .....	27
3.6.2	Define the interface.....	29
3.6.3	Draw the state machine .....	33
3.6.4	Draw the GPIF II state machine.....	33
3.6.5	Editing GPIF II interface details .....	41
<b>4</b>	<b>Setting up the DMA system .....</b>	<b>43</b>
4.1	About DMA buffers.....	47
<b>5</b>	<b>EZ-USB™ FX3 firmware.....</b>	<b>49</b>
5.1	Application thread.....	51
5.2	Initialization.....	52
5.3	Enumeration.....	52
5.4	Configuring the image sensor through the I <sup>2</sup> C interface .....	52
5.5	Starting the video streaming .....	52
5.6	Setting up DMA buffers.....	53
5.7	Handling the DMA buffers during video streaming.....	53
5.8	Terminating the video streaming .....	53
5.9	Adding a “debug” interface.....	54
5.9.1	Debug interface details.....	54
5.9.2	Using the debug interface.....	58
5.9.2.1	Single read.....	58
5.9.2.2	Sequential read .....	61
5.9.2.3	Single write.....	62
5.9.2.4	Sequential write .....	63
<b>6</b>	<b>Hardware setup .....</b>	<b>64</b>
6.1	Hardware requirement .....	64
6.2	SuperSpeed explorer kit board setup .....	64
<b>7</b>	<b>UVC-based host applications .....</b>	<b>67</b>
7.1	Running the demo.....	67
<b>8</b>	<b>Troubleshooting .....</b>	<b>70</b>
8.1	Black screen or incorrect color visible in the host application.....	70
8.2	Reduced frames per second observed in the host application .....	70
<b>9</b>	<b>Connecting two image sensors .....</b>	<b>72</b>
9.1	Transferring the interleaved image over UVC .....	73
9.1.1	Example 1: Two 640 x 480 monochrome sensors .....	73
9.1.2	Example 2: Two 640 x 480 color sensors .....	74
9.2	Firmware modification checklist to add new video format to the current project .....	74
9.3	Firmware modification checklist to add new video resolution to the current project.....	75
9.4	Checklist for firmware modification to support a new sensor .....	75
<b>10</b>	<b>Summary .....</b>	<b>76</b>

# How to implement an image sensor interface using EZ-USB™ FX3 in a USB Video Class (UVC) framework

---



## Table of contents

<b>11</b>	<b>Appendix A: Hardware setup details for EZ-USB™ FX3 DVK (CYUSB3KIT-001)</b> .....	<b>77</b>
11.1	EZ-USB™ FX3 DVK board setup .....	77
<b>12</b>	<b>Appendix B: Hardware setup details for EZ-USB™ FX3 explorer kit and Aptina image sensor interconnect board (CYUSB3ACC-004)</b> .....	<b>80</b>
12.1	Hardware setup .....	80
	<b>References</b> .....	<b>82</b>
	<b>Revision history</b> .....	<b>83</b>

## Introduction

### 1 Introduction

The high bandwidth provided by USB 3.0 puts high demands on ICs that connect peripherals to USB. A popular example is a camera streaming uncompressed data into a PC. In this application note, a converter that connects to the image sensor on one side and to a USB 3.0 host PC on the other side is implemented using the Infineon EZ-USB™ FX3 chip. EZ-USB™ FX3 uses its General Programmable Interface, Gen 2 (GPIF II), to provide the image sensor interface, and its SuperSpeed USB unit to connect to the PC. The EZ-USB™ FX3 firmware converts the data coming from the image sensor into a format compatible with the UVC. Conforming to this class allows the camera to operate using built-in OS drivers, making the camera compatible with host applications, such as AMCap, MPC-HC, Webcamoid, and VLC media player.

The steps specified in this application note are applicable to EZ-USB™ FX2G2, the USB 2.0 part from the EZ-USB™ FX3 family, as well.

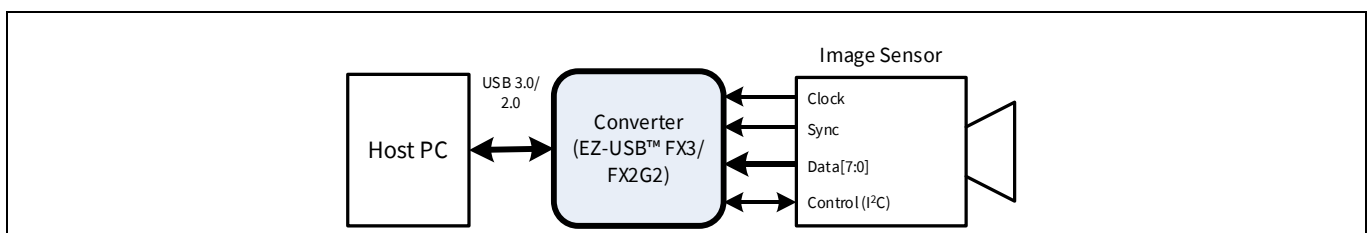

**Figure 1** Camera application

*Note:* For information on interfacing MIPI CSI-2 image sensor with EZ-USB™ CX3, refer to [AN90369](#).

**Figure 1** illustrates the camera application. On the left side is a PC equipped with a SuperSpeed USB 3.0 port. On the right side is an image sensor with the following features:

- 8-bit synchronous parallel data interface
- 16 bits per pixel
- YUY2 color space
- 1280 x 720-pixel resolution (720p)
- 30 frames per second
- Active high frame/line valid signals
- Positive clock edge polarity

Although this application note discusses a specific image sensor interface, these features are common to many image sensor interfaces with slight variations, such as data bus width and signal polarities. As a result of the programmable nature of the GPIF II block, these variations can easily be accommodated. In addition, EZ-USB™ FX3 uses its I<sup>2</sup>C interface to implement a control bus for image sensor configuration.

**Figure 2** is a more detailed system block diagram. The main sub-blocks of the block diagram are numbered, and the tasks that are executed by each sub-block are described below:

# How to implement an image sensor interface using EZ-USB™ FX3 in a USB Video Class (UVC) framework



## Introduction

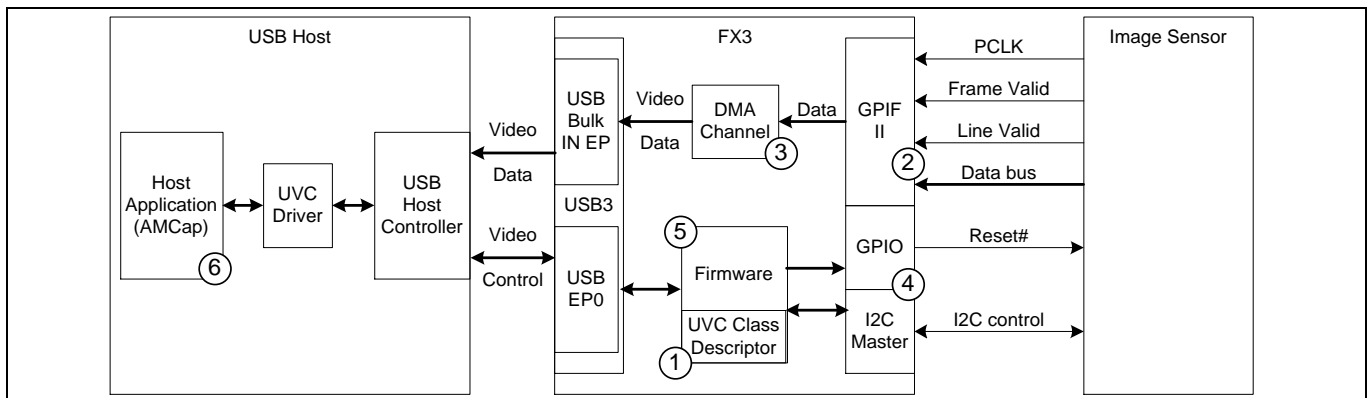

**Figure 2** System block diagram

1. Provide the proper USB descriptors so that the host recognizes the peripheral as a device conforming to the UVC. For details, refer to [Section 2](#).
2. Implement a parallel-bus interface to the image sensor. This is done using the EZ-USB™ FX3 GPIF II interface. A Infineon tool called [GPIF II designer](#) allows custom waveforms to be designed in a graphical state machine editor. Because the interface is programmable, minor edits can customize it for a different image sensor, for example one with a 16-bit data bus. For details, refer to [Section 3](#).
3. Construct a DMA channel that moves the image sensor data from the GPIF II block to the USB Interface Block (UIB). In this application, header data must be added to the image sensor's video data to conform to the UVC specification. As such, the DMA is configured to enable the CPU to add the required header to the DMA buffers. This channel must be designed so that maximum bandwidth can be used to stream video from the image sensor to the PC. For details, refer to [Section 4](#).
4. Use the EZ-USB™ FX3 I<sup>2</sup>C master to implement a control bus to the image sensor. The I<sup>2</sup>C and GPIO units are programmed using standard Infineon library calls, and they are mentioned in [Section 5.4](#).
5. The EZ-USB™ FX3 firmware initializes the hardware blocks of EZ-USB™ FX3 ([Section 5.2](#)), enumerates as a UVC camera ([Section 2.3.1](#)), handles UVC-specific requests ([Section 2.3.2](#)), translates video control settings (such as brightness) to the image sensor over the I<sup>2</sup>C interface ([Section 5.4](#)), adds a UVC header to the video data stream ([Section 2.3.4](#)), commits the video data with headers to USB ([Section 5.7](#)), and maintains the GPIF II state machine ([Section 5.8](#)).
6. A host application, such as the AMCap, MPC-HC, Webcamoid or VLC media player, accesses the UVC driver to configure the image sensor over the UVC control interface and to receive video data over the UVC streaming interface. For details on UVC-based host applications, refer to [Section 7](#).

If the camera is plugged into a USB 2.0 port, the EZ-USB™ FX3 firmware uses the I<sup>2</sup>C control bus to reduce the frame rate from 30 FPS to 15 FPS and the frame size from 1280 x 720 pixels to 640 x 480 pixels to accommodate the lower USB bandwidth. The maximum UVC throughput in bytes (frame height × frame width × pixel size × frames per second) should be less than 40-MBps. Note that the observed frames per second will be dependent on the frame blanking and the line blanking times of the image sensor.

The PC host optionally can use the control interface to send brightness, pan, tilt, and zoom adjustments to the camera. Pan, tilt, and zoom are usually implemented together and are referred to as PTZ.

## 1.1 More information

Infineon provides a wealth of data at [www.cypress.com](http://www.cypress.com) to help you to select the right device for your design, and to help you to integrate the device into your design quickly and effectively.

- Overview: [USB portfolio](#), [USB roadmap](#)

# How to implement an image sensor interface using EZ-USB™ FX3 in a USB Video Class (UVC) framework



## Introduction

- USB 3.0 product selectors: [EZ-USB™ FX3](#), [EZ-USB™ FX3S](#), [EZ-USB™ CX3](#), [EZ-USB™ HX3](#), [EZ-USB™ SX3](#)
- Application notes: Infineon offers a large number of USB application notes covering a broad range of topics, from basic to advanced level. Recommended application notes for getting started with EZ-USB™ FX3 are:
  - [AN75705](#) – Getting started with EZ-USB™ FX3
  - [AN231295](#) – Getting started with EZ-USB™ SX3
  - [AN70707](#) – EZ-USB™ FX3/FX3S hardware design guidelines and schematic checklist
  - [AN65974](#) – Designing with the EZ-USB™ FX3 slave FIFO interface
  - [AN75779](#) – How to implement an image sensor interface with EZ-USB™ FX3 in a USB Video Class (UVC) framework
  - [AN86947](#) – Optimizing USB 3.0 throughput with EZ-USB™ FX3
  - [AN84868](#) – Configuring an FPGA over USB using EZ-USB™ FX3
  - [AN68829](#) – Slave FIFO interface for EZ-USB™ FX3: 5-bit address mode
  - [AN76348](#) – Differences in implementation of EZ-USB™ FX2LP and EZ-USB™ FX3 applications
  - [AN89661](#) – USB RAID 1 disk design using EZ-USB™ FX3S
- Code examples:
  - [USB Hi-Speed](#)
  - [USB Full-Speed](#)
  - [USB SuperSpeed](#)
- Knowledge base articles (KBA)
  - [UVC troubleshooting guide – KBA226722](#)
  - [Change bulk endpoint to isochronous in FX3 firmware – KBA231897](#)
  - [Invalid sequence error in multi-channel commit buffer - KBA218830](#)
  - [Handling commit buffer failures occurred during video transfers using EZ-USB™ FX3 – KBA231382](#)
  - [Modified AN75779 firmware for streaming video using cyusb3.sys driver – KBA233542](#)
  - [FX3/CX3: UVC extension unit application – KBA230466](#)
  - [Implementing extension unit control in AN75779 example project - KBA219280](#)
- Technical reference manual (TRM):
  - [EZ-USB™ FX3 technical reference manual](#)
- Development kits:
  - [CYUSB3KIT-003, EZ-USB™ FX3 SuperSpeed explorer kit](#)
- Models: [IBIS](#)

## USB Video Class (UVC)

## 2 USB Video Class (UVC)

Conforming to the UVC requires two EZ-USB™ FX3 code modules:

- Enumeration data
- Operational code

### 2.1 Enumeration data

The code attached to this application note includes a file, named `cyfxuvcdscr.c` (explained in [section 2.3.1](#)), that contains the UVC enumeration data. The USB specification, which defines the format for UVC descriptors, is available in the video class section at [usb.org](http://usb.org). This section gives a high-level view of the descriptors. A UVC device has four logical elements:

1. Input camera terminal (IT)
2. Output terminal (OT)
3. Processing unit (PU)
4. Extension unit (EU)

The elements connect in the descriptors, as shown in [Figure 3](#). Connections are made between elements by associating terminal numbers in the descriptors. For example, the Input (camera) terminal descriptor declares its ID to be 1, and the processing unit descriptor specifies its input connection to have the ID of 1, logically connecting it to the input terminal. The output terminal descriptor specifies which USB endpoint to use, in this case BULK-IN endpoint 3.

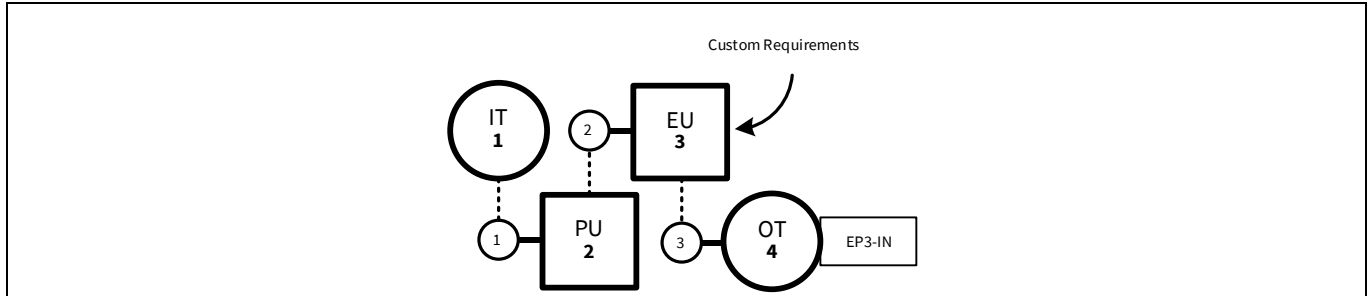

**Figure 3** UVC diagram of the camera architecture

The descriptors also include video properties, such as width, height, frame rate, frame size, and bit depth, and control properties, such as brightness, exposure, gain, contrast, and PTZ. Apart from the standard video controls, extension unit provides additional controls based on user requirements.

*Note:* The maximum bandwidth achievable using the ISOC-IN endpoint under UVC for USB 3.0 in Windows 7/8 machine is 24 Mbps because the UVC driver limits the BURST to 1 for the ISOC endpoint. But with the Windows 10 machine, BURST can be set to 15 to achieve maximum ISOC bandwidth. There is no such limitation for BULK endpoint. Therefore, the ISOC-IN endpoint is not used in this project. Refer to this [forum post](#) for more information.

### 2.2 Operational code

After the host enumerates the camera, the UVC driver sends a series of requests to the camera to determine operational characteristics. This is called the capability request phase. It precedes the streaming phase, in which the host application starts streaming video. The EZ-USB™ FX3 firmware responds to the requests that arrive over the USB control endpoint (EP0).

# How to implement an image sensor interface using EZ-USB™ FX3 in a USB Video Class (UVC) framework



## USB Video Class (UVC)

For example, suppose a UVC device indicates that it supports a brightness control in one of its USB descriptors. During the capability request phase, the UVC driver queries the device to discover the relevant brightness parameters.

When a host application makes a request to change the brightness value, the UVC driver issues a SET control request to change the brightness value (SET\_CUR).

Similarly, when the host application chooses to stream a supported video format/frame rate/frame size, it issues streaming requests. There are two types: PROBE and COMMIT. PROBE requests are used to determine if the UVC device is ready to accept changes to the streaming mode. A streaming mode is a combination of image format, frame size, and frame rate.

## 2.3 USB video class requirements

The firmware project for this application note is in the folder named **cyfxuvc\_an75779**. This section explains how the UVC requirements are satisfied by the example project. The UVC requires a device to:

- Enumerate with the UVC-specific USB descriptors
- Handle SET/GET UVC-specific requests for the UVC control and stream capabilities reported in the USB descriptors
- Stream video data in a UVC-conformant color format
- Add a UVC conformant header for every image payload

Details of these requirements are found in the [UVC specification](#).

### 2.3.1 USB descriptors for UVC

The **cyfxuvcdscr.c** file contains the USB descriptor tables. The byte arrays “CyFxUSBHSCfgDscr” (Hi-Speed) and “CyFxUSBSSCfgDscr” (SuperSpeed) contain the UVC-specific descriptors. These descriptors implement the following tree of sub-descriptors:

#### Configuration descriptor

- Interface association descriptor
- Video control (VC) interface descriptor
  - VC interface header descriptor
    - Input (camera) terminal descriptor
    - Processing unit descriptor
    - Extension unit descriptor
    - Output terminal descriptor
  - VC status interrupt endpoint descriptor
- Video streaming (VS) interface descriptor
  - VS interface input header descriptor
    - VS format descriptor
    - VS frame descriptor
- BULK-IN video endpoint descriptor

The configuration descriptor is a standard USB descriptor that defines the functionality of the USB device in its sub-descriptors. The interface association descriptor is used to indicate to the host that the device conforms to a standard USB class. Here, this descriptor reports a UVC-conformant device with two interfaces: video control



## USB Video Class (UVC)

(VC) interface and video streaming (VS) Interface. Having two separate interfaces makes the UVC device a USB composite device.

### 2.3.1.1 Video control interface

The VC Interface descriptor and its sub-descriptors report all of the control interface-related capabilities. Examples include brightness, contrast, hue, exposure, and PTZ controls.

The VC interface header descriptor is a UVC-specific interface descriptor that points to the VS interfaces to which this VC Interface belongs.

The input (camera) terminal descriptor, the processing unit descriptor, the extension unit descriptor, and the output terminal descriptor contain bit fields that describe features supported by the respective terminal or unit.

The camera terminal controls mechanical (or equivalent digital) features, such as exposure and the PTZ of the device that transmits the video stream.

The processing unit controls image attributes, such as brightness, contrast, and hue of the video being streamed through it.

The extension unit allows vendor-specific features to be added, much like standard USB vendor requests. In this design, the extension unit is empty but a sample design is implemented and it can be enabled to get or set the device firmware version. If the extension unit is utilized, the standard host application will not see its features unless the host application is designed to recognize them. A sample host application is provided to get or set the device firmware version. You can design your own extension controls and host application to query these controls. Some features that can be supported include getting the device firmware version and hardware IDs, writing to sensor/image signal processor (ISP) registers, and so on. The device can support more than one extension unit. For more details on UVC extension unit with the associated firmware project, see [Section 2.3.2](#).

The output terminal is used to describe an interface between these units (IT, PU, EU) and the host. The VC status interrupt endpoint descriptor is a standard USB descriptor for an Interrupt endpoint. This endpoint can be used to communicate UVC-specific status information. The functionality of this endpoint is outside the scope of this application note.

The UVC specification divides these functionalities so that you can easily structure the implementation of the class-specific control requests. However, the implementation of these functionalities is application-specific. The supported control capabilities are reported in the bit field “bmControls” (**cyfxuvcdscr.c**) of the respective terminal/unit descriptor by setting corresponding capability bits to ‘1’. The UVC device driver polls for details about the control on enumeration. The polling for details is carried out over EPO requests. All such requests, including the video streaming requests, are handled by the **UVCAppEP0Thread\_Entry** function in the *uvc.c* file.

### 2.3.1.2 Video streaming interface

The video streaming interface descriptor and its sub-descriptors report the various frame formats (e.g., uncompressed, MPEG, H.264), frame resolutions (width, height, and bit depth), and frame rates. Based on the values reported, the host application can choose to switch streaming modes by selecting supported combinations of frame formats, frame resolutions, and frame rates.

The VS interface input header descriptor specifies the number of VS format descriptors that follow.

The VS format descriptor contains the images’ aspect ratio and the color format, such as uncompressed or compressed.

# How to implement an image sensor interface using EZ-USB™ FX3 in a USB Video Class (UVC) framework



## USB Video Class (UVC)

The VS frame descriptor contains image resolution and all supported frame rates for that resolution. If the camera supports different resolutions, multiple VS frame descriptors follow the VS format descriptor.

The BULK-IN video endpoint descriptor is a standard USB endpoint descriptor that contains information about the bulk endpoint used for streaming video.

This example uses a single resolution and frame rate. Its image characteristics are contained in three descriptors, as shown in the following three tables (only relevant byte offsets are shown).

**Table 1 VS format descriptor values**

VS format DescriptorByte offset	Characteristic	SuperSpeed value	Hi-Speed value
23-24	Width to height ratio	16:9	4:3

**Table 2 VS frame descriptor values**

VS frame DescriptorByte offset	Characteristic	SuperSpeed value	Hi-Speed value
5-8	Resolution (W, H)	1280x720	640x480
17-20	Maximum image size in bytes	1280x720x2 (2 bytes/pixel)	640x480x2 (2 bytes/pixel)
21-24, also 26-29	Frame Interval in 100 ns units	0x51615(30 FPS)	0xA2C2A(15 FPS)

Note that multiple-byte values are listed LSB first (little-endian), so, for example, the frame rate is 0x00051615, which is 33.33 milliseconds, or 30 FPS.

**Table 3 Probe/commit structure values**

Probe/ commit Structure Byte offset	Characteristic	SuperSpeed value	Hi-Speed value
2	Format index	1	1
3	Frame index	1	1
4-7	Frame interval in 100 ns units	0x51615 (30 FPS)	0xA2C2A (15 FPS)
18-21	Maximum image size in bytes	1280x720x2 (2 bytes/pixel)	640x480x2 (2 bytes/pixel)

This design can be adapted to support different image resolutions, such as 1080p, by modifying the entries in these three tables.

### 2.3.2 UVC-specific requests

The UVC specification uses USB control endpoint EP0 to communicate control and streaming requests to the UVC device. These requests are used to discover and change the attributes of the video-related controls. The UVC specification defines these video-related controls as capabilities. These capabilities allow you to change image properties or to stream video. A capability (first item) can be a video control property, such as brightness, contrast, and hue, or video stream mode properties, such as the color format, frame size, and frame rate. Capabilities are reported via the UVC-specific section of the USB Configuration descriptor. Each of the capabilities has attributes. The attributes of a capability are as follows:

- The minimum value

# How to implement an image sensor interface using EZ-USB™ FX3 in a USB Video Class (UVC) framework



## USB Video Class (UVC)

- The maximum value
- The number of values between the minimum and the maximum
- The default value
- The current value

SET and GET are the two types of UVC-specific requests. SET is used to change the current value of an attribute, while GET is used to read an attribute.

Here is a list of UVC-specific requests:

- SET\_CUR is the only type of SET request
- GET\_CUR reads the current value
- GET\_MIN reads the minimum supported value
- GET\_MAX reads the maximum supported value
- GET\_RES reads the resolution (step value to indicate the supported values between min and max)
- GET\_DEF reads the default value (return the appropriate value to set defaults for any parameter, e.g., default frame resolution, etc.)
- GET\_LEN reads the size of the attribute in bytes
- GET\_INFO queries the status/support for specific capability.

The UVC specification defines these requests as either mandatory or optional for a given capability. For example, if the SET\_CUR request is optional for a particular capability, its presence is determined through the GET\_INFO request. If the camera does not support a certain request for a capability, it must indicate this by stalling the control endpoint when the request is issued from the host to the camera.

There are byte fields in these requests that qualify their target capability. These byte fields have a hierarchy, which follows the same structure as the UVC-specific descriptors described in [Section 2.3.1](#). The first level identifies the interface (video control or video streaming).

If the first level identifies the interface as video control, the second level identifies the terminal or unit, and the third level identifies the capability of that terminal or unit. For example, if the target capability is the brightness control, then:

- First level = video control
- Second level = processing unit
- Third level = brightness control

If the first level identifies the interface as video streaming, the second level would be PROBE or COMMIT. There is no third level. When the host wants the UVC device to start streaming or to change the streaming mode, the host first determines if the device supports the new streaming mode. To determine this, the host sends a series of SET and GET requests with the second level set to PROBE. The device either accepts or rejects the change to the streaming mode. If the device accepts the change request, the host confirms it by sending the SET\_CUR request with the second level set to COMMIT. This interaction between the host and the device is illustrated in [Figure 6](#). The following three flowcharts show how the host interacts with a UVC device.

# How to implement an image sensor interface using EZ-USB™ FX3 in a USB Video Class (UVC) framework



## USB Video Class (UVC)

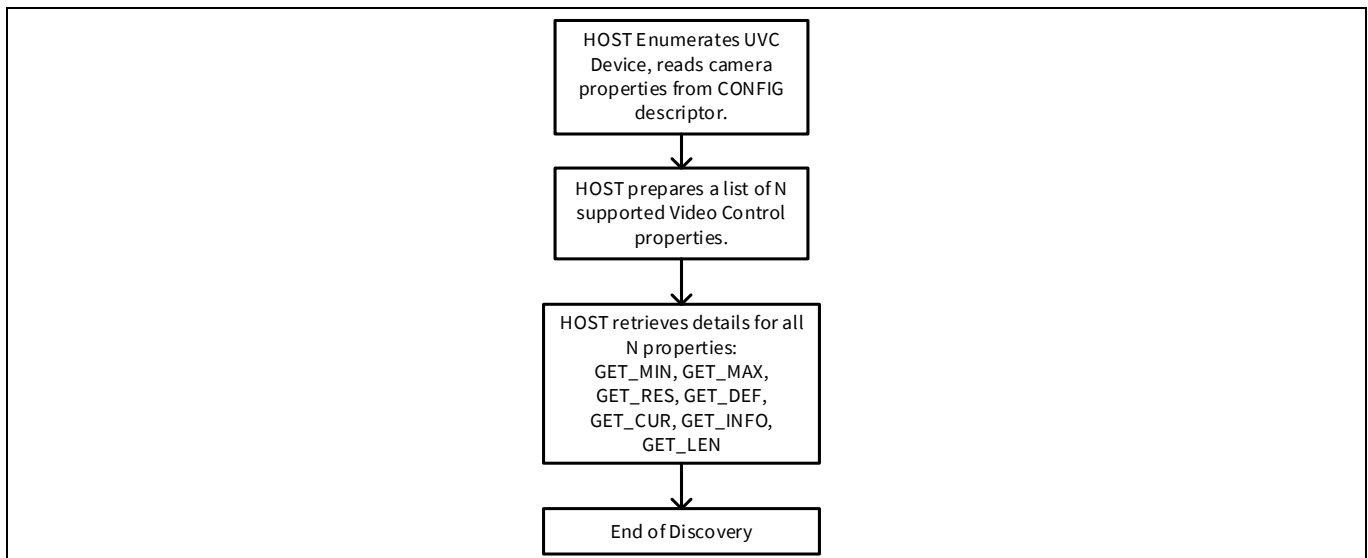

**Figure 4** The UVC enumeration and discovery flow

When the UVC device is plugged into USB, the host enumerates it and discovers details about the properties supported by the camera (Figure 4).

During a video operation, a camera operator may change a camera property, such as brightness, in a display dialog presented by the host application. Figure 5 shows this interaction.

This kind of implementation is a synchronous control transfer. As per the UVC specification, a device can support two kinds of control requests: synchronous control transfer and asynchronous control transfer.

Standard UVC requests like brightness, pan, tilt, and zoom requests take lesser time to complete (less than 10 ms). In this case, UVC device writes to a sensor/ISP register and doesn't wait for any acknowledgment from the sensor/ISP. When host drivers send a SET\_CUR request, the device responds within 10 ms with a success (acknowledge the request) or failure (stall the request). As per UVC specs, this request is synchronous in nature. All standard UVC video control requests can be supported through the synchronous control transfers.

Now assume that a host driver sets an exposure value. As per design implementation, the sensor/ISP responds with an acknowledgement in about 100 ms. The device always responds to the SET\_CUR request with a success for the SET\_CUR request and after receiving the acknowledgement from the sensor/ISP, the device loads the control status Interrupt endpoint with a success or failure. This kind of request is an asynchronous control request. The control status interrupt and associated DMA channel is already configured in this project (Refer CY\_FX\_EP\_CONTROL\_STATUS in **uvc.c** file). It is not used for asynchronous control transfers in this project as all the requests are synchronous in nature.

*Note: For more details on how to use the control status interrupt of the video control interface refer to section "Status Interrupt Endpoint" in the UVC specification.*

*Note: Refer to **CyFxBSendStatusToHost** function in **uvc.c** file for an example of how to use the control status interrupt endpoint for hardware-triggered still capture. For asynchronous video controls, the status interrupt endpoint response can be populated based on **Table 2-2: Status Packet Format (VideoControl Interface as the Originator)** of the UVC Specification, with appropriate Control selector value (**bSelector**) based on the queried video control.*

# How to implement an image sensor interface using EZ-USB™ FX3 in a USB Video Class (UVC) framework



## USB Video Class (UVC)

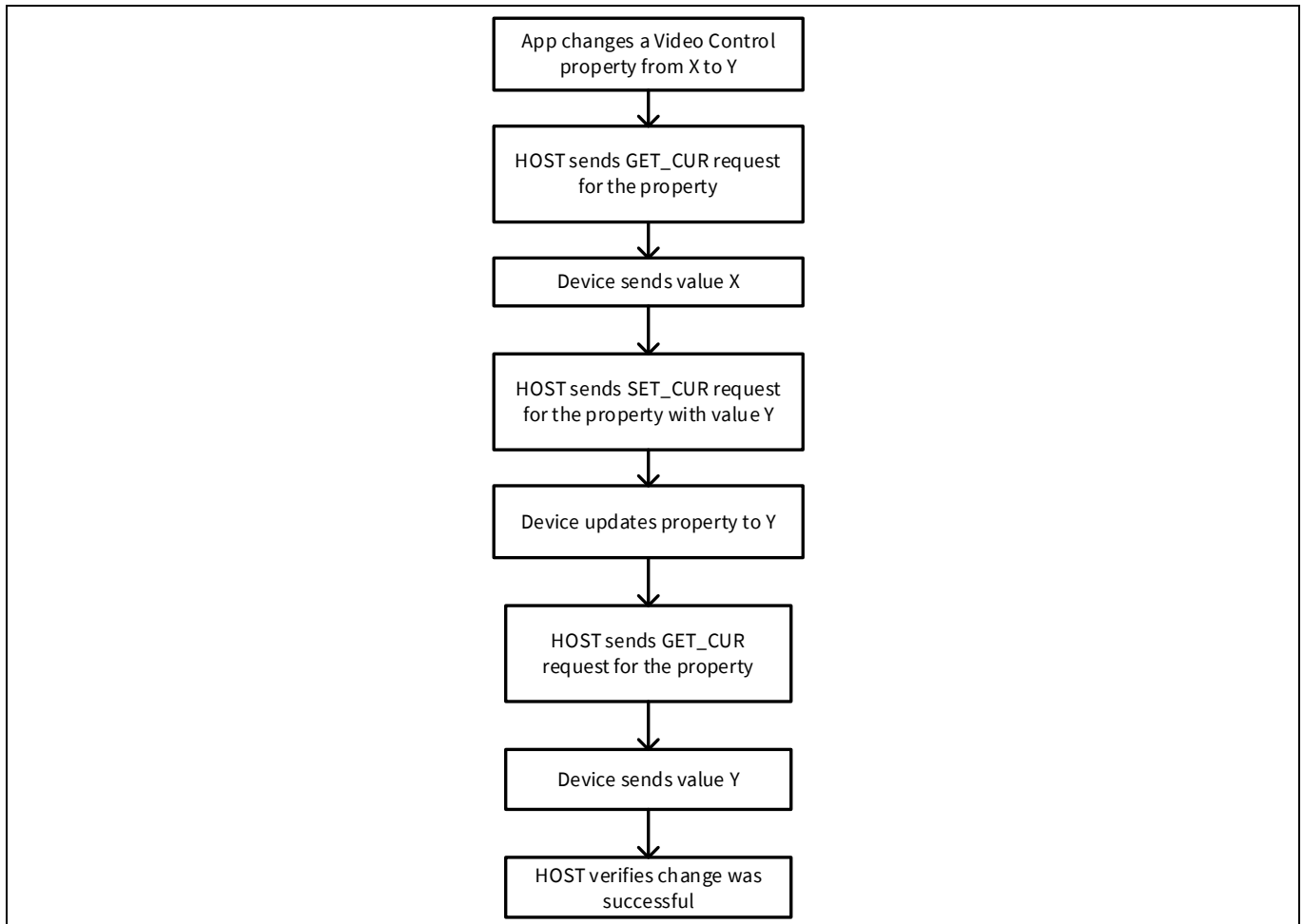

**Figure 5 A host application changes a camera setting**

Before starting to stream, the host application issues a set of probe requests to discover the possible streaming modes. After the default streaming mode is decided, the UVC driver issues a COMMIT request. This process is shown in [Figure 6](#). At this point, the UVC driver is ready to stream video from the UVC device.

## USB Video Class (UVC)

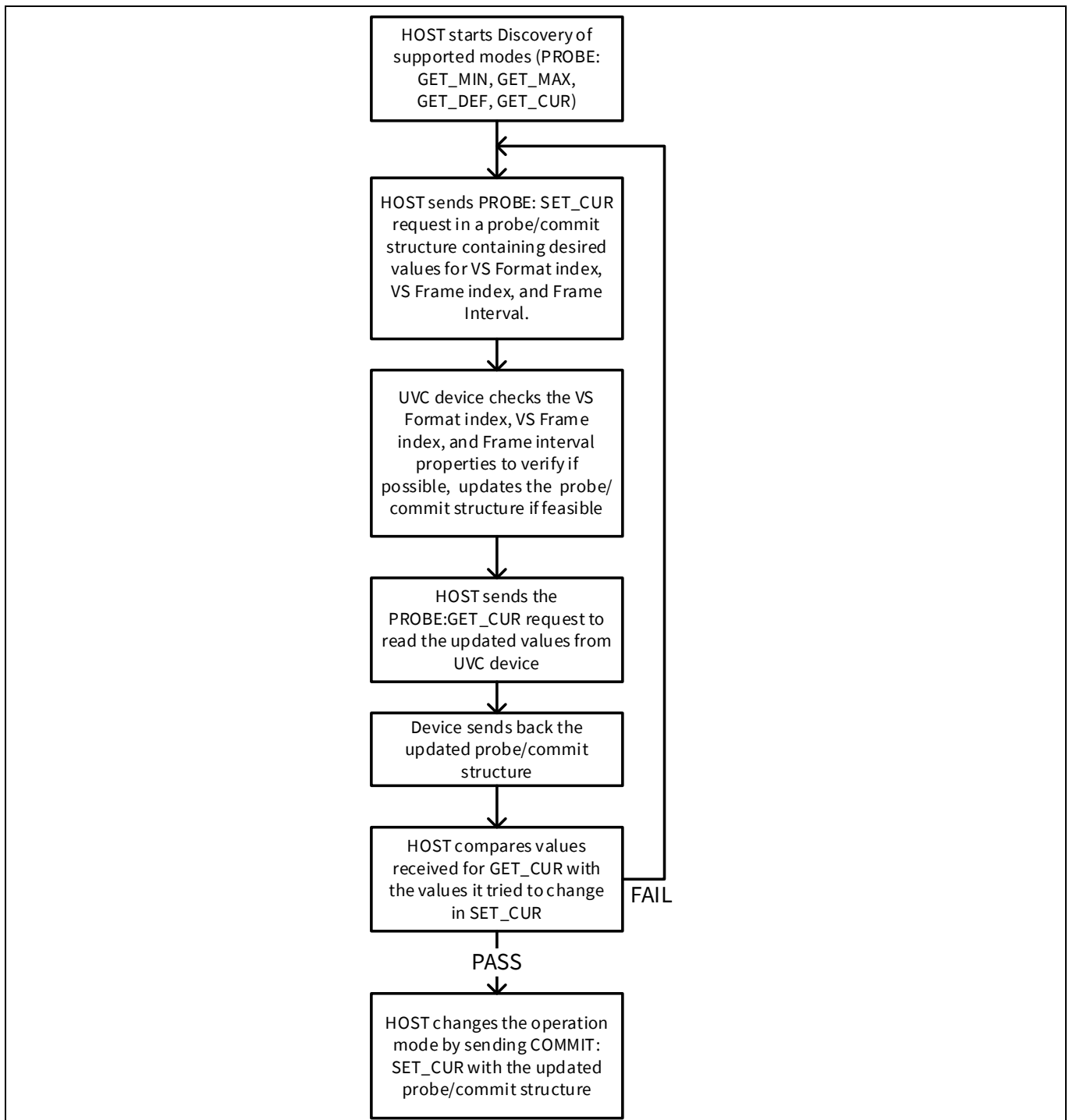

**Figure 6** Host-camera pre-streaming dialog

### 2.3.2.1 Control requests – Brightness, PTZ control and extension unit control

Brightness and PTZ controls are implemented in the associated project. PTZ can be turned on by defining “UVC\_PTZ\_SUPPORT” in the *uvc.h* file. These capabilities may or may not be supported by the image sensor. If they are not supported, specific hardware has to be designed to implement them. In any case, the firmware implementation on the USB side of the controls for these capabilities remains the same. However, the image sensor implementation would differ. Therefore, only placeholder functions are provided that implement the USB side of these controls. You have to write the code for the image sensor-specific PTZ implementation.

# How to implement an image sensor interface using EZ-USB™ FX3 in a USB Video Class (UVC) framework



## USB Video Class (UVC)

*Note: All functions described hereafter in the application note are implemented in the **uvc.c** file unless specified otherwise. This file is a part of the project stored under the **cyfxuvc\_an75779** folder in the zip of the source code attached to this application note.*

The host application sends video control requests (over EP0) that are targeted to the processing unit for brightness control. All setup requests are handled via the **CyFxUVCAppInUSBSetupCB** function. This function detects whether the host has sent a UVC-specific request (control or stream) and then sets an event flag:

“CY\_FX\_UVC\_VIDEO\_CONTROL\_REQUEST\_EVENT” or “CY\_FX\_UVC\_VIDEO\_STREAM\_REQUEST\_EVENT”, respectively. Then, the flag is processed by function **UVCAppEP0Thread\_Entry** (EP0 application thread).

Brightness control requests will trigger the video control request event flag. The EP0 application thread, which is waiting for any of these flags to trigger, decodes the video control request and calls the appropriate function. The EP0 application thread calls the **UVCHandleProcessingUnitRqts** function to handle brightness control requests.

Modify the **UVCHandleProcessingUnitRqts** function to implement processing unit-related controls (brightness, contrast, hue, and so on). Modify the **UVCHandleCameraTerminalRqts** function to implement camera terminal controls. Modify the **UVCHandleExtensionUnitRqts** function to implement any vendor-specific requests. To enable support for any of these controls, you must set corresponding bits in the USB descriptors. The UVC specification includes details on camera terminal, processing unit, and extension unit USB descriptors.

A sample extension unit control – Get or set device firmware version is implemented in the associated project. The control can be turned ON by defining “UVC\_EXTENSION\_UNIT” in the *uvc.h* file. See [KBA219280](#) for more details on how to design a UVC extension unit in the firmware. The get or set firmware version control allows you to get and set the app note firmware version. This can be done by using the *uvc\_extension\_app\_x86.exe* (for 32-bit Windows) or *uvc\_extension\_app\_x64* (for 64-bit Windows). Guidelines to run the host application is provided in the *readme.txt* file in the attached project. The host application is based on Microsoft’s Media foundation class and DirectShow APIs. For more information on the host application, see the [forum discussion](#).

### 2.3.2.2 Streaming requests – Probe and commit control

**UVCHandleVideoStreamingRqts** handles streaming-related requests. When the UVC driver needs to stream video from a UVC device, the first step is negotiation. In that phase, the driver sends PROBE requests, such as GET\_MIN, GET\_MAX, GET\_RES, and GET\_DEF. In response, the EZ-USB™ FX3 firmware returns a PROBE structure. The structure contains the USB descriptor indices of video format and video frame, frame rate, maximum frame size, and payload size (the number of bytes that the UVC driver can fetch in one transfer).

The switch case for “CY\_FX\_UVC\_PROBE\_CTRL” handles the negotiation phase of the streaming for either a USB 2.0 or USB 3.0 connection (the properties of the supported video in these modes differ). Note that the reported values for GET\_MIN, GET\_MAX, GET\_DEF, and GET\_CUR are the same because the same streaming mode is supported in either USB 2.0 or USB 3.0. These values would differ if multiple streaming modes need to be supported.

The switch case for “CY\_FX\_UVC\_COMMIT\_CTRL” handles the start of the streaming phase. The SET\_CUR request for COMMIT control indicates that the host will start streaming video next. Therefore, SET\_CUR for COMMIT control sets the “CY\_FX\_UVC\_STREAM\_EVENT” event, which indicates the main application thread **UVCAppThread\_Entry** to start the GPIF II state machine for video streaming.



## USB Video Class (UVC)

### 2.3.3 Video data format: YUY2

The UVC specification supports only a subset of color formats for video data. Therefore, you should choose an image sensor that streams images in a color format that conforms to the UVC specification. This application note covers an uncompressed color format called YUY2, which is supported by most, but not all, image sensors. The YUY2 color format is a 4:2:2 down-sampled version of the YUV color format. Luminance values Y are sampled for every pixel, but chrominance values U and V are sampled only for even pixels. This creates “macro pixels”, each of which describes two image pixels using a total of four bytes. Notice that every other byte is a Y value, and the U and V values represent only even pixels:

Y0, U0, Y1, V0 (first 2 pixels)

Y2, U2, Y3, V2 (next 2 pixels)

Y4, U4, Y5, V4 (next 2 pixels)

Refer to [Wikipedia](#) for additional information on color formats.

*Note: The RGB format is not supported in the project attached with application note. For RGB format support, refer to the example projects “cycx3\_rgb16\_as0260” and “cycx3\_rgb24\_as0260” in **FX3 SDK** (Path: <FX3 SDK installation path>\EZ-USB™ FX3 SDK\1.3\firmware\cx3\_examples).*

Although a monochrome image is not supported as a part of the UVC specification, an 8-bit monochrome image can be represented in the YUY2 format by sending the monochrome image data as Y values and setting all the U and V values to 0x80.

### 2.3.4 UVC video data header

The UVC class requires a 12-byte header for uncompressed video payloads. The header describes the properties of the image data being transferred. For example, it contains a “new frame” bit that the image sensor controller (EZ-USB™ FX3) toggles for every frame. The EZ-USB™ FX3 code also can set an error bit in the header to indicate a problem in streaming the current frame. This UVC data header is required for every USB transfer. Refer to the UVC specification for additional details. [Table 4](#) shows the format of the UVC video data header.

**Table 4 UVC video data header format**

Byte offset	Field name	Description
0	HLF	bHeaderLength - Header length field specifies the length of the header in bytes
1	BFH	bmHeaderInfo - Bit field header indicates type of the image data, status of the video stream and presence or absence of other fields
2-5	PTS	dwPresentationTime - Presentation time stamp indicates the source clock time in native device clock units
6-11	SCR	scrSourceClock - Source clock reference indicates system time clock and USB start-of-frame (SOF) token counter

The value for the HLF is always 12. The PTS and the SCR fields are optional. The firmware example populates zeros in these fields.

The bit field header (BFH) keeps changing value at the end of a frame. [Table 5](#) shows the format of the BFH that is a part of the UVC video data header.



# How to implement an image sensor interface using EZ-USB™ FX3 in a USB Video Class (UVC) framework



## USB Video Class (UVC)

**Table 5 Bit field header (BFH) format**

Bit offset	Field name	Description
0	FID	Frame identifier bit toggles at each image frame start boundary and stays constant for the rest of the image frame
1	EOF	End of frame bit indicates the end of a video and is set only in the last USB transfer belonging to an image frame
2	PTS	Presentation time stamp bit indicates the presence of a PTS field in the UVC video data header (1=present)
3	SCR	Source clock reference bit indicates the presence of an SCR field in the UVC video data header (1=present)
4	RES	Reserved, set to 0
5	STI	Still image bit indicates if the video sample belongs to a still image
6	ERR	Error bit indicates an error in the device streaming
7	EOH	End of header bit, when set, indicates the end of the BFH fields

**Figure 7** shows how these headers are added to the video data in this application. The 12-byte header is added for every USB bulk transfer. Here, each USB transfer has a total of 16 bulk packets. The USB 3.0 bulk packet size is 1024 bytes.

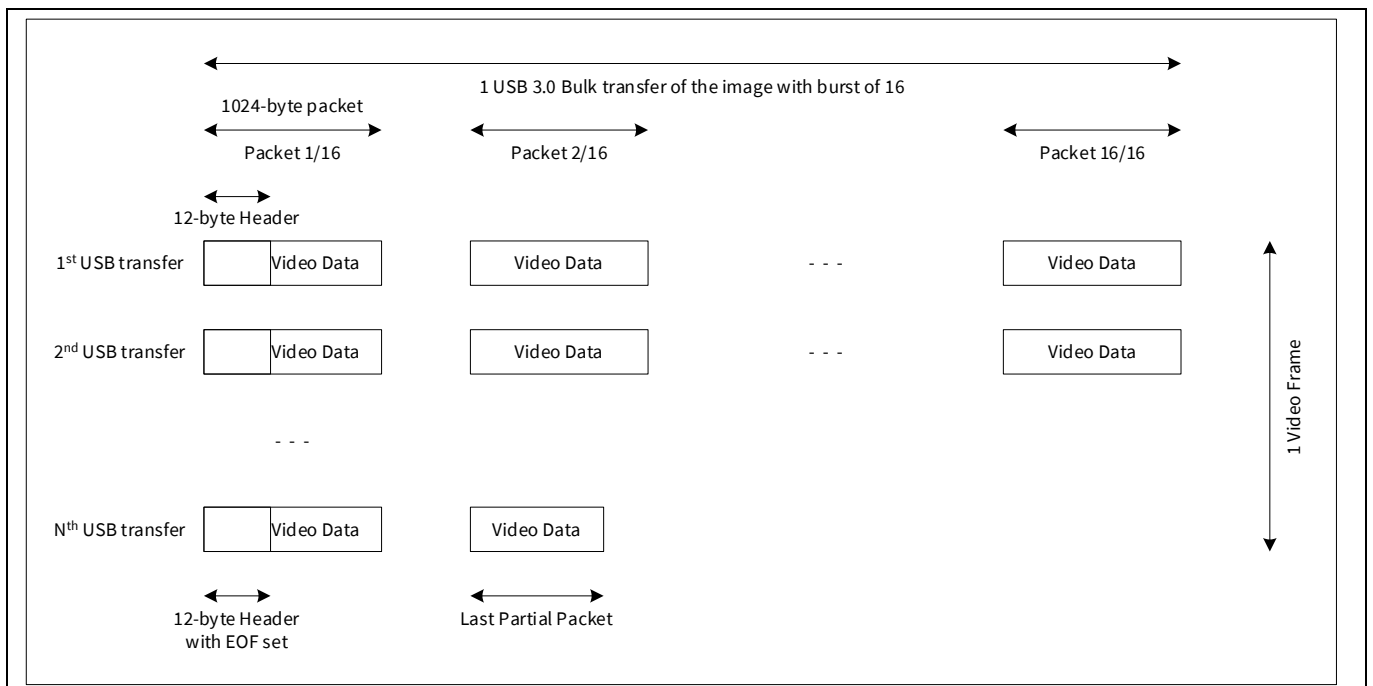

**Figure 7 UVC video data transfers**

### 2.3.5 Still image capture

Video cameras can also support still image capture from a video stream. This can be initiated either by programmatic software triggers or hardware triggers.

There are three supported methods of capturing a still image; the device will have to specify the method it supports in the class-specific descriptors within the relevant video streaming interface descriptor.

In this application note, Method-2 still capture is implemented. See the UVC specification for details on other modes of still capture.

#### 2.3.5.1 Method 2 still image capture

Method 2 still capture adds support for the device to capture still images of a different resolution than the streaming resolution. In this case, the host software will do the following:

1. Temporarily suspends video streaming
2. Selects the optimal bandwidth alternate setting based on the still probe/commit negotiation
3. Sends a VS\_STILL\_IMAGE\_TRIGGER\_CONTROL Set request with the "transmit still image" option (see Section 4.3.1.4, "Still Image Trigger Control" of UVC specification)
4. Prepares to receive the still image data.

The device transmits the still image data marked as such in the payload header. Once the complete still image is received, the host software will then revert back to the original alternate setting, and resume video streaming. For this method, the still image frame need not be the same size as the video frames being streamed.

In the case of software-triggered still capture, the host software initiates the still image capture from the device. It does so by issuing a VS\_STILL\_IMAGE\_TRIGGER\_CONTROL SET request with the "Transmit still image via dedicated bulk pipe" option ("Still Image Trigger Control" of the UVC specification). In this case, after issuing the request, the host will start receiving the still image from the bulk still image endpoint of the relevant video streaming interface. The device captures the still image and transmits the data to the bulk still image endpoint.

In the case of hardware-triggered still capture, the device initiates the still image transmission after detecting a hardware trigger. When the device detects a button press, the status interrupt endpoint will issue an interrupt originating from the relevant video streaming interface. If the **bTriggerUsage** field of the selected **Class-specific VS interface input header descriptor** is set as "initiating still image capture", the device will set the **bTrigger** field of the VS\_STILL\_IMAGE\_TRIGGER\_CONTROL control to "Transmit still image via dedicated bulk pipe". The host software should then begin receiving the still image data that was captured by the device after it received the interrupt.

Still image probe and commit control requests are handled in CY\_FX\_UVC\_STILL\_PROBE\_CONTROL and CY\_FX\_UVC\_STILL\_COMMIT\_CONTROL case statements in the **UVCHandleVideoStreamingRqts** function. Still image capture is implemented in CY\_FX\_UVC\_STILL\_TRIGGER\_CONTROL case statement in the same function.

# How to implement an image sensor interface using EZ-USB™ FX3 in a USB Video Class (UVC) framework



## USB Video Class (UVC)

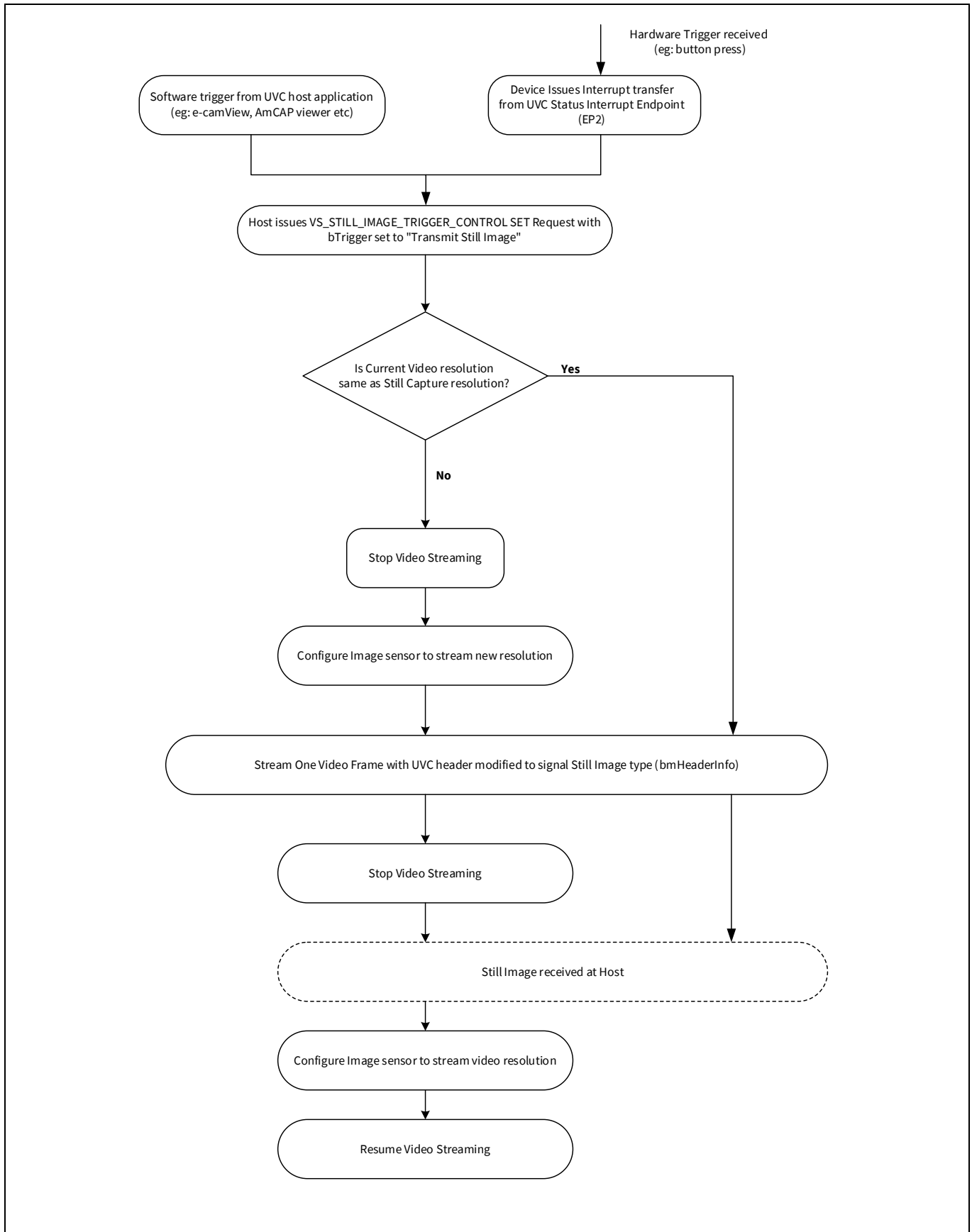

Figure 8 Still capture firmware flow

### 3 GPIF II image sensor interface

The GPIF II block of EZ-USB™ FX3 is a flexible state machine that can be customized to drive the EZ-USB™ FX3 pins to interface with external hardware, such as an image sensor. To design a state machine, you need to understand the interface requirements and EZ-USB™ FX3's DMA capabilities.

#### 3.1 Image sensor interface

A typical image sensor interface is shown in [Figure 2](#). Usually the image sensor requires a reset signal from the EZ-USB™ FX3 controller. This can be handled by using an EZ-USB™ FX3 general-purpose input/output (GPIO).

Image sensors typically use an I<sup>2</sup>C connection to allow a controller to read and write the image sensor parameters. Image sensors may also use the serial peripheral interface (SPI) or the universal asynchronous receiver/transmitter (UART) connection for the same purpose. The I<sup>2</sup>C, SPI, and UART blocks of EZ-USB™ FX3 can provide this function. This application uses I<sup>2</sup>C to configure the image sensor.

To transfer images, the image sensor supplies the following signals:

1. FV: Frame valid (indicates start and stop of a frame)
2. LV: Line valid (indicates start and stop of a line)
3. PCLK: Pixel clock (clock for the synchronous interface)
4. Data: Eight data lines for image data

[Figure 9](#) shows the timing diagrams for the FV, LV, PCLK, and data signals. The image sensor asserts the FV signal to indicate the start of a frame. Then, the image data is transferred line by line. The LV signal is asserted during each line transfer as the image sensor drives 8-bit pixel data in the YUY2 format, which comprises four bytes for every two pixels. Byte data is clocked into the GPIF II unit on each rising edge of PCLK.

The EZ-USB™ FX3 GPIF II bus can be configured for 8-, 16-, or 32-bit data buses. This application uses the image sensor's 8-bit bus. If an image sensor supplies a non-byte-aligned bus, for example a 12-bit bus, use the next size up and either pad or discard the unused bits.

##### 3.1.1 GPIF II interface requirements

Based on the timing diagram ([Figure 9](#)), the GPIF II state machine has the following requirements:

- The GPIF II block must transfer data from the data pins only when LV and FV signals are asserted.
- The image sensor does not provide flow control. Therefore, the interface must transfer a full line of video without interruption. In this design, there are 1280 pixels per line, and each pixel requires 2 bytes, so 2560 bytes transfer per line.
- The CPU must be notified at the end of every frame so it can update the header bits accordingly.

# How to implement an image sensor interface using EZ-USB™ FX3 in a USB Video Class (UVC) framework



## GPIF II image sensor interface

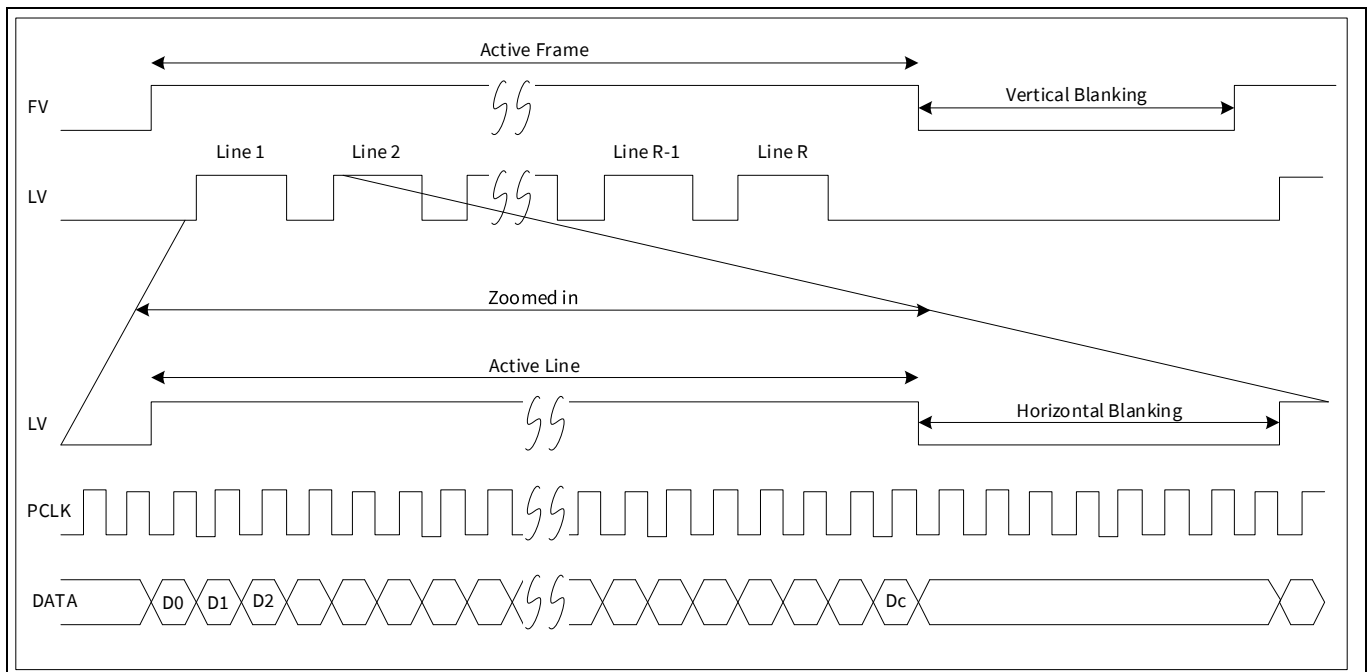

**Figure 9** Image sensor interface timing diagram

### 3.2 Pin mapping of image sensor interface

The GPIF II to image sensor pin mapping is shown in [Table 6](#).

**Table 6** Pin mapping for parallel image sensor interface

EZ-USB™ FX3 pin	Synchronous parallel image sensor interface with 8-bit data bus
GPIO[28]	LV
GPIO[29]	FV
GPIO[0:7]	DQ[0:7]
GPIO[16]	PCLK
I <sup>2</sup> C_GPIO[58]	I <sup>2</sup> C_SCL
I <sup>2</sup> C_GPIO[59]	I <sup>2</sup> C_SDA

Use the pin mapping shown in [Table 7](#) for image sensors that use UART or SPI as an interface and if they use a 16-bit data bus.

**Table 7** Additional pin mapping for image sensors

EZ-USB™ FX3 pin	Image sensor interface (additional pins)
GPIO[8:15]	DQ[8:15]
GPIO[46]	GPIO/UART_RTS
GPIO[47]	GPIO/UART_CTS
GPIO[48]	GPIO/UART_TX
GPIO[49]	GPIO/UART_RX
GPIO[53]	GPIO/SPI_SCK/UART_RTS
GPIO[54]	GPIO/SPI_SSN/UART_CTS

# How to implement an image sensor interface using EZ-USB™ FX3 in a USB Video Class (UVC) framework



## GPIF II image sensor interface

EZ-USB™ FX3 pin	Image sensor interface (additional pins)
GPIO[55]	GPIO/SPI_MISO/UART_TX
GPIO[56]	GPIO/SPI_MOSI/UART_RX

Note: For the complete pin mapping of EZ-USB™ FX3, see the datasheet [EZ-USB™ FX3 SuperSpeed USB controller](#).

### 3.3 Ping-pong DMA buffers

To understand the data transfer in and out of EZ-USB™ FX3, it is important to know the following terminology:

- Socket
- DMA descriptor
- DMA buffer
- GPIF thread

A socket is a point of connection between a peripheral hardware block and the EZ-USB™ FX3 RAM. Each peripheral hardware block on EZ-USB™ FX3, such as USB, GPIF, UART, and SPI, has a fixed number of sockets associated with it. The number of independent data flows through a peripheral is equal to the number of its sockets. The socket implementation includes a set of registers that point to the active DMA descriptor and enable or flag interrupts associated with the socket.

A DMA descriptor is a set of registers allocated in the EZ-USB™ FX3 RAM. It holds information about the address and size of a DMA buffer as well as pointers to the next DMA descriptor. These pointers create DMA descriptor chains.

A DMA buffer is a section of RAM used for intermediate storage of data transferred through the EZ-USB™ FX3 device. DMA buffers are allocated from the RAM by the EZ-USB™ FX3 firmware, and their addresses are stored as part of DMA descriptors.

A GPIF thread is a dedicated data path in the GPIF II block that connects the external data pins to a socket.

Sockets can directly signal each other through events or they can signal the EZ-USB™ FX3 CPU via interrupts. This signaling is configured by firmware. Take, for example, a data stream from the GPIF II block to the USB block. The GPIF socket can tell the USB socket that it has filled data in a DMA buffer, and the USB socket can tell the GPIF socket that a DMA buffer has been emptied. This implementation is called an automatic DMA channel. The automatic DMA channel implementation is typically used when the EZ-USB™ FX3 CPU does not have to modify any data in a data stream.

Alternatively, the GPIF socket can send an interrupt to the EZ-USB™ FX3 CPU to notify it that the GPIF socket filled a DMA buffer. The EZ-USB™ FX3 CPU can relay this information to the USB socket. The USB socket can send an interrupt to the EZ-USB™ FX3 CPU to notify it that the USB socket emptied a DMA buffer. Then the EZ-USB™ FX3 CPU can relay this information back to the GPIF socket. This implementation is called a manual DMA channel. The manual DMA channel implementation is typically used when the EZ-USB™ FX3 CPU has to add, remove, or modify data in a data stream. The firmware example of this application note uses the manual DMA channel implementation because the firmware needs to add UVC video data header.

A socket that writes data to a DMA buffer is called a producer socket. A socket that reads data from a DMA buffer is called a consumer socket. A socket uses the values of the DMA buffer address, DMA buffer size and DMA descriptor chain stored in a DMA descriptor for data management ([Section 4](#)). A socket takes a finite amount of time (up to a few microseconds) to switch from one DMA descriptor to another after it fills or empties a DMA buffer. The socket will not be able to transfer any data while this switch is in progress. This latency can be a problem for interfaces that have no flow control. One such example is an image sensor interface.

# How to implement an image sensor interface using EZ-USB™ FX3 in a USB Video Class (UVC) framework



## GPIF II image sensor interface

This issue is addressed in the GPIF II block through the use of multiple GPIF threads. The GPIF II block implements four GPIF threads. Only one GPIF thread can transfer data at a time. The GPIF II state machine must select an active GPIF thread to transfer data.

The GPIF thread selection mechanism is like a MUX. The GPIF II state machine uses internal control signals or external inputs to select the active GPIF thread. In this example, this switching between GPIF threads is controlled by the internal control signals. Switching the active GPIF thread will switch the active socket for the data transfer, thereby changing the DMA buffer used for data transfers. The GPIF thread switch has no latency. The GPIF II state machine can implement this switch at the DMA buffer boundary, masking the latency of the GPIF socket switching to a new DMA descriptor. This allows the GPIF II block to take in data from the sensor, without any loss, when the DMA buffer is filled up.

**Figure 10** shows the sockets, the DMA descriptors, and the DMA buffer connections used in this application along with the data flow. Two GPIF threads are used to fill in alternate DMA buffers. These GPIF threads use separate GPIF sockets (acting as producer sockets) and DMA descriptor chains (descriptor chain 1 and descriptor chain 2). The USB socket (acting as a consumer socket) uses a different DMA descriptor chain (descriptor chain 3) to read the data out in the correct order.

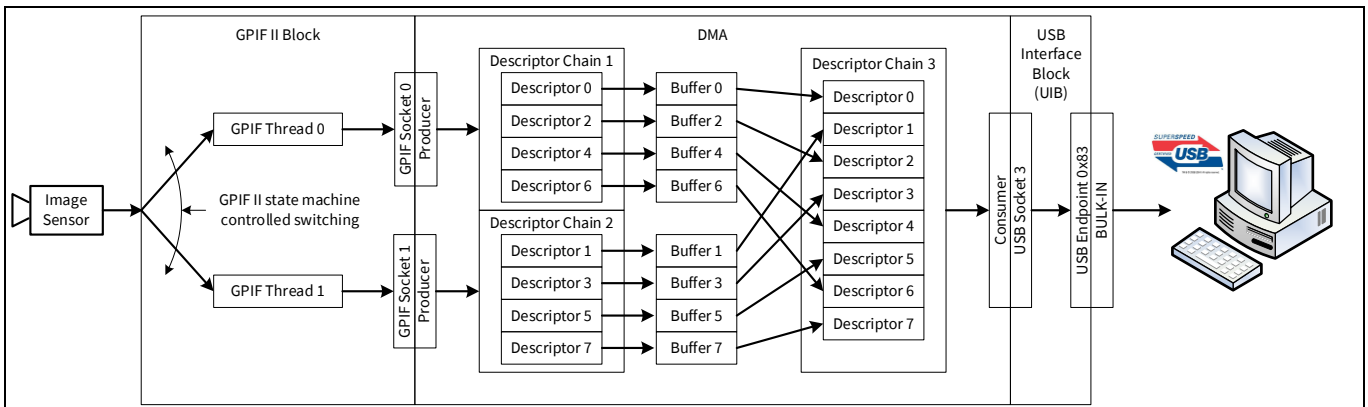

**Figure 10** FX3 data transfer architecture

### 3.4 Design strategy

Before building the detailed GPIF II state machine, it is useful to consider the basic transfer strategy.

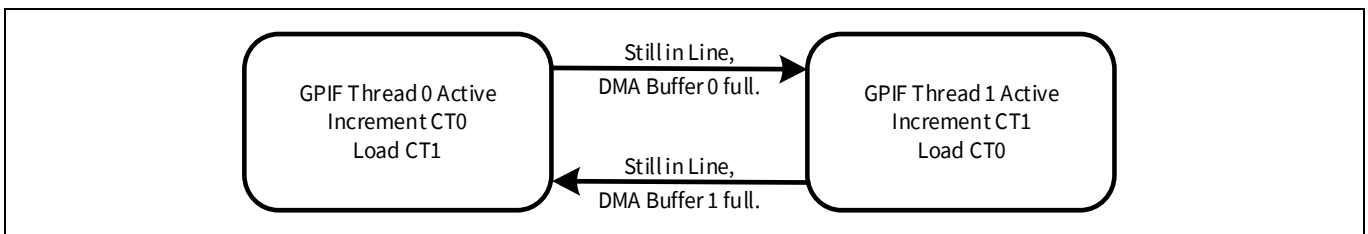

**Figure 11** Data transfer within a video line

**Figure 11** shows the basic DMA buffer ping-pong action when a DMA buffer fills during an active horizontal line. The GPIF II state machine has three independent counters. In this example, the GPIF II unit maintains two counters, CT0 and CT1, to count the number of bytes written to a DMA buffer. When the count reaches the DMA buffer limit, the “DMA buffer full” branch is taken and the GPIF II switches GPIF threads. As bytes are transferred in one GPIF thread, the counter for the other GPIF thread is initialized to prepare the counter to count bytes after the next GPIF thread switch occurs.

# How to implement an image sensor interface using EZ-USB™ FX3 in a USB Video Class (UVC) framework



## GPIF II image sensor interface

When the image sensor de-asserts LV, it has reached the end of a video line. At this moment, the state machine has several options, as shown in **Figure 12**, where LV is the Line Valid signal and FV is the frame valid signal. The choices depend on whether a DMA buffer has just filled and if the frame has just completed.

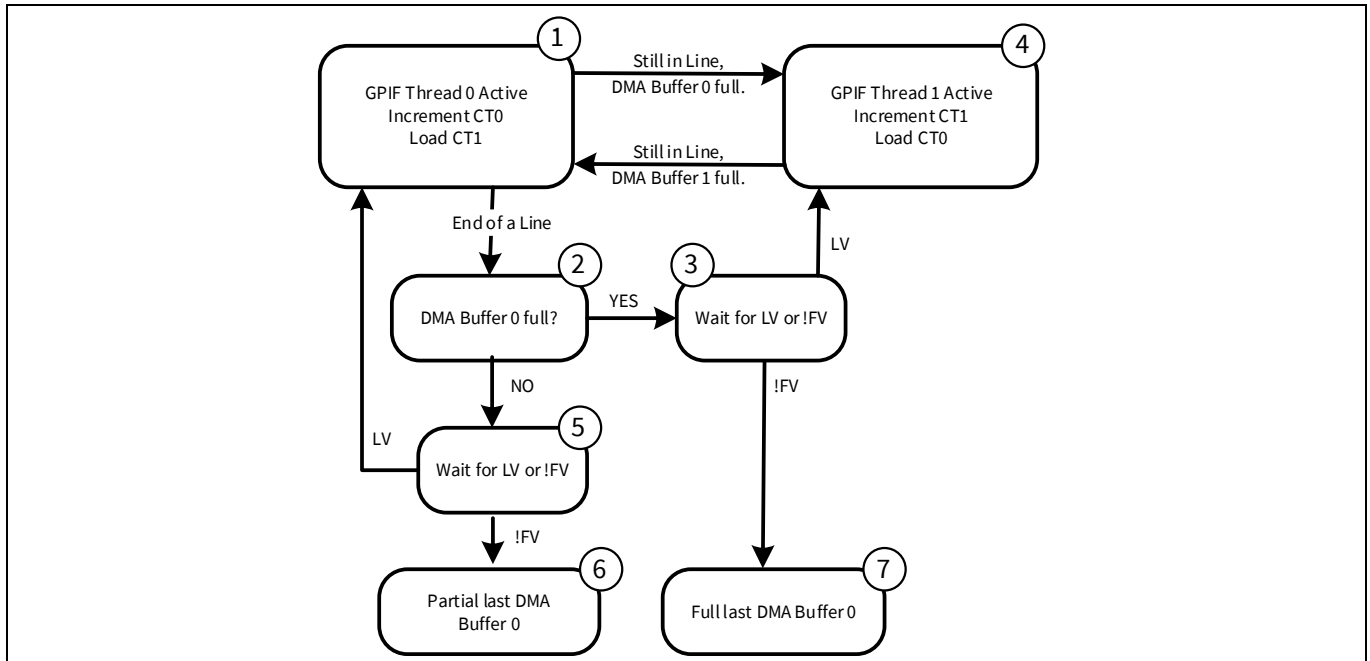

**Figure 12** Data transfer decisions at the end of a video line

*Note:* A mirror image decision tree starting with “End of a Line” also emanates from state 4; this was omitted from the diagram for the sake of clarity.

At the end of a line (LV=0), the state machine transitions from state 1 to state 2 where it checks the DMA buffer byte counter to determine if the DMA buffer is full. If it is, the state machine proceeds to state 3. In state 3, if FV is low, a full frame has transferred and state 7 is entered. In state 7, the CPU is alerted via an interrupt request that signifies a full last DMA buffer. Using this information, the CPU can set up the GPIF II for the next frame.

If FV=1 in state 3, the image sensor is still transferring a frame, and it will soon reassert LV=1 to indicate the next video line. When LV=1, the state machine transitions from state 3 to state 4, performing the same GPIF thread switch as it does in the state 1 to state 4 transition. Thus, the paths 1-4 and 1-2-3-4 both result in a GPIF thread switch. The difference between these paths is that the second path takes an extra cycle because it has an intervening end-of-line pause.

If the DMA buffer is not full, the state machine moves from state 2 to state 5. In state 5, as in state 3, it waits either for the end of the frame or for reassertion of LV (onset of the next video line). If LV=1, it continues to fill DMA buffer 0 in state 1. If FV=0, the image sensor has finished sending a video frame and the DMA buffer 0 is only partially filled. In state 6, the state machine raises a different interrupt to the CPU to allow it to account for sending a short DMA buffer over USB.

### 3.5 GPIF II state machine

The EZ-USB™ FX3 GPIF II is a programmable state machine that can have up to 256 states. Each state can perform actions, including the following:

- Drive multiple control lines
- Send or receive data and/or address



# How to implement an image sensor interface using EZ-USB™ FX3 in a USB Video Class (UVC) framework



## GPIF II image sensor interface

- Send interrupts to the internal CPU

State transitions can depend on internal or external signals, such as DMA ready, and the image sensor's frame/line Valid.

To begin the GPIF II state machine design, choose a point in the image sensor waveform for the state machine to start. The start of a frame, indicated by a positive FV transition, is a logical starting point. GPIF II detects this edge by first waiting for FV=0 (first state) and then waiting for FV=1 (second state). The second state also initializes a transfer counter to correspond to one DMA buffer full of video data. The state machine tests the counter value and switches GPIF threads (DMA buffers) when the counter limit is reached. The counter limit is reached when a DMA buffer fills.

The state machine uses two GPIF II internal counters to count DMA buffer bytes: the GPIF II address counter ADDR and the data counter DATA. Whenever the GPIF II state machine switches GPIF threads, it initializes the appropriate counter for the other GPIF thread. Because loading a counter limit takes one clock cycle, the loaded value is one less than the terminal count.

The transfer counters increment by one every clock cycle. Therefore, depending on the data bus width of the interface, the value of the counter limit would change. For this example, the data bus width is 8 bits and the DMA buffer size is 16,368 bytes, as explained in [Section 5.6](#), so the programmed limit should be 16,367. In general, the DMA buffer count limit is:

$$count = \left( \frac{producer\_buffer\_size(L)}{data\_bus\_width} \right) - 1$$

Therefore, for a 16-bit interface, the DMA buffer size is 8184 16-bit words, so the programmed limit would be 8183. For a 32-bit interface, the DMA buffer size is 4092 32-bit words, so the programmed limit would be 4091.

The detailed GPIF II state machine is shown in [Figure 13](#). The two DMA buffer byte counters are the GPIF II DATA and ADDR counters. These counters correspond to CT0 and CT1, which are shown in [Figure 12](#).

# How to implement an image sensor interface using EZ-USB™ FX3 in a USB Video Class (UVC) framework



## GPIF II image sensor interface

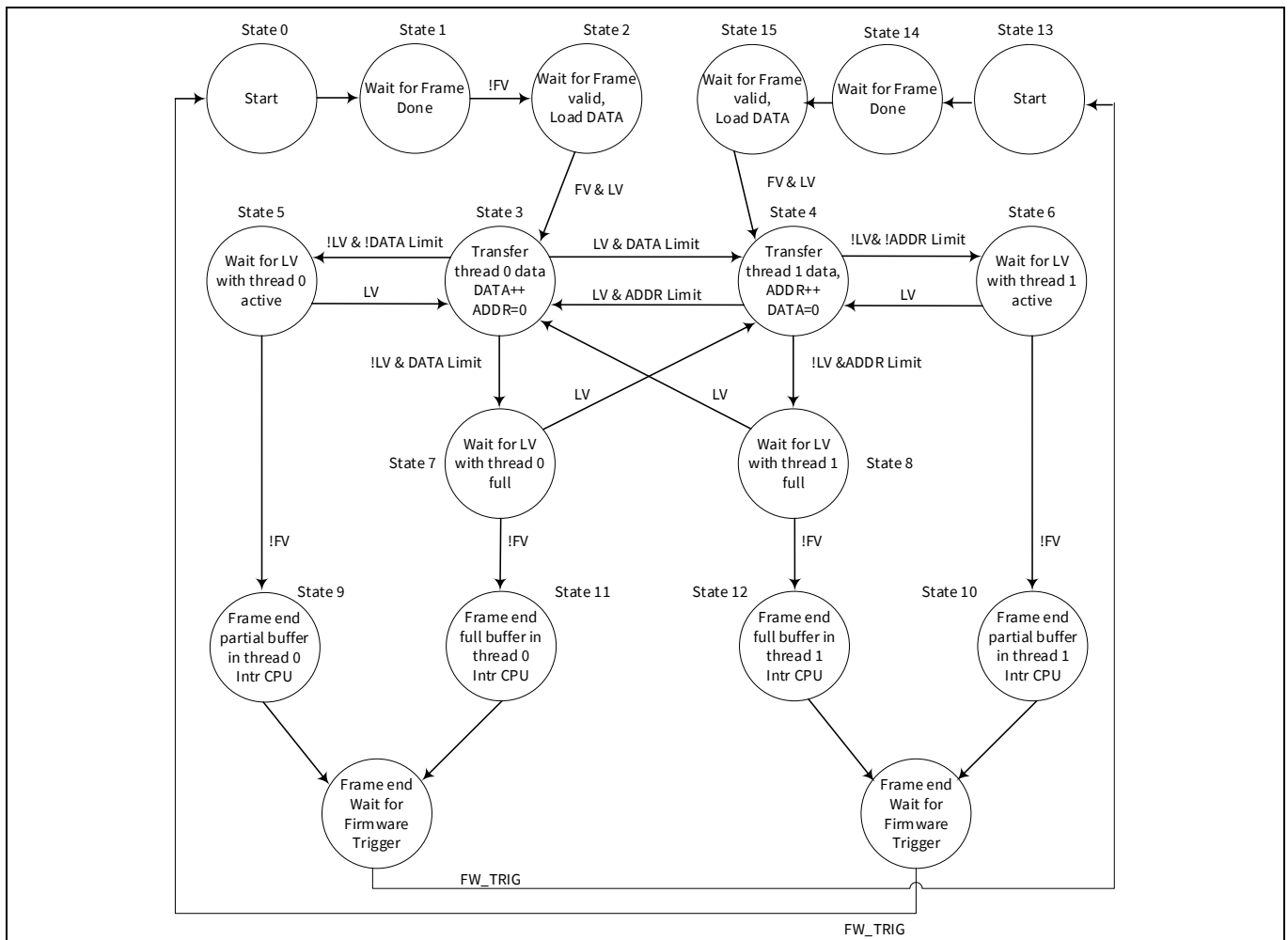

**Figure 13** GPIF II state machine diagram

At the end of every frame, the CPU receives one of four possible interrupt requests, indicating the DMA buffer number and fullness (states 9-12). These requests can be used to implement callback functions, which enable the CPU to handle several tasks, including the following:

1. Commit the last DMA buffer for USB transfer if there is a partial DMA buffer at the end of a frame (states 9 and 10). If the DMA buffer was full at the end of the frame, the GPIF II automatically committed it for USB transfer (states 11 and 12).
2. Wait for the consumer socket (USB) to transmit the last of the DMA buffer data; then reset the channel and the GPIF II state machine to state 0 to prepare it for the start of the next frame.
3. Handle any special application-specific tasks to indicate the frame advance. The UVC requires indicating the change-of-frame event by toggling a bit in the 12-byte header.

**Figure 14** connects image sensor waveforms to GPIF II states for a small portion of a horizontal line. The “Step” line deals with the DMA system, which is described in [Section 4](#) with [Figure 46](#).

## GPIF II image sensor interface

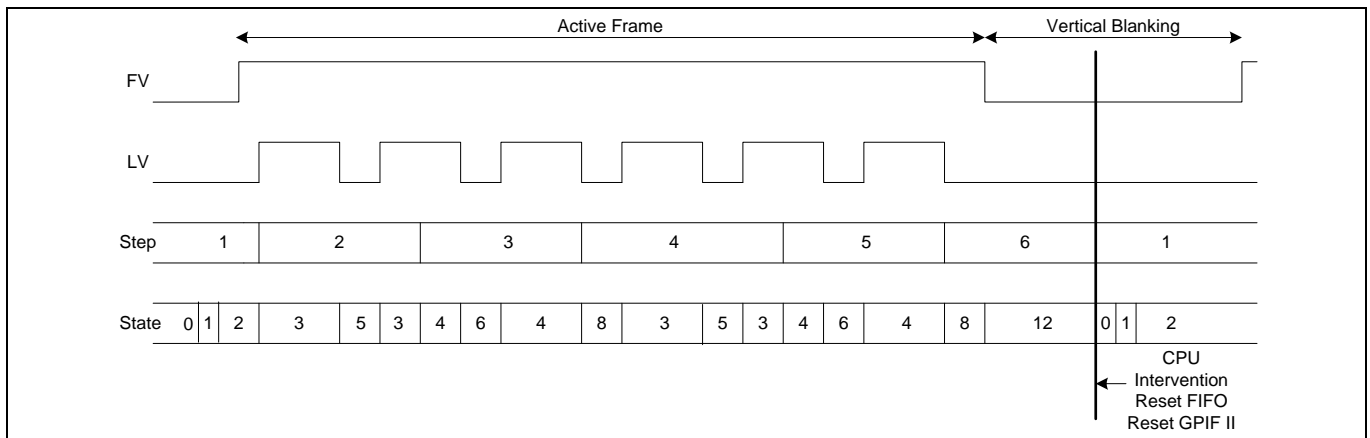

**Figure 14** Image sensor interface, data path execution, and state machine correlation

### 3.6 Implementing image sensor interface using GPIF II designer

This section describes the design of the image sensor interface using the GPIF II designer. For reference, the completed project is available in the “**fx3\_uvc.cydsn**” directory path inside the zip file of the attached source.

The design process involves three steps:

1. Create a project using the GPIF II designer
2. Choose the interface definition
3. Draw the state machine on the canvas

#### 3.6.1 Create the project

Start GPIF II designer. The GUI appears as **Figure 15**. Follow the step-by-step instructions as indicated in the following figures. Each figure includes sub-steps. For advance information on any of the steps, see the **GPIF II designer user guide**.

# How to implement an image sensor interface using EZ-USB™ FX3 in a USB Video Class (UVC) framework



## GPIF II image sensor interface

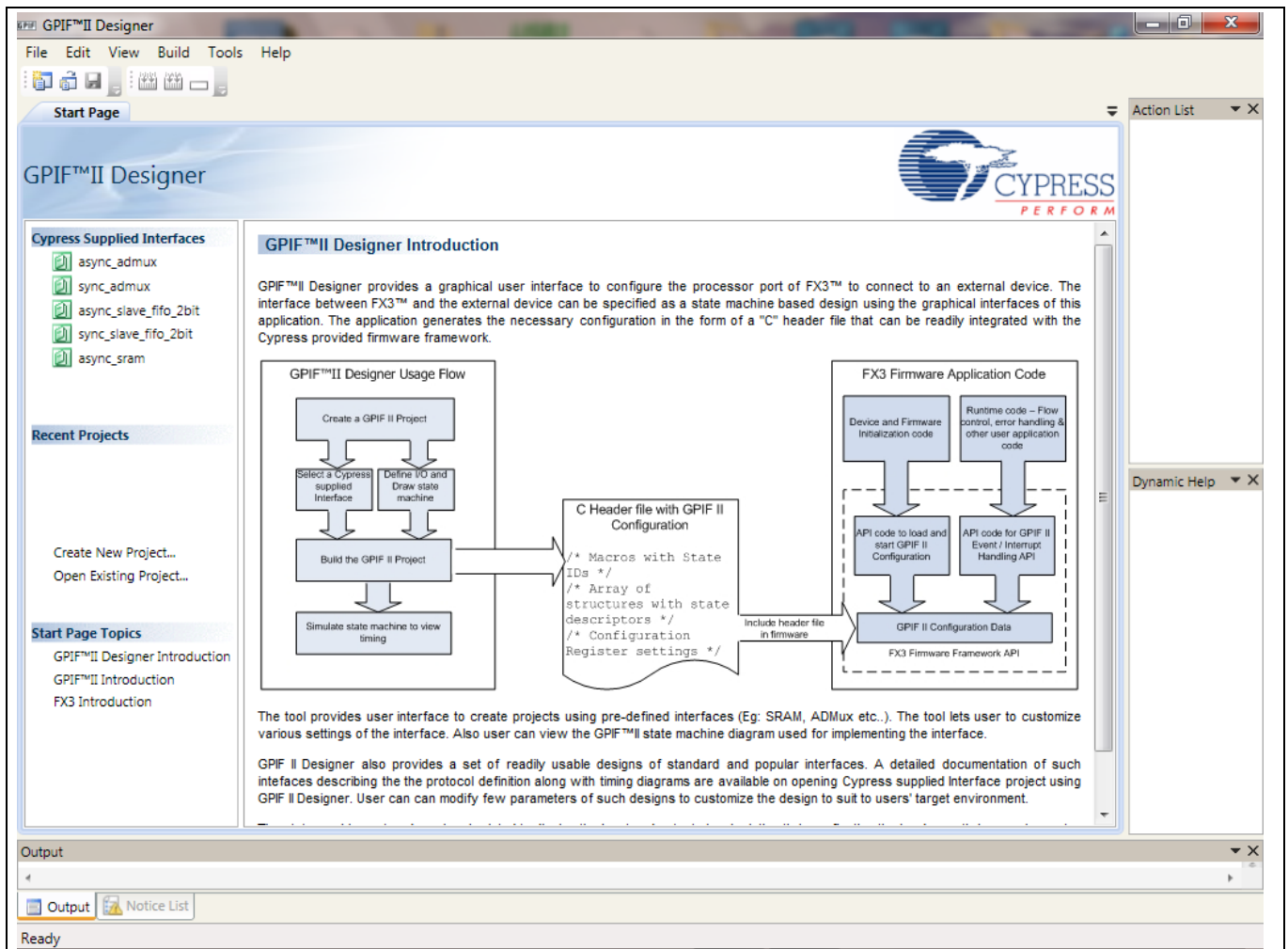

Figure 15 Start GPIF II designer

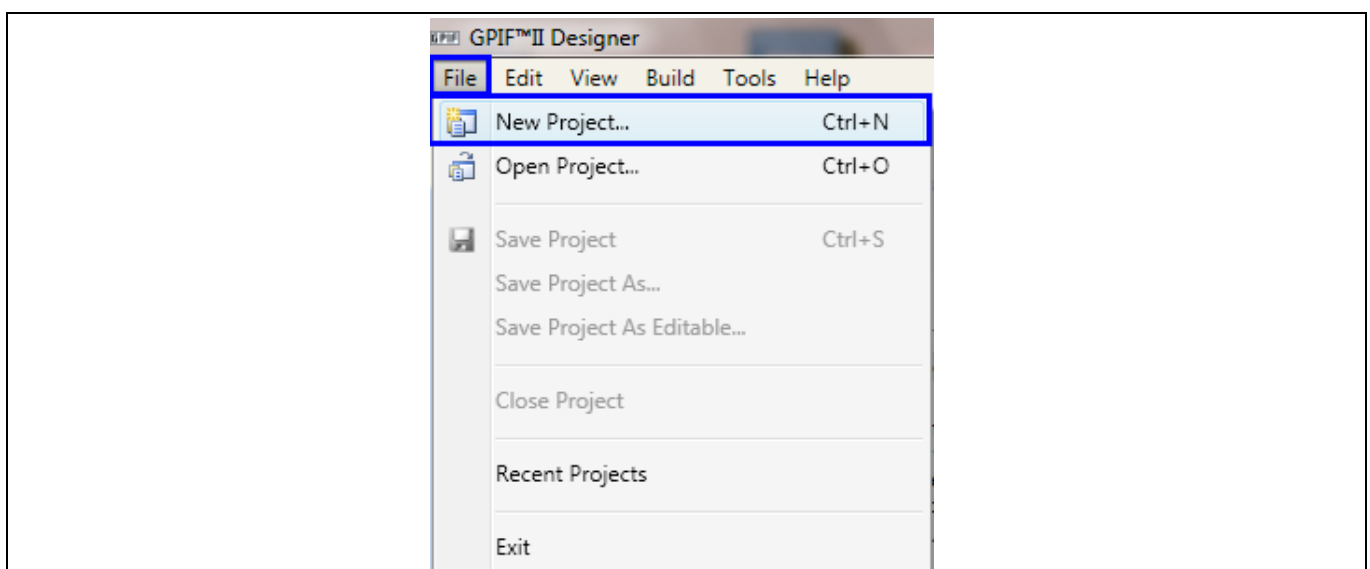
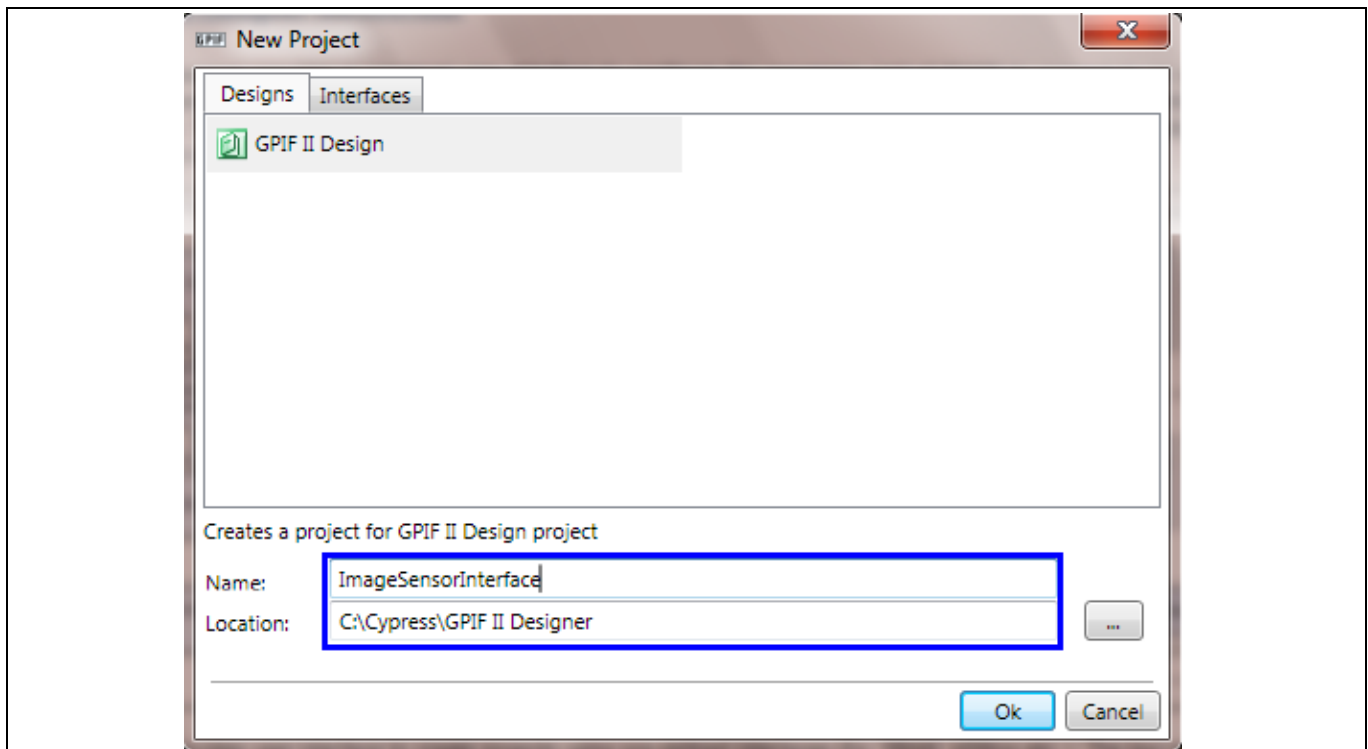

Figure 16 Open File menu and select New Project



**Figure 17** Enter project name and location

The project creation is now complete, and the GPIF II designer opens up access to the **Interface definition** and **State Machine** tabs. In the **Interface Definition** tab, the EZ-USB™ FX3 is on the left and the image sensor (labeled “Application Processor”) is on the right. The next step is to set the interface between the two.

### 3.6.2 Define the interface

In this project, the image sensor connected to the EZ-USB™ FX3 device has an 8-bit data bus. It uses GPIO 28 for the LV signal, GPIO 29 for the FV signal, and GPIO 22 for sensor reset as an active low input (**Table 6**). This image sensor also uses an I<sup>2</sup>C connection to EZ-USB™ FX3 to access image sensor registers, for example, to configure the sensor for 720p mode. The “Interface Settings” column provides the necessary choices.

In addition, the indicated input signals become available in the next phase to create transition equations.

**Figure 18** shows the interface settings to choose.

1. In **Signals**, choose two inputs for LV and FV.
2. In **Signals**, choose one output for nSensor\_Reset.
3. In **FX3 peripherals used**, select I<sup>2</sup>C. This activates the EZ-USB™ FX3 I<sup>2</sup>C master.
4. In **Interface type**, select **Slave**. Because the image sensor supplies the clock and drives the data bus, the GPIF II acts as a slave device.
5. In **Communication type**, select **Synchronous**. This reflects the presence of a synchronizing clock from the image sensor.
6. In **Clock settings**, select **External**. The image sensor supplies its PCLK signal to the GPIF II.
7. In **Active clock edge**, select **Positive**. The image sensor references data transitions to its positive edge.
8. In **Endianness**, select **Little endian**. Endianness refers to the byte ordering in data buses wider than one byte. For an 8-bit interface, this setting doesn't matter.
9. In **Address/data bus usage**, select **8 bit**. The image sensor supplies an 8-bit data bus.

# How to implement an image sensor interface using EZ-USB™ FX3 in a USB Video Class (UVC) framework



## GPIF II image sensor interface

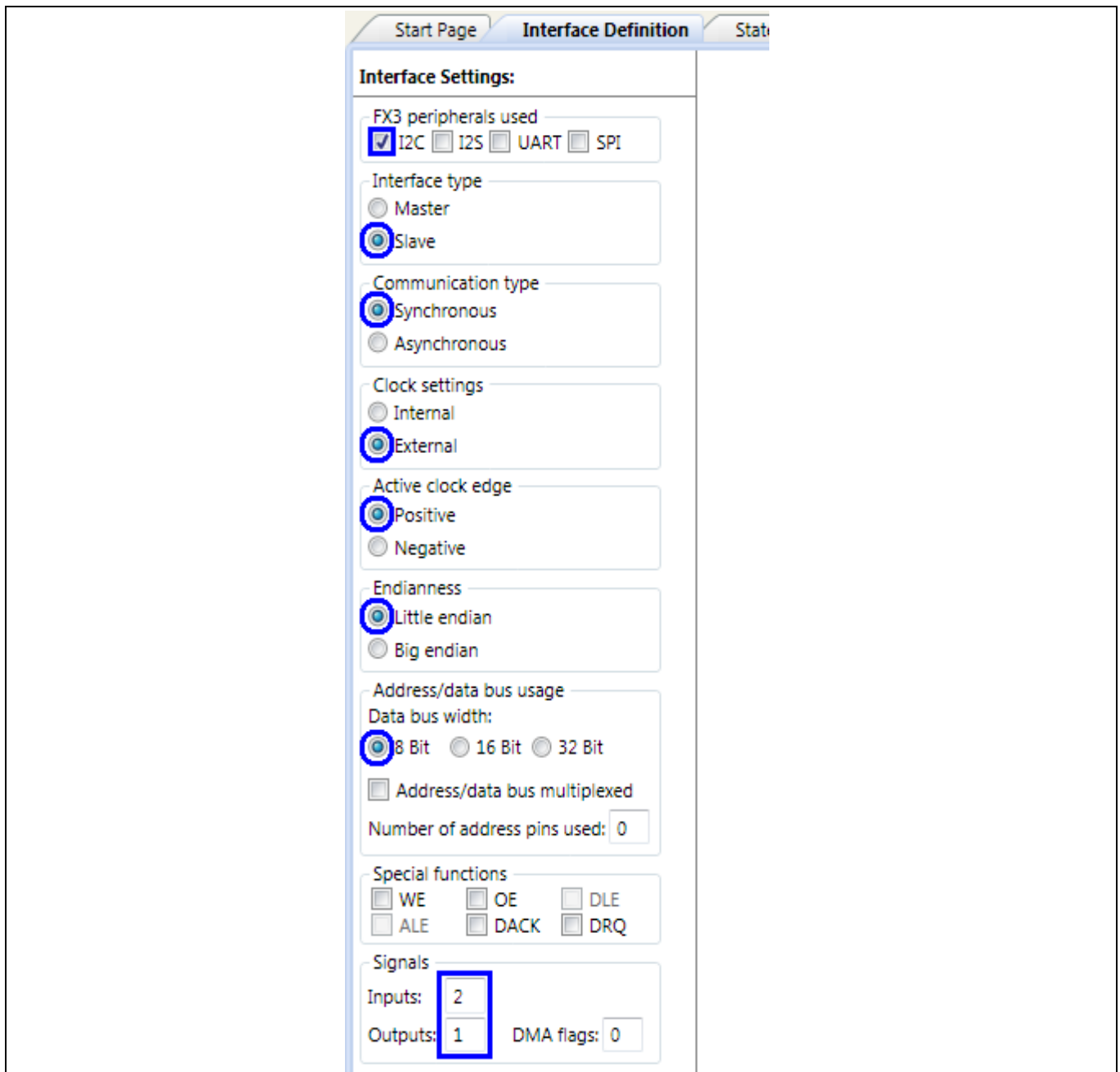

**Figure 18** Interface setting selections

The “I/O Matrix configuration” should now look like [Figure 19](#). The next step is to modify the properties of the input and the output signals. The properties include the name of the signals, the pin mapping (i.e., which GPIO acts as the input or the output), the polarity of the signal, and the initial value of the output signal.

# How to implement an image sensor interface using EZ-USB™ FX3 in a USB Video Class (UVC) framework



## GPIF II image sensor interface

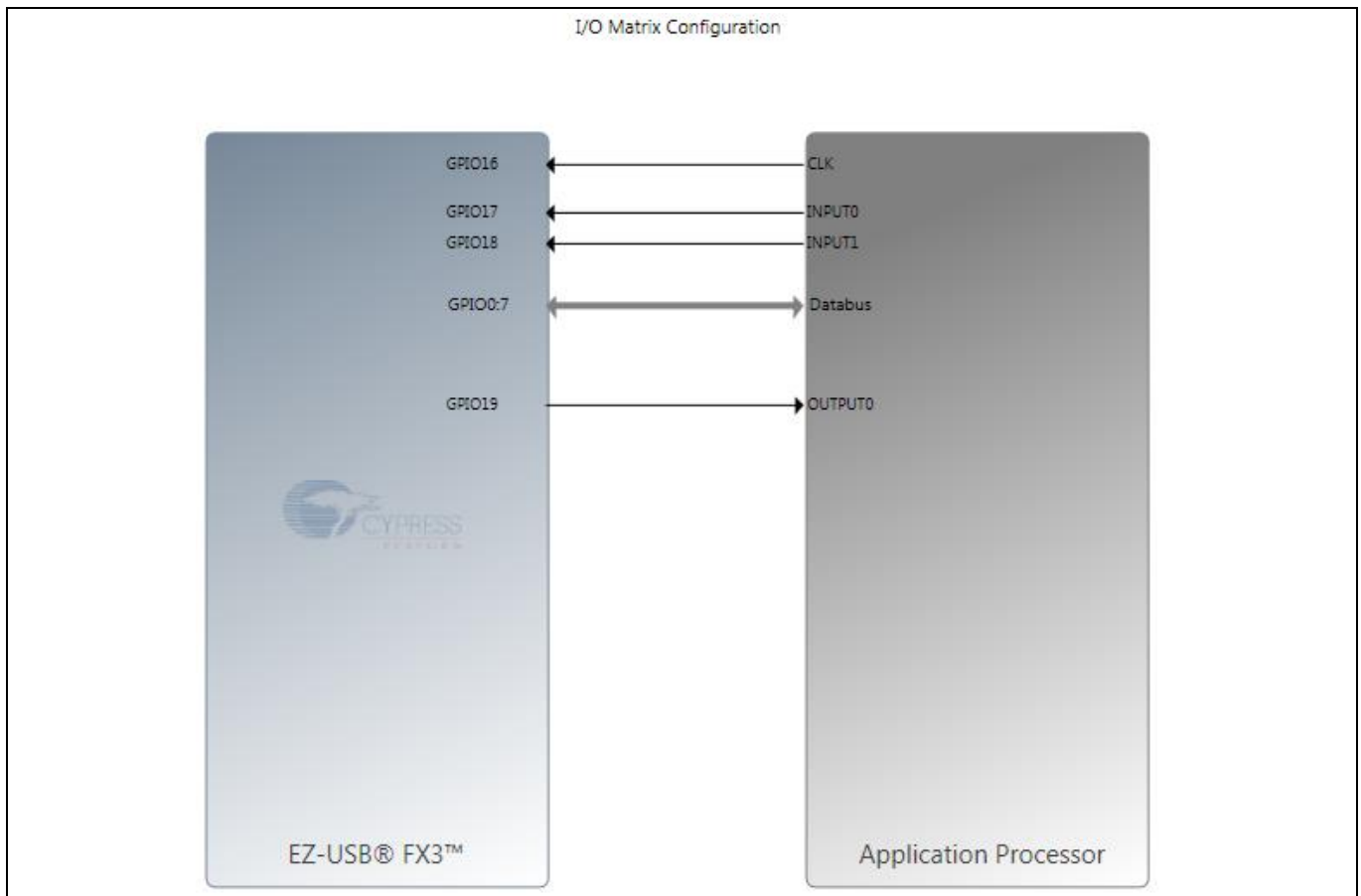

Figure 19 The block diagram so far

Double-click the INPUT0 label in the **Application Processor** area to open the properties for that input signal, as **Figure 20** shows.

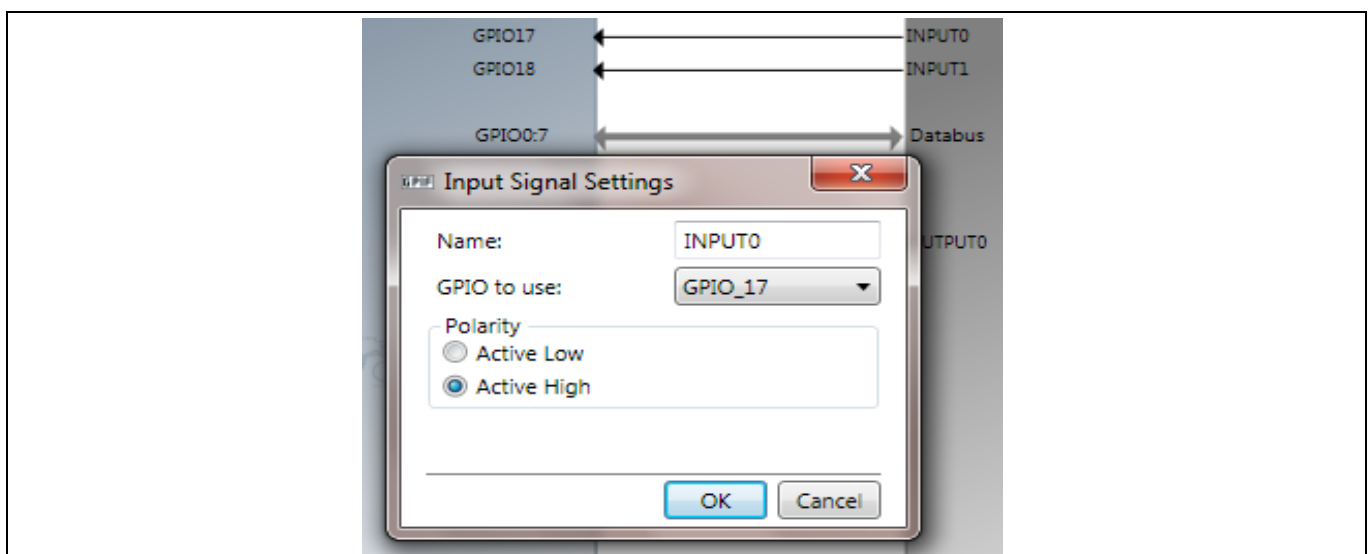

Figure 20 INPUT0 default properties

Change the name of the signal to **LV**, and change **GPIO to use:** to **GPIO\_28** (**Table 6**). Keep the polarity as **Active High**. The properties now appear as shown in **Figure 21**. Click OK.

# How to implement an image sensor interface using EZ-USB™ FX3 in a USB Video Class (UVC) framework



## GPIF II image sensor interface

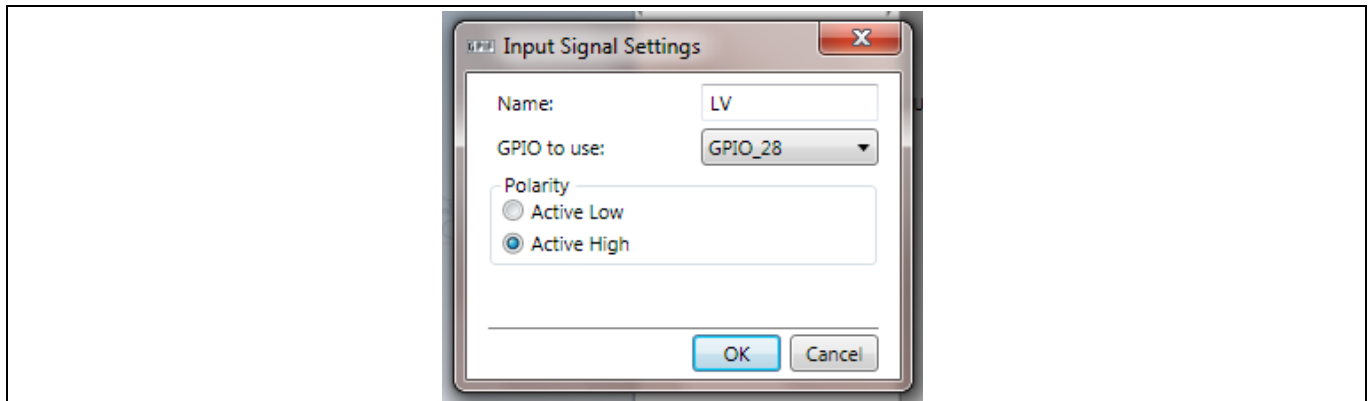

**Figure 21** Edited INPUT0 properties

Next, double-click the INPUT1 label, change the name to **FV** and the GPIO assignment to **GPIO\_29**, and keep the polarity as **Active High** (Figure 22).

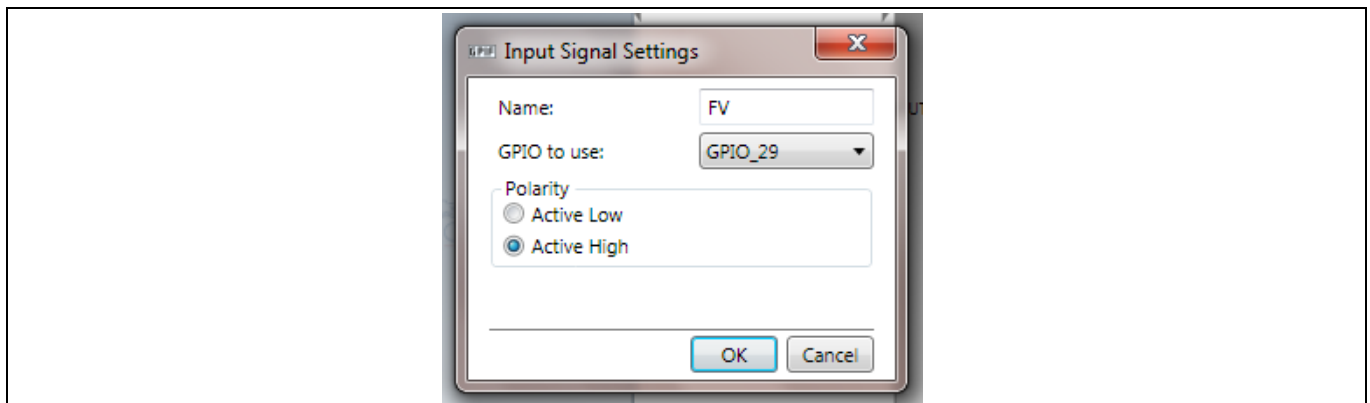

**Figure 22** Edited INPUT1 properties

Double-click the OUTPUT0 label and change the settings according to Figure 23.

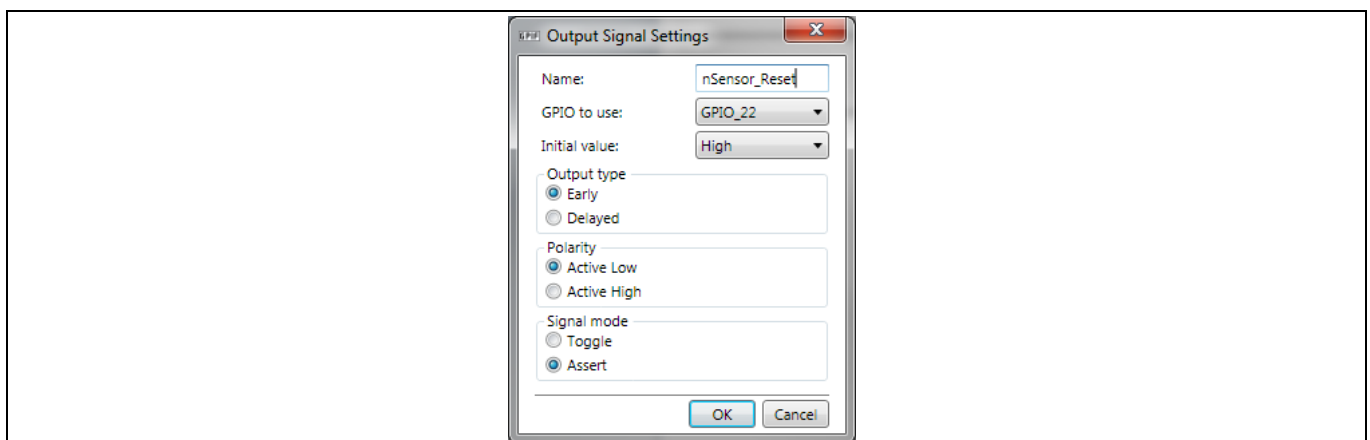

**Figure 23** Edited OUTPUT0 properties



# How to implement an image sensor interface using EZ-USB™ FX3 in a USB Video Class (UVC) framework



## GPIF II image sensor interface

This completes the interface settings. As you set properties, such as signal names, all other parts of the GPIF II designer will update to reflect the changes. For example, the block diagram now has signal names instead of generic input and output names. Also, as you use the state machine designer, the available signal options, for example the LV and FV signals, automatically appear as choices in drop-down lists.

### 3.6.3 Draw the state machine

Click the **State Machine** tab to open the state machine canvas. State machine design involves three basic operations:

1. Create states
2. Add actions within the states
3. Create transitions between states using conditions required to make the transitions

### 3.6.4 Draw the GPIF II state machine

Click the **State Machine** tab to open the canvas. An unedited canvas has two states: START and STATE0. An unconditional transition (LOGIC\_ONE) connects the states ([Figure 24](#)).

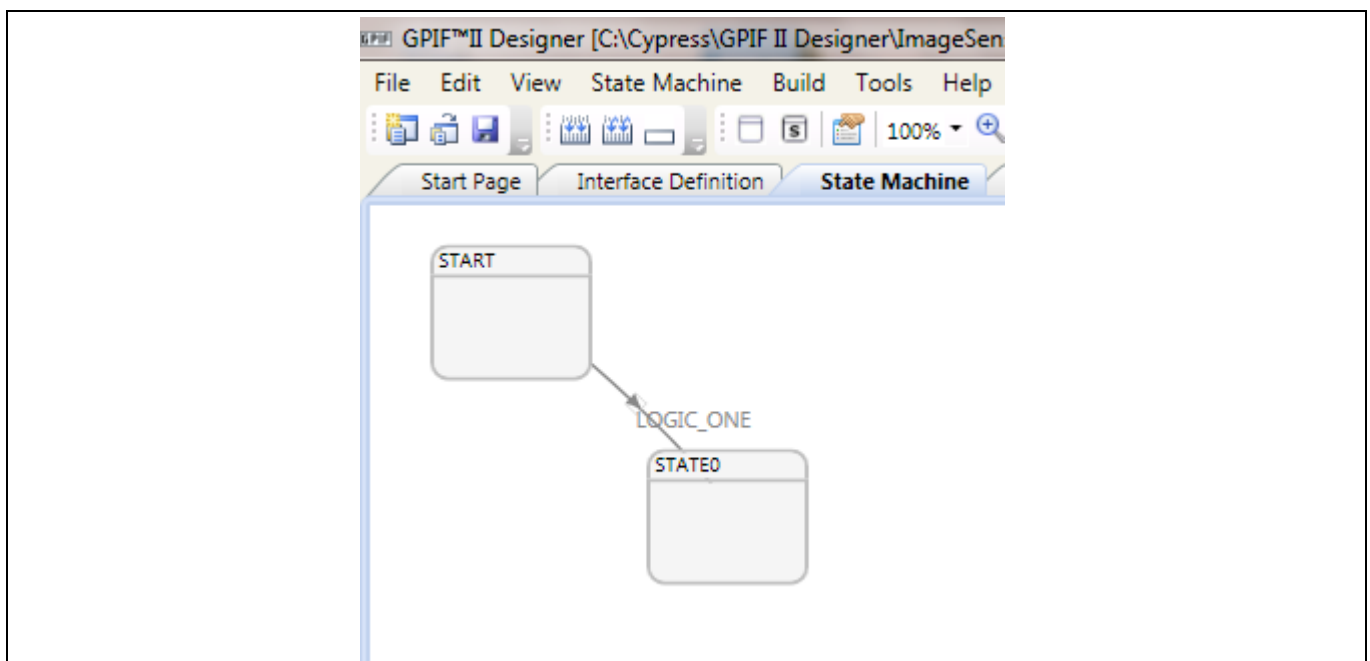

**Figure 24** Initial state machine canvas

1. Edit the name of START state to START\_SCK0 by double-clicking inside the START box and editing the name text box. Similarly edit the name of STATE0 state to IDLE\_SCK0. The “Repeat actions until next transition” determines if an action occurs once when the state is entered or if it occurs on every clock while inside the state. For states with no actions, such as this one, the checkbox state is irrelevant.
2. Add a new state by right-clicking an empty spot in the canvas and selecting “Add State”. Double-click inside this new state and change its name to WAIT\_FOR\_FRAME\_START\_0.
3. Create a transition from the IDLE state to the WAIT\_FOR\_FRAME\_START\_0 state. Position the cursor in the center of the IDLE state box. The cursor changes to a + sign to indicate transition entry. Drag the mouse to the center of the WAIT\_FOR\_FRAME\_START\_0 state. A small selection square appears inside the state box to help locate its center. If the mouse is released anywhere but in the center of the state box, the transition is not created. Try again. Notice that the state transition does not yet have any conditions.

# How to implement an image sensor interface using EZ-USB™ FX3 in a USB Video Class (UVC) framework



## GPIF II image sensor interface

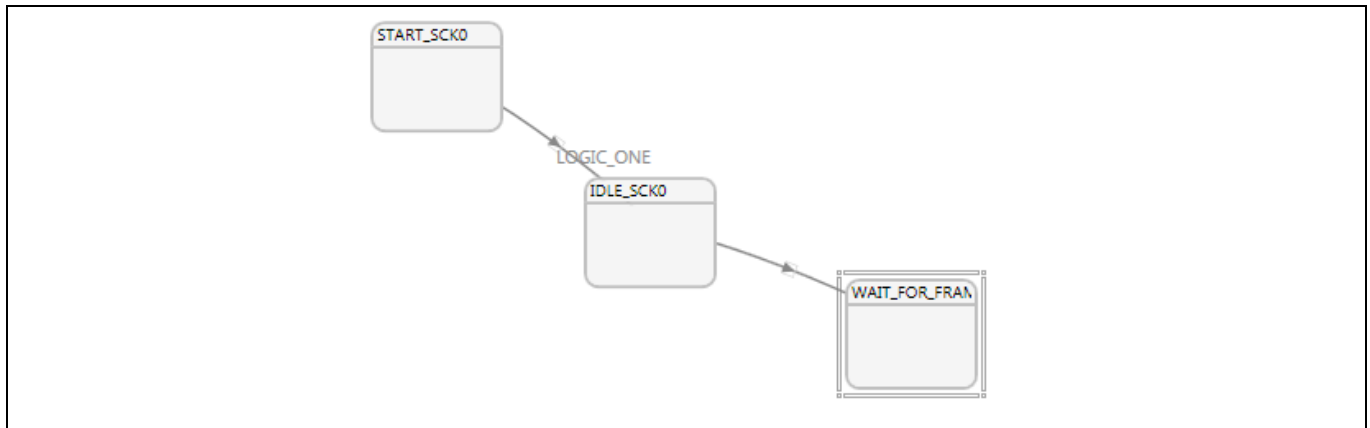

**Figure 25 Results of steps 1-3**

4. Edit the equation for the transition from IDLE\_SCK0 to WAIT\_FOR\_FRAME\_START\_0 by double-clicking on the transition line (**Figure 26**). Notice that LV and FV appear as equation terms to correspond to the renamed block diagram signals. To select FV low, build the equation using buttons and signal selections. Click the Not button, and the “!” symbol appears in the Equation Entry window. Then select the FV signal and click the “Add” button (or double-click the FV entry) to create the final “!FV” equation. You could also directly enter the equation by typing “!FV” in the Equation Entry window. The transition now appears as shown in **Figure 27**.

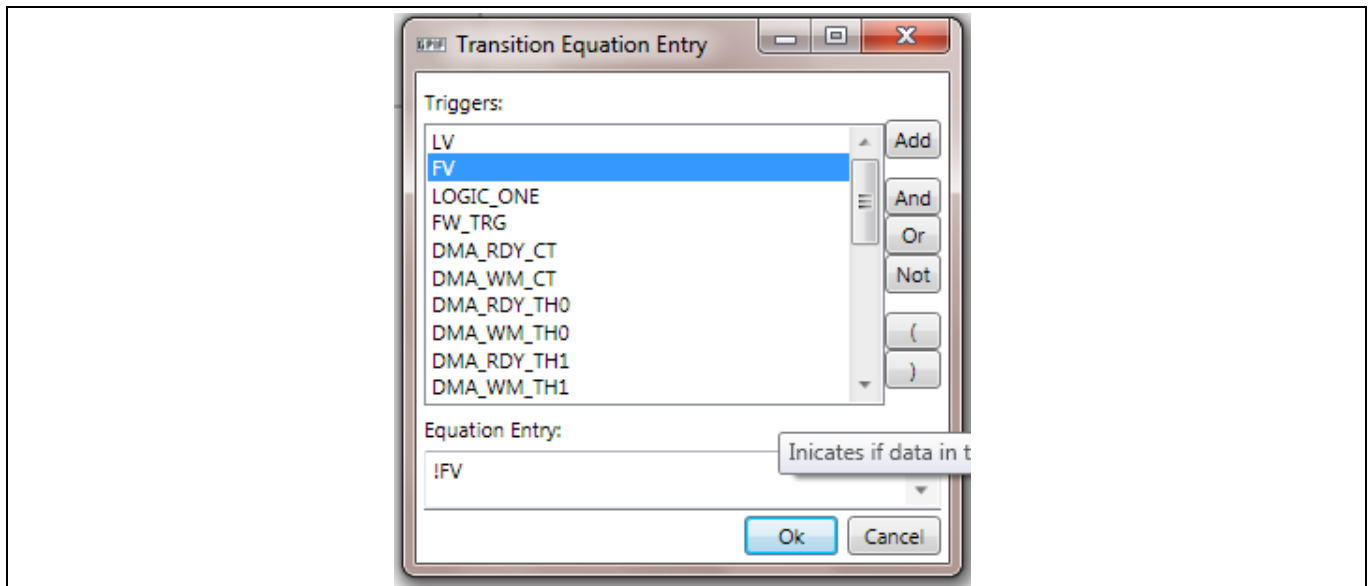
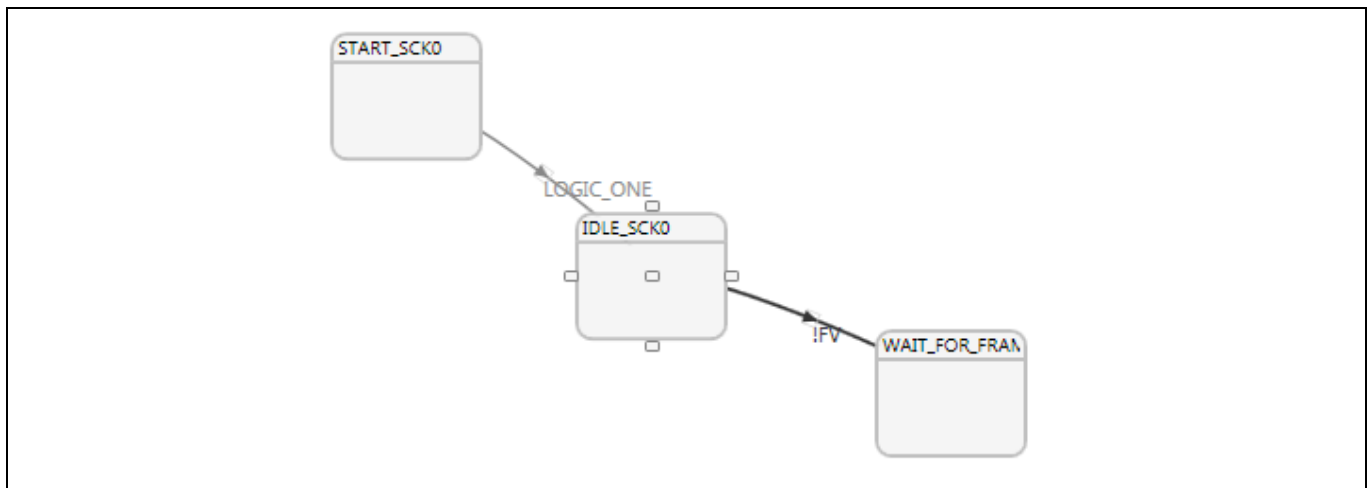

**Figure 26 Double-Clicking a transition line brings up this window**

# How to implement an image sensor interface using EZ-USB™ FX3 in a USB Video Class (UVC) framework



## GPIF II image sensor interface



**Figure 27** The edited transition

5. In the WAIT\_FOR\_FRAME\_START\_0 state, we want to initialize our two byte counters because counters must be initialized in a state that precedes the state that increments them. Recall that this design uses the DATA counter for the Socket 0 buffer and the ADDR counter for the Socket 1 buffer. The “Action List” window in GPIF II designer’s top-right window displays the action choices. To add an action to a state, drag its name in the Action List into the state box. Drag the LD\_DATA\_COUNT and LD\_ADDR\_COUNT actions into the WAIT\_FOR\_FRAME\_START\_0 state box.
6. To edit action properties, double-click the action name inside the state box. Edit the properties of both actions as shown in **Figure 28**. The “Counter mask event” checkbox disables an interrupt request when the counter reaches its limit value.

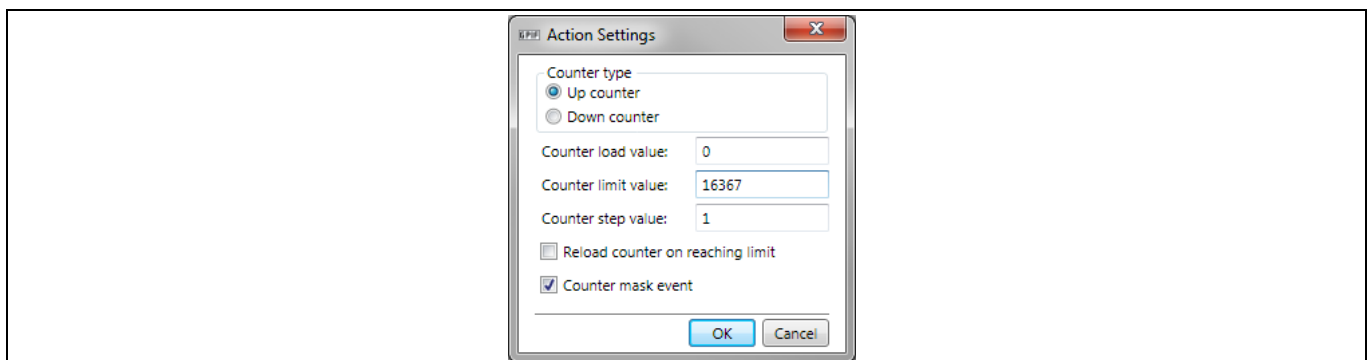

**Figure 28** LD\_DATA/ADDR\_COUNT action settings

7. Similar to the previous step, create states START\_SCK1, IDLE\_SCK1 and WAIT\_FOR\_FRAME\_START\_1.
8. Add a new state with the name PUSH\_DATA\_SCK0 (Push image sensor data into Socket 0). This state transfers one image sensor byte per clock into the GPIF II interface, which routes it to Socket 0.
9. Create a transition from the WAIT\_FOR\_FRAME\_START\_0 state to the PUSH\_DATA\_SCK0 state.
10. Edit this transition equation entry to occur when FV and LV are both asserted by creating the equation FV&LV. The resulting state transition is shown in **Figure 29**.

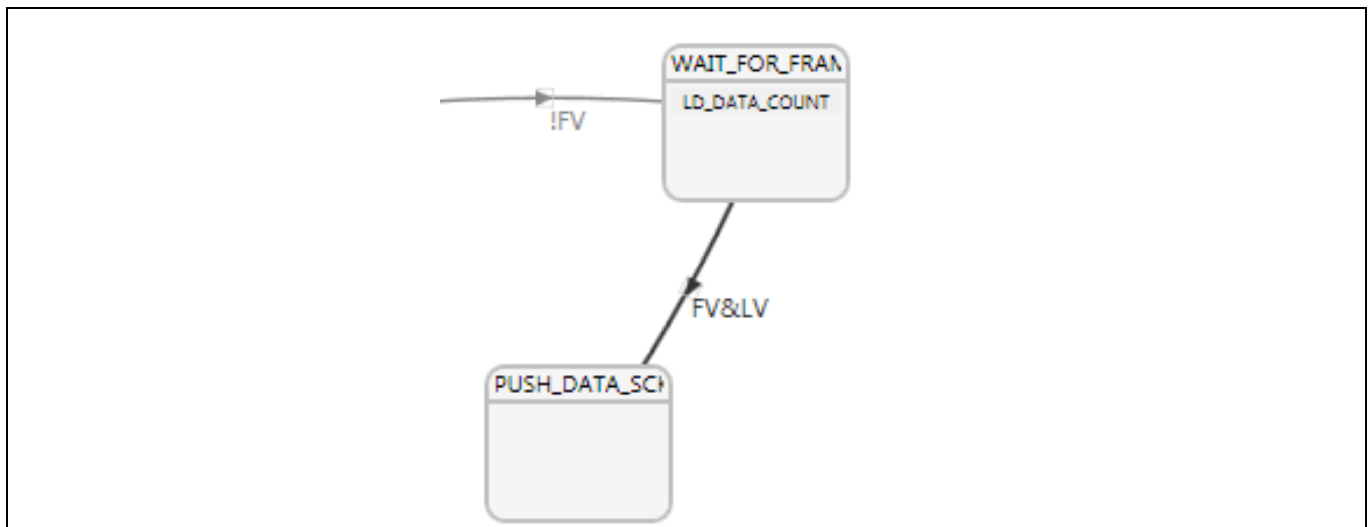

**Figure 29** PUSH\_DATA\_SCK0 and its transition condition FV&LV

11. Add the COUNT\_DATA action to the PUSH\_DATA\_SCK0 state. This increments the DATA (Socket 0) counter value on every PCLK rising edge.
12. Add the IN\_DATA action to the PUSH\_DATA\_SCK0 state. This action reads data from the data bus into the DMA buffers.
13. Add the LD\_ADDR\_COUNT action to the PUSH\_DATA\_SCK0 state to reload the ADDR counter. As before, the counter load is done in the state that actually increments the counter. The ADDR counter counts the bytes transferred into SCK1.
14. Edit the properties of the action IN\_DATA in the PUSH\_DATA\_SCK0 state, as **Figure 30** shows.

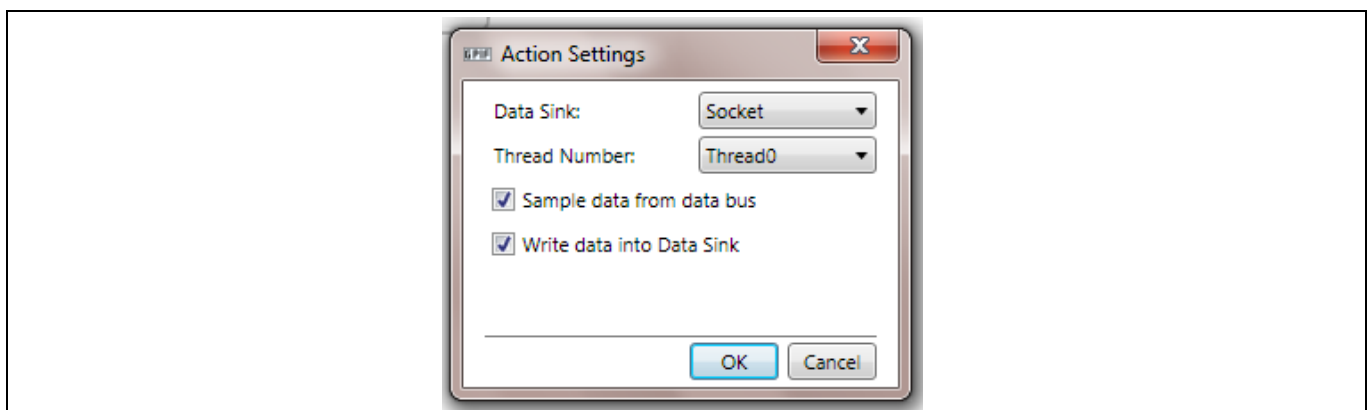

**Figure 30** PUSH\_DATA\_SCK0 action settings

15. Add a new state with the name PUSH\_DATA\_SCK1. Create a transition from the WAIT\_FOR\_FRAME\_START\_1 state to the PUSH\_DATA\_SCK1 state and edit this transition equation entry to occur when FV and LV are both asserted. Add the COUNT\_ADDR, IN\_DATA and LD\_DATA\_COUNT actions to PUSH\_DATA\_SCK1state.
16. Edit the properties of the IN\_DATA action in the PUSH\_DATA\_SCK1 state to use Thread1, as shown in **Figure 31**.

# How to implement an image sensor interface using EZ-USB™ FX3 in a USB Video Class (UVC) framework



## GPIF II image sensor interface

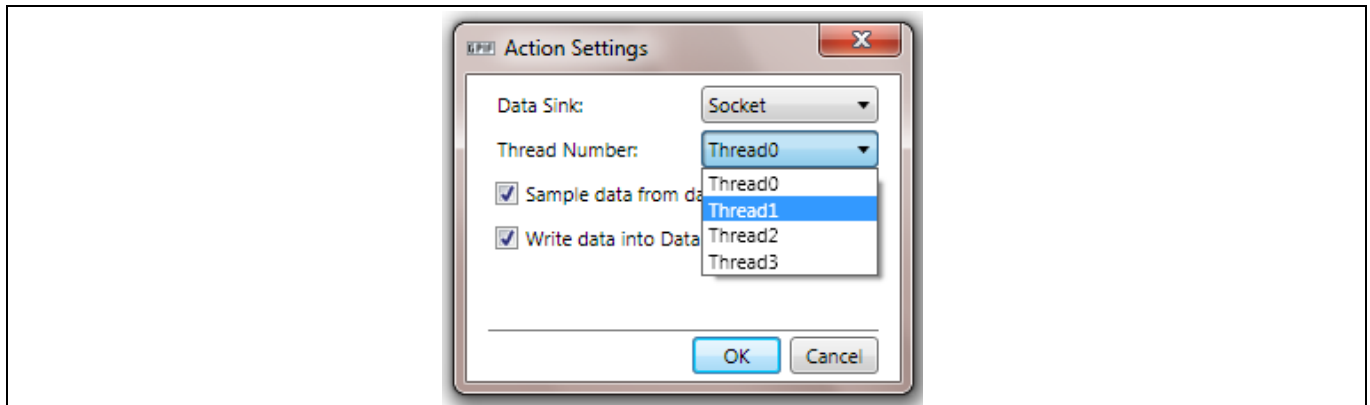

**Figure 31** PUSH\_DATA\_SCK1 IN\_DATA action

- 17. Create a transition from the PUSH\_DATA\_SCK0 state to the PUSH\_DATA\_SCK1 state. Edit this transition's equation entry using the equation "LV and DATA\_CNT\_HIT".
- 18. Create a transition from the PUSH\_DATA\_SCK1 state to the PUSH\_DATA\_SCK0 state. Reverse direction. Edit this transition's equation entry with the equation "LV and ADDR\_CNT\_HIT".

These transitions define state transitions that switch between GPIF threads during an active line at the DMA buffer boundaries. **Figure 32** shows this portion of the state machine.

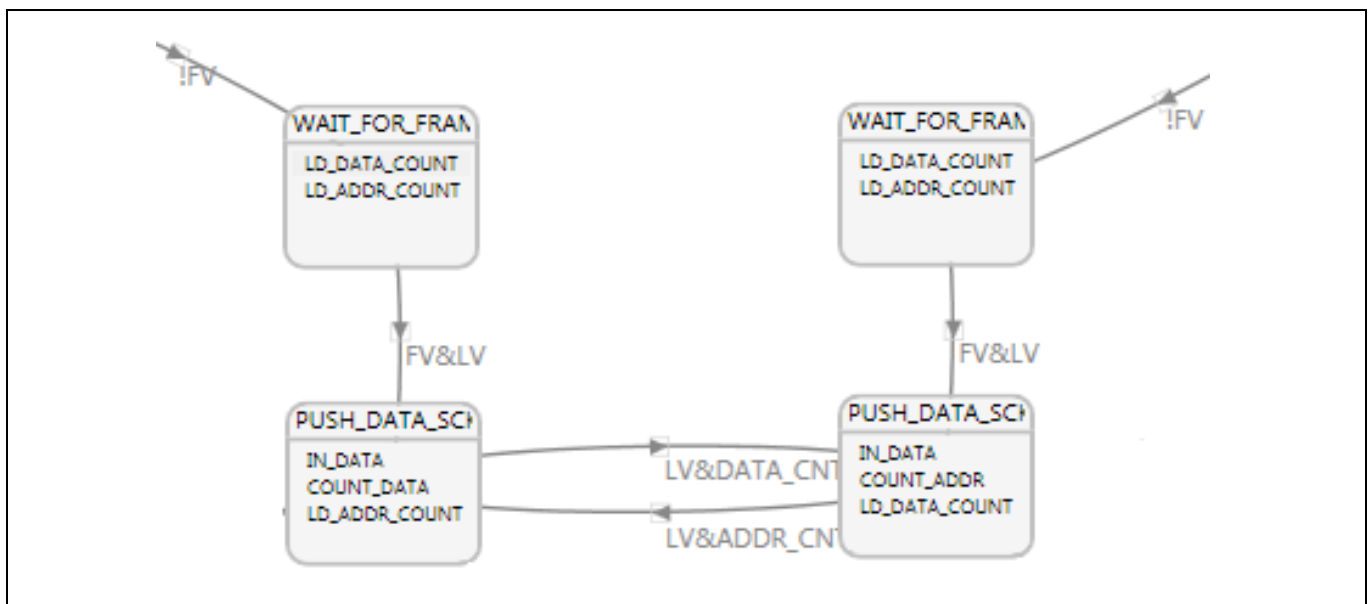

**Figure 32** The ping-pong action from Figure 11

- 19. Add a new state "LINE\_END\_SCK0" to the left of the PUSH\_DATA\_SCK0 state.
- 20. Add a new state "LINE\_END\_SCK1" to the right of the PUSH\_DATA\_SCK1 state.

These two states are entered when the LV signal is deasserted while the image sensor switches to the next video line. Because the same operation is alternately executed using different GPIF threads, the states are required on both socket0 and socket1 sides.

- 21. The PUSH\_DATA state requires three possible exit transitions, but the GPIF II hardware implements a maximum of two per state. The three-transition requirement is handled by creating a dummy state that

# How to implement an image sensor interface using EZ-USB™ FX3 in a USB Video Class (UVC) framework



## GPIF II image sensor interface

does nothing but distribute three exit conditions between two states. To demonstrate this, **Figure 33** shows a state A transitioning to states B, C, or D based on conditions 1, 2, or 3.

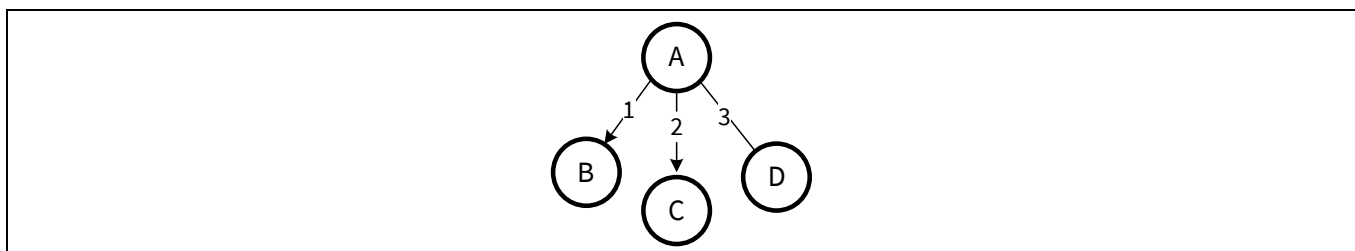

**Figure 33** State A requires exit conditions 1, 2, and 3

22. To make this GPIF II compatible, add the dummy state A2, as shown in **Figure 34**.

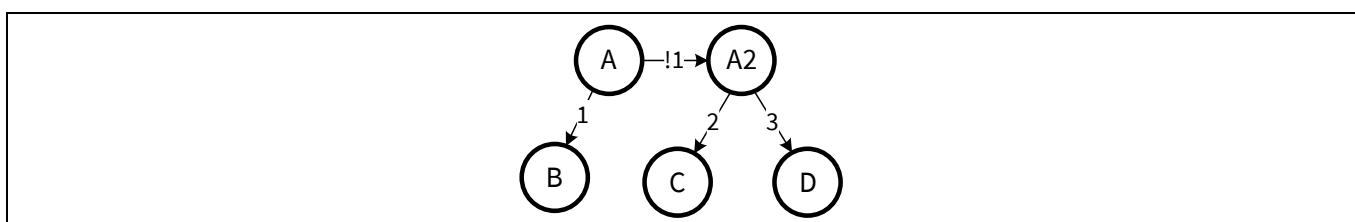
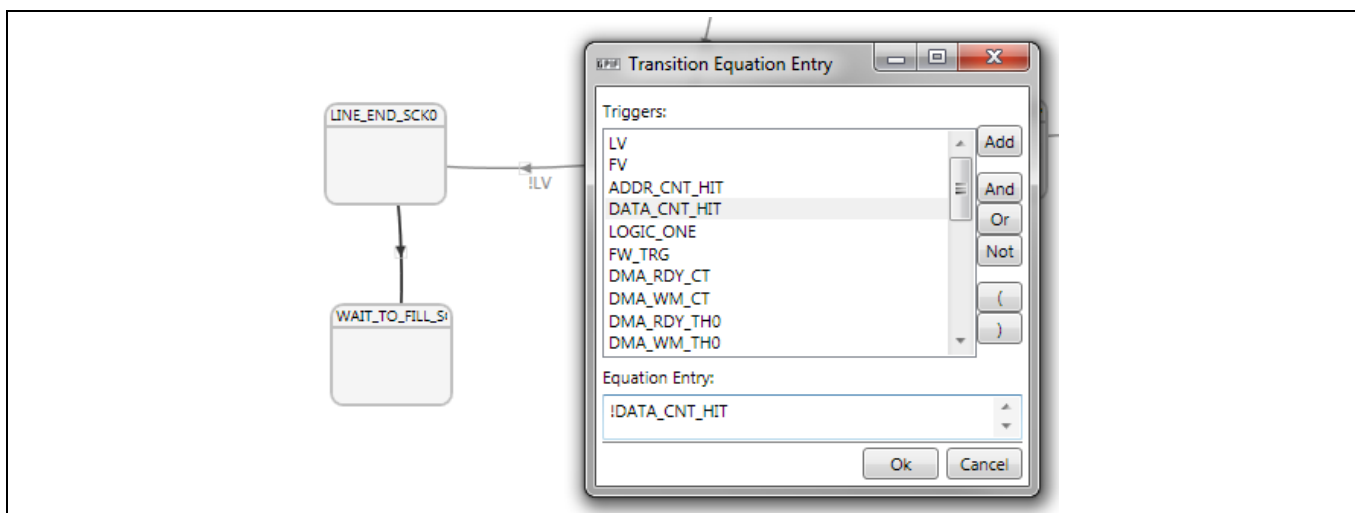

**Figure 34** Add a dummy state A2 for GPIF II compatibility

- 23. Create the LINE\_END state to serve as this dummy state.
- 24. Create a transition from the PUSH\_DATA\_SCK0 state to the LINE\_END\_SCK0 state with the transition equation “(not LV)”.
- 25. Create a transition from the PUSH\_DATA\_SCK1 state to the LINE\_END\_SCK1 state with the transition equation “(not LV)”.
- 26. Add a new state “WAIT\_TO\_FILL\_SCK0” below the LINE\_END\_SCK0 state.
- 27. Add a new state “WAIT\_TO\_FILL\_SCK1” below the LINE\_END\_SCK1 state.

These two states are entered when the DMA buffers are not full but the line valid is deasserted.

- 28. Create a transition from the LINE\_END\_SCK0 state to the WAIT\_TO\_FILL\_SCK0 state with the transition equation “(not DATA\_CNT\_HIT)”, as **Figure 35** shows.

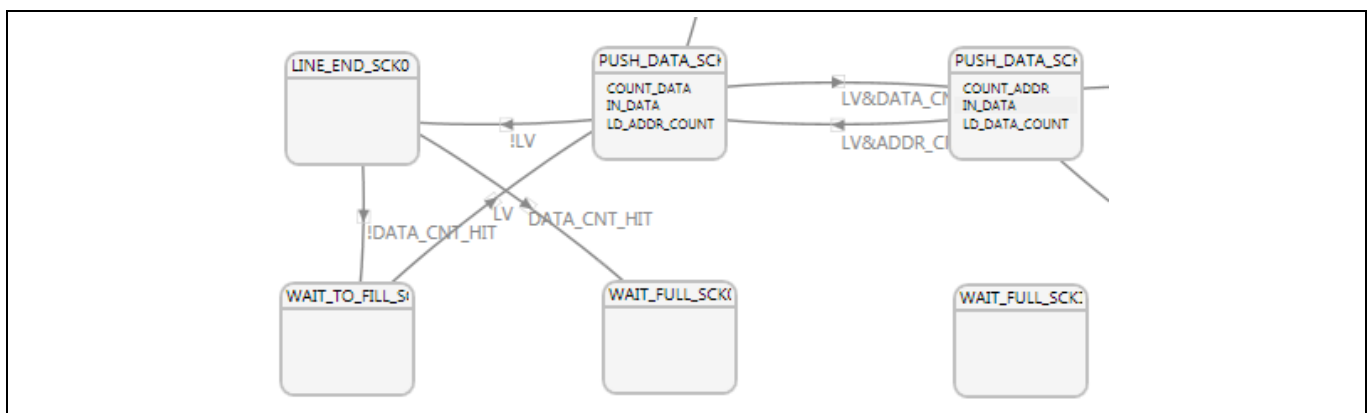

**Figure 35** DATA\_CNT\_HIT indicates the counter has reached its programmed limit

# How to implement an image sensor interface using EZ-USB™ FX3 in a USB Video Class (UVC) framework

## GPIF II image sensor interface

29. Create a transition back from the “WAIT\_TO\_FILL\_SCK0” state to the “PUSH\_DATA\_SCK0” state with the equation “LV”. The data transfer resumes in the same socket as soon as the line is active.
30. Create a transition from the “LINE\_END\_SCK1” state to the “WAIT\_TO\_FILL\_SCK1” state with the transition equation “(not ADDR\_CNT\_HIT)”.
31. Create a transition back from the “WAIT\_TO\_FILL\_SCK1” state to the “PUSH\_DATA\_SCK1” state with the equation “LV”.
32. Add a new state “WAIT\_FULL\_SCK0\_NEXT\_SCK1” below the “PUSH\_DATA\_SCK0” state.
33. Add a new state “WAIT\_FULL\_SCK1\_NEXT\_SCK0” below the “PUSH\_DATA\_SCK1” state.
34. During these two states (WAIT\_FULL\_), the image sensor is switching lines at the DMA buffer boundaries. Therefore, the next byte transfer must use the currently inactive GPIF thread.
35. Create a transition from the “LINE\_END\_SCK0” state to the “WAIT\_FULL\_SCK0\_NEXT\_SCK1” state with the equation “DATA\_CNT\_HIT”. This portion of the state machine appears as shown in **Figure 36**.



**Figure 36** WAIT\_FULL states added

36. Create a transition from the “LINE\_END\_SCK1” state to the “WAIT\_FULL\_SCK1\_NEXT\_SCK0” state with the equation “ADDR\_CNT\_HIT”.
37. Create a transition from the “WAIT\_FULL\_SCK0\_NEXT\_SCK1” state to the “PUSH\_DATA\_SCK1” state with the equation “LV”. Notice that doing so creates a crossed link in the diagram.
38. Create a transition from the “WAIT\_FULL\_SCK1\_NEXT\_SCK0” state to the “PUSH\_DATA\_SCK0” state with the equation “LV”. The resultant state machine portion appears as in **Figure 37**.

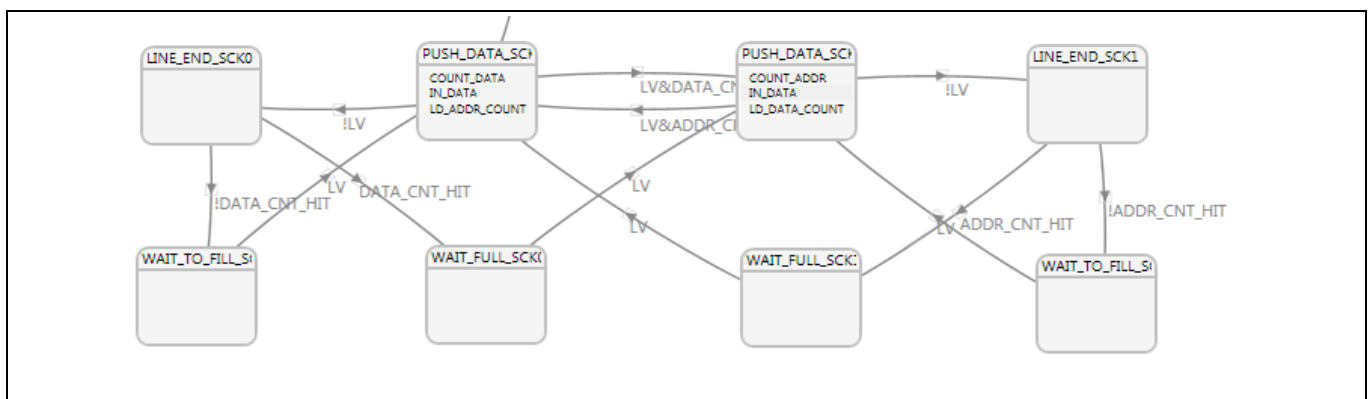

**Figure 37** Wait when DMA buffers are full

39. Add a new state “PARTIAL\_BUF\_IN\_SCK0” below the “WAIT\_TO\_FILL\_SCK0” state.
40. Add a new state “PARTIAL\_BUF\_IN\_SCK1” below the “WAIT\_TO\_FILL\_SCK1” state.

# How to implement an image sensor interface using EZ-USB™ FX3 in a USB Video Class (UVC) framework



## GPIF II image sensor interface

The PARTIAL\_BUF\_ states are an indication of the end of the frame, where the last DMA buffer has not completely filled. The CPU must commit this partial DMA buffer manually when it responds to a GPIF II-generated interrupt request.

41. Add a new state “FULL\_BUF\_IN\_SCK0” below the “WAIT\_FULL\_SCK0\_NEXT\_SCK1” state.
42. Add a new state “FULL\_BUF\_IN\_SCK1” below the “WAIT\_FULL\_SCK1\_NEXT\_SCK0” state.

The FULL\_BUF\_ states are an indication that the end of the frame data is the last byte in the DMA buffer associated with the corresponding GPIF thread. The GPIF II hardware has taken care of committing this full DMA buffer, so any further action here would be application-specific.

43. Create a transition from the “WAIT\_TO\_FILL\_SCK0” state to the “PARTIAL\_BUF\_IN\_SCK0” state with the equation “not FV”.
44. Create a transition from the “WAIT\_TO\_FILL\_SCK1” state to the “PARTIAL\_BUF\_IN\_SCK1” state with the equation “not FV”.
45. Create a transition from the “WAIT\_FULL\_SCK0\_NEXT\_SCK1” state to the “FULL\_BUF\_IN\_SCK0” state with the equation “not FV”.
46. Create a transition from the “WAIT\_FULL\_SCK1\_NEXT\_SCK0” state to the “FULL\_BUF\_IN\_SCK1” state with the equation “not FV”.
47. Add action “Intr\_CPU” in each of the states “PARTIAL\_BUF\_IN\_SCK0”, “PARTIAL\_BUF\_IN\_SCK1”, “FULL\_BUF\_IN\_SCK0”, and “FULL\_BUF\_IN\_SCK1”.
48. Add a new state “FRAME\_END\_SCK\_0” and add transitions from states “PARTIAL\_BUF\_IN\_SCK0” and “FULL\_BUF\_IN\_SCK0” with the transition condition as “firmware trigger asserted (FW\_TRIG)”, and then add a transition from “FRAME\_END\_SCK\_0” to the state “IDLE\_1” with the transition condition as “firmware trigger de-asserted (!FW\_TRIG)”.
49. Similar to the previous step, create the state “FRAME\_END\_SCK\_1” and add transitions from states “PARTIAL\_BUF\_IN\_SCK1” and “FULL\_BUF\_IN\_SCK1” with the transition condition as “firmware trigger asserted (FW\_TRIG)” and then add a transition from “FRAME\_END\_SCK\_1” to the state “IDLE\_0” with the transition condition as “firmware trigger de-asserted (!FW\_TRIG)”.

The final state machine appears as [Figure 39](#). This can be compared with [Figure 13](#), with the only difference being the addition of the PUSH\_DATA states to accommodate the two-transition maximum for any state.

50. Save the project by selecting “File-Save Project As”.
51. Build the project using the Build icon highlighted in [Figure 38](#). The project output window indicates the build status.

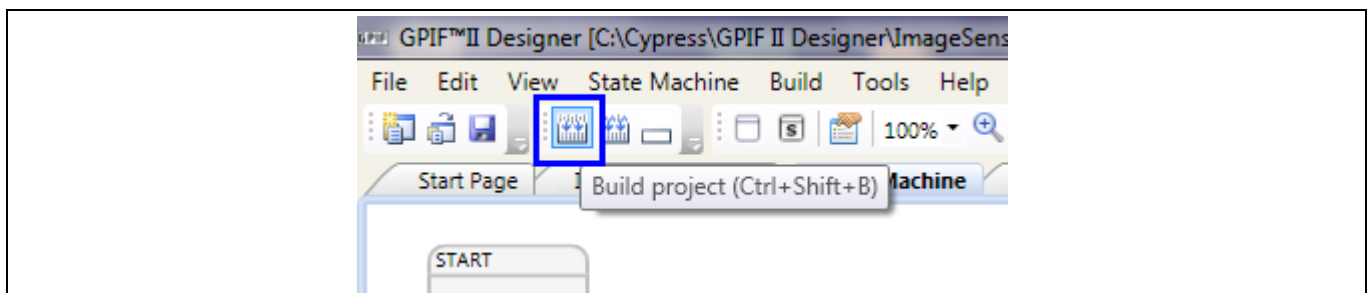

**Figure 38** The BUILD button



# How to implement an image sensor interface using EZ-USB™ FX3 in a USB Video Class (UVC) framework

## GPIF II image sensor interface

52. Check the output of the project. This appears as a header file called *cyfxgpi2config.h* in the project directory. If you examine this header file, you'll see that GPIF II designer II has created arrays of GPIF II internal settings that will be used by the EZ-USB™ FX3 firmware to configure the GPIF II and to define its state machine. Never directly edit this file; let GPIF II designer do the work for you.

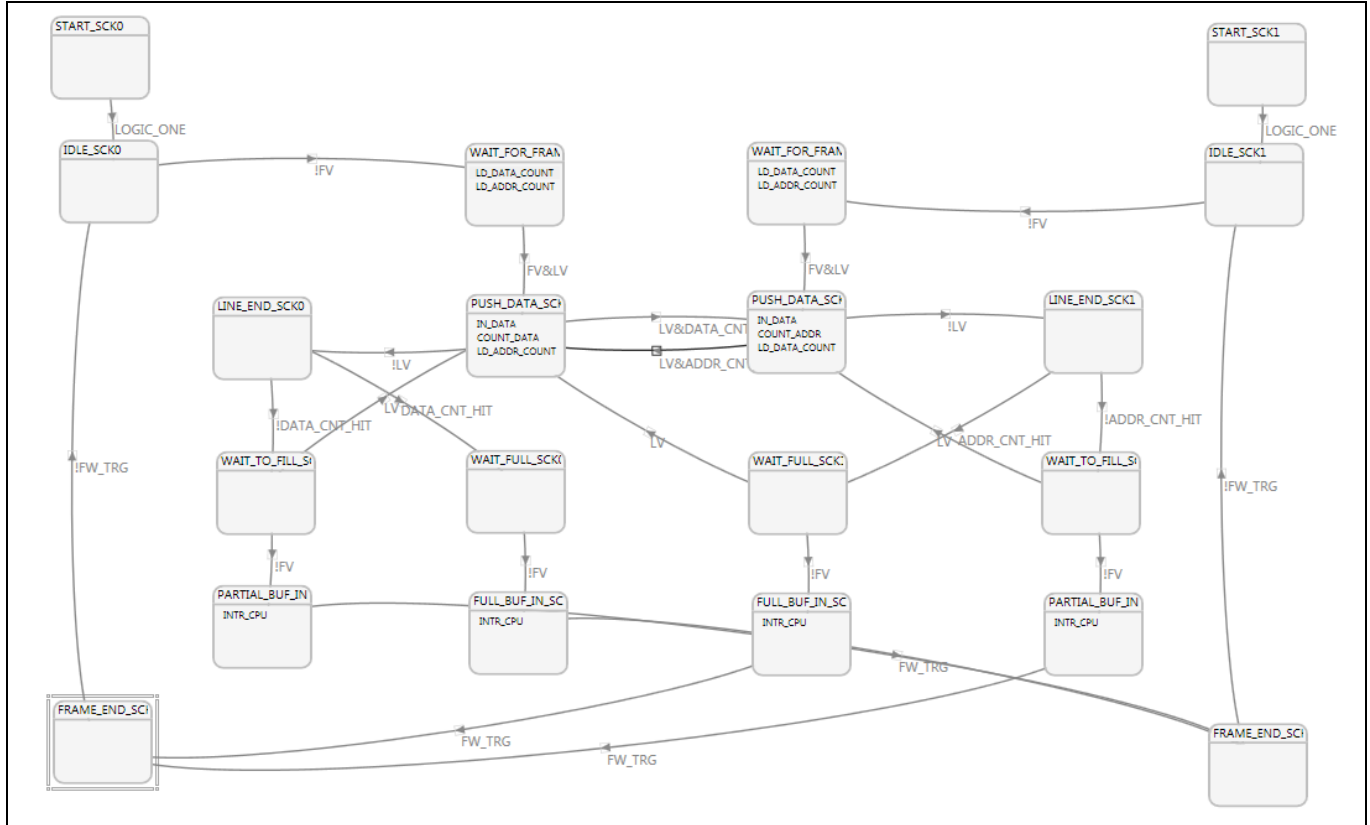

**Figure 39 Final state machine diagram**

### 3.6.5 Editing GPIF II interface details

This section describes how to change the interface settings, if required. As an example, if the image sensor/ASIC has a 16-bit-wide data bus, you would need to change the GPIF II interface to accommodate the data bus. To accomplish this, take the following steps:

1. Open the **ImageSensorInterface.cyfx** project in the GPIF II designer. (This project may not be directly compiled.)
2. Go to File->Save Project As.
3. Save the project in a convenient location with a convenient name in the dialog box that will appear.
4. Close the currently open project (File->Close Project).
5. Open the project that was saved in Step 3.
6. Go to the **Interface Definition** tab and choose the **16 Bit** option for **Address/Data Bus Usage** setting.
7. Go to the **State Machine** tab.
8. In the state machine canvas, double-click the LD\_DATA\_COUNT action inside the WAIT\_FOR\_FRAME\_START state. Change the counter limit value to 8183.
9. Do the same for LD\_ADDR\_COUNT action.
10. Save the Project.
11. Build the Project.

# How to implement an image sensor interface using EZ-USB™ FX3 in a USB Video Class (UVC) framework

---



## GPIF II image sensor interface

12. Copy the newly generated *cyfxgpif2config.h* header file from the location selected in Step 3 to the firmware project directory. You will overwrite the existing *cyfxgpif2config.h* file if there is one. Find the firmware project directory, *cyfxuvc\_an75779*, inside the zip file of the attached source.

*Note: If you are changing the GPIF II bus width to 32 bits, make sure the iomatrix configuration in the firmware has the isDQ32Bit parameter set to CyTrue.*

The next sections explain the details of the DMA channel to stream data and the firmware that supports UVC.

## Setting up the DMA system

### 4 Setting up the DMA system

The GPIF II block, a part of the processor interface block (PIB), can run up to 100 MHz with 32 bits of data (400-MBps). To transfer the data into internal DMA buffers, GPIF II uses multiple GPIF threads connected to DMA producer sockets (explained in [Section 3.3](#)). Two of the four GPIF threads are used in this application. Default mapping ([Figure 40](#)) of the sockets and GPIF threads is used for this application—Socket 0 is connected to GPIF thread 0, and Socket 1 is connected to GPIF thread 1. The GPIF thread switching is accomplished in the GPIF II state machine designed in the previous section.

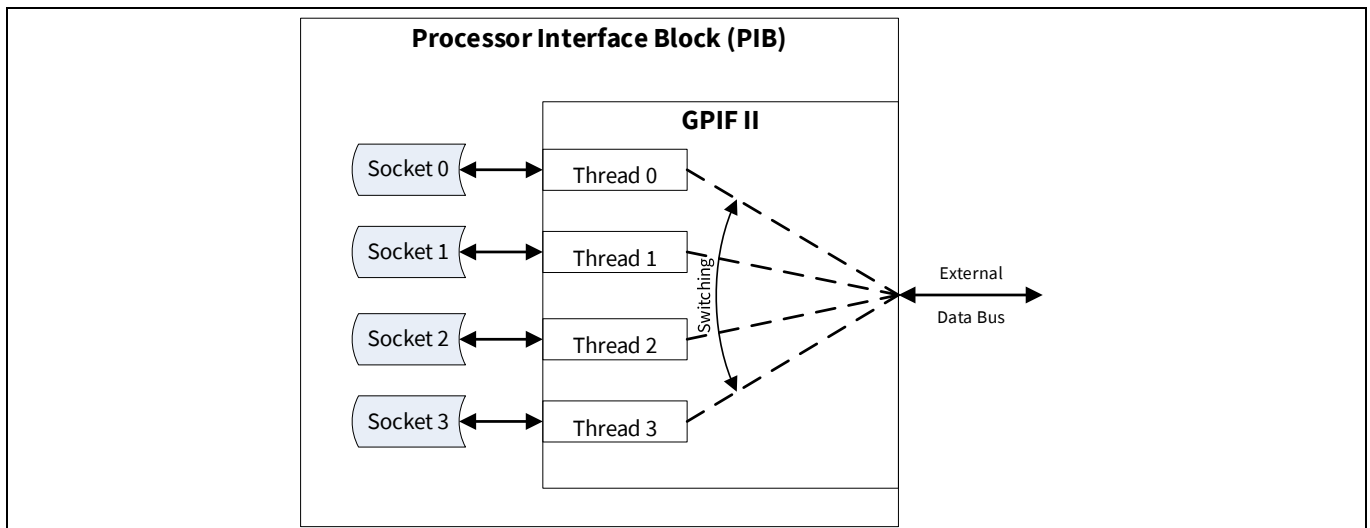

**Figure 40** Default GPIF II socket/thread mapping

To understand DMA transfers, the concept of a socket is further explored in the following four figures. [Figure 41](#) shows the two main socket attributes, a linked list, and a data router.

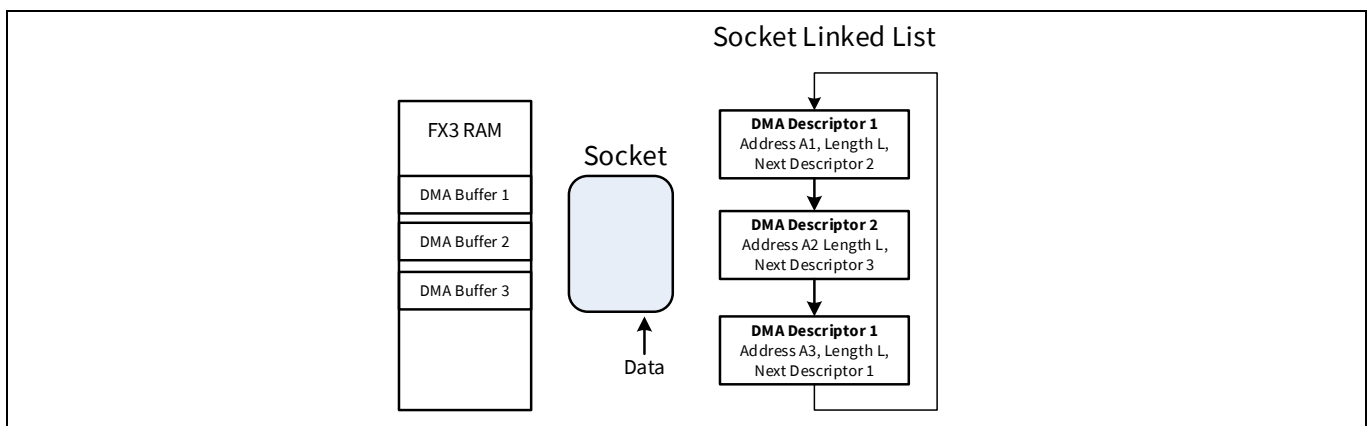

**Figure 41** A Socket routes data according to a list of DMA descriptors

The socket linked list is a set of data structures in main memory called DMA descriptors. Each descriptor specifies a DMA buffer address and length as well as a pointer to the next DMA descriptor. As the socket operates, it retrieves the DMA descriptors one at a time, routing the data to the DMA buffer specified by the descriptor address and length. When L bytes have transferred, the socket retrieves the next descriptor and continues transferring bytes to a different DMA buffer.

# How to implement an image sensor interface using EZ-USB™ FX3 in a USB Video Class (UVC) framework

## Setting up the DMA system

This structure makes a socket extremely versatile because any number of DMA buffers can be created anywhere in memory and be automatically chained together. For example, the socket in **Figure 41** retrieves DMA descriptors in a repeating loop.

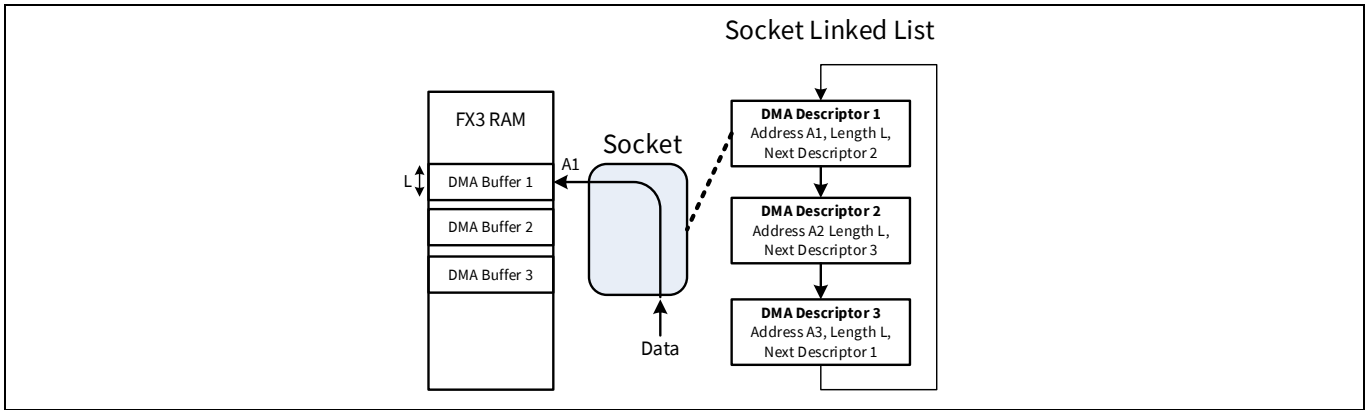

**Figure 42** A socket operating with DMA descriptor 1

In **Figure 42**, the socket has loaded DMA descriptor 1, which tells it to transfer bytes starting at A1 until it has transferred L bytes, at which time it retrieves DMA descriptor 2 and continues with its address and length settings A2 and L (**Figure 43**).

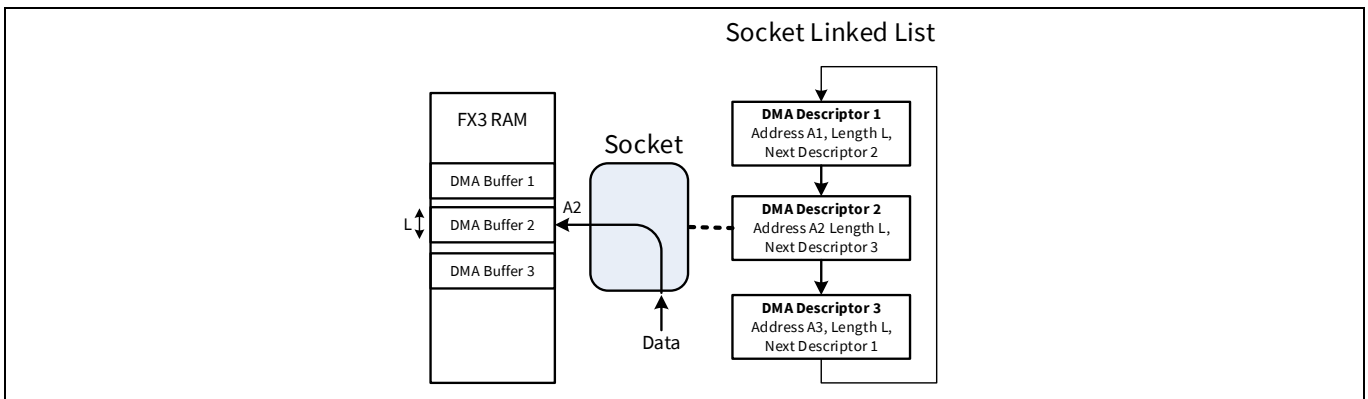

**Figure 43** A socket operating with DMA descriptor 2

In **Figure 44** the socket retrieves the third DMA descriptor and transfers data starting at A3. When it has transferred L bytes, the sequence repeats with DMA descriptor 1.

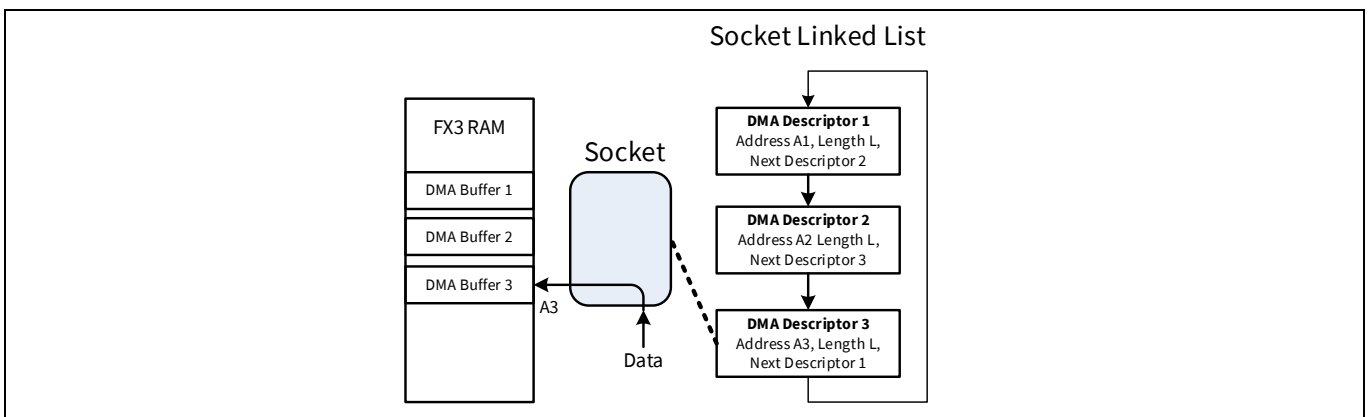

**Figure 44** A socket operating with DMA descriptor 3

# How to implement an image sensor interface using EZ-USB™ FX3 in a USB Video Class (UVC) framework



## Setting up the DMA system

**Figure 45** shows a DMA data transfer in more detail. This example uses three DMA buffers of length L chained in a circular loop. EZ-USB™ FX3 memory addresses are on the left. The blue arrows show the socket loading the socket linked list descriptors from memory. The red arrows show the resulting data paths. The following steps show the socket sequence as data is moved to the internal DMA buffers.

Step 1: Load DMA descriptor 1 from the memory into the socket. Get the DMA buffer location (A1), DMA buffer size (L), and next descriptor (DMA descriptor 2) information. Go to Step 2.

Step 2: Transfer data to the DMA buffer location starting at A1. After transferring DMA buffer size L amount of data, go to Step 3.

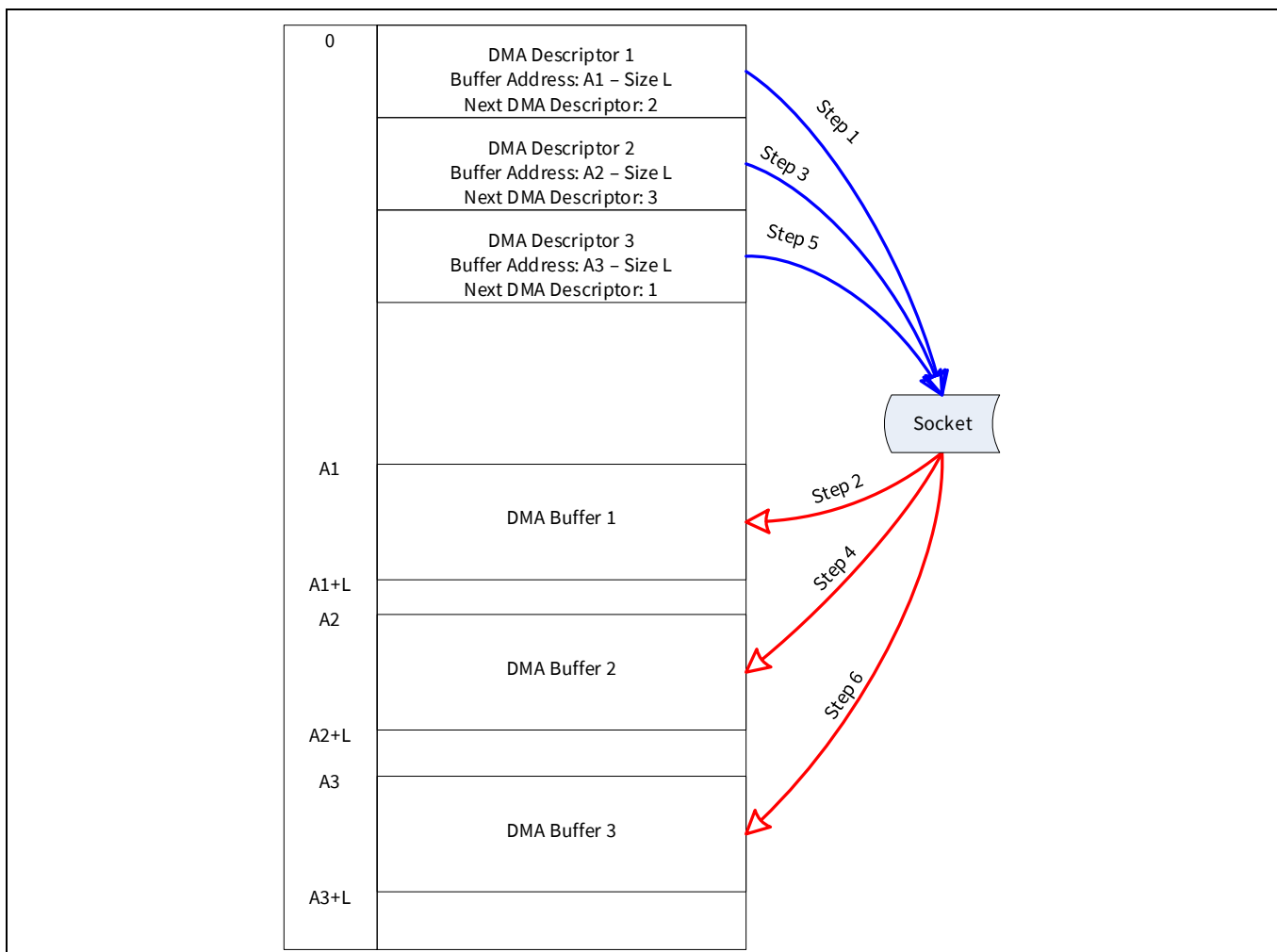

**Figure 45 DMA transfer example**

Step 3: Load DMA descriptor 2 as pointed to by the current DMA descriptor 1. Get the DMA buffer location (A2), DMA buffer size (L), and next descriptor (DMA descriptor 3) information. Go to Step 4.

Step 4: Transfer data to the DMA buffer location starting at A2. After transferring DMA buffer size L amount of data, go to Step 5.

Step 5: Load DMA descriptor 3 as pointed to by the current DMA descriptor 2. Get the DMA buffer location (A3), DMA buffer size (L), and next descriptor (DMA descriptor 1) information. Go to Step 6.

Step 6: Transfer data to the DMA buffer location starting at A3. After transferring DMA buffer size L amount of data, go to Step 1.

# How to implement an image sensor interface using EZ-USB™ FX3 in a USB Video Class (UVC) framework



## Setting up the DMA system

This simple scheme has an issue in the camera application. A socket takes time to retrieve the next DMA descriptor from memory, typically 1 microsecond. If this transfer pause occurs in the middle of a video line, the video data is lost. To prevent this loss, the DMA buffer size can be set as a multiple of the video line length. This would make the DMA buffer switching pause coincide with the time that the video line is inactive (LV=0). However, this approach lacks flexibility if, for example, the video resolution is changed.

Setting DMA buffer size exactly equal to line size is also not a good solution because it does not take advantage of the USB 3.0 maximum burst rate for BULK transfers. USB 3.0 allows a maximum of 16 bursts of 1024 bytes over BULK endpoints. This is why the DMA buffer size is set to 16 KB.

A better solution is to take advantage of the fact that sockets can be switched without latency—in one clock cycle. Therefore, it makes sense to use *two* sockets to store data into four interleaved DMA buffers. Data transfer using dual sockets is described in **Figure 46**, again with numbered execution steps. Socket0 and socket1 access to DMA buffers is differentiated by red and green arrows (data paths for individual sockets), respectively. The ‘a’ and ‘b’ parts of each step occur simultaneously. This parallel operation of the hardware eliminates DMA descriptor retrieval dead time and allows the GPIF II to stream data continuously into internal memory. These steps correspond to the “Step” line in **Figure 14**.

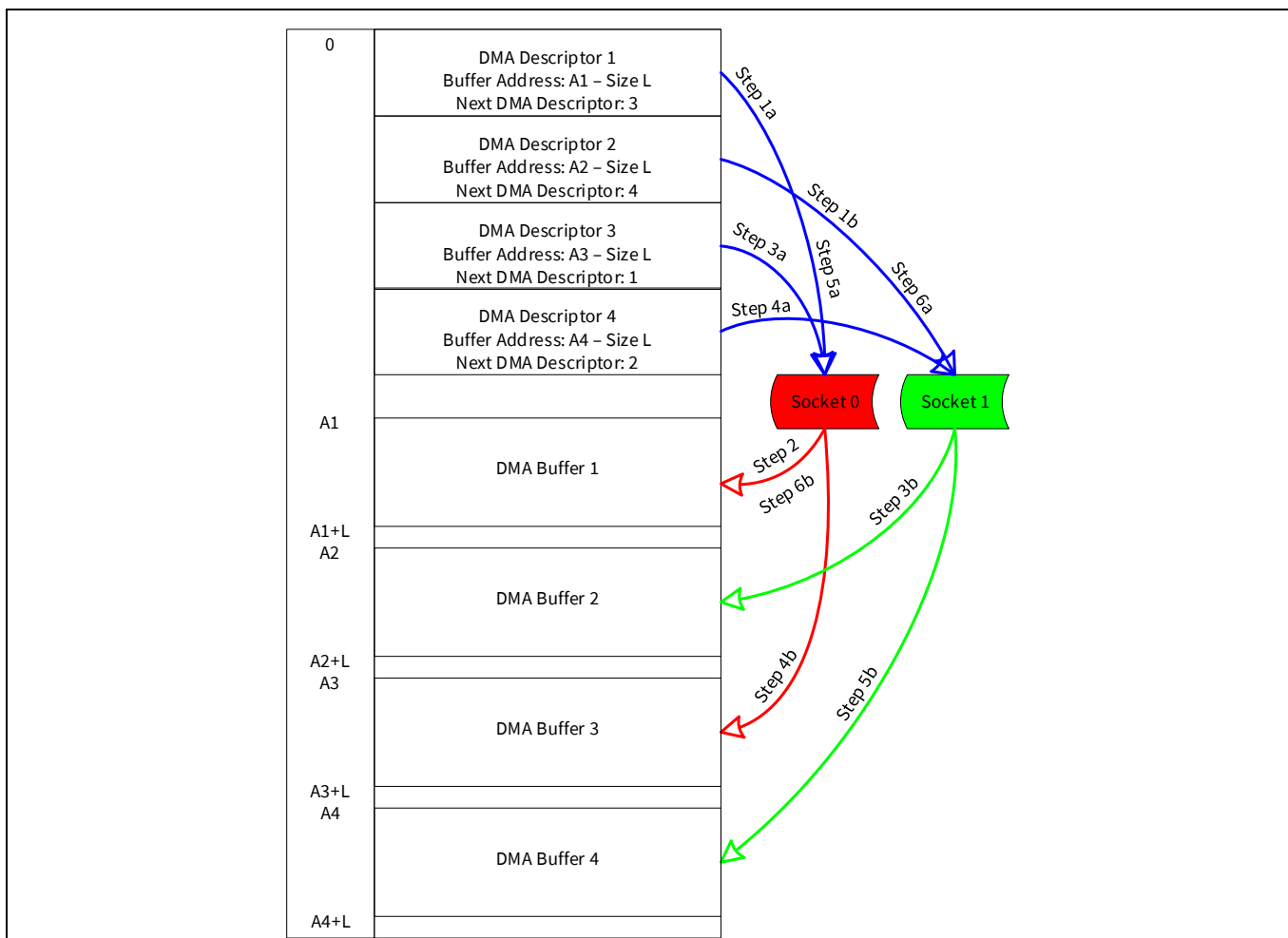

**Figure 46 Dual sockets yield seamless transfers**

Step 1: At initialization of the sockets, socket 0 and socket 1 load the DMA descriptor 1 and DMA descriptor 2, respectively.

# How to implement an image sensor interface using EZ-USB™ FX3 in a USB Video Class (UVC) framework



## Setting up the DMA system

Step 2: As soon as the data is available, socket 0 transfers the data to DMA buffer 1. The transfer length is L. At the end of this transfer, go to step 3.

Step 3: GPIF II switches the GPIF thread and, therefore, the socket for data transfer. Socket 1 starts to transfer data to DMA buffer 2, and, at the same time, socket 0 loads the DMA descriptor 3. By the time socket 1 finishes transferring L amount of data, socket 0 is ready to transfer data into DMA buffer 3.

Step 4: GPIF II now switches back to the original GPIF thread. Socket 0 now transfers the data of length L into DMA buffer 3. At the same time, socket 1 loads the DMA descriptor 4, making it ready to transfer data to DMA buffer 4. After Socket 0 finishes transferring the data of length L, go to Step 5.

Step 5: GPIF II routes socket 1 data into DMA buffer 4. At the same time, socket 0 loads DMA descriptor 1 to prepare to transfer data into DMA buffer 1. Notice that Step 5a is the same as Step 1a except that socket 1 is not initializing but, rather, transferring data simultaneously.

Step 6: GPIF II switches sockets again, and Socket 0 starts to transfer data of length L into DMA buffer 1. It is assumed that by now, the DMA buffer is empty, having been depleted by the USB consumer socket. At the same time, Socket 1 loads the DMA descriptor 2 and is ready to transfer data into DMA buffer 2. The cycle now goes to Step 3 in the execution path.

GPIF II sockets can transfer video data only if the consuming side (USB) empties and releases the DMA buffers in time to receive the next chunk of video data from GPIF II. If the consumer is not fast enough, the sockets drop data because their DMA buffer writes are ignored. As a result, the byte counters lose sync with the actual transfers, which can propagate to the next frame. Therefore, a cleanup mechanism is required at the end of every frame. This mechanism is described in the [Clean Up](#) section.

According to the flowchart in [Figure 13](#), a frame transfer ends with four possible states:

- Socket 0 has transferred a full DMA buffer
- Socket 1 has transferred a full DMA buffer
- Socket 0 has transferred a partial DMA buffer
- Socket 1 has transferred a partial DMA buffer

In the partial DMA buffer cases, the CPU needs to commit the partial DMA buffer to the USB consumer.

The DMA channel is initialized using a function in the *uvc.c* file called **CyFxDMAChannelInit**. The DMA channel configuration details are customized in the “dmaMultiConfig” structure in the **CyFxDMAChannelInit** function. The DMA channel type is set to MANUAL\_MANY\_TO\_ONE.

In addition, the USB endpoint that streams data to the USB 3.0 host is configured to enable a burst of 16 over the 1024-byte BULK endpoint. This is set using the “endPointConfig” structure passed in the “CyU3PSetEpConfig” function, with the endpoint constant set to “CY\_FX\_EP\_BULK\_VIDEO”.

## 4.1 About DMA buffers

This section summarizes how EZ-USB™ FX3 DMA buffers are created and used in this application.

- The integral parts of a DMA channel are described in [Section 3.3](#).
- In this application, the GPIF II unit is the producer, and the EZ-USB™ FX3 USB unit is the consumer.
- This application uses the GPIF thread switching feature in the GPIF II block to avoid data drops.
- When a producer socket loads a DMA descriptor, it checks the associated DMA buffer to see if it is ready for a write operation. The producer socket changes its state to “active” for writing data into EZ-USB™ FX3 RAM if it finds that the DMA buffer is empty. The producer socket locks the DMA buffer for write operations.

# How to implement an image sensor interface using EZ-USB™ FX3 in a USB Video Class (UVC) framework



## Setting up the DMA system

- When a producer socket is finished writing to a DMA buffer, it releases the lock so that the consumer socket can access the DMA buffer. The action is called “buffer wrap-up“ or simply “wrap-up”. The DMA unit is then said to commit the DMA buffer to the EZ-USB™ FX3 RAM. The producer socket is said to have produced a DMA buffer. A DMA buffer should be wrapped up only while the producer is not actively filling it. This is the reason for the FV=0 test in the state diagrams.
- If a DMA buffer fills completely, as it does repeatedly during a frame, the wrap-up operation is automatic. The producer socket releases the lock on the DMA buffer, commits it to the EZ-USB™ FX3 RAM, switches to an empty DMA buffer, and continues to write the video data stream.
- When a consumer socket loads a DMA descriptor, it checks the associated DMA buffer to see if it is ready for a read operation. The consumer socket changes its state to “active” for reading data from EZ-USB™ FX3 RAM if it finds that the DMA buffer is committed. The consumer socket locks the DMA buffer for read operations.
- After the consumer socket has read all the data from the DMA buffer, it releases the lock so that the producer socket can access the DMA buffer. The consumer socket is said to have consumed the DMA buffer.
- If the same DMA descriptors are used by the producer and consumer sockets, the DMA buffer full/empty status is communicated automatically between the producer and consumer sockets via the DMA descriptors and inter-socket events.
- In this application, because the CPU needs to add a 12-byte UVC header, the producer socket and the consumer socket need to load different sets of DMA descriptors. The DMA descriptors loaded by the producer socket will point to DMA buffers that are at a 12-byte offset from the corresponding DMA buffers that the DMA descriptors loaded by the consumer socket point to.
- Due to different DMA descriptors for producer and consumer sockets, the CPU must manage the communication of the DMA buffer status between the producer and the consumer sockets. This is why the DMA channel implementation is called a “Manual DMA” channel.
- After a DMA buffer is produced by the GPIF II block, the CPU is notified via an interrupt. The CPU then adds the header information and commits the DMA buffer to the consumer (USB Interface Block).
- On the GPIF II side, the video data in DMA buffers are automatically wrapped up and committed to the EZ-USB™ FX3 RAM for all but the last DMA buffer in the frame. No CPU intervention is required.
- At the end of a frame, the final DMA buffer is likely not filled completely. In this case, the CPU intervenes and manually wraps up the DMA buffer and commits it to the EZ-USB™ FX3 RAM. This is called a “forced wrap-up”.



# How to implement an image sensor interface using EZ-USB™ FX3 in a USB Video Class (UVC) framework



## EZ-USB™ FX3 firmware

### 5 EZ-USB™ FX3 firmware

The example firmware supplied with this application note is located under the *cyfxuvc\_an75779* folder of the zip file of the source. See [AN75705 - Getting started with EZ-USB™ FX3](#), to import the firmware project in the Eclipse workspace. This example firmware will compile and enumerate, but the user must tailor it to a particular image sensor using the *sensor.c* and *sensor.h* files to be able to stream video from the image sensor.

If the ON Semiconductor (Aptina) sensor board is used as described in [Section 6](#) of this application note, Infineon provided *sensor.c* and *sensor.h* files correspond with this particular sensor. A pre-compiled load image is provided in the project to try out the EZ-USB™ FX3 - ON Semiconductor sensor configuration ([Section 7](#)). [Table 8](#) summarizes the code modules and the functions implemented in each module.

**Table 8 Example project files**

File	Description
<i>sensor.c</i>	Defines SensorWrite2B, SensorWrite, SensorRead2B, and SensorRead functions to write and read the image sensor configuration over I <sup>2</sup> C. These functions assume that the register addresses on the I <sup>2</sup> C bus of the image sensor are 16-bit wide. Defines SensorReset function to control the reset line of the image sensor, and SensorInit function to test the I <sup>2</sup> C connection and configure the image sensor in default streaming mode (using SensorScaling_HD720p_30fps function) Defines SensorScaling_VGA and SensorScaling_HD720p_30fps functions to configure the image sensor in desired streaming modes. Defines SensorGetBrightness and SensorSetBrightness functions to read and to write the brightness value in the image sensor brightness control register.
<i>sensor.h</i>	Contains the constants used for the image sensor (its I2C slave address and reset GPIO number). You have to define the I2C slave address of the image sensor here. Contains the declarations of all the functions defined in <i>sensor.c</i>
<i>camera_ptzcontrol.c</i>	Defines the functions to read and to write the PTZ values of the camera. These are placeholder functions. They need to be populated with image sensor-specific configuration commands. Uncomment the line “#define UVC_PTZ_SUPPORT” in <i>uvc.h</i> to enable PTZ control code placeholders.
<i>camera_ptzcontrol.h</i>	Contains the constants used for the PTZ control implementation Contains the declarations of the functions defined in <i>camera_ptzcontrol.c</i> file
<i>cyfctx.c</i>	No changes needed. Use this file as provided with the project associated with this application note. It contains the variables that RTOS and the EZ-USB™ FX3 API library use for memory mapping, and functions that the FX3 API library uses for memory management.
<i>cyfxgpiif2config.h</i>	Header file generated by the GPIF II designer tool. No changes are required. If the interface needs to be changed, a new header file should be generated from the GPIF II designer tool. The new file should replace this one. Contains the structure and constants that are passed to API calls in the <i>uvc.c</i> file to start and to run the GPIF II state machine.
<i>uvc.c</i>	Main source file for UVC application. Changes are needed when modifying the code to support controls other than brightness and PTZ, and when modifying to add support for different video streaming modes. Contains the following functions:

# How to implement an image sensor interface using EZ-USB™ FX3 in a USB Video Class (UVC) framework



## EZ-USB™ FX3 firmware

File	Description
	Main: Initializes the EZ-USB™ FX3 device, sets up caches, configures the EZ-USB™ FX3 I/Os, and starts RTOS kernel
	CyFxApplicationDefine: Defines the two application threads that are executed by the RTOS
	UVCAppThread_Entry: First application thread function, calls initialization functions for internal blocks of EZ-USB™ FX3, enumerates the device, and then handles video data transfers and USB suspend event.
	UVCAppEP0Thread_Entry: Second application thread function, waits for events that indicate UVC-specific requests are received and calls corresponding functions to handle these requests
	UVCHandleProcessingUnitRqts: Handles VC requests targeted to processing unit capabilities
	UVCHandleCameraTerminalRqts: Handles VC requests targeted to input terminal capabilities
	UVCHandleExtensionUnitRqts: Handles VC requests targeted to extension unit capabilities
	UVCHandleInterfaceCtrlRqts: Handles generic VC requests not targeted to any terminal or unit
	UVCHandleVideoStreamingRqts: Handles VS requests to change streaming mode
	CyFxUVCAppInDebugInit: Initializes FX3's UART block for printing debug messages
	CyFxUVCAppInI2CInit: Initializes EZ-USB™ FX3's I2C block for image sensor configuration
	CyFxUVCAppInInit: Initializes FX3's GPIO block, processor block (GPIF II is a part of the processor block), sensor (sets configuration to 720p 30fps), USB block for enumeration, endpoint configuration memory for USB transfers and DMA channel configuration for data transfers from GPIF II to USB
	CyFxUvcAppGpifInit: initializes the GPIF II state machine and starts it
	CyFxGpifCB: Handles CPU interrupts generated from the GPIF II state machine
	CyFxUvcAppCommitEOF: Commits the partial DMA buffers produced by the GPIF II state machine to EZ-USB™ FX3 RAM
	CyFxUvcAppInDmaCallback: Keeps track of outgoing video data from EZ-USB™ FX3 to host
	CyFxUVCAppInUSBSetupCB: Handles all control requests sent by host, sets events indicating UVC-specific requests have been received from host, detects when streaming is stopped
	CyFxUVCAppInUSBEventCB: Handles USB events such as suspend, cable disconnect, reset, and resume
	CyFxUVCAppInAbortHandler: Aborts streaming video data when any error or streaming stop request is detected
	CyFxAppErrorHandler: Error handler function. This is a placeholder function for you to implement error handling if necessary
	CyFxUVCAddHeader: Adds UVC header to the video data during active streaming
	CyFxUvcAppInStop: Stops the GPIF II state machine and resets DMA and endpoint buffers.
	CyFxUvcAppInStart: Starts the DMA channel transfer and GPIF state machine.

# How to implement an image sensor interface using EZ-USB™ FX3 in a USB Video Class (UVC) framework



## EZ-USB™ FX3 firmware

File	Description
	CyFxCvAppProgressTimer: When the sensor/ISP (Image signal processor) fails to send video data in the predefined frame interval time period, resets DMA and endpoints and restarts streaming.
<i>cyfxuvcdscr.c</i>	Contains the USB enumeration descriptors for the UVC application. This file needs to be changed if the frame rate, image resolution, bit depth, or supported video controls need to be changed. The UVC specification has all the required details.
<i>uvc.h</i>	Contains switches to modify the application behavior to turn ON/OFF the PTZ support, debug interface, debug prints for frame counts, and frame timer. Contains constants that are used in common by the <i>uvc.c</i> , <i>cyfxuvcdscr.c</i> , <i>camera_ptzcontrol.c</i> , and <i>sensor.c</i> files.
<i>cyfx_gcc_startup.s</i>	This assembly source file contains the EZ-USB™ FX3 CPU startup code. It has functions that set up the stacks and interrupt vectors. No changes needed.

The firmware first initializes the EZ-USB™ FX3 CPU and configures its I/O. Then, it makes a function call (**CyU3PKernelEntry**) to start the ThreadX Real Time Operating System (RTOS). It creates two application threads: **uvcAppThread** and **uvcAppEP0Thread**. The RTOS will allocate resources to run these application threads and schedule the execution of the application thread functions: **UVCAppThread\_Entry** and **UVCAppEP0Thread\_Entry** respectively.

Figure 47 shows the basic program structure.

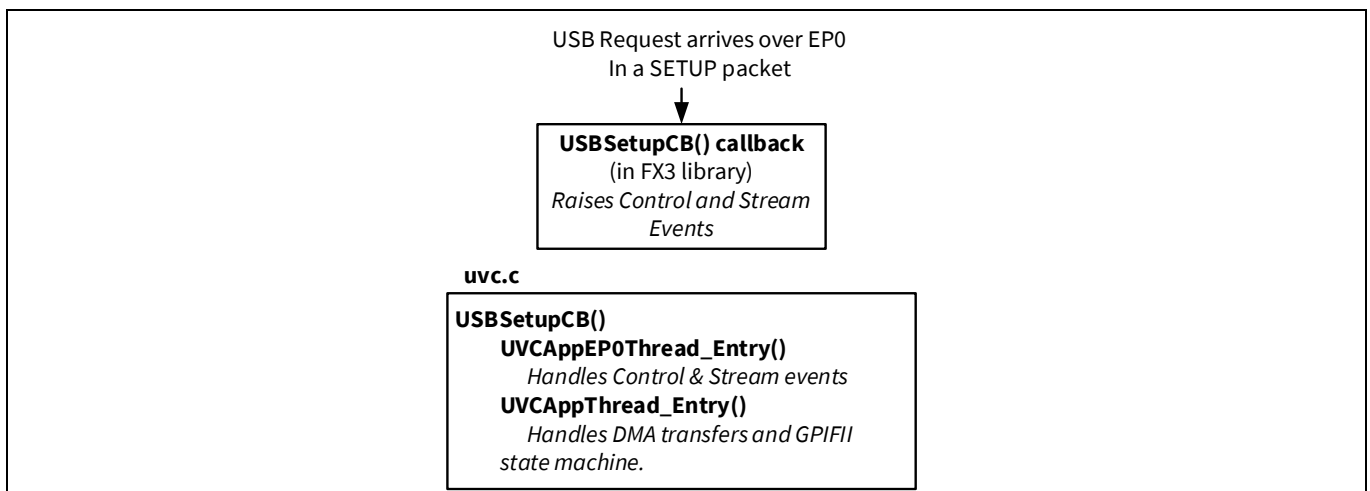

Figure 47 Camera project structure

## 5.1 Application thread

The two application threads enable concurrent functionality. The **UVCAppThread** (application) thread manages video data streaming. It waits for stream events before streaming starts and cleans up FIFOs in case of errors.

The firmware handles UVC-specific control requests (SET\_CUR, GET\_CUR, GET\_MIN, and GET\_MAX) over EP0, such as brightness, PTZ, and PROBE/COMMIT control. Class-specific control requests are handled by the **CyFxCvAppInUSBSetupCB** (CB=Callback) function. Whenever one of these control requests is received by FX3, this function raises corresponding events. EP0Thread then triggers on these events to serve the class-specific requests.

# How to implement an image sensor interface using EZ-USB™ FX3 in a USB Video Class (UVC) framework



## EZ-USB™ FX3 firmware

### 5.2 Initialization

**UVCAppThread\_Entry** calls **CyFxEVCApplnDebugInit** to initialize the UART debugging capability, **CyFxEVCApplnI2CInit** to initialize the I<sup>2</sup>C block of EZ-USB™ FX3, and **CyFxEVCApplnInit** to initialize the rest of the required blocks, DMA channels, and USB endpoints.

### 5.3 Enumeration

In the **CyFxEVCApplnInit** function, **CyU3PUsbSetDesc** function calls to ensure that EZ-USB™ FX3 enumerates as a UVC device. The UVC descriptors are defined in *cyfxuvcdscr.c* file. These descriptors are defined for an image sensor sending 16 bits per pixel using the uncompressed YUY2 format, with a resolution of 1280 x 720 pixels at 30 FPS. Refer to [Section 2.3.1](#) if you need to change these settings.

### 5.4 Configuring the image sensor through the I<sup>2</sup>C interface

The image sensor is configured using the I<sup>2</sup>C master block of EZ-USB™ FX3. **SensorWrite2B**, **SensorWrite**, **SensorRead2B**, and **SensorRead** functions (defined in *sensor.c*) are used to write and read image sensor configuration over I<sup>2</sup>C. The functions **SensorWrite2B** and **SensorWrite** call the standard API **CyU3PI2cTransmitBytes** to write data to the image sensor. The functions **SensorRead2B** and **SensorRead** call the standard API **CyU3PI2cReceiveBytes** to read data from the image sensor. For more details on these APIs, refer to the [EZ-USB™ FX3 SDK API guide](#).

### 5.5 Starting the video streaming

The USB host application, such as the VLC player or AMCap, or Webcamoid or VirtualDub uses the UVC driver to display the video, to set the USB interface and the USB alternate setting combination to one that streams video (usually Interface 0 Alternate setting 1), and to send a PROBE/COMMIT control. This is an indication by the host that it will shortly begin to stream video data. On a stream event, the USB host application starts requesting image data from EZ-USB™ FX3; EZ-USB™ FX3 is supposed to start sending the image data from the image sensor to the USB host. In the firmware, the **UVCAppThread\_Entry** function is an infinite loop. While there is no streaming, the main application thread waits in this loop until there is a stream event.

*Note: If there is no stream event, EZ-USB™ FX3 does not need to transfer any data. Therefore, the GPIF II state machine is disabled. Otherwise, all the DMA buffers will be full before the host application starts to pull data out of the DMA buffers, and EZ-USB™ FX3 would transmit a bad frame. Hence, the GPIF II state machine should be started only if there is a stream event.*

When EZ-USB™ FX3 receives a stream event, the main application thread calls **CyU3PGpifSMSwitch** function to start the GPIF II state machine. Inside this function, the firmware switches from any state to the start state (**START\_SCK0**) and restarts the GPIF state machine. Pass the start state name and start condition as arguments to the **CyU3PGpifSMSwitch** function. The “from” state and “end” state can be any invalid state (257 in the attached project) as this will ensure that GPIF II state machine switches from any state to the start state. The start state (**START\_SCK0**) and the start condition (**ALPHA\_START\_SCK0**) are defined in **cyfxgpif2config.h** file. The **cyfxgpif2config.h** file was generated from the GPIF II Designer tool as described in [Section 3.6](#).

*Note: The [EZ-USB™ FX3 SDK API guide](#) contains detailed information about GPIF II-related functions, such as **CyU3PGpifLoad** and **CyU3PGpifSMSwitch**.*

### 5.6 Setting up DMA buffers

The UVC spec requires adding a 12-byte header to each USB transfer (meaning each 16-KB DMA buffer in this application). However, the EZ-USB™ FX3 architecture requires that any DMA buffer associated with a DMA descriptor must have a size that is a multiple of 16 bytes.

Reserving 12 bytes in a DMA buffer for the EZ-USB™ FX3 CPU to fill in would place the DMA buffer boundary at a non-multiple of 16 bytes. Therefore, the DMA buffer size should be 16,384 minus 16, not 12. This makes the DMA buffer size, not including the 12-byte header that the EZ-USB™ FX3 firmware adds,  $16,384 - 16 = 16,368$  bytes. The DMA buffer is ordered as the 12-byte header, the 16,368 video bytes, and finally 4 unused bytes at the end of the DMA buffer. This creates a DMA buffer that can utilize the maximum USB BULK burst size of  $16 \times 1024$  byte packets, or 16,384 bytes.

### 5.7 Handling the DMA buffers during video streaming

The **CyFxDmaChannelInit** function creates a manual DMA channel with callback notification for producer and consumer events. This notification is used to track the amount of data sent by the sensor and the amount of data read by the host. A DMA buffer becomes available to the EZ-USB™ FX3 CPU when the GPIF II produces a DMA buffer and FX3 gets a pointer to this buffer via **CyU3PDmaMultiChannelGetBuffer**. This buffer is committed to the USB via **CyU3PDmaMultiChannelCommitBuffer**. Whenever the USB throughput is slower than the speed at which the buffers are filled up (by GPIF II state machine), number of buffers with actual video data increases. At some point, all the buffers will be full; committing one more buffer will result in an error. This is called as commit buffer failure. In such cases, the DMA reset event is called, and EZ-USB™ FX3 will stop and restart streaming.

At the end of a frame, usually the last DMA buffer is partially filled. In this case, the firmware must forcefully wrap up the DMA buffer on the producer side to trigger a produce event and then commit the DMA buffer to the USB with the appropriate byte count. The forceful wrap-up of the DMA buffer (produced by GPIF II) is executed in the GPIF II callback function **CyU3PDmaMultiChannelSetWrapUp**. The **CyFxDmaChannelCB** callback function is triggered when GPIF II sets a CPU interrupt. As shown in the GPIF II state diagram, this interrupt is raised when the frame valid signal is deasserted.

The UVC header carries information about the frame identifier and an end-of-frame marker. At the end of a frame, the EZ-USB™ FX3 firmware sets bit 1 and toggles bit 0 of the second UVC header byte (see “CyFxDmaChannelAddHeader”). Toggle the UVC header FID bit only after the frame ends.

A slower USB host will result in commit buffer failures and resetting of DMA to restart video stream. If the Sensor/ISP fails to send video on time, the video will eventually freeze or show some jitters. Frame timer is an essential entity to avoid this. The frame timer starts when the video streaming starts. It is reset when EZ-USB™ FX3 receives first buffer from the Sensor and restarts to ensure that each producer buffers arrive on time.

### 5.8 Terminating the video streaming

There are three ways image streaming can be terminated: The camera may be disconnected from the host, the USB host program may close, or the USB host may issue a reset or suspend request to EZ-USB™ FX3. These actions trigger the **CY\_FX\_UVC\_STREAM\_ABORT\_EVENT** event (refer to the **CyFxDmaChannelAbortHdlr** function). This action does not always happen when there is no data in the EZ-USB™ FX3 FIFO. This means that proper cleanup is required. The firmware resets streaming-related variables, and resets the DMA channel in the **UVCAppThread\_Entry** loop. It does not call the **CyU3PDmaMultiChannelSwitch** function because no streaming is required. The firmware then waits for the next streaming event to occur.

When the application closes, it issues a clear feature request on a Windows platform or a set interface with alternate setting = 0 request on a Mac platform. Streaming stops when this request is received. This request is

# How to implement an image sensor interface using EZ-USB™ FX3 in a USB Video Class (UVC) framework



## EZ-USB™ FX3 firmware

handled in the **CyFxBVUVCAppInUSBSetupCB** function under switch case **CY\_U3P\_USB\_TARGET\_ENDPT** and request **CY\_U3P\_USB\_SC\_CLEAR\_FEATURE**.

### 5.9 Adding a “debug” interface

This section shows how to add a third USB interface to the camera application to use for debug or other custom purposes.

The `#define USB_DEBUG_INTERFACE` switch in the **uvc.h** file enables code in **cyfxuvcdscr.c**, **uvc.h** and **uvc.c** files. The example provided reads and writes image sensor registers over I<sup>2</sup>C.

#### 5.9.1 Debug interface details

Two bulk endpoints are defined for this interface. EP 4 OUT is configured as the debug command BULK endpoint, and EP 4 IN is configured as the debug response BULK endpoint. When the firmware with the enabled debug interface runs, EZ-USB™ FX3 reports three interfaces during enumeration. The first two are the UVC control and streaming interfaces, and the third is the debug interface. The third interface needs to be bound to the **CyUSB3.sys** driver, which is provided as a part of the EZ-USB™ FX3 SDK. You can install the driver according to the following instructions. (A 64-bit Windows 7 system is used as an example. XP users will have to modify the .inf file to include the VID/PID and then use the modified .inf file to bind the **cyusb3.sys** driver to this interface.)

1. Open Device Manager, right-click on EZ-USB™ FX3 (or equivalent) under **Other devices**, and choose **Update Driver Software...**

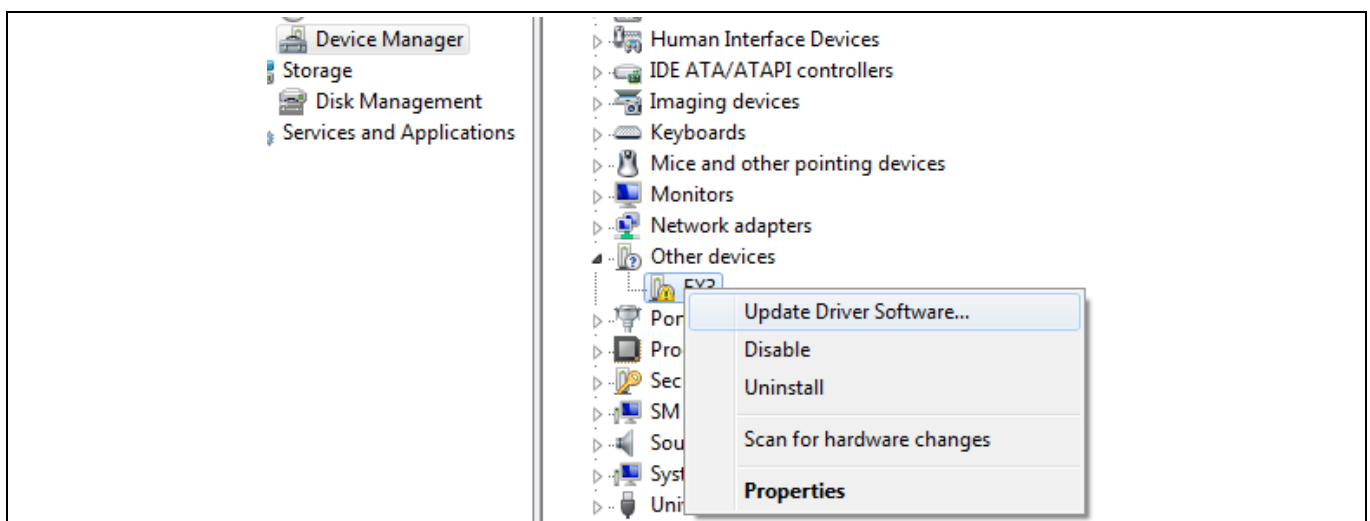

2. Choose **Browse my computer for driver software** on the next screen.



# How to implement an image sensor interface using EZ-USB™ FX3 in a USB Video Class (UVC) framework



## EZ-USB™ FX3 firmware

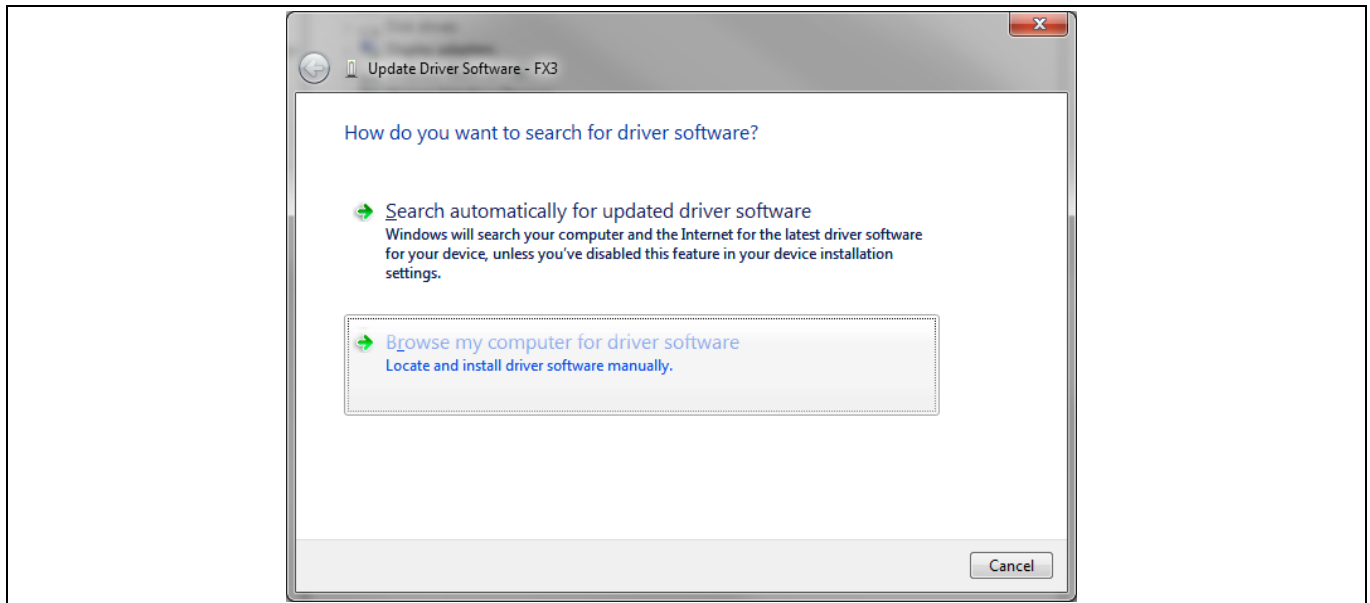

3. Choose **Let me pick from a list of device drivers on my computer** on the following screen.

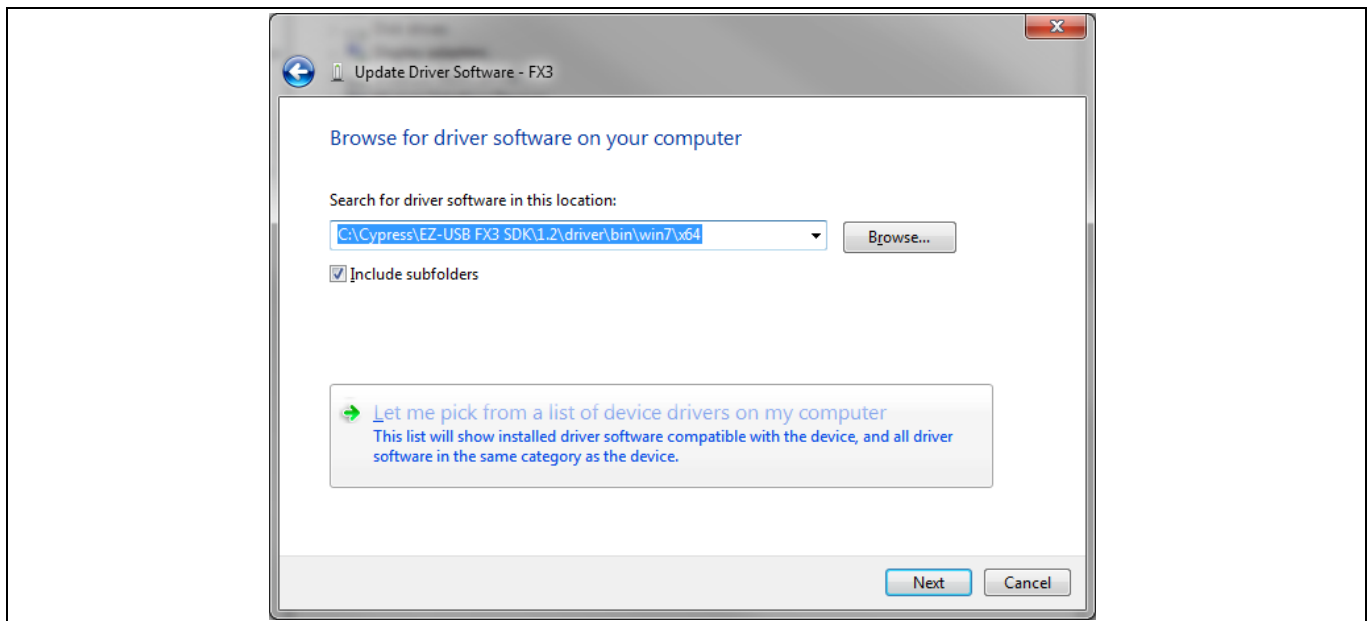

4. Click **Next** on the following screen.

# How to implement an image sensor interface using EZ-USB™ FX3 in a USB Video Class (UVC) framework



## EZ-USB™ FX3 firmware

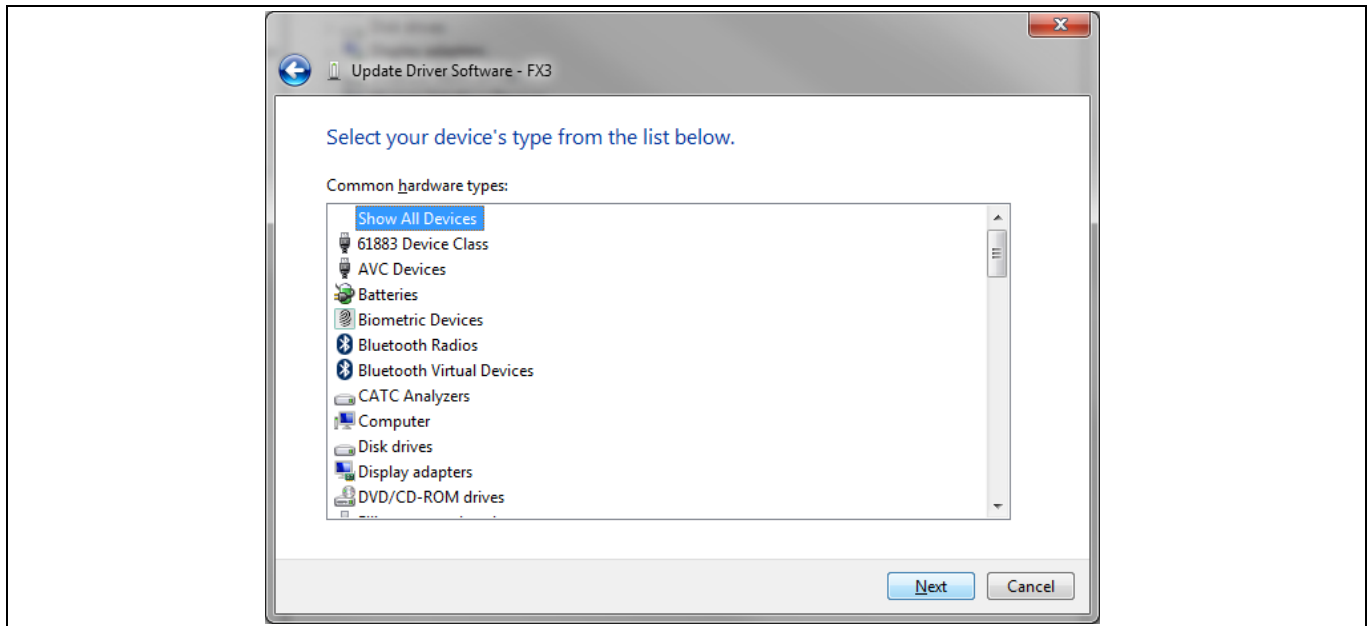

5. Click **Have Disk...** to choose the driver.

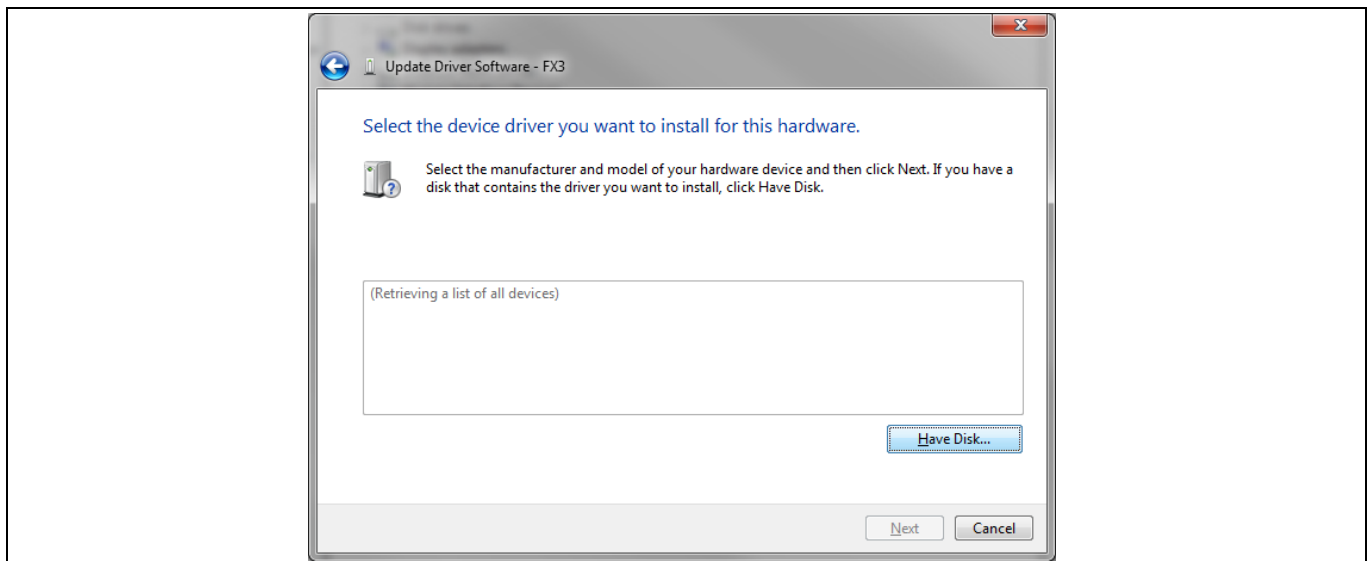

6. Browse for the cyusb3.inf file in the <SDK installation>\<version>\driver\bin\<OS>\x86 or \x64 folder, and click **OK**.



# How to implement an image sensor interface using EZ-USB™ FX3 in a USB Video Class (UVC) framework



## EZ-USB™ FX3 firmware

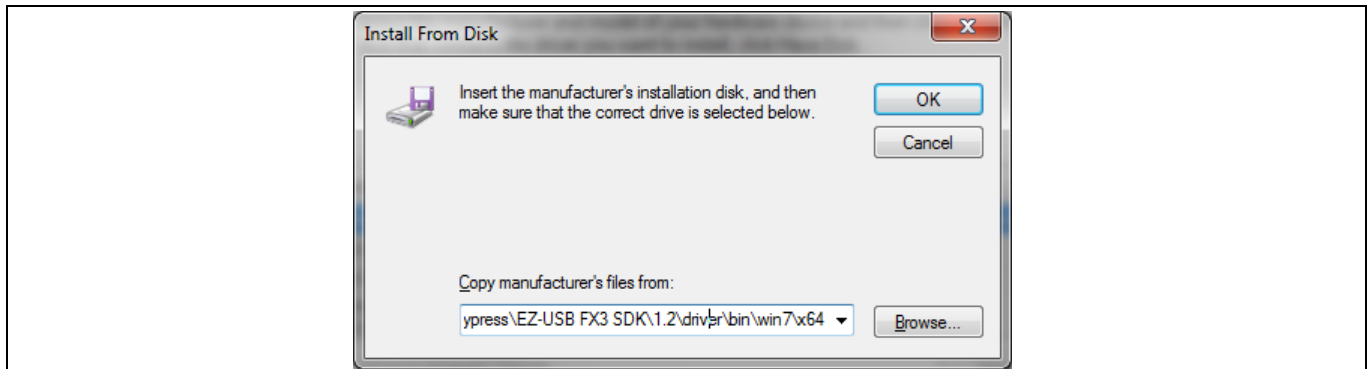

7. Choose an OS version and click **Next** to install.

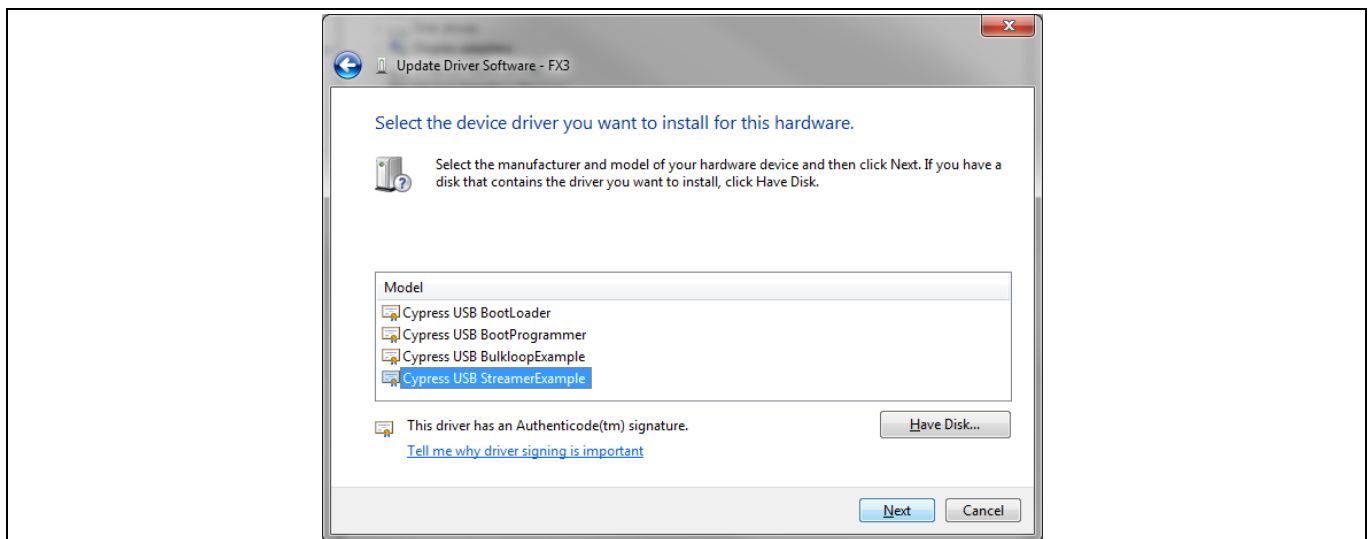

8. Click **Yes** on the warning dialog box if it appears.

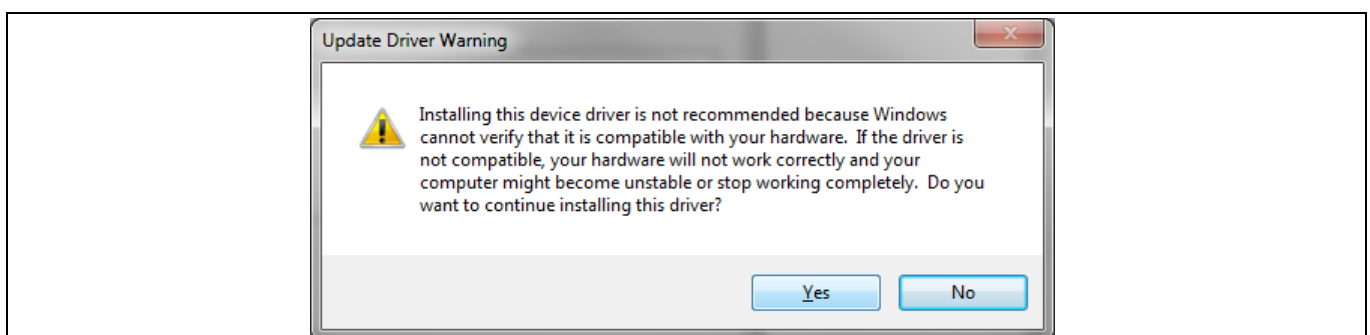

After the driver is bound to the third interface, the device will show up in the Infineon USB Control Center application. You can access the FX3 firmware from here as a vendor-specific device. The current implementation of the debug interface allows reading and writing of the image sensor registers by using the EP4-OUT command and the EP4-IN response endpoints. These endpoints are accessed in the USB Control Center under <FX3 device name> → Configuration 1 → Interface 2 → Alternate Setting 0, as shown in the following figure. Use the Data Transfers tab to send a command or to retrieve a response after sending a command.

# How to implement an image sensor interface using EZ-USB™ FX3 in a USB Video Class (UVC) framework



## EZ-USB™ FX3 firmware

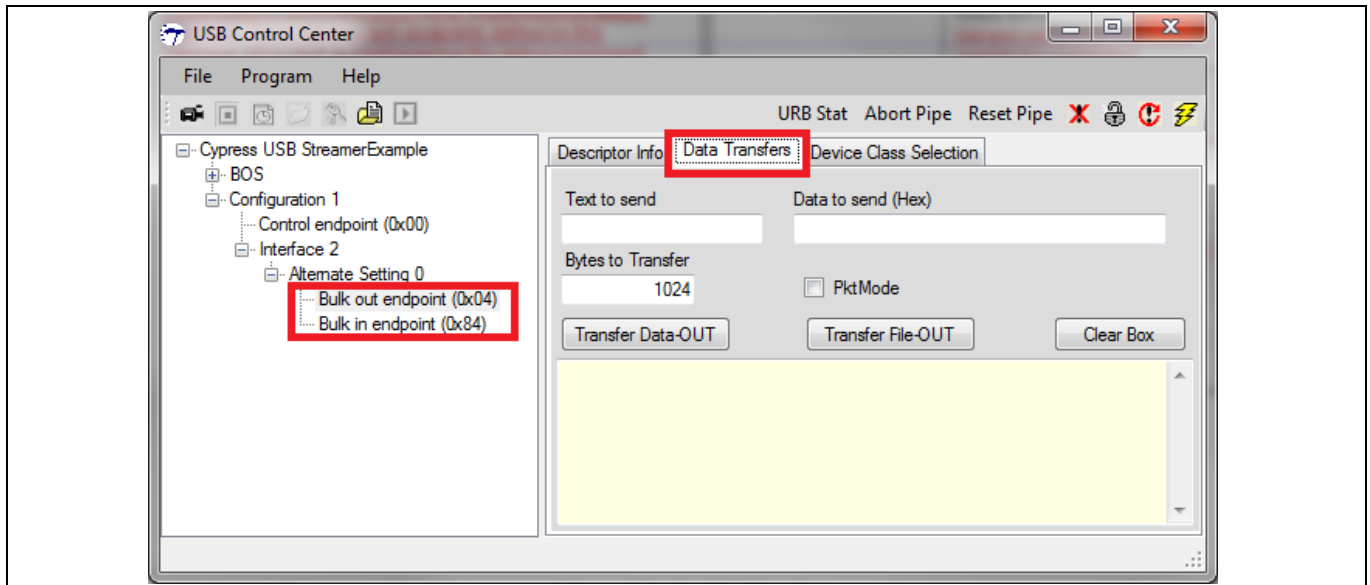

### 5.9.2 Using the debug interface

Four commands are implemented in the debug interface: single read, sequential read, single write, and sequential write. There is no error checking, so enter commands carefully. You can implement error checks to ensure proper functionality. The I<sup>2</sup>C registers are 16 bits wide and are addressed using 16 bits.

#### 5.9.2.1 Single read

1. Choose the command endpoint and type the command in hex under the Data Transfers. The format of a single read is 0x00 <register address high byte> <register address low byte>. The figure shows the read command for register address 0x3002. Do not use a space while typing in the hex data box. For example, click the hex data field and type “003002”.

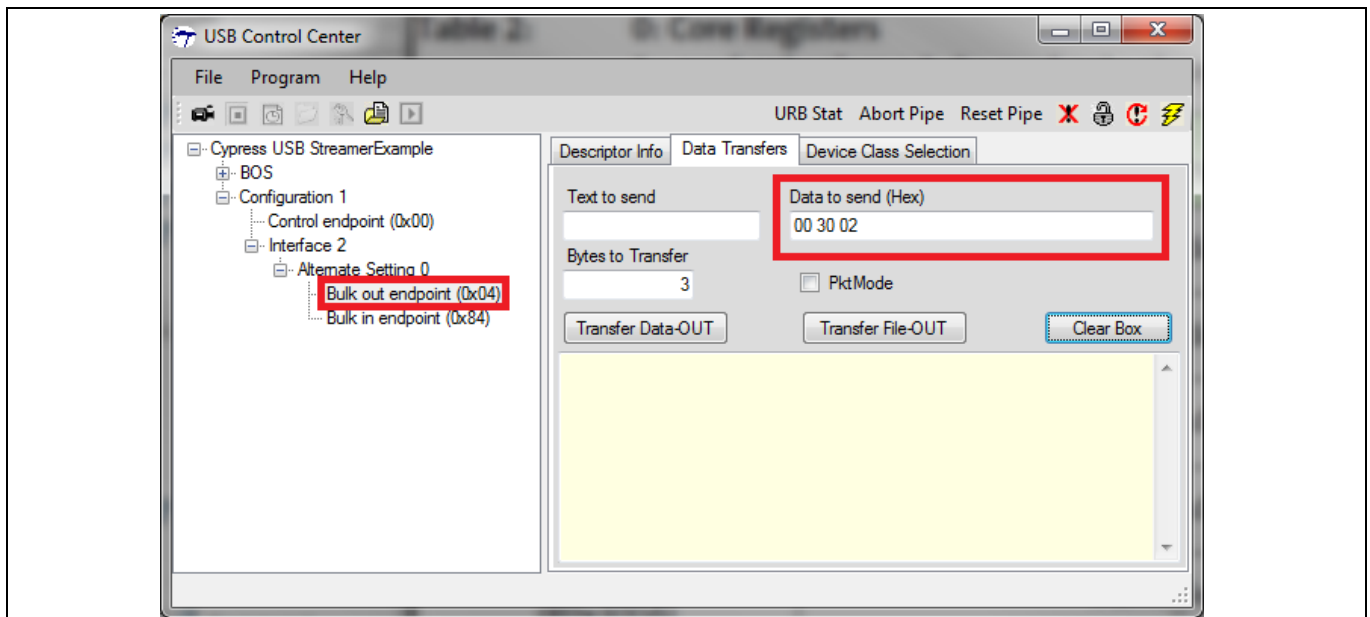

# How to implement an image sensor interface using EZ-USB™ FX3 in a USB Video Class (UVC) framework



## EZ-USB™ FX3 firmware

2. Click **Transfer Data-OUT** to send the command.

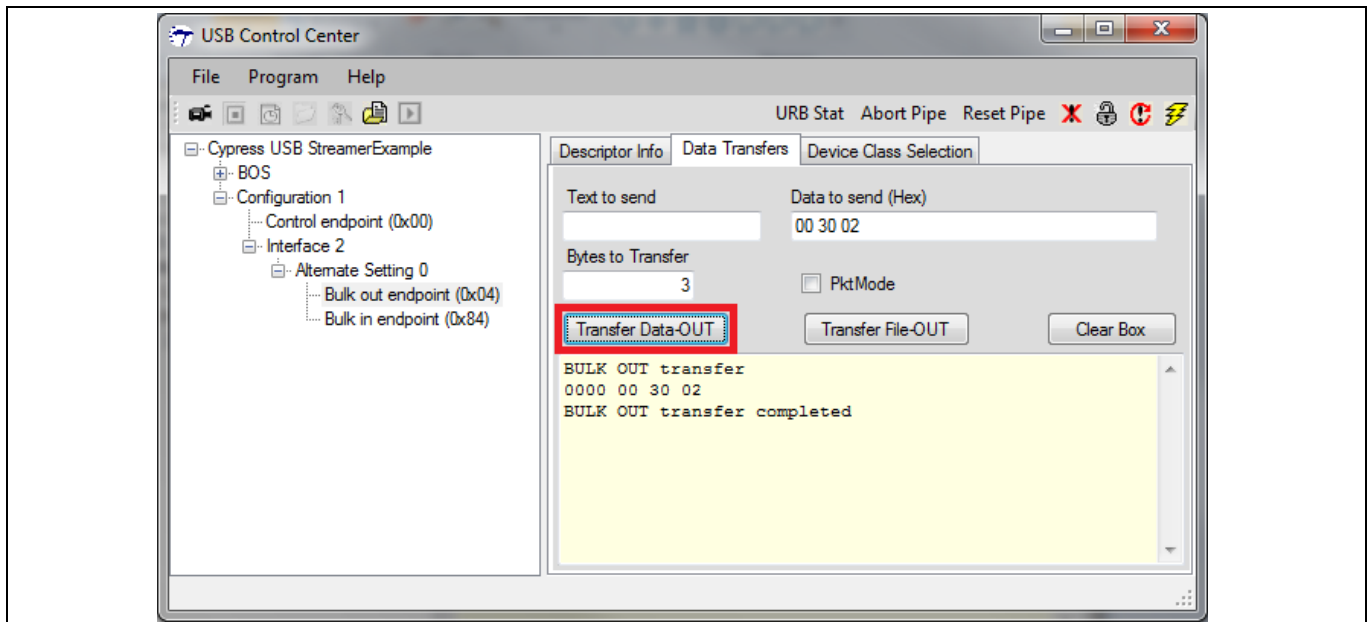

3. Choose the response endpoint and set the **Bytes to Transfer** field to “3” to read out the response of the single read command.

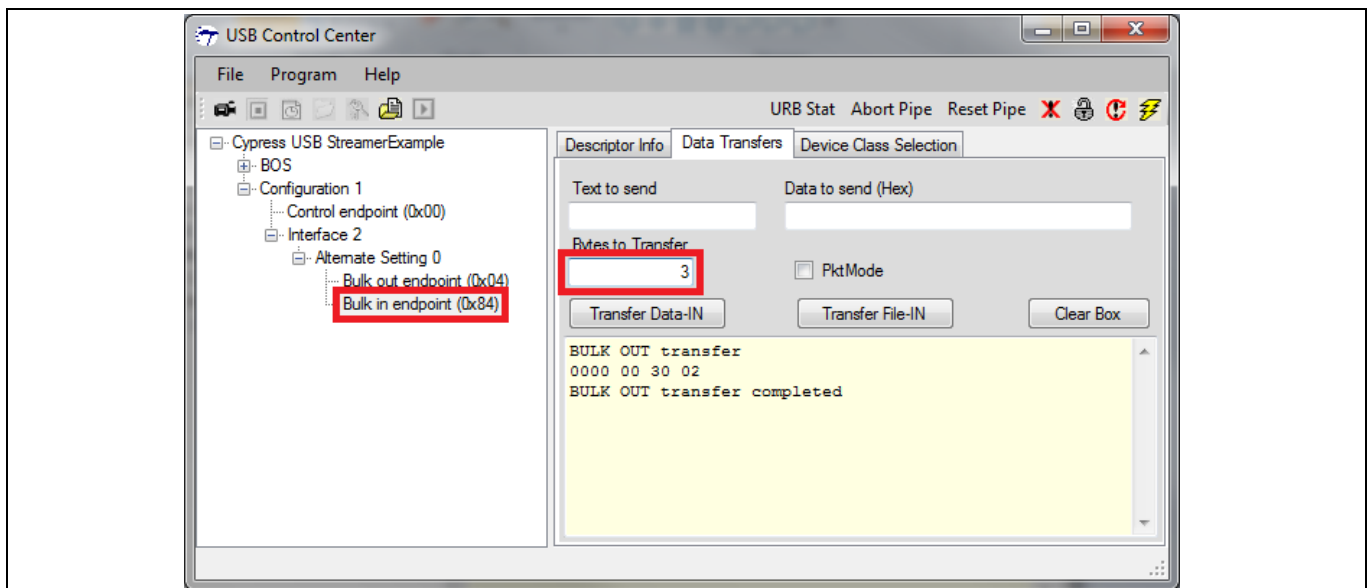

# How to implement an image sensor interface using EZ-USB™ FX3 in a USB Video Class (UVC) framework



## EZ-USB™ FX3 firmware

4. Click “Transfer Data-IN” to receive the response.

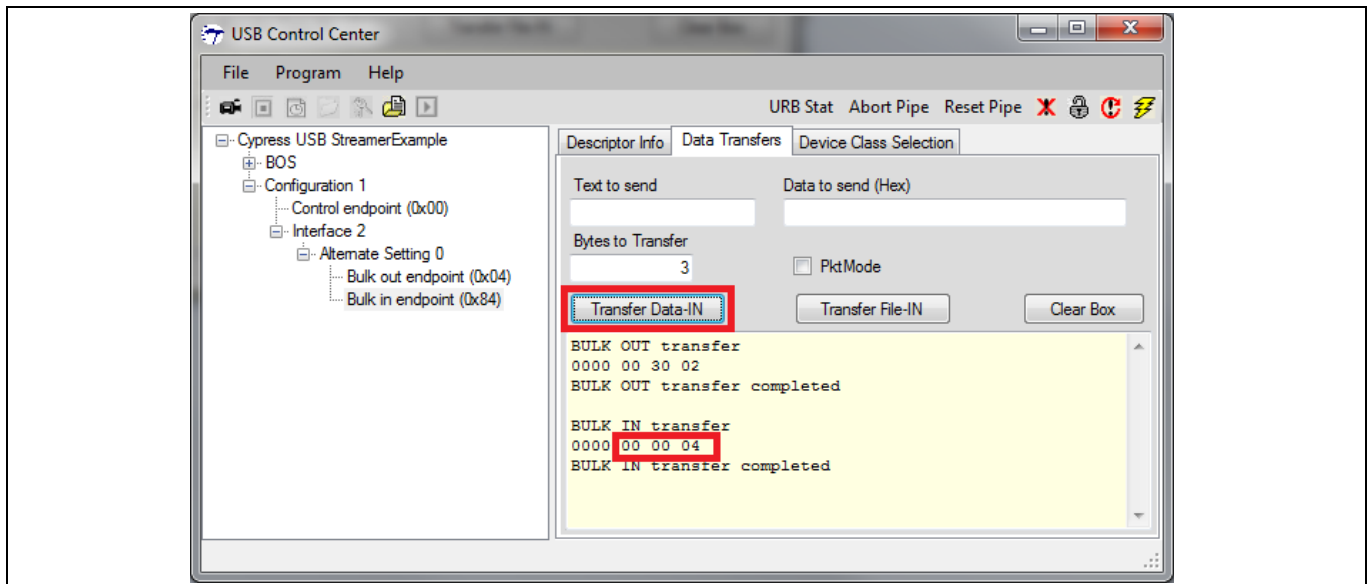

5. The first byte of response is the status. Status=0 means the command passed; any other value means that the command failed. The following bytes indicate that the value of the register read back is 0x0004. This example shows a failed transfer in which the status is non-zero and the rest of the bytes are stale values from a previous transfer.

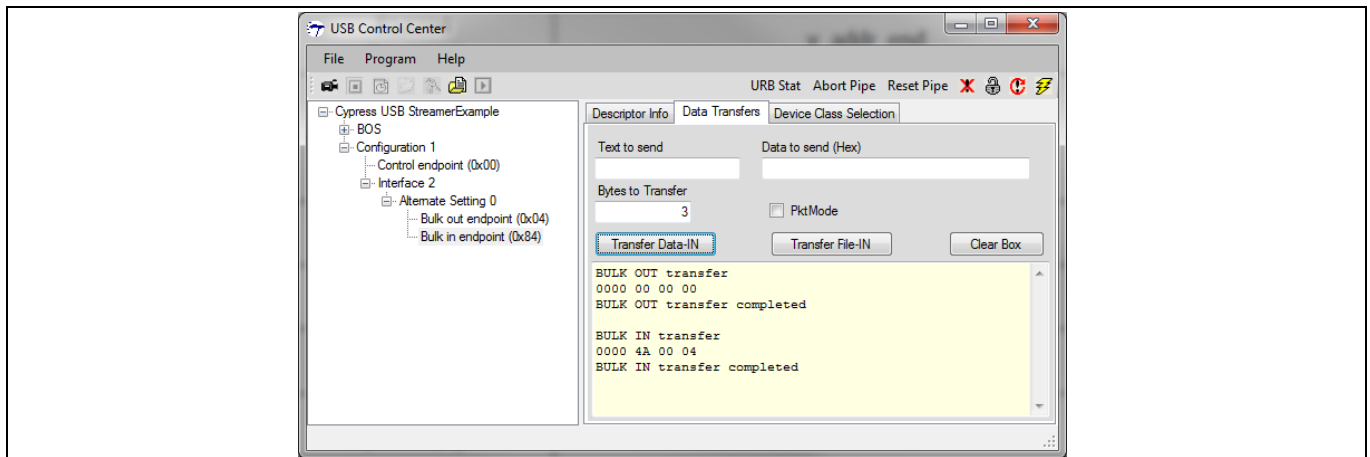

# How to implement an image sensor interface using EZ-USB™ FX3 in a USB Video Class (UVC) framework



## EZ-USB™ FX3 firmware

### 5.9.2.2 Sequential read

1. Choose the command endpoint and type the command in hex under Data Transfers. The format of a sequential read is  $0x00$  <register address high byte> <register address low byte> <N>. The figure shows a read command for four ( $N=4$ ) registers starting at register address  $0x3002$ .

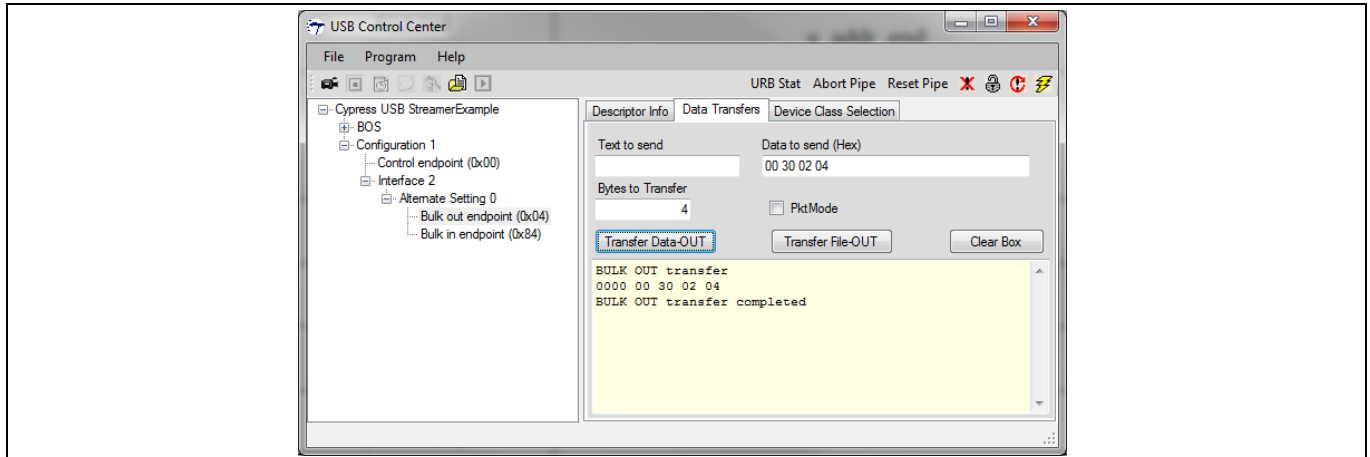

2. The Bytes to Transfer for the response is  $(N*2+1) = 9$  for this case. The figure shows the values read by EZ-USB™ FX3.

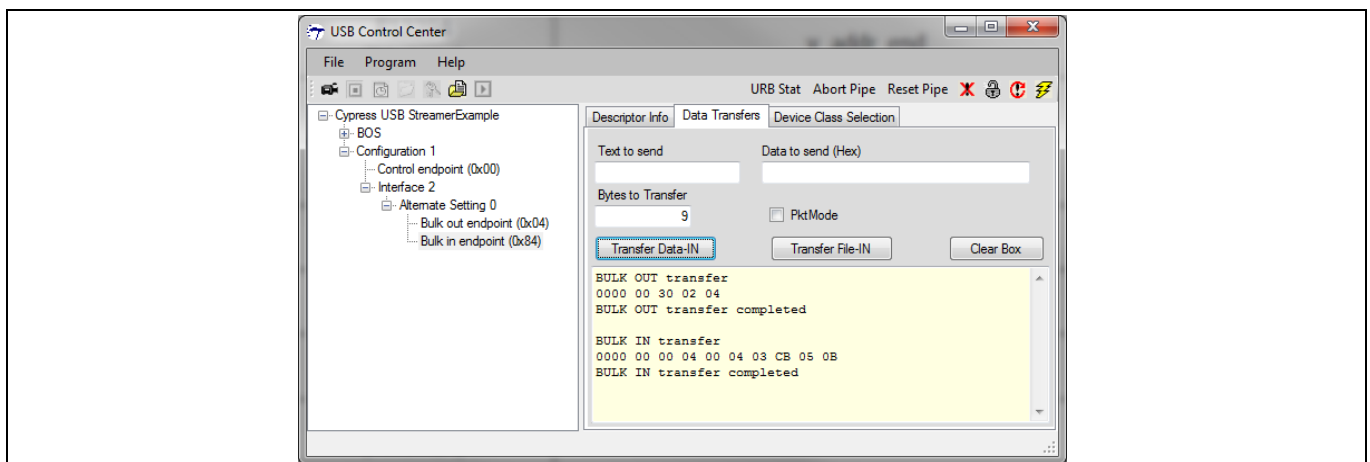

# How to implement an image sensor interface using EZ-USB™ FX3 in a USB Video Class (UVC) framework



## EZ-USB™ FX3 firmware

### 5.9.2.3 Single write

1. Choose the command endpoint and type the command in hex under Data Transfers. The format of a single write is 0x01 <register address high byte> <register address low byte> <register value high byte> <register value low byte>. The figure shows the write command to write a value of 0x0006 at register address 0x3002.

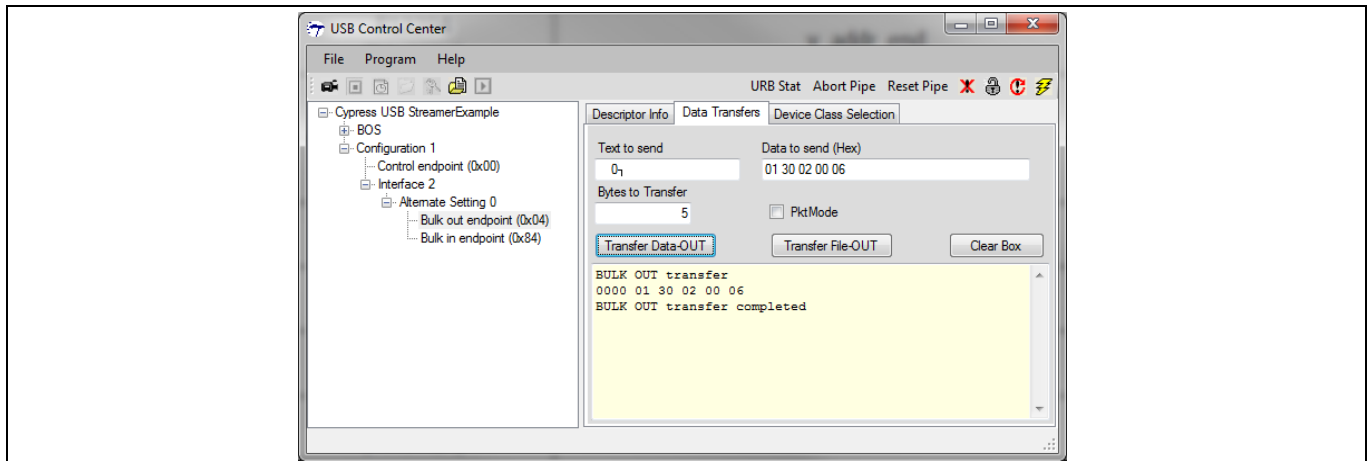

2. The response for a single write contains three bytes: <Status> <register value high byte> <register value low byte>. These register values are read back after writing, which means you will see the same values sent in the command.

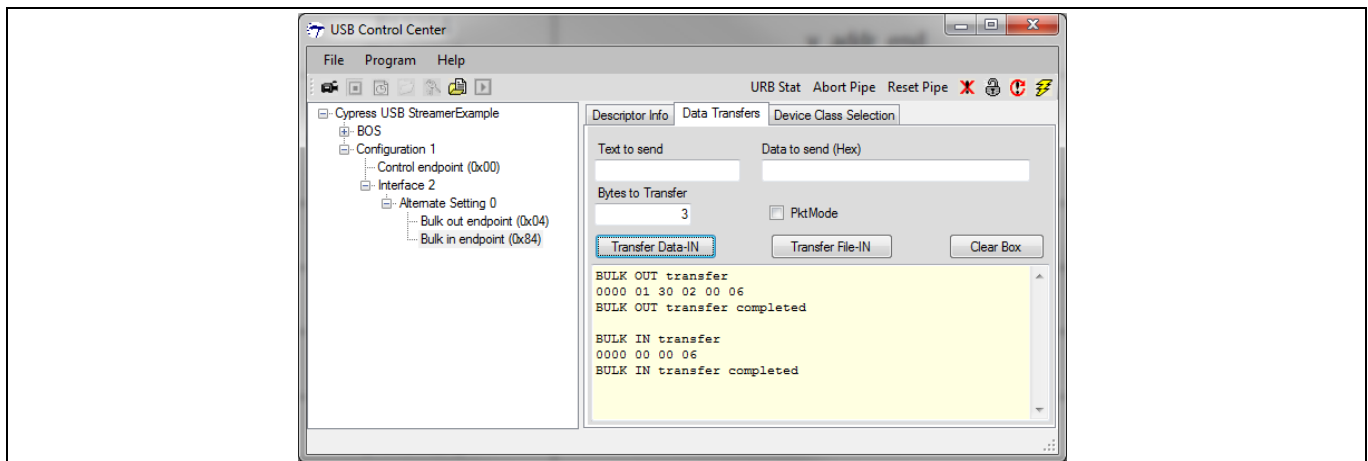

# How to implement an image sensor interface using EZ-USB™ FX3 in a USB Video Class (UVC) framework



## EZ-USB™ FX3 firmware

### 5.9.2.4 Sequential write

1. Choose the command endpoint and type the command in hex under Data Transfers. The format of a sequential write is  $0x01$  <register address high byte> <register address low byte> ((<register value high byte> <register value low byte>) \* N times) to write N number of registers. The figure shows writing values  $0x0006$ ,  $0x0008$ , and  $0x03C0$  to registers  $0x3002$ ,  $0x3004$ , and  $0x3006$  sequentially (N=3).

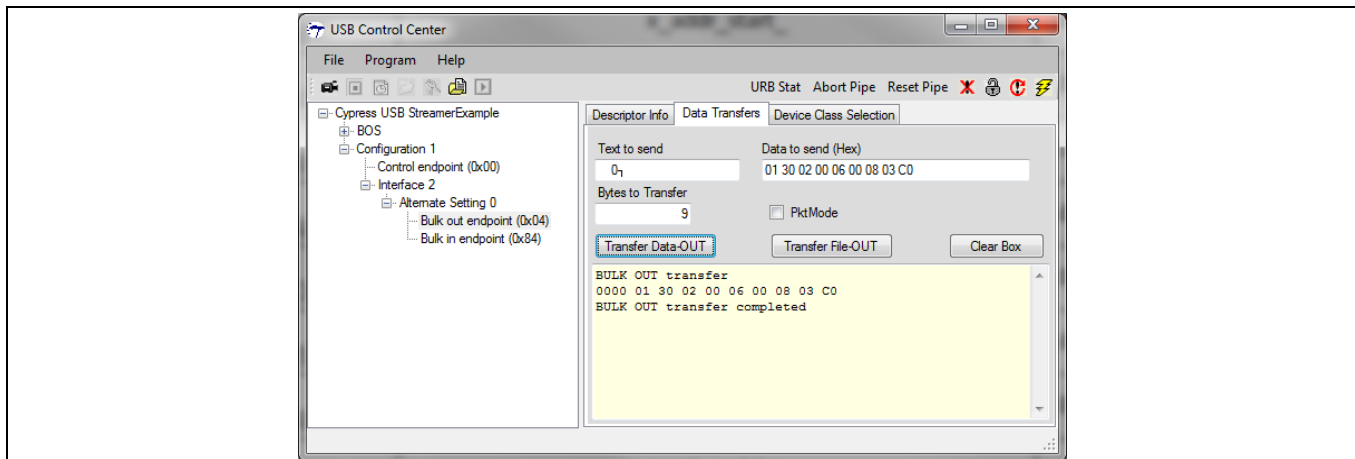

2. The response is <Status> (<register value high byte> <register value low byte>) \* N values. For this example, the total bytes to transfer is  $(2*N+1) = 7$ .

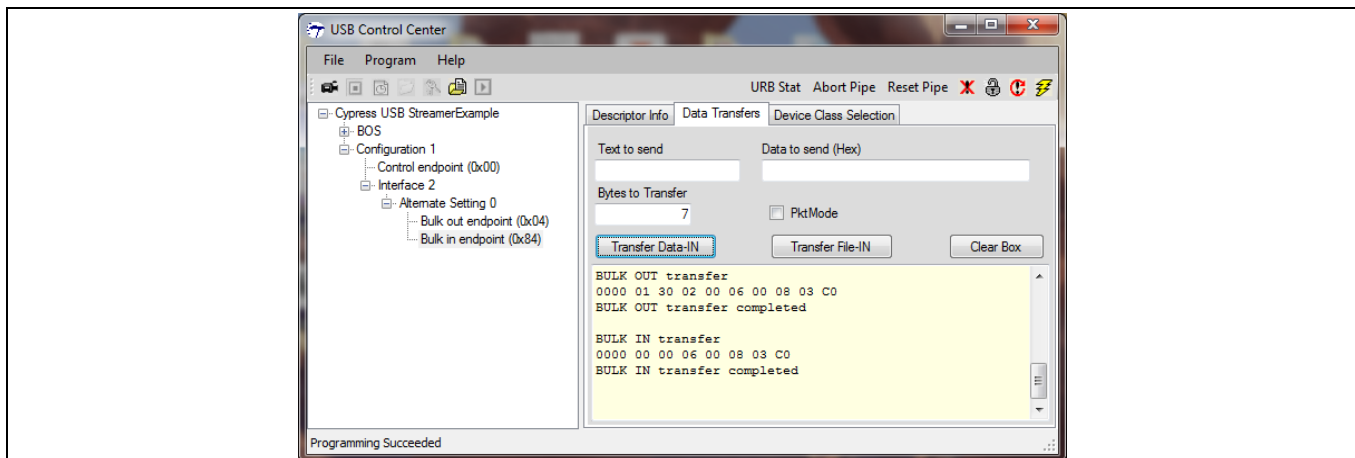

## Hardware setup

### 6 Hardware setup

The current project has been tested on a setup that includes the SuperSpeed explorer kit (CYUSB3KIT-003), ON Semiconductor image sensor interconnect board (CYUSB3ACC-004A) and an ON Semiconductor image sensor board (MT9M114EBLSTCH3-GEVB / MT9M114\_55CSP\_HB\_DEMO3\_REV0). Details on how to obtain these components are summarized below:

#### 6.1 Hardware requirement

1. ON Semiconductor MT9M114 image sensor board (MT9M114EBLSTCH3-GEVB/MT9M114\_55CSP\_HB\_DEMO3\_REV0) (Buy from ON Semiconductor distributors)
2. SuperSpeed explorer kit (CYUSB3KIT-003)<sup>1</sup>.
3. CYUSB3ACC-004A<sup>2</sup> (interconnect board for ON Semiconductor image sensor) for SuperSpeed explorer kit.
4. Use a USB 3.0 host-enabled computer to evaluate SuperSpeed performance.

#### 6.2 SuperSpeed explorer kit board setup

Prepare the board for testing the video application using these steps:

1. Set the jumper settings on the SuperSpeed explorer kit (CYUSB3KIT-003) and the ON Semiconductor image sensor board (MT9M114\_55CSP\_HB\_DEMO3\_REV0) as shown in [Table 9](#) and [Table 10](#).

**Table 9 Jumper settings – ON Semiconductor image sensor board (MT9M114\_55CSP\_HB\_DEMO3\_REV0)**

Jumper/header No.	Jumper/header name	Pin setting	Description
P1	OE_L	1-2	Enable parallel interface
P2	CONFIG	2-3	Set to normal mode
P4	FLASH	Open	Connection to external flash
P5	TRST	1-2	Set to normal mode
P6	SADDR	1-2	Slave address: 0x90
P7	+VDDIO	2–3	2.8 V operation of sensor
P8	UART	Open	UART shutdown (Tristate)
P11	EEPROM	Closed (A1 column)	Active low(A1)
P15	I2C CONNECTOR	1–2 and 3–4	Master and sensor I2C connected
P32	CLOCK SELECTION	3–5 and 1–2	Multi-camera, Master mode; Onboard oscillator

**Table 10 SuperSpeed explorer kit (CYUSB3KIT-003)**

Jumper/header No.	Jumper/header name	Pin setting	Description
J2	VIO1_3	Closed	VDDIO voltage selection (2.8V)
J3	VBUS_JUMPER	Closed	Bus powered
J4	PMODE	Closed	USB boot

<sup>1</sup> See 11 for details on using FX3 DVK (CYUSB3KIT-001).

<sup>2</sup> See 12 for details on using Aptina™ image sensor interconnect board (CYUSB3ACC-004) with Aptina image sensor.



# How to implement an image sensor interface using EZ-USB™ FX3 in a USB Video Class (UVC) framework



## Hardware setup

Jumper/header No.	Jumper/header name	Pin setting	Description
J5	SRAM_ENABLE	Open	Disable the onboard SRAM

- Assemble the SuperSpeed explorer kit, Interconnect board, and the ON Semiconductor image sensor board as shown in **Figure 48**.

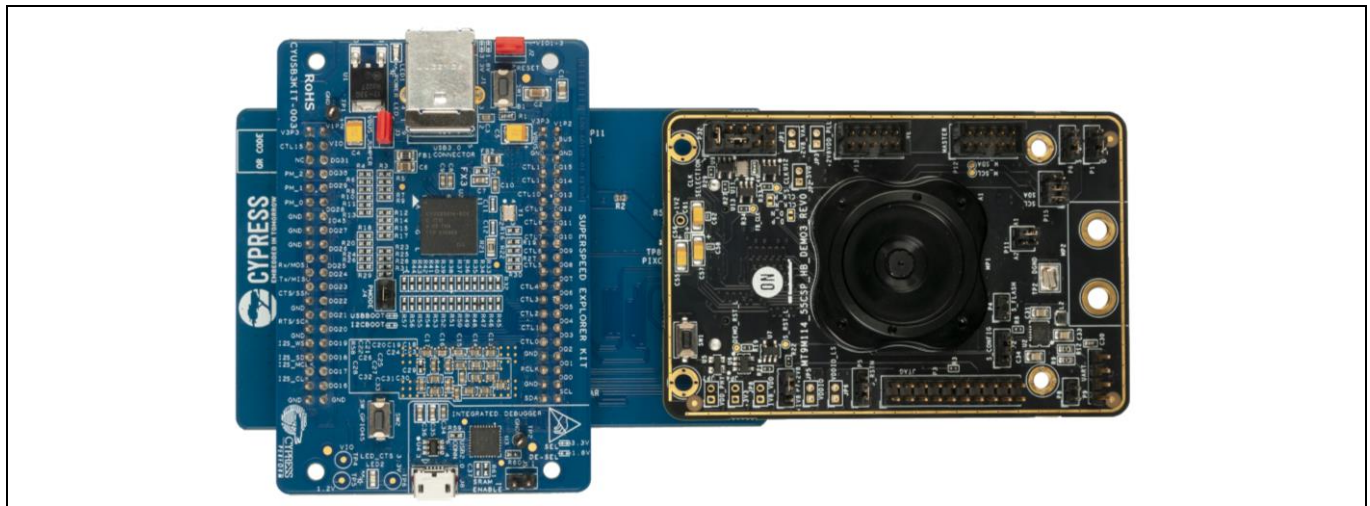

**Figure 48 SuperSpeed explorer kit, ON Semiconductor image sensor interconnect and sensor board assembly**

- Plug the SuperSpeed explorer kit board into the USB port of the computer using the USB 3.0 cable provided with the kit.
- Load the firmware into the board using the Control Center application provided as part of the EZ-USB™ FX3 SDK. The firmware source and pre-built image are provided in **AN75779.zip**. For detailed instructions, see **AN75705 - Getting started with EZ-USB™ FX3**. Here are brief instructions:
  - Start the Control Center application. When you plug in the EZ-USB™ FX3 explorer board, it will be recognized as an Infineon EZ-USB™ FX3 USB bootloader device (**Figure 49**).

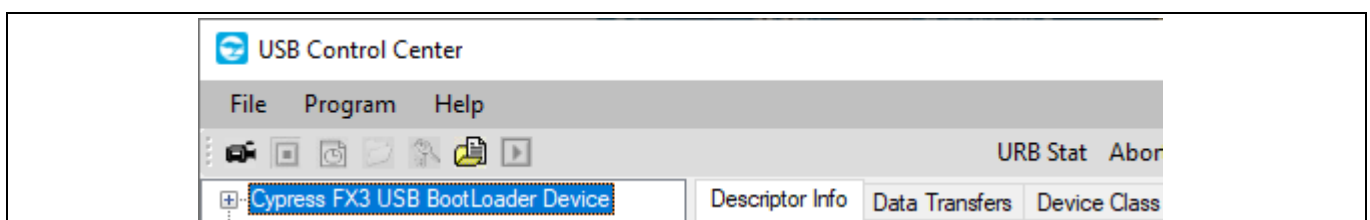

**Figure 49 EZ-USB™ FX3 enumerates as a bootloader**

- Select **Program > FX3 > RAM** and navigate to the *cyfx\_uvc\_an75779.img* file provided with the attachment to this application note (**Figure 50**). Note that the device will lose the loaded firmware and re-enumerate as Infineon FX3 USB bootloader device if it is power-cycled after programming.

# How to implement an image sensor interface using EZ-USB™ FX3 in a USB Video Class (UVC) framework



## Hardware setup

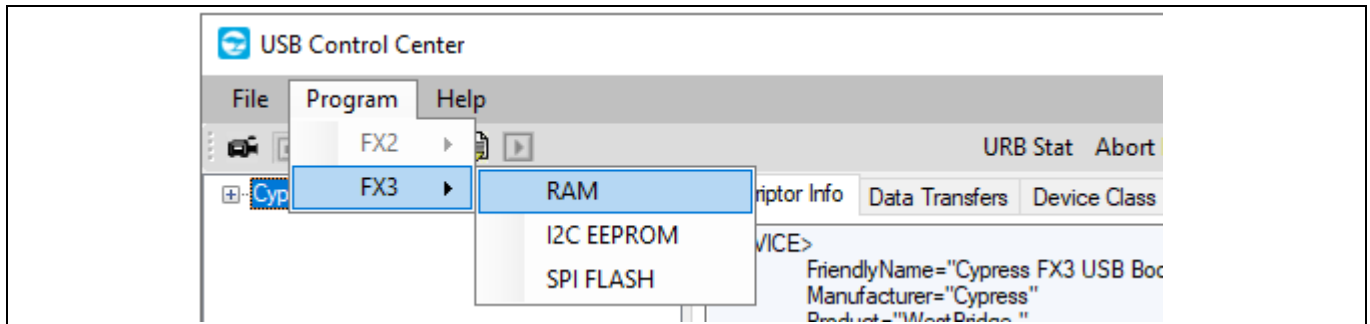

**Figure 50 Loading code into EZ-USB™ FX3 RAM**

The Control Center application will show the status of programming on the status bar. On successful programming, the device will also disappear on the Control Center device list as the device will now enumerate as a UVC Class device. The device can be seen in Windows Device Manager under **Cameras** or **Imaging Devices** type (Figure 51).

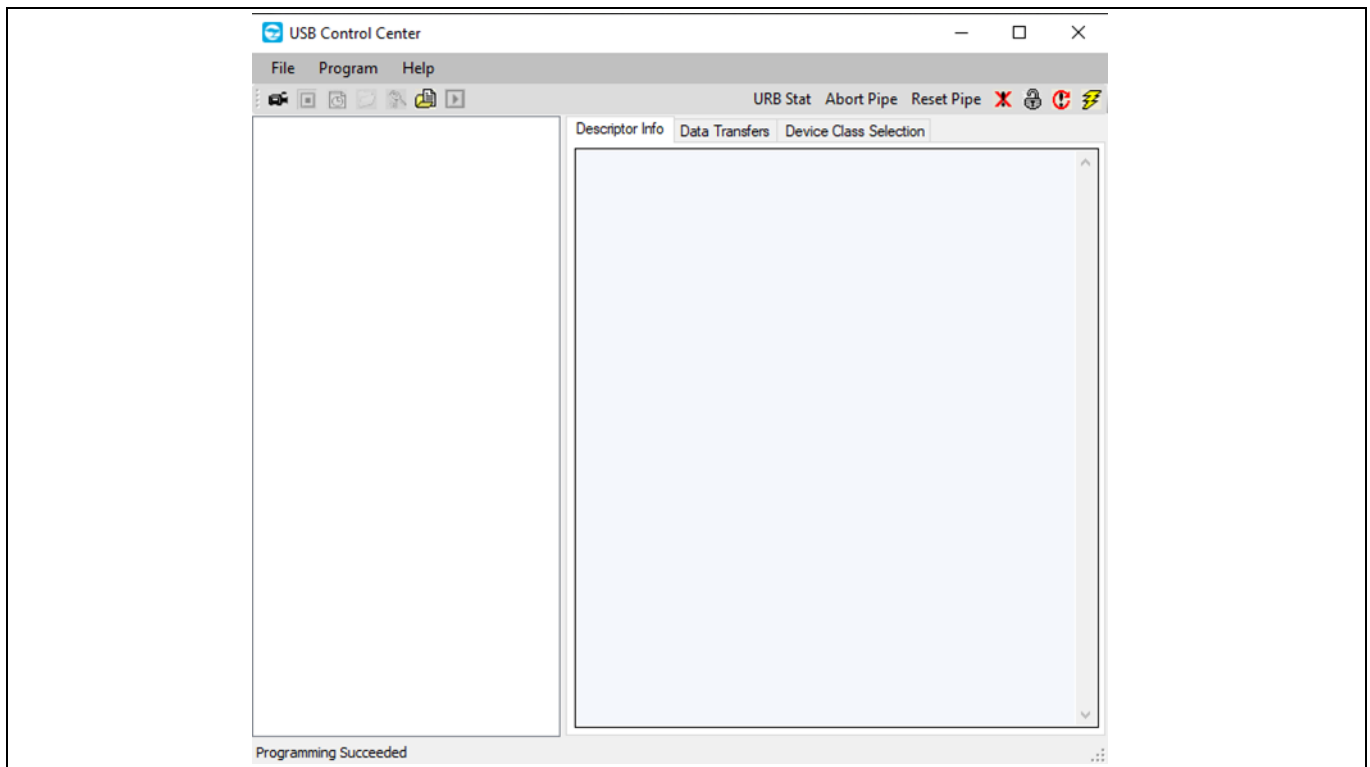

**Figure 51 Programming succeeded message displayed on the status bar**

## UVC-based host applications

### 7 UVC-based host applications

Various host applications allow you to display and capture video from a UVC device. The VLC media player is a popular choice. Another widely used Windows application is **VirtualDub** (an open-source application). Other additional Windows apps are **MPC-HC** player (an open-source application), **AMCap** (Version 8.0), **Webcamoid** and **Debut Video Capture software**.

Linux systems can use the V4L2 driver and VLC media player to stream video. The VLC media player is available on the web. **Webcamoid** is also available Linux platform.

Mac platforms can use **Webcamoid**, FaceTime, iChat, Photo Booth, and Debut Video Capture software to create an interface with the UVC device to stream video.

*Note: Use open source application like **VirtualDub** and **MPC-HC** to design your own host application. **AmCap sample** is also available on the Windows SDK.*

#### 7.1 Running the demo

A precompiled code image file for the demo on EZ-USB™ FX3 explorer kit is available in **AN75779.zip**.

Run this code using the following steps:

1. Load the precompiled firmware image into the EZ-USB™ FX3 UVC setup as described in **Section 6.2**.
2. At this point, the setup will re-enumerate as a UVC device. The operating system installs UVC drivers; no additional drivers are required.
3. Open the host application (for example, VirtualDub).
4. Choose **File > Capture AVI**.

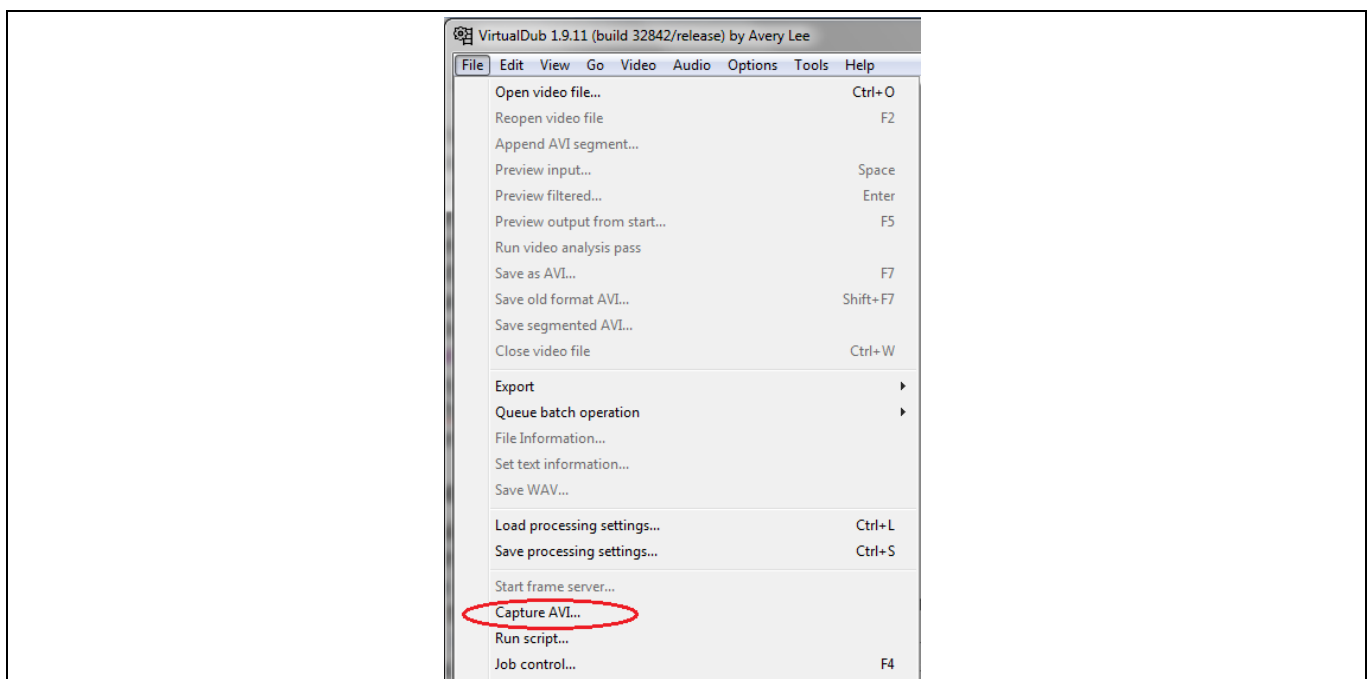

# How to implement an image sensor interface using EZ-USB™ FX3 in a USB Video Class (UVC) framework



## UVC-based host applications

5. Choose **Device > FX3 (Direct Show)**, and this will start streaming images.

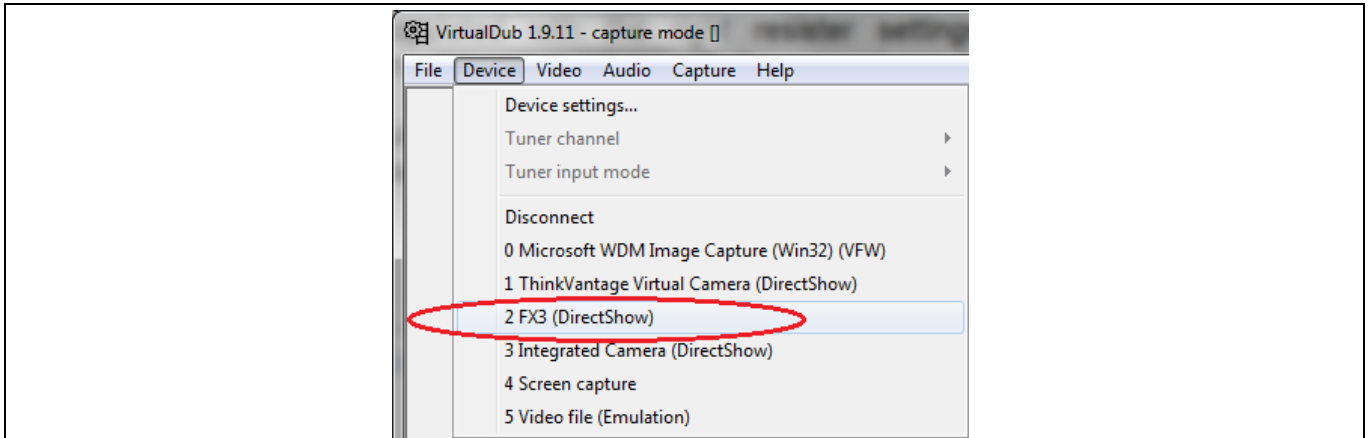

6. The bottom right shows the actual frame rate.

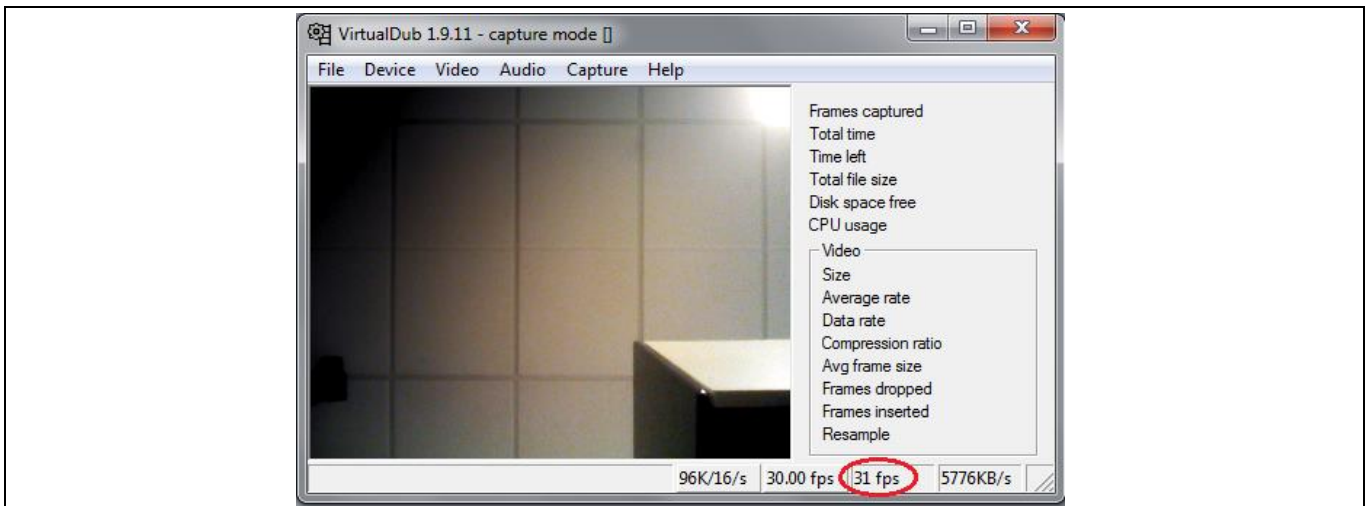

# How to implement an image sensor interface using EZ-USB™ FX3 in a USB Video Class (UVC) framework



## UVC-based host applications

- 7. You can also use **Video > Capture Pin** to select among different supported resolutions and to see which resolution is currently active.

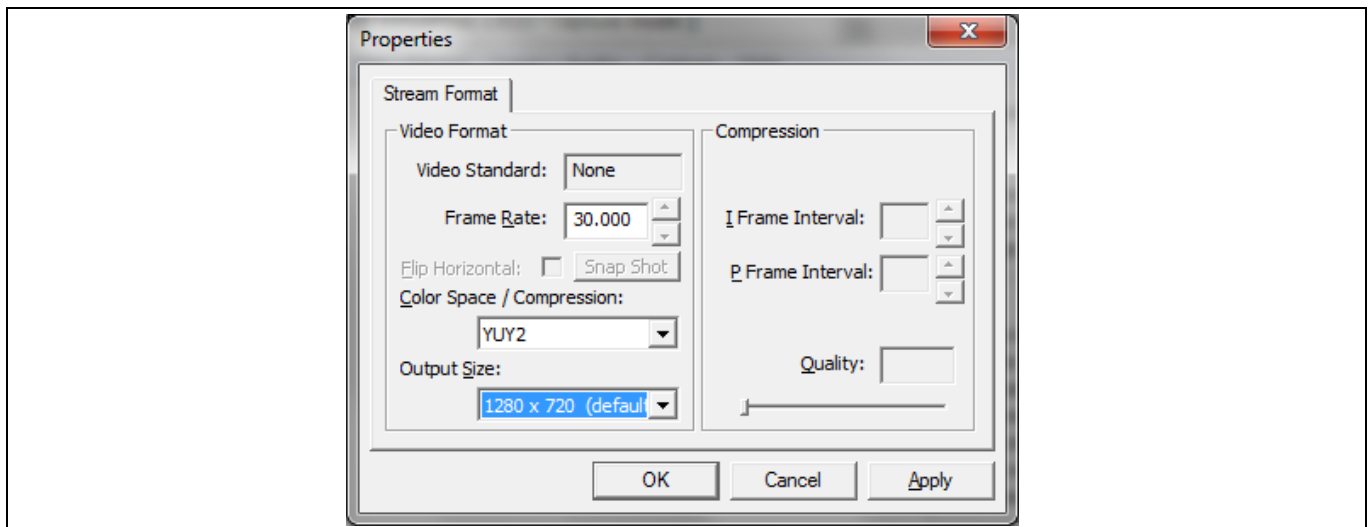

- 8. You can also use **Video > Levels** to change the brightness (change slider position to change value) or other supported control commands. Find additional control commands under **Video > Capture Filter**.

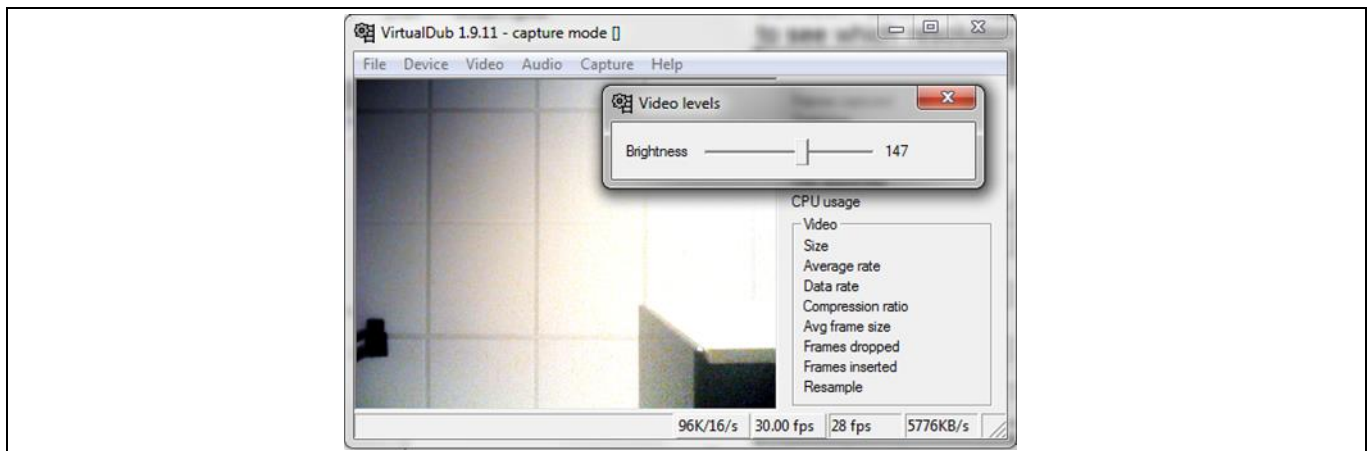

*Note: Enabling video controls like exposure, sharpness, and so on, requires a Non-Disclosure Agreement (NDA) with ON Semiconductor. Contact Local FAE/Sales representative with the executed NDA for assistance to enable these additional controls from the EZ-USB™ FX3 firmware.*

## Troubleshooting

### 8 Troubleshooting

#### 8.1 Black screen or incorrect color visible in the host application

1. Ensure to use release build of the firmware since it is optimized for performance.
2. Enable “DEBUG\_PRINT\_FRAME\_COUNT” switch in the *uvc.h* file to find out whether EZ-USB™ FX3 is streaming images. This switch will enable UART prints for frame counts. On SuperSpeed explorer kit, UART is always available through the on-board integrated debugger. Open HyperTerminal, Tera Term, or another utility that gives access to the COM port on PC.

Set the UART configuration as follows before starting transfers: **115200 baud, no parity, 1 stop bit, no flow control, and 8-bit data**. This should be sufficient to capture debug prints. If you do not see the incremental frame counter in the PC terminal program, there is probably a problem with the interface between EZ-USB™ FX3 and the image sensor (GPIF or sensor control/initialization).

3. If you see the prints of the incremental frame counter in the PC terminal program, the image data that is being sent out needs to be verified. A USB trace can show the amount of data being transferred per frame.
4. To check the total amount of data being sent out per frame, find the data packets that have the end-of-frame bit set in the header. (The second byte of the header is either 0x8E or 0x8F for the end-of-frame transfer). The total image data transferred in a frame (not including the UVC header) should be: **width \* height \* pixel size** in bytes. If this is not the amount from the USB trace, there is an issue with the image sensor setting or with the GPIF interface.

*Note: You may use hardware-based USB protocol analyzer tools like LeCroy, Ellisys or Beagle or software-based tools like Wireshark, USBlyzer for capturing and analyzing USB traces.*

5. Check if DMA reset events are being observed in the debug prints. If yes, check if the data is sent correctly from the image sensor.
6. Verify if the frame valid (FV) and line valid (LV) signals from the image sensor are behaving correctly per the chosen resolution and frame rate. Refer to **GPIF II image sensor interface** section to read about Image sensor interface requirements.
7. Check if the frame size received by EZ-USB™ FX3 is the same as the frame size reported in the USB descriptor for the particular resolution.
8. Check if the video probe and commit control parameters **dwMaxPayloadTransferSize** and **dwMaxVideoFrameSize** are set correctly for the selected resolution.
9. Check if partial DMA buffer size observed is a multiple of 4, because **CyU3PDmaSocketSetWrapUp** can commit data only in multiples of 4.
10. Check if the counters used in the GPIF state machine are configured correctly.
11. Verify if the video format GUID (guidFormat) is correctly set in the format descriptor and is supported by the host OS's UVC driver.
12. If the total amount of image data is correct and a host application still does not show any images, try on a different host computer.
13. See [Debug UVC application firmware in EZ-USB™ FX3 – KBA226722](#).

#### 8.2 Reduced frames per second observed in the host application

1. Verify if the frame valid (FV) and line valid (LV) signals from the image sensor are behaving correctly per the chosen resolution and frame rate.

# How to implement an image sensor interface using EZ-USB™ FX3 in a USB Video Class (UVC) framework

---



## Troubleshooting

2. Check if commit buffer failures are observed in UART debug prints. See [Handling commit buffer failures occurred during video transfers using EZ-USB™ FX3 – KBA231382](#) for details on how to handle these failures.
3. Check if the vertical blanking time is greater than 200  $\mu$ s.

If the problems persist, see similar cases in [Cypress Developer Community](#).

## Connecting two image sensors

### 9 Connecting two image sensors

Host applications, such as 3D imaging or motion tracking, require EZ-USB™ FX3 to stream simultaneous video data from two image sensors. If the sensors are different, an FPGA must be inserted between the image sensor modules and EZ-USB™ FX3 to reconcile formats and synthesize a single video data channel. Such a setup with two different image sensors is beyond the scope of this application note.

A more practical approach uses identical image sensors. This approach is detailed in this section.

**Figure 52** shows the connection details. The green blocks are inside the GPIF II and the red block is a part of an EZ-USB™ FX3 low-bandwidth peripheral (I<sup>2</sup>C/GPIO). The idea is to synchronize the two sensors to achieve identical frame timing and have the GPIF II simultaneously input each of their 8-bit video streams on a 16-bit data bus.

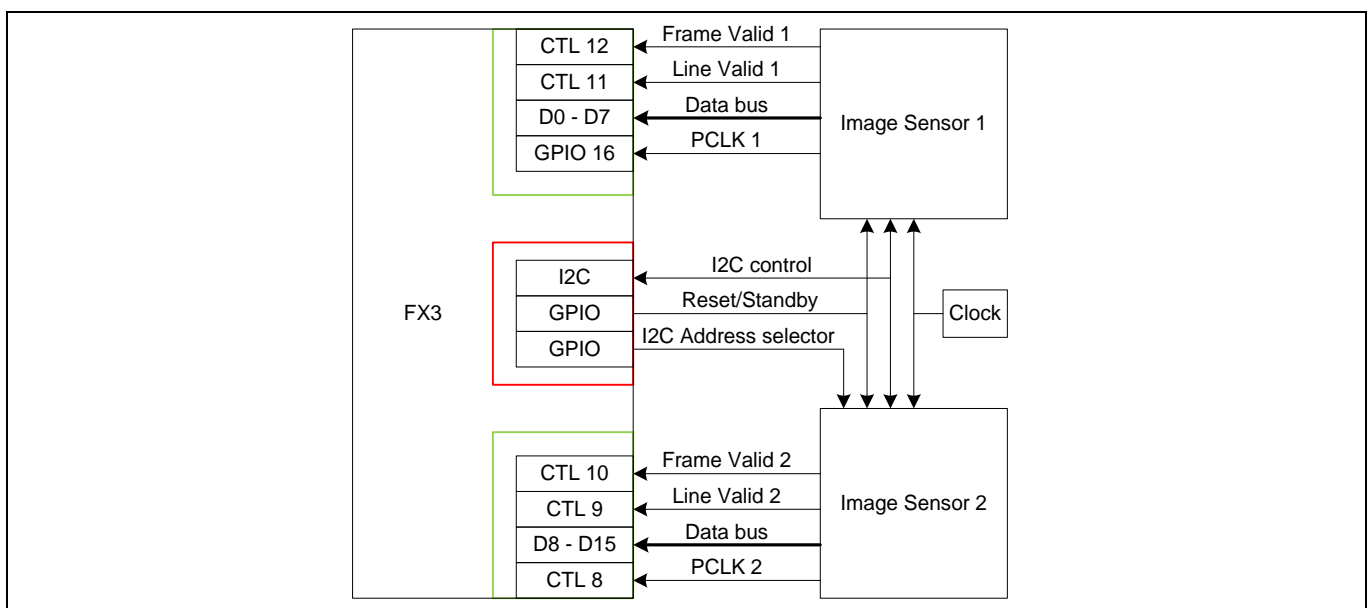

**Figure 52 Two identical image sensors connected to EZ-USB™ FX3**

**Figure 52** makes assumptions about the two image sensors:

- The bus width of each image sensor is 8 bits, making the GPIF II bus width 16 bits.
- The two image sensors are synchronized. This means that both image sensors use the same clock, LV and FV transitions, and pixel timing. In other words, frames from both image sensors could be exactly overlaid. Some image sensors have an external trigger input that can be used to synchronize two video streams. Other image sensors may use a different synchronization method. The applicable sensor datasheet gives details.
- Both image sensors use I<sup>2</sup>C for configuration. The image sensor used in this application note requires I<sup>2</sup>C control registers to be written at exactly the same time to achieve synchronization between the image sensor modules. This is accomplished by controlling the I<sup>2</sup>C address of one of the sensors using EZ-USB™ FX3 GPIO pins. EZ-USB™ FX3 configures both image sensors simultaneously using I<sup>2</sup>C writes. EZ-USB™ FX3 reads from individual sensors by switching to a different I<sup>2</sup>C address on the image sensor with the configurable address pins.
- Each sensor's Reset signals should be driven by the same EZ-USB™ FX3 GPIO output pin. Similarly, each sensor's standby pin, if present, should share another EZ-USB™ FX3 GPIO output pin.



## Connecting two image sensors

- Automatic configurations are disabled on the image sensors. For example, features such as auto exposure, auto gain, and auto white balance are turned OFF on both sensors. Turning them OFF ensures that the integration plus any image processing on the image sensors will take the same time. The result is that frames from both sensors are output from the image sensor simultaneously.

As shown in the connection diagram, frame valid 2, line valid 2, and PCLK 2 signals are connected to EZ-USB™ FX3, but they are not utilized by the GPIF II block because the image sensors are assumed to be synchronized. These signals are connected to EZ-USB™ FX3 so it can monitor the signals to check the accuracy of the synchronization between the image sensors during debug and development.

## 9.1 Transferring the interleaved image over UVC

The UVC specification cannot discern how many image sensors are used in a transmitted image. It deals only with one set of image parameters: frame width and height and total number of bytes per frame. To accommodate multiple image sensors, the UVC driver must read descriptors that have been modified so that the driver can perform and pass internal consistency checks. If these consistency checks fail, the UVC driver cannot pass image data to the host application and the application fails. The descriptors need to be modified so that the extra frame is accounted for in a manner that looks like a single image sensor to the UVC driver.

Two examples illustrate how this is done.

### 9.1.1 Example 1: Two 640 x 480 monochrome sensors

Two image sensors provide 640 x 480 monochrome (1 byte per pixel) data. EZ-USB™ FX3 simultaneously receives two complete images per frame, as shown in [Figure 53](#).

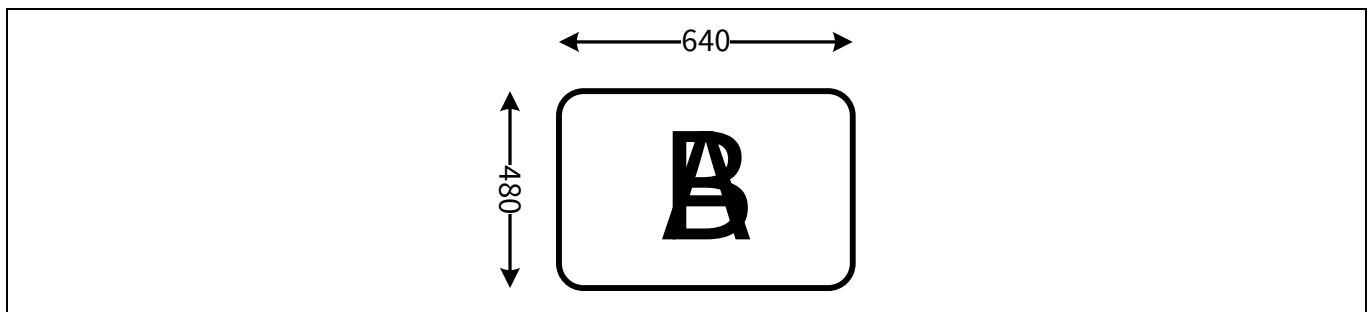

**Figure 53** What EZ-USB™ FX3 receives from two image sensors

The descriptors still report a 640 x 480 image size. The doubled data size is accommodated by placing the A image into the Y data and the B image into the U and V data.

The bytes per frame can be calculated as:

$$\text{Bytes per frame} = \text{Bytes per pixel} \times \text{Number of image sensors} \times \text{Resolution}$$

Where:

$$\text{Resolution} = \text{Width in pixels} \times \text{Height in pixels}$$

For this example:

$$\text{Bytes per frame} = 1 \times 2 \times 640 \times 480 = 614,400 \text{ bytes}$$

## Connecting two image sensors

### 9.1.2 Example 2: Two 640 x 480 color sensors

Consider two color sensors that send YUY2 data with 640 x 480 resolution. EZ-USB™ FX3 receives two complete color images per frame (**Figure 54**).

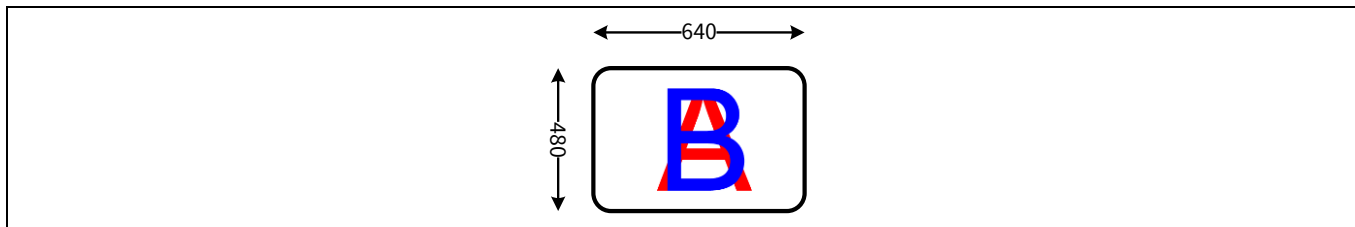

**Figure 54** EZ-USB™ FX3 receives two color images

The only difference from example 1 is that each pixel in the YUY2 format now uses two bytes instead of one. To accommodate the pixel doubling, the reported image size is doubled (**Figure 55**).

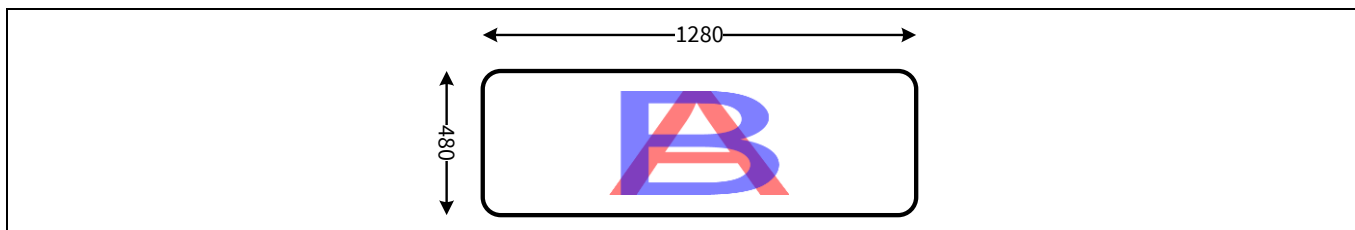

**Figure 55** Reported image size

Because each pixel now occupies two bytes, the data per frame is:

$$\text{Bytes per frame} = 2 \times 2 \times 640 \times 480 = 1,228,800 \text{ bytes}$$

Note that any arbitrary frame width and height could be reported as long as they reflect the pixel doubling. Doubling only one dimension simplifies the downstream math. Doubling the width, as opposed to the height, has the advantage of overlaying the vertical lines, which simplifies application image processing.

These descriptor modifications allow double images to be transported from the image sensors to the host application in an interleaved fashion: Any two consecutive bytes are from different image sensors.

The above modifications pass the UVC driver consistency checks, allowing the driver to pass the video data to host applications. The video streamed in this manner is not meant to be comprehended when viewed directly. You can use a standard UVC host application to perform a sanity check of the implementation. However, the images are streamed in a non-standard manner, so the applications will not display them correctly. A custom application needs to be built to separate these images and to view and calculate useful information from the interleaved video.

## 9.2 Firmware modification checklist to add new video format to the current project

As a summary, when modifying the given example firmware to add a new video format, use the following steps to ensure that all of the required changes have been made:

1. Update the Hi-Speed and SuperSpeed USB configuration descriptors by adding the new format descriptor. See USB video payload specification documents for details on the format descriptor parameters.
2. Update the `bNumFormats` and `wTotalLength` fields in the class-specific interface input header descriptor

## Connecting two image sensors

3. For details on adding a new resolution, see [Section 9.3](#).

### 9.3 Firmware modification checklist to add new video resolution to the current project

As a summary, when modifying the given example firmware to add a new resolution, use the following steps to ensure that all of the required changes have been made:

1. Update the High-speed and SuperSpeed USB configuration descriptors by adding the new frame descriptor to the available format descriptor. The new frame descriptor should reflect the following details of the new Video resolution: frame index, resolution width, resolution height, frame rate, maximum bit rate, minimum bit rate and width-to-height ratio. Update the Hi-Speed and SuperSpeed USB configuration descriptor lengths and Video Streaming Input Header descriptor length to include all Video frame descriptors supported.
2. Add PROBE/COMMIT control structure for the video frame resolution added. Handle the SET\_CUR and GET\_CUR requests for the newly added video frame resolution.
3. Add sensor control commands to set the newly added video frame resolution.

### 9.4 Checklist for firmware modification to support a new sensor

As a summary, when modifying the given example firmware to support a new sensor, use the following steps to ensure that all of the required changes have been made:

1. Image sensor control: The example has reference I2C code as the control interface to send commands to image sensor. This may need modifications or may require a different kind of interface which is supported by the new image sensor.
2. Additional code to control the GPIO that acts as an image sensor selector for the control interface. When EZ-USB™ FX3 writes to the sensors (refer [Figure 52](#)) used in this application note, it is a multicast message to both image sensors, but FX3 requires exclusive access when it reads the I2C registers from the image sensors.
3. Additional code to control the GPIO that controls the standby or low-power mode of the image sensors.
4. Changes to the UVC-specific High-speed and SuperSpeed USB configuration descriptors for frame and format. This is to report the format of the video supported and frame index, resolution width, resolution height, frame rate, maximum bit rate, minimum bit rate and width-to-height ratio of all the video frame resolutions supported.
5. Update the Hi-Speed and SuperSpeed USB configuration descriptor lengths and Video Streaming Input Header descriptor length to include all video frame descriptors added.
6. Add PROBE/COMMIT control structure for each video resolution supported. Handle the SET\_CUR and GET\_CUR requests for all the video frame resolutions.
7. Changes to the GPIF II descriptor to increase the bus width and to update the counter limits according to the bus width. These changes are made in the GPIF II designer to generate the header file. Remember to copy this newly generated file in your project to ensure that the changes take effect.

## Summary

### 10 Summary

This application note describes how an image sensor conforming to the USB Video Class can be implemented using Infineon EZ-USB™ FX3. Specifically, it shows:

- How the host application and driver interact with a UVC device
- How the UVC device manages UVC-specific requests
- How to program an EZ-USB™ FX3 interface using GPIF II designer to receive data from typical image sensors
- How to display video streams and change camera properties in a host application
- How to add a USB interface to the UVC device for debugging purposes
- How to find host applications available on different platforms, including an open-source host application project
- How to connect multiple image sensors, synchronize them externally, and stream from them simultaneously over the UVC
- How to troubleshoot and debug the EZ-USB™ FX3 firmware, if required.

# How to implement an image sensor interface using EZ-USB™ FX3 in a USB Video Class (UVC) framework



## Appendix A: Hardware setup details for EZ-USB™ FX3 DVK (CYUSB3KIT-001)

### 11 Appendix A: Hardware setup details for EZ-USB™ FX3 DVK (CYUSB3KIT-001)

#### 11.1 EZ-USB™ FX3 DVK board setup

Follow these steps to prepare the board for testing the video application:

1. Configure the jumpers on the EZ-USB™ FX3 DVK board as shown in **Figure 56**. Do not load the jumpers that are not highlighted in the figure.

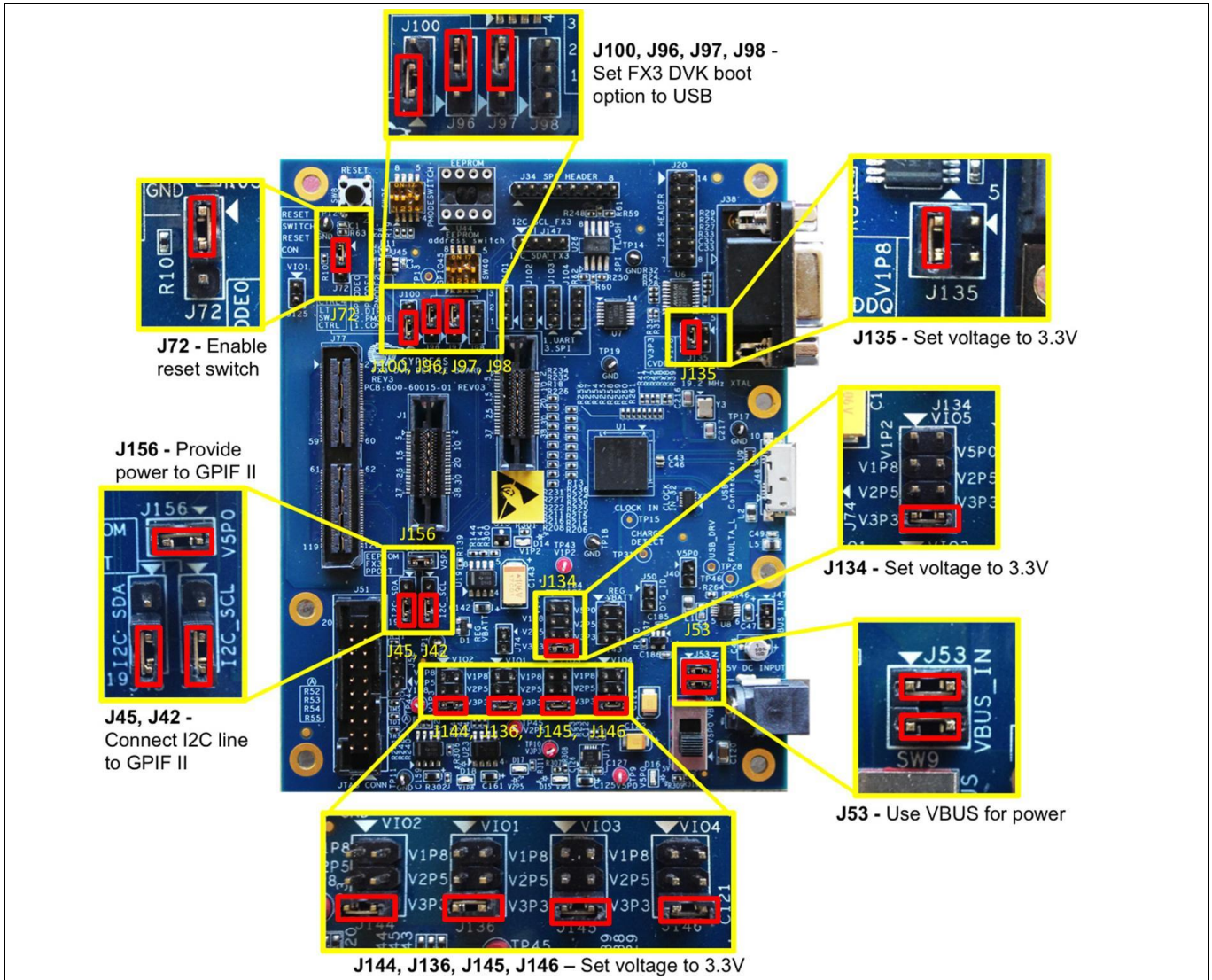

**Figure 56** EZ-USB™ FX3 DVK jumpers

2. Plug the Aptina image sensor interconnect board (CYUSB3ACC-004) onto EZ-USB™ FX3 DVK J77. The connector types on the interconnect board are unique, and the sockets are keyed to fit only in the correct orientation.
3. Connect the Aptina image sensor module to the interconnect board. **Figure 57** shows the three-board assembly.



# How to implement an image sensor interface using EZ-USB™ FX3 in a USB Video Class (UVC) framework



## Appendix A: Hardware setup details for EZ-USB™ FX3 DVK (CYUSB3KIT-001)

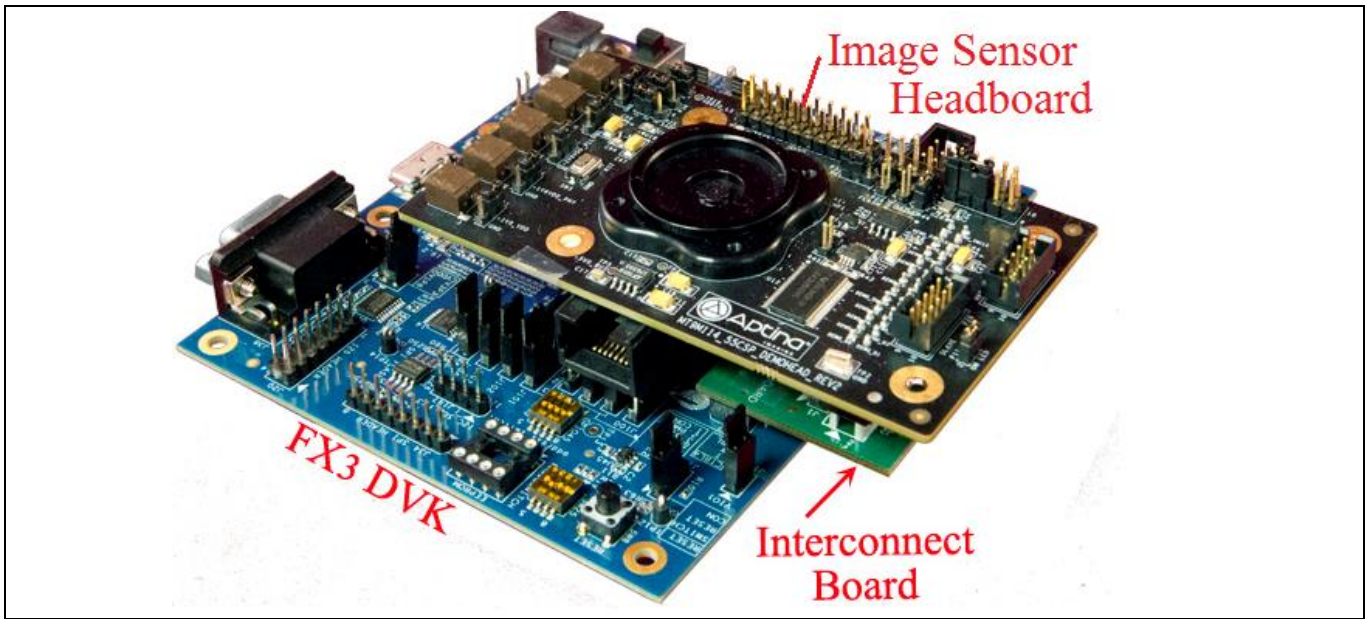

**Figure 57** The 3-board 720p camera assembly

4. Plug the EZ-USB™ FX3 DVK board into the USB port of the computer using the USB 3.0 cable provided with the DVK.
5. Load the firmware into the board using the Control Center application provided as part of the EZ-USB™ FX3 SDK. The firmware source and pre-built image is provided in [AN75779.zip](#). For detailed instructions, see [AN75705 - Getting Started with EZ-USB™ FX3](#). Here are brief instructions:

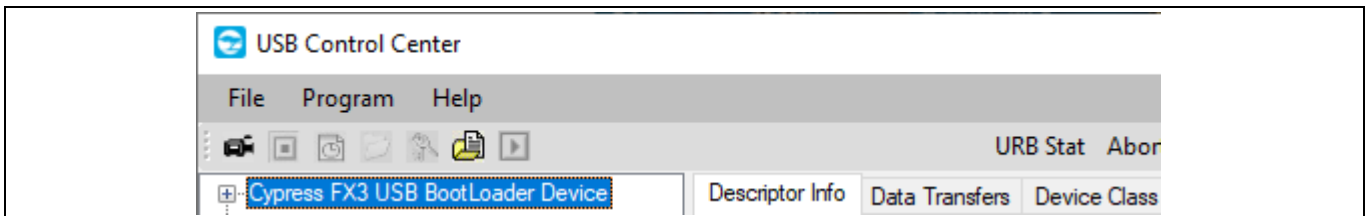

**Figure 58** FX3 enumerates as a bootloader

- a) Start the Control Center application. When you plug in the EZ-USB™ FX3 DVK, it will be recognized as Infineon EZ-USB™ FX3 USB Bootloader Device ([Figure 58](#)).
- b) Select **Program > FX3 > RAM** and navigate to the `cyfx_uvc_an75779.img` file provided with the attachment to this application note ([Figure 59](#)). Note that the device will lose the loaded firmware and re-enumerate as Infineon EZ-USB™ FX3 USB Bootloader Device if it is power-cycled after programming.

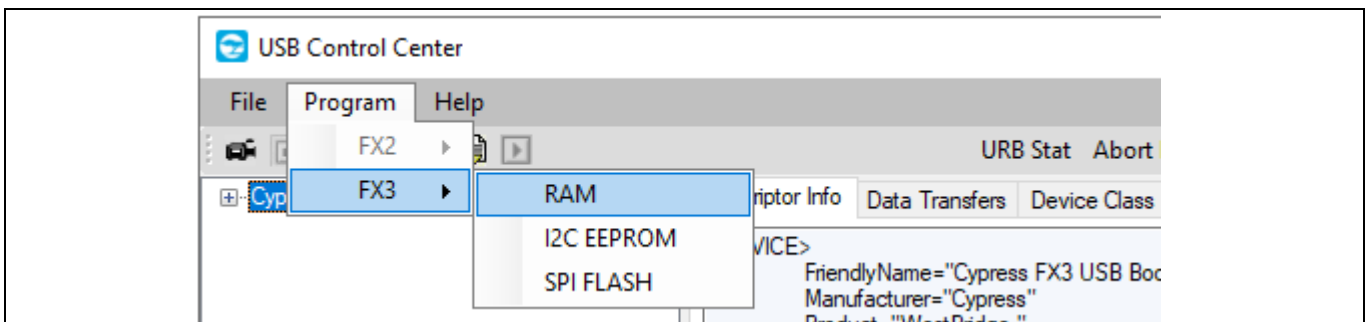

**Figure 59** Loading code into FX3 RAM

# How to implement an image sensor interface using EZ-USB™ FX3 in a USB Video Class (UVC) framework



## Appendix A: Hardware setup details for EZ-USB™ FX3 DVK (CYUSB3KIT-001)

- c) Control Center application will show the status of programming on the status bar. On successful programming, the device will also disappear from the Control Center device list as the device will now enumerate as a UVC Class device. The device can be seen in Windows Device Manager under Cameras or Imaging Devices type (**Figure 60**).

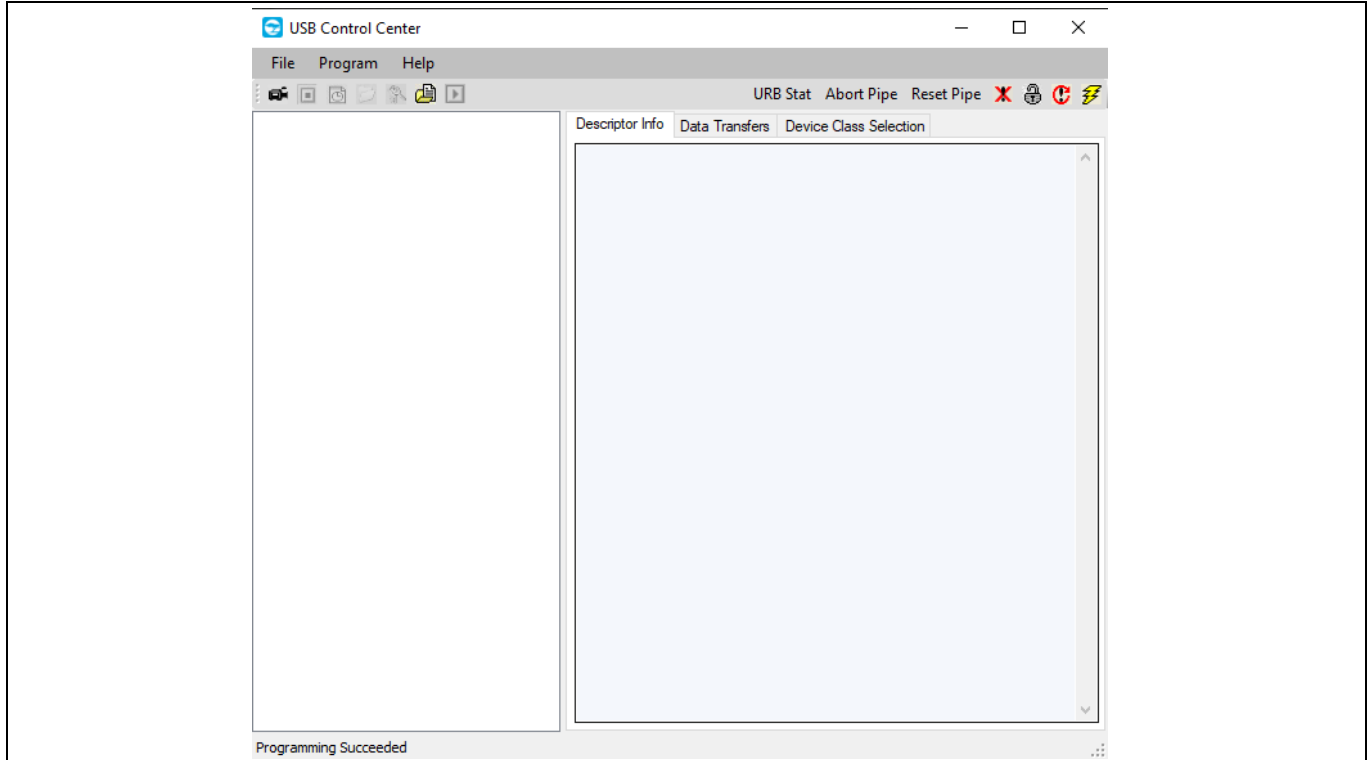

**Figure 60** Programming succeeded message displayed on status bar

# How to implement an image sensor interface using EZ-USB™ FX3 in a USB Video Class (UVC) framework



## Appendix B: Hardware setup details for EZ-USB™ FX3 explorer kit and Aptina image sensor interconnect board (CYUSB3ACC-004)

### 12 Appendix B: Hardware setup details for EZ-USB™ FX3 explorer kit and Aptina image sensor interconnect board (CYUSB3ACC-004)

#### 12.1 Hardware setup

1. Close jumpers J2, J3, and J4 and open jumper J5 on EZ-USB™ FX3 explorer kit.
2. Assemble the SuperSpeed explorer kit, Interconnect board, and the Aptina image sensor board as instructed in the Aptina interconnect board quick start guide. **Figure 61** shows the assembly.

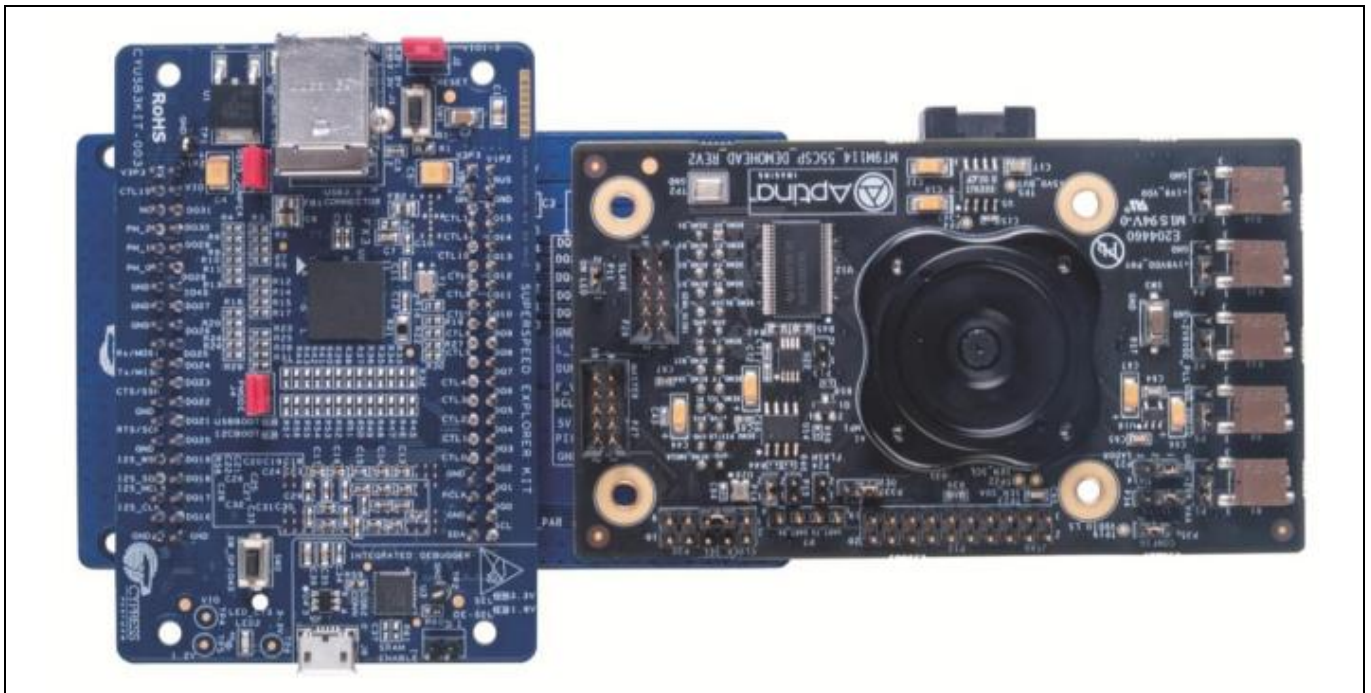

**Figure 61 SuperSpeed explorer kit, Aptina interconnect, and Aptina sensor board assembly**

3. Plug the EZ-USB™ FX3 explorer kit board into the USB port of the computer using the USB 3.0 cable provided with the kit.
4. Load the firmware onto the board using the Control Center application provided as part of the EZ-USB™ FX3 SDK. The firmware source and pre-built image is provided in [AN75779.zip](#). For detailed instructions, see [AN75705 - Getting Started with EZ-USB™ FX3](#). Here are brief instructions:

Start the Control Center application. When you plug in the EZ-USB™ FX3 explorer board, it will be recognized as Infineon EZ-USB™ FX3 USB Bootloader Device (**Figure 62**).

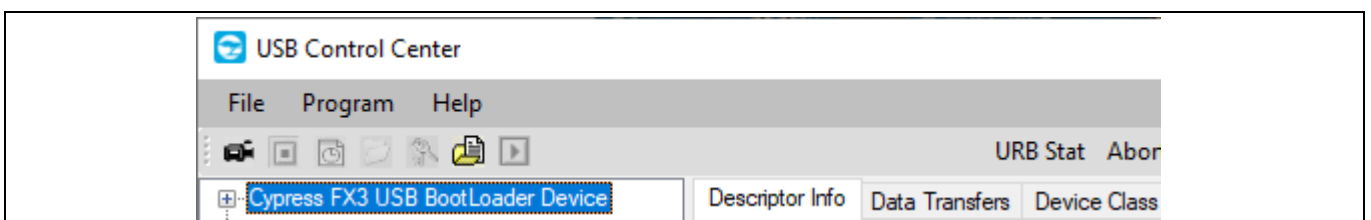

**Figure 62 EZ-USB™ FX3 enumerates as a bootloader**



# How to implement an image sensor interface using EZ-USB™ FX3 in a USB Video Class (UVC) framework

## Appendix B: Hardware setup details for EZ-USB™ FX3 explorer kit and Aptina image sensor interconnect board (CYUSB3ACC-004)

Select **Program > FX3 > RAM** and navigate to the *cyfx\_uvc\_an75779.img* file provided with the attachment to this application note (**Figure 63**). Note that the device will lose the loaded firmware and re-enumerate as Infineon EZ-USB™ FX3 USB Bootloader Device if it is power-cycled after programming.

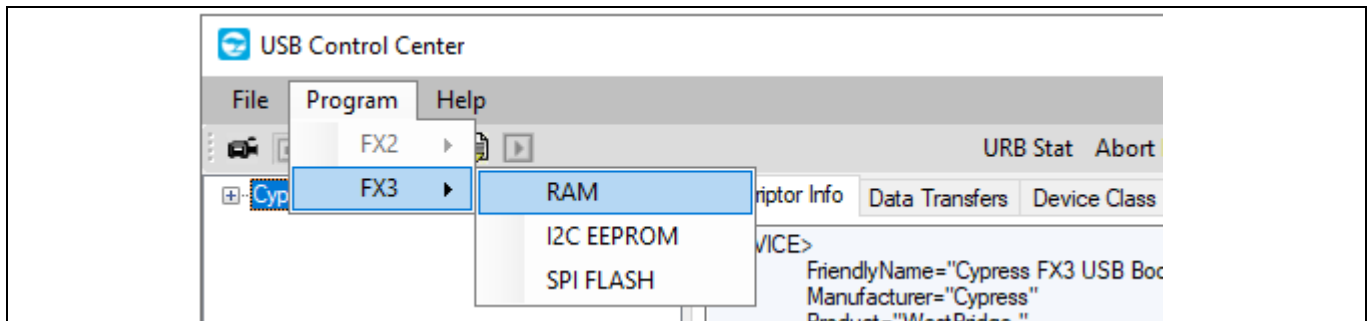

**Figure 63 Loading code into EZ-USB™ FX3 RAM**

Control Center application will show the status of programming on the status bar. On successful programming, the device will also disappear from the Control Center device list as the device will now enumerate as a UVC Class device. The device can be seen in Windows Device Manager under Cameras or Imaging Devices type (**Figure 64**).

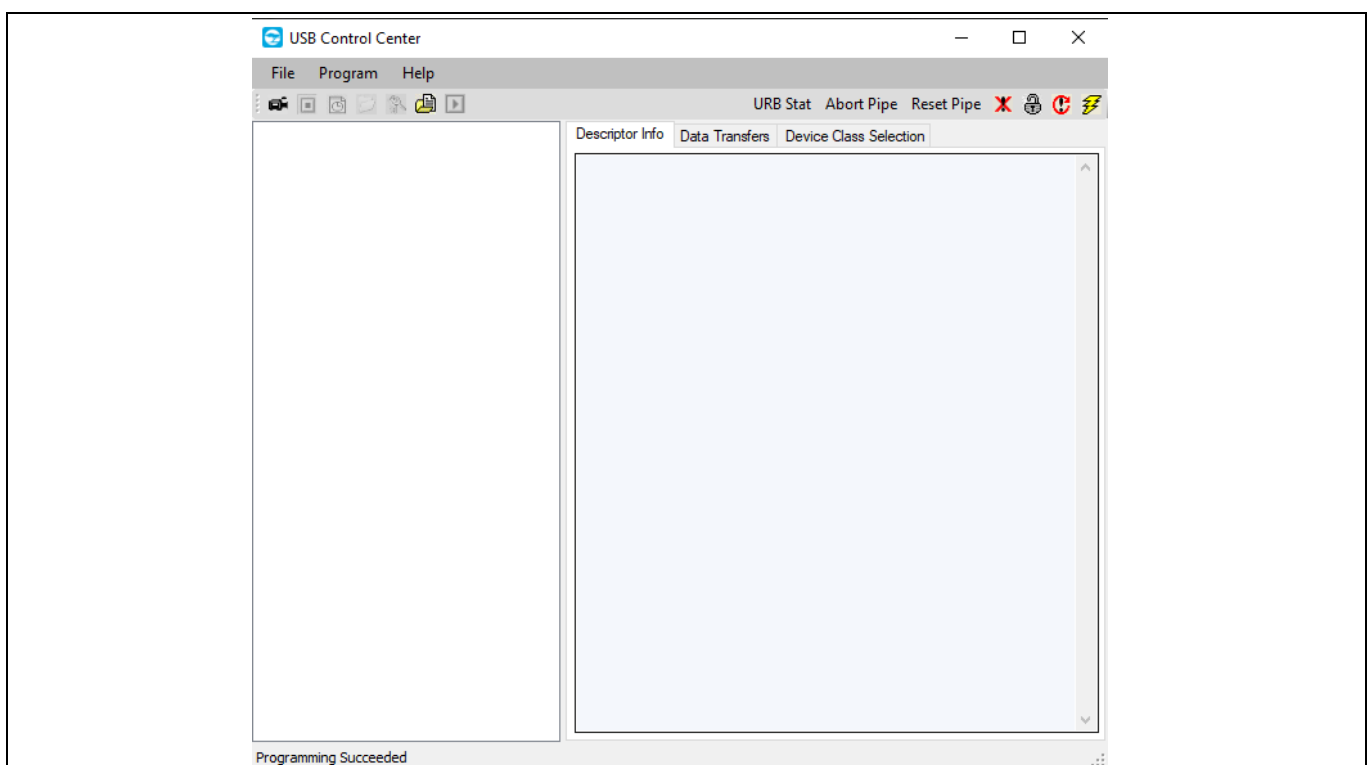

**Figure 64 Programming succeeded message displayed on status bar**

# How to implement an image sensor interface using EZ-USB™ FX3 in a USB Video Class (UVC) framework

---



## References

## References

[1] [AN75705](#)

[2] [AN90369](#)

## Revision history

### Revision history

Document version	Date of release	Description of changes
**	2012-04-19	New Application Note
*A	2012-06-14	<p>Changed application note title to match the scope of the new version of application note</p> <p>Added firmware project</p> <p>Added explanation of the firmware project</p> <p>Added the UVC application related details,</p> <p>Revised the functional block diagram</p> <p>Moved the steps to generate the GPIF II descriptor using the GPIF II Designer tool to Appendix A</p> <p>Added section in Appendix to show users how to modify a the given GPIF II -Designer project</p> <p>Clarified certain topics with explicit information</p> <p>Updated the all the links in the document to point to the correct locations within and outside the document</p> <p>Removed references to AN75310</p> <p>Removed references to the Slave FIFO application note</p>
*B	2013-03-20	<p>Updated application note title</p> <p>Updated the Software Version required</p> <p>Updated the Abstract with information on newly added features</p> <p>Updated TOC</p> <p>Added more description on how UVC application works</p> <p>Added general block diagram of UVC class requests</p> <p>Modified the description of the file structure based on the new structure in the associated project for ease of use</p> <p>Added a section on USB descriptors for UVC application</p> <p>Added details section on UVC class requests</p> <p>Added description of sample control requests (brightness and PTZ) included as new features in the updated associated project</p> <p>Added a section on the UVC streaming requests</p> <p>Added a section on the UVC video format and UVC header insertion</p> <p>Updated the firmware application description section with appropriate content to reflect the changes in the associated firmware project</p> <p>Added a section describing an optional debug interface implemented as a new feature and documentation on how to use this new interface</p> <p>Added a section on the hardware setup instructions</p> <p>Added a section on host applications available in market for viewing video over UVC</p> <p>Added a section on basic troubleshooting</p> <p>Updated the GPIF II state machine design steps in the Appendix A to accommodate the updated state machine used in the associated project</p>

# How to implement an image sensor interface using EZ-USB™ FX3 in a USB Video Class (UVC) framework



## Revision history

Document version	Date of release	Description of changes
*C	2013-06-27	<p>Updated the abstract to include reference to two image sensor interface</p> <p>Added section to explain how to connect two image sensors</p> <p>Added section on how to transfer data with two image sensors connected</p> <p>Added section called Firmware Modification Checklist</p> <p>To improve quality of graphics, replaced Hardware Setup screen shot on page 20.</p>
*D	2013-09-27	Rewrite and overhaul of application note.
*E	2015-03-31	<p>Updated the Software Version “FX3 SDK1.2.3” to “FX3 SDK1.3.3”, in page 1.</p> <p>Updated Related Application Notes in page 1.</p> <p>Added reference to the consolidated list of USB SuperSpeed Code Examples in Abstract, in page 1.</p> <p>Added a Note in <b>Introduction</b>.</p> <p>Updated the Note in <b>Video data format: YUY2</b>.</p> <p>Updated Step 4 in <b>Draw the GPIF II state machine</b>.</p> <p>Updated <b>Hardware setup</b>.</p> <p>Updated <b>Hardware</b> .</p> <p>Updated <b>SuperSpeed explorer kit board setup</b>: Removed “Figure 47. EZ-USB™ FX3 DVK Jumpers” and “Figure 48. The Three Board 720P Camera Assembly”.</p> <p>Updated the precompiled code image file hyperlink in <b>Running the demo</b>.</p> <p>Added Step 1 and updated Step 2 in <b>Troubleshooting</b>.</p> <p>Added subsection <b>Firmware modification checklist to add new video format to the current project</b>.</p> <p>Updated <b>Checklist for firmware modification to support a new sensor</b>.</p> <p>Added <b>Appendix A: Hardware setup details for EZ-USB™ FX3 DVK (CYUSB3KIT-001)</b></p> <p>Added <b>Figure 56</b> through <b>Figure 59</b>.</p> <p>Updated to new template.</p>
*F	2015-10-08	Updated attached Associated Project.
*G	2016-03-16	<p>Removed the NDA requirement for sharing sensor configuration file. MT9M114 sensor is now open source.</p> <p>Added a note on UVC Isoc bandwidth limitation in USB 3.0 SuperSpeed mode.</p> <p>Updated the steps to create GPIF State Machine.</p> <p>Added a reference to FX2G2, USB 2.0 part from FX3 family.</p> <p>Updated template</p>
*H	2017-04-11	Updated logo and copyright

# How to implement an image sensor interface using EZ-USB™ FX3 in a USB Video Class (UVC) framework



## Revision history

Document version	Date of release	Description of changes
*I	2017-07-12	Updated attached associated project and Firmware design section in the App note. Updated note on UVC Isoc bandwidth limitation in USB 3.0 SuperSpeed mode. Added a note on Synchronous and Asynchronous video control transfers. Added a note on source code of few Windows host applications.
*J	2017-10-06	Added UVC extension unit in the attached Associated project
*K	2019-07-22	Added details on Semiconductor Image Sensor Interconnect Board Added <b>Appendix B: Hardware setup details for EZ-USB™ FX3 explorer kit and Aptina image sensor interconnect board (CYUSB3ACC-004)</b>
*L	2021-10-27	Added links to relevant KBAs Added details on Still Image capture Added more details in <b>Troubleshooting</b> section Updated to Infineon template

#### Trademarks

All referenced product or service names and trademarks are the property of their respective owners.

**Edition 2021-10-27**

**Published by**

**Infineon Technologies AG**

**81726 Munich, Germany**

**© 2021 Infineon Technologies AG.**

**All Rights Reserved.**

**Do you have a question about this document?**

**Go to [www.cypress.com/support](http://www.cypress.com/support)**

**Document reference**

**001-75779 Rev. \*L**

#### IMPORTANT NOTICE

The information contained in this application note is given as a hint for the implementation of the product only and shall in no event be regarded as a description or warranty of a certain functionality, condition or quality of the product. Before implementation of the product, the recipient of this application note must verify any function and other technical information given herein in the real application. Infineon Technologies hereby disclaims any and all warranties and liabilities of any kind (including without limitation warranties of non-infringement of intellectual property rights of any third party) with respect to any and all information given in this application note.

The data contained in this document is exclusively intended for technically trained staff. It is the responsibility of customer's technical departments to evaluate the suitability of the product for the intended application and the completeness of the product information given in this document with respect to such application.

For further information on the product, technology, delivery terms and conditions and prices please contact your nearest Infineon Technologies office ([www.infineon.com](http://www.infineon.com)).

#### WARNINGS

Due to technical requirements products may contain dangerous substances. For information on the types in question please contact your nearest Infineon Technologies office.

Except as otherwise explicitly approved by Infineon Technologies in a written document signed by authorized representatives of Infineon Technologies, Infineon Technologies' products may not be used in any applications where a failure of the product or any consequences of the use thereof can reasonably be expected to result in personal injury.