

Low Noise SiGe: BGA7H1N6

Single Band LTE LNA Using BGA7H1N6 Supporting Band-7 (2620- 2690 MHz)

Application Note AN406

About this document

Scope and purpose

This application note describes Infineon's Low Noise SiGe: BGA7H1N6 as Low Noise Amplifier (LNA) for LTE Single Band-7 applications.

1. This application note presents the measurement and simulation results of a LNA design from 2620 – 2690 MHz for LTE Single Band application purposes.
2. The LNA design presented in this application notes uses Infineon BGA7H1N6 Low Noise Amplifier.
3. The LNA is to be used in many reference designs of chipset vendors but can also be found in customized solutions to compensate losses due to long PCB-traces from the antenna to the transceiver or improve the own system performance beyond the standard.
4. The LNA desing shown in this application note is to increase the data rate and sensitivity of LTE and LTE-Advanced capable mobile phones and data cards.
5. Key performance paramerters achieved (at 2655 MHz)
 - a. Noise figure = 0.78 dB
 - b. Gain = 12.4 dB
 - c. Input return loss = 12.1 dB
 - d. Output return loss =23.2 dB
 - e. Output P1dB = 7.5 dBm

Table of Contents

Table of Contents	2
List of Figures	3
1 Introduction	5
1.1 Introduction About 3G and 4G	5
1.2 Applications.....	7
1.3 Infineon LNAs for 3G, 4G LTE and LTE-A Applications	8
2 BGA7H1N6 Overview	11
2.1 Features	11
2.2 Key Applications of BGA7H1N6.....	11
2.3 Description	11
3 Application Circuit and Performance Overview	13
3.1 Summary of Measurement Results.....	13
3.2 BGA7H1N6 as Low Noise Amplifier for LTE Single Band-7 (2620 – 2690 MHz) Application	15
3.3 Schematics and Bill-of-Materials.....	16
4 Measurement Graphs	17
5 Evaluation Board and Layout Information	30
6 Authors	31
7 Reference	31

List of Figures

Figure 1	Example of Application Diagram of RF Front-End for 3G and 4G Systems.....	7
Figure 2	BGA7H1N6 in TSNP-6-2	11
Figure 1	Equivalent Circuit of BGA7H1N6	12
Figure 2	Package and pin connections of BGA7H1N6	12
Figure 3	Schematics of the BGA7H1N6 Application Circuit.....	16
Figure 4	Insertion Power Gain (Narrowband) of the BGA7H1N6 for LTE Band-7 at Vcc = 1.8 V	17
Figure 5	Insertion Power Gain (Wideband) of the BGA7H1N6 for LTE Band-7 at Vcc = 1.8 V	17
Figure 6	Insertion Power Gain (Narrowband) of the BGA7H1N6 for LTE Band-7 at Vcc = 2.8 V	18
Figure 7	Insertion Power Gain (Wideband) of the BGA7H1N6 for LTE Band-7 at Vcc = 2.8 V	18
Figure 8	Noise Figure of the BGA7H1N6 for LTE Band-7 Application at Vcc = 1.8 V	19
Figure 9	Noise Figure of the BGA7H1N6 for LTE Band-7 Application at Vcc = 2.8 V	19
Figure 10	Input Matching of the BGA7H1N6 for LTE Band-7 Application at Vcc = 1.8 V	20
Figure 11	Input Matching of the BGA7H1N6 for LTE Band-7 Application at Vcc = 2.8 V	20
Figure 12	Input Matching (Smith Chart) of the BGA7H1N6 for LTE Band-7 Application at Vcc = 1.8 V	21
Figure 13	Input Matching (Smith Chart) of the BGA7H1N6 for LTE Band-7 Application at Vcc = 2.8 V	21
Figure 14	Output Matching of the BGA7H1N6 for LTE Band-7 Application at Vcc = 1.8 V	22
Figure 15	Output Matching of the BGA7H1N6 for LTE Band-7 Application at Vcc = 2.8 V	22
Figure 16	Output Matching (Smith Chart) of the BGA7H1N6 for LTE Band-7 Application at Vcc = 1.8 V	23
Figure 17	Output Matching (Smith Chart) of the BGA7H1N6 for LTE Band-7 Application at Vcc = 2.8 V	23
Figure 18	Reverse Isolation of the BGA7H1N6 for LTE Band-7 Application at Vcc = 1.8 V	24
Figure 19	Reverse Isolation of the BGA7H1N6 for LTE Band-7 Application at Vcc = 2.8 V	24
Figure 20	Stability K-factor of the BGA7H1N6 for LTE Band-7 Application at Vcc = 1.8 V	25
Figure 21	Stability K-factor of the BGA7H1N6 for LTE Band-7 Application at Vcc = 2.8 V	25
Figure 22	Stability Mu1-factor of the BGA7H1N6 for LTE Band-7 Application at Vcc = 1.8 V	26
Figure 23	Stability Mu1-factor of the BGA7H1N6 for LTE Band-7 Application at Vcc = 2.8 V	26
Figure 24	Stability Mu2-factor of the BGA7H1N6 for LTE Band-7 Application at Vcc = 1.8 V	27
Figure 25	Stability Mu2-factor of the BGA7H1N6 for LTE Band-7 Application at Vcc = 2.8 V	27
Figure 26	Input 1dB compression point of the BGA7H1N6 for LTE Band-7 Application.....	28
Figure 27	Input 3 rd interception point of the BGA7H1N6 for LTE Band-7 Application at Vcc=1.8 V	28
Figure 28	Input 3 rd interception point of the BGA7H1N6 for LTE Band-7 Application at Vcc=2.8 V	29
Figure 29	Photo of Evaluation Board (overview).....	30
Figure 30	Photo of Evaluation Board (detailed view)	30
Figure 31	PCB Layer Information	30

List of Tables

Table 1	LTE Band Assignment.....	5
Table 2	Infineon Product Portfolio of LNAs for 4G LTE and LTE-A Applications	9
Table 3	Infineon Product Portfolio of LNAs for 3G and 4G Applications	10
Table 4	Pin Assignment of BGA7H1N6.....	12
Table 5	Electrical Characteristics (at room temperature) for Band-7 (2620 – 2690 MHz), VCC = 1.8 V, VPON = 1.8 V	13

LTE LNA for Single Band-7 Application

List of Figures

Table 6	Electrical Characteristics (at room temperature)) for Band-7 (2620 – 2690 MHz), VCC = 2.8 V, VPON = 2.8 V	14
Table 7	Bill-of-Materials	16

1) The graphs are generated with the simulation program AWR Microwave Office®.

1 Introduction

1.1 Introduction About 3G and 4G

The mobile technologies for smartphones have seen tremendous growth in recent years. The data rate required from mobile devices has increased significantly over the evolution modern mobile technologies, starting from the first 3G/3.5G technologies (UMTS & WCDMA, HSPA & HSPA+) to the recently 4G LTE-Advanced (LTE-A). LTE-A can support data rates of up to 1 Gbps.

Advanced technologies such as diversity Multiple Input Multiple Output (MIMO) and Carrier Aggregation (CA) are adopted to achieve such higher data rate requirements. MIMO technology, commonly referred as the diversity path in smartphones, has attracted attention for the significant increase in data throughput and link range without additional bandwidth or increased transmit power. The technology supports scalable channel bandwidth, between 1.4 and 20 MHz. The ability of 4G LTE to support bandwidths up to 20 MHz and to have more spectral efficiency by using high order modulation methods like QAM-64 is of particular importance as the demand for higher wireless data speeds continues to grow fast. Carrier aggregation used in LTE-Advanced combines up to 5 carriers and widens bandwidths up to 100 MHz to increase the user rates, across FDD and TDD.

Countries all over the world have released various frequencies bands for the 4G applications. **Table 1** shows the band assignment for the LTE bands worldwide.

Table 1 LTE Band Assignment

Band No.	Band Definition	Uplink Frequency Range	Downlink Frequency Range	FDD/TDD System	Comment
1	Mid-Band	1920-1980 MHz	2110-2170 MHz	FDD	
2	Mid-Band	1850-1910 MHz	1930-1990 MHz	FDD	
3	Mid-Band	1710-1785 MHz	1805-1880 MHz	FDD	
4	Mid-Band	1710-1755 MHz	2110-2155 MHz	FDD	
5	Low-Band	824-849 MHz	869-894 MHz	FDD	
6	Low-Band	830-840 MHz	875-885 MHz	FDD	
7	High-Band	2500-2570 MHz	2620-2690 MHz	FDD	

LTE LNA for Single Band-7 Application

Introduction

Table 1 LTE Band Assignment

Band No.	Band Definition	Uplink Frequency Range	Downlink Frequency Range	FDD/TDD System	Comment
8	Low-Band	880-915 MHz	925-960 MHz	FDD	
9	Mid-Band	1749.9-1784.9 MHz	1844.9-1879.9 MHz	FDD	
10	Mid-Band	1710-1770 MHz	2110-2170 MHz	FDD	
11		1427.9-1452.9 MHz	1475.9-1500.9 MHz	FDD	
12	Low-Band	698-716 MHz	728-746 MHz	FDD	
13	Low-Band	777-787 MHz	746-756 MHz	FDD	
14	Low-Band	788-798 MHz	758-768 MHz	FDD	
17	Low-Band	704-716 MHz	734-746 MHz	FDD	
18	Low-Band	815-830 MHz	860-875 MHz	FDD	
19	Low-Band	830-845 MHz	875-890 MHz	FDD	
20	Low-Band	832-862 MHz	791-821 MHz	FDD	
21		1447.9-1462.9 MHz	1495.9-1510.9 MHz	FDD	
22		3410-3500 MHz	3510-3600 MHz	FDD	
23	Mid-Band	2000-2020 MHz	2180-2200 MHz	FDD	
24		1626.5-1660.5 MHz	1525-1559 MHz	FDD	
25	Mid-Band	1850-1915 MHz	1930-1995 MHz	FDD	
26	Low-Band	814-849 MHz	859-894 MHz	FDD	
27	Low-Band	807-824 MHz	852-869 MHz	FDD	
28	Low-Band	703-748 MHz	758-803 MHz	FDD	
29	Low-Band	N/A	716-728 MHz	FDD	
33	Mid-Band	1900-1920 MHz		TDD	
34	Mid-Band	2010-2025 MHz		TDD	
35	Mid-Band	1850-1910 MHz		TDD	
36	Mid-Band	1930-1990 MHz		TDD	
37	Mid-Band	1910-1930 MHz		TDD	
38	High-Band	2570-2620 MHz		TDD	
39	Mid-Band	1880-1920 MHz		TDD	
40	High-Band	2300-2400 MHz		TDD	
41	High-Band	2496-2690 MHz		TDD	
42		3400-3600 MHz		TDD	
43		3600-3800 MHz		TDD	
44	Low-Band	703-803 MHz		TDD	

In order to cover all the bands from different countries in a unique device, mobile phones and data cards are usually equipped more bands and band combinations. Some typical examples are quad-band combinations of band 1/2/5/8, 1/3/5/7 and 3/7/5/17. The frequency bands used by TD-LTE are 3.4–3.6 GHz in Australia and UK, 2.57–2.62 GHz in the US and China, 2.545-2.575 GHz in Japan, and 2.3–2.4 GHz in India and Australia.

LTE LNA for Single Band-7 Application

Introduction

1.2 Applications

Figure 1 shows an example of the block diagram of the front-end of a 4G modem. A SPnT switch connects one side the antenna and several duplexers for different 4G bands on the other side. Every duplexer is connected to the transmitting (TX) and receiving (RX) paths of each band. The external LNA, here for example Infineon single-band LNA BGA7H1N6, is placed on the RX path between the duplex and the bandpass SAW filter. The output of the SAW filter is connected to the receiver input of the transceiver IC.

Depending on the number of bands designed in a device, various numbers of LNAs are required in a system. Recently, even mobile devices with 5 modes 13 bands are under discussion. Not only for the main pathes, but also for the diversity pathes, the external LNAs are widely used to boost end user experience while using mobile devices for video and audio streaming.

Besides low noise amplifiers, Infineon Technologies also offers solutions for high power highly linear antenna switches, band switches as well as power detection diodes for power amplifiers.

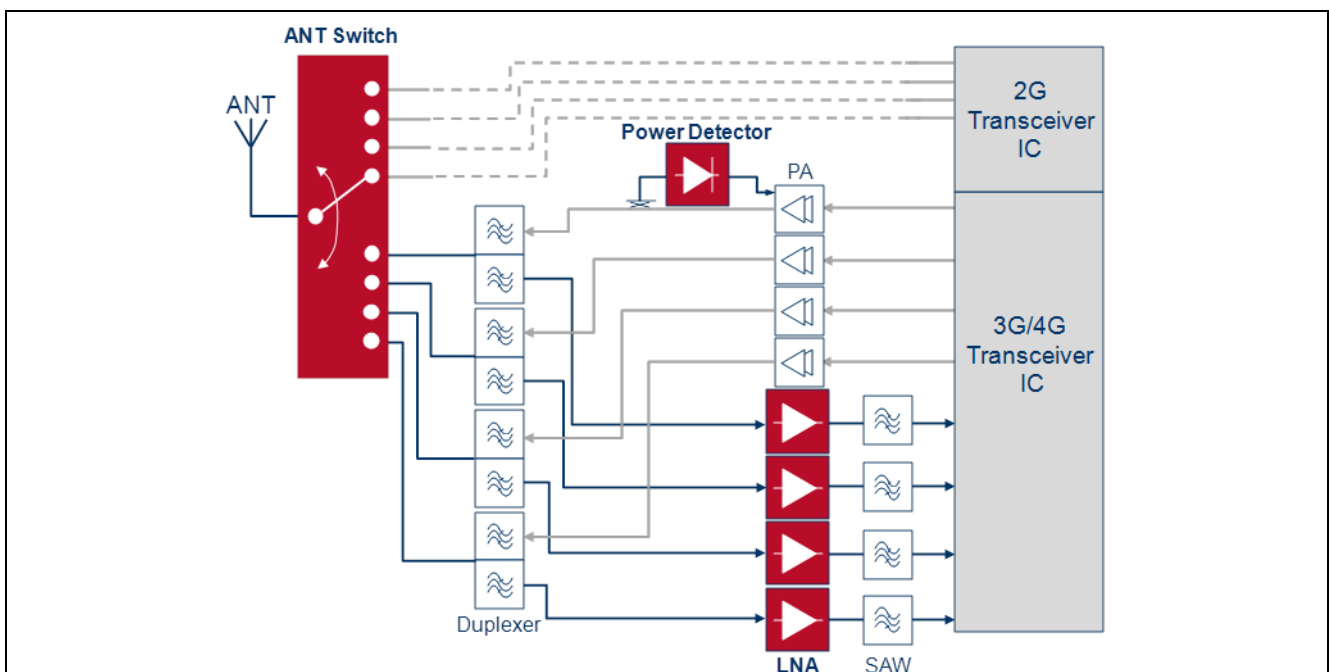

Figure 1 Example of Application Diagram of RF Front-End for 3G and 4G Systems.

LTE LNA for Single Band-7 Application

Introduction

1.3 Infineon LNAs for 3G, 4G LTE and LTE-A Applications

With the increasing wireless data speed and with the extended link distance of mobile phones and 4G data cards, the requirements on the sensitivity are much higher. Infineon offers different kind of low noise amplifiers (LNAs) to support the customers for mobile phones and data cards of 4G LTE and LTE-A to improve their system performance to meet the requirements coming from the networks/service providers.

The benefits to use external LNAs in equipment for 4G LTE and LTE-A applications are:

- Flexible design to place the front-end components: due to the size constraint, the modem antenna and the front-end can not be always put close to the transceiver IC. The path loss in front of the integrated LNA on the transceiver IC increases the system noise figure noticeably. An external LNA physically close to the antenna can help to eliminate the path loss and reduce the system noise figure. Therefore the sensitivity can be improved by several dB.
- Support RX carrier aggregation where two LNAs can be tuned on at the same time.
- Boost the sensitivity by reducing the system noise figure: external LNA has lower noise figure than the integrated LNA on the transceiver IC.
- Bug fix to help the transceiver ICs to fulfill the system requirements.
- Increase the dynamic range of the power handling.

Infineon Technologies is the leading company with broad product portfolio to offer high performance SiGe:C bipolar transistor LNAs and MMIC LNAs for various wireless applications by using the industrial standard silicon process. The MMIC LNA portfolio includes:

- New generation single band LTE LNAs like BGA7H1N6 for high-band (HB, 2300-2700 MHz), BGA7M1N6 for mid-band (MB, 1805-2200 MHz) and BGA7L1N6 for low-band (LB, 728-960 MHz) are available.
- New generation LTE LNA Banks are quad-band. Currently there are six different types of these new LTE LNAs which are shown in **Table 2**. Each LNA bank combines four various bands LNA from the high-band (HB, 2300-2700 MHz), mid-band (MB, 1805-2200 MHz) and low-band (LB, 728-960

LTE LNA for Single Band-7 Application

Introduction

MHz). Two of the four LNAs in one LNA bank can be turned on at the same time to support carrier aggregation.

The broad product portfolio with highest integration and best features in noise figure and flexible band selection helps designers to design mobile phones and data cards with outstanding performance. Therefore Infineon LNAs and LNA banks are widely used by mobile phone vendors.

Table 2 Infineon Product Portfolio of LNAs for 4G LTE and LTE-A Applications

Frequency Range	728 MHz–960 MHz	1805MHz–2200MHz	2300 MHz–2690 MHz	Comment
Single-Band LNA				
BGA7L1N6	1X			
BGA7M1N6		1X		
BGA7L1N6			1X	
Quad-Band LNA bank				
BGM7MLLH4L12	1X	2X	1X	
BGM7LMHM4L12	1X	2X	1X	
BGM7HHMH4L12		1X	3X	
BGM7MLLM4L12	2X	2X		
BGM7LLHM4L12	2X	1X	1X	
BGM7LLMM4L12	2X	2X		

In addition, the older generation of LTE LNAs are featured with gain switching functions which is often helpful for the cases that string or weak signal environment could happen in the field. Error! eference source not found. shows the available band combinations:

- Single-band LNAs like BGA777L7 / BGA777N7 for high-band (2300-2700 MHz), BGA711L7 / BGA711N7 for mid-band (MB, 1700-2300 MHz) and BGA751L7 / BGA751N7, BGA728L7/BGA728N7, BGA713L7/BGA713N7 for low-band (LB, 700-1000 MHz) are available.

- Dual-band LNA BGA771L16 supports 1x mid-band (MB, 1700-2300 MHz) and 1x low-band (LB, 700-1000 MHz).

- Triple-band LNAs BGA734N16, BGA735N16 and BGA736N16 are available to cover the most bands. All of the three triple-band LNAs can support designs covering 2x high-bands and 1x low-band.

LTE LNA for Single Band-7 Application

Introduction

- Both BGA748N16 and BGA749N16 are quad-band LNAs. BGA748N16 can cover 2x high-and 2x low-bands and BGA749N16 can cover 1x high-band and 3x low-bands.

Table 3 Infineon Product Portfolio of LNAs for 3G and 4G Applications

Frequency Range	700 MHz – 1 GHz	1700MHz – 2200MHz	2100 MHz – 2700 MHz	Comment
Single-Band LNA				
BGA711N7			1X	
BGA713N7	1X			
BGA751N7	1X			
BGA777N7			1X	
BGA728L7	1X	1X		
Dual Band LNA				
BGA771N16	1X	1X		
Triple Band LNA				
BGA735N16	1X	1X	1X	
BGA736L16	1X	1X	1X	
Quad-band LNA				
BGA748L16	2X		2X	
BGA749N16	3X		1X	

2 BGA7H1N6 Overview

2.1 Features

- Insertion power gain: 12.5 dB
- Low noise figure: 0.60 dB
- Low current consumption: 4.7 mA
- Operating frequencies: 2300 - 2690 MHz
- Supply voltage: 1.5 V to 3.3 V
- Digital on/off switch (1V logic high level)
- Ultra small TSNP-6-2 leadless package (footprint: 0.7 x 1.1 mm²)
- B7HF Silicon Germanium technology
- RF output internally matched to 50 Ω
- Only 1 external SMD component necessary
- 2kV HBM ESD protection (including AI-pin)
- Pb-free (RoHS compliant) package

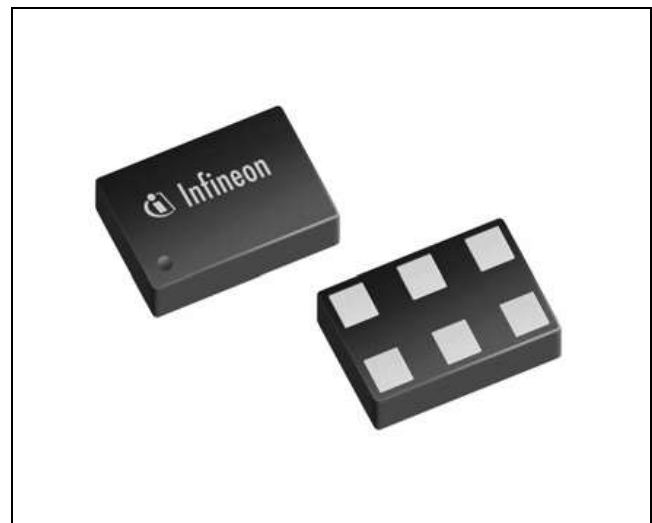

Figure 2 BGA7H1N6 in TSNP-6-2



2.2 Key Applications of BGA7H1N6

As Low Noise Amplifier (LNA) to support 4G LTE and LTE-A 3G/4G/LTE/LTE-Advanced applications for mobile phones and data cards.

2.3 Description

The BGA7H1N6 is a front-end low noise amplifier for LTE which covers a wide frequency range from 2300 MHz to 2690 MHz. The LNA provides 12.5 dB gain and 0.60 dB noise figure at a current consumption of 4.7 mA in the application configuration described in **Chapter 3**. The BGA7H1N6 is based upon Infineon Technologies' B7HF Silicon Germanium technology. It operates from 1.5 V to 3.3 V supply voltage.

LTE LNA for Single Band-7 Application

BGA7H1N6 Overview

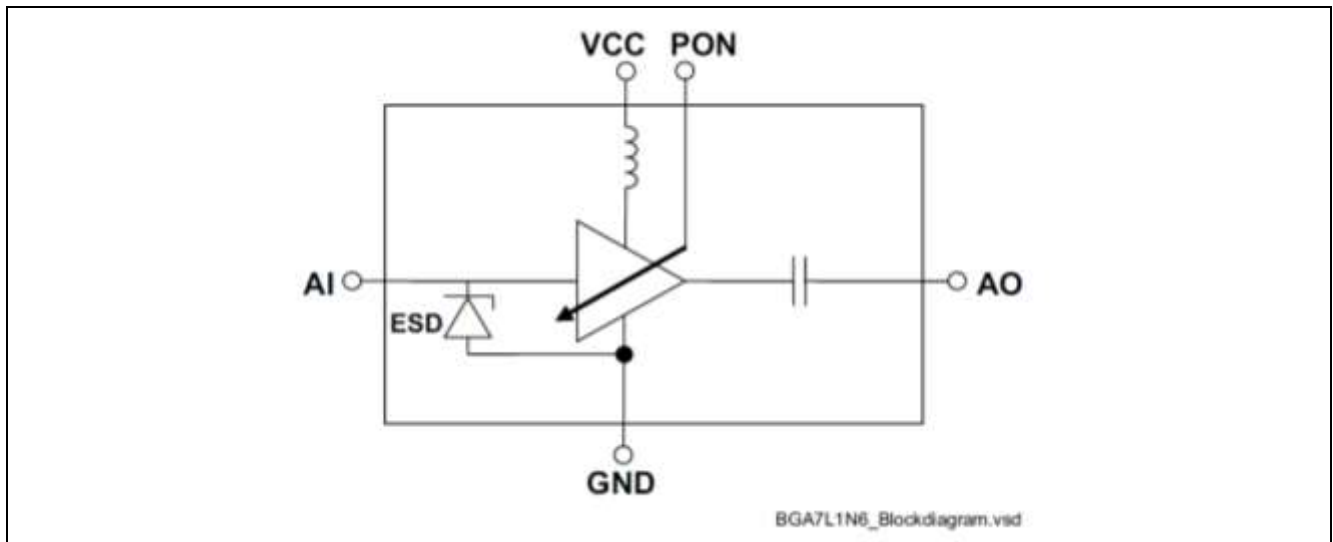

Figure 1 Equivalent Circuit of BGA7H1N6

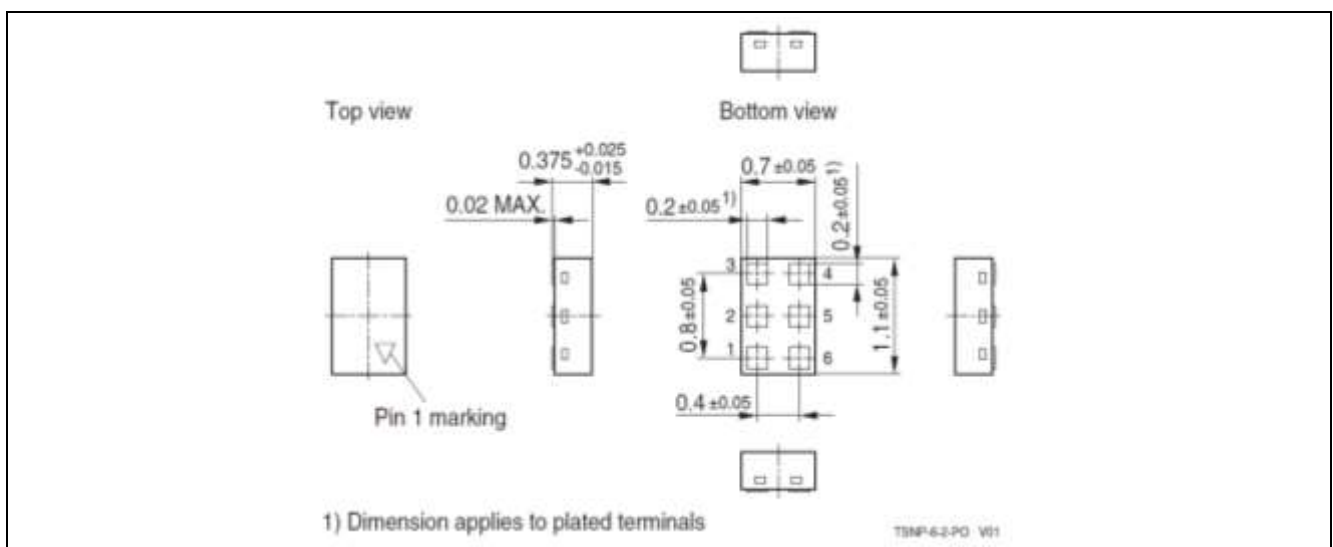

Figure 2 Package and pin connections of BGA7H1N6

Table 4 Pin Assignment of BGA7H1N6

Pin No.	Symbol	Function
1	GND	Ground
2	VCC	Supply Voltage
3	AO	LNA output
4	GND	Ground
5	AI	LNA input
6	PON	Power on control

LTE LNA for Single Band-7 Application

Application Circuit and Performance Overview

3 Application Circuit and Performance Overview

Device: BGA7H1N6
Application: Low Noise Amplifier for LTE Band 7 Application (2620 – 2690 MHz)
PCB Marking: BGA7x1N6 V1.0
EVB Order No.: AN406

3.1 Summary of Measurement Results

Table 5 Electrical Characteristics (at room temperature) for Band-7 (2620 – 2690 MHz), $V_{CC} = 1.8\text{ V}$, $V_{PON} = 1.8\text{ V}$

Parameter	Symbol	Value			Unit	Comment/Test Condition
Frequency Range	Freq	2620	2655	2690	MHz	
DC Voltage	Vcc	1.8			V	
DC Current	Icc	4.8			mA	
Gain	G	12.5	12.4	12.3	dB	
Noise Figure	NF	0.79	0.78	0.78	dB	PCB and SMA loses 0.1 dB are subtracted
Input Return Loss	RLin	11.6	12.1	12.6	dB	
Output Return Loss	RLout	20.4	23.2	25.9	dB	
Reverse Isolation	IRev	19.4	19.3	19.2	dB	
Input P1dB	IP1dB	-4.9			dBm	Measured at f = 2655 MHz
Output P1dB	OP1dB	6.5			dBm	Measured at f = 2655 MHz
Input IP3	IIP3	5.7			dBm	Power @ Input: -35 dBm $f_1=2655\text{ MHz}$, $f_2=2656\text{ MHz}$
Output IP3	OIP3	18.1			dBm	
Stability	k	>1			--	Measured up to 10 GHz

LTE LNA for Single Band-7 Application

Application Circuit and Performance Overview

Table 6 Electrical Characteristics (at room temperature)) for Band-7 (2620 – 2690 MHz), $V_{CC} = 2.8$ V, $V_{PON} = 2.8$ V

Parameter	Symbol	Value			Unit	Comment/Test Condition
Frequency Range	Freq	2620	2655	2690	MHz	
DC Voltage	Vcc	2.8			V	
DC Current	Icc	4.9			mA	
Gain	G	12.6	12.5	12.5	dB	
Noise Figure	NF	0.79	0.79	0.78	dB	PCB and SMA loses 0.1 dB are subtracted
Input Return Loss	RLin	11.9	12.4	12.9	dB	
Output Return Loss	RLout	19.5	22.7	27.2	dB	
Reverse Isolation	IRev	19.7	19.6	19.5	dB	
Input P1dB	IP1dB	-1.6			dBm	Measured at f = 2655 MHz
Output P1dB	OP1dB	9.9			dBm	Measured at f = 2655 MHz
Input IP3	IIP3	6.3			dBm	Power @ Input: -35 dBm $f_1=2655$ MHz, $f_2=2656$ MHz
Output IP3	OIP3	18.8			dBm	
Stability	k	>1			--	Measured up to 10 GHz

3.2 BGA7H1N6 as Low Noise Amplifier for LTE Single Band-7 (2620 – 2690 MHz) Application

This application note focuses on the Infineon's Single-Band LTE LNA, BGA7H1N6 tuned for the Band-7. It presents the performance of BGA7H1N6 with 1.8 V and 2.8 V power supply with the operating current of 4.7 mA.

At 1.8 V, the circuit offers a gain of 12.4 dB. It achieves input return loss as well as output return loss better than 11 dB. The input 1 dB compression point is -4.9 dBm at 2655 MHz. Using two tones spacing of 1 MHz, the input third order intercept point (IIP3) reaches 5.7 dBm at 2655 MHz. At room temperature the noise figure is 0.78 dB excluding SMA and PCB losses.

At 2.8 V, the circuit offers a gain of 12.5 dB. It achieves input return loss as well as output return loss better than 11 dB. The input 1 dB compression point is -1.6 dBm at 2655 MHz. Using two tones spacing of 1 MHz, the input third order intercept point (IIP3) reaches 6.3 dBm at 2655 MHz. At room temperature the noise figure is 0.79 dB excluding SMA and PCB losses.

Furthermore, the circuit is measured unconditionally stable till 10 GHz. All the measurements are done with the standard evaluation board presented at the end of this application note.

LTE LNA for Single Band-7 Application

Application Circuit and Performance Overview

3.3 Schematics and Bill-of-Materials

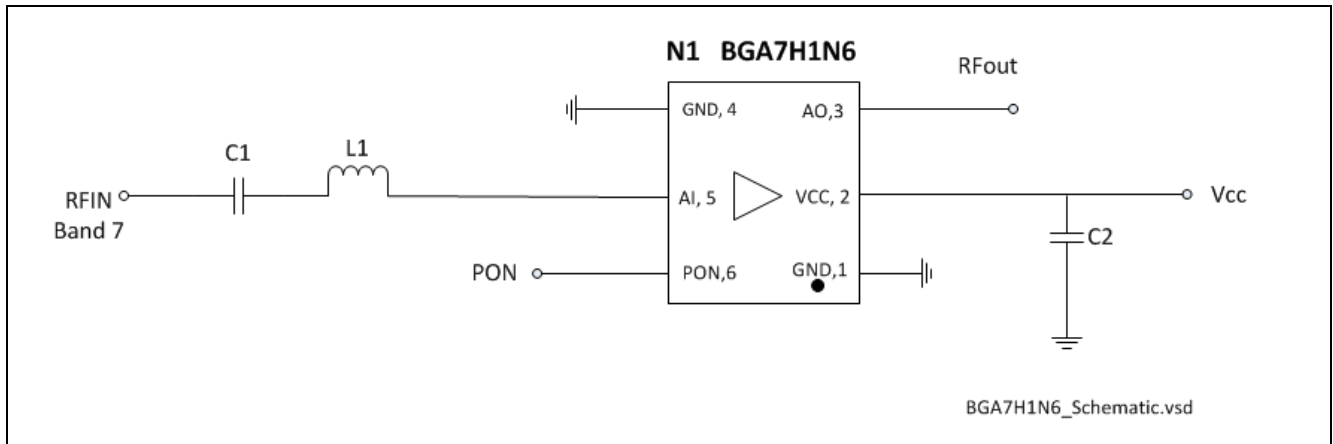

Figure 3 Schematics of the BGA7H1N6 Application Circuit

Table 7 Bill-of-Materials

Symbol	Value	Unit	Size	Manufacturer	Comment
C1	1	nF	0402	Various	DC block (optional)
C2	1	nF	0402	Various	RF to ground (optional)
L1	3.3	nH	0402	Murata LQW series	Input matching
N1	BGA7H1N6	TSNP-6-2		Infineon	SiGe LNA

4 Measurement Graphs

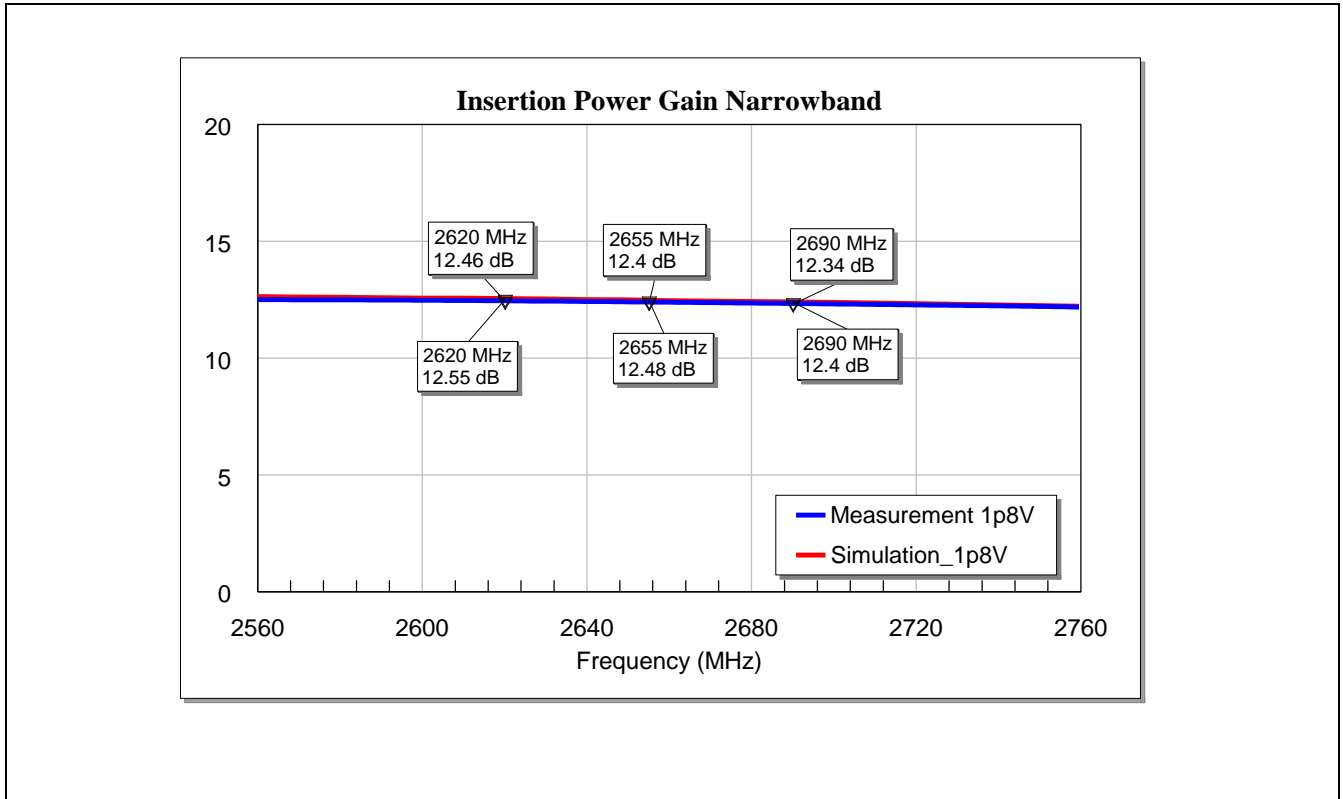

Figure 4 Insertion Power Gain (Narrowband) of the BGA7H1N6 for LTE Band-7 at Vcc = 1.8 V

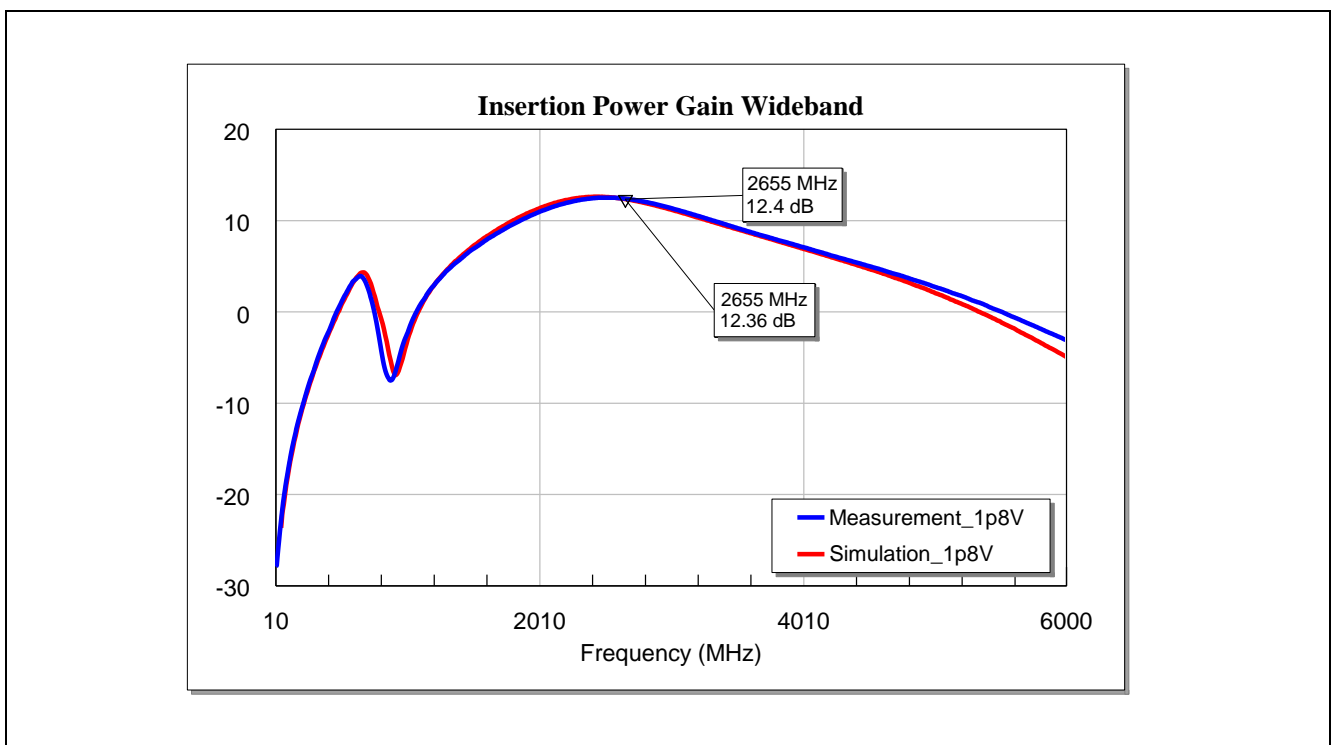

Figure 5 Insertion Power Gain (Wideband) of the BGA7H1N6 for LTE Band-7 at Vcc = 1.8 V

LTE LNA for Single Band-7 Application

Measurement Graphs

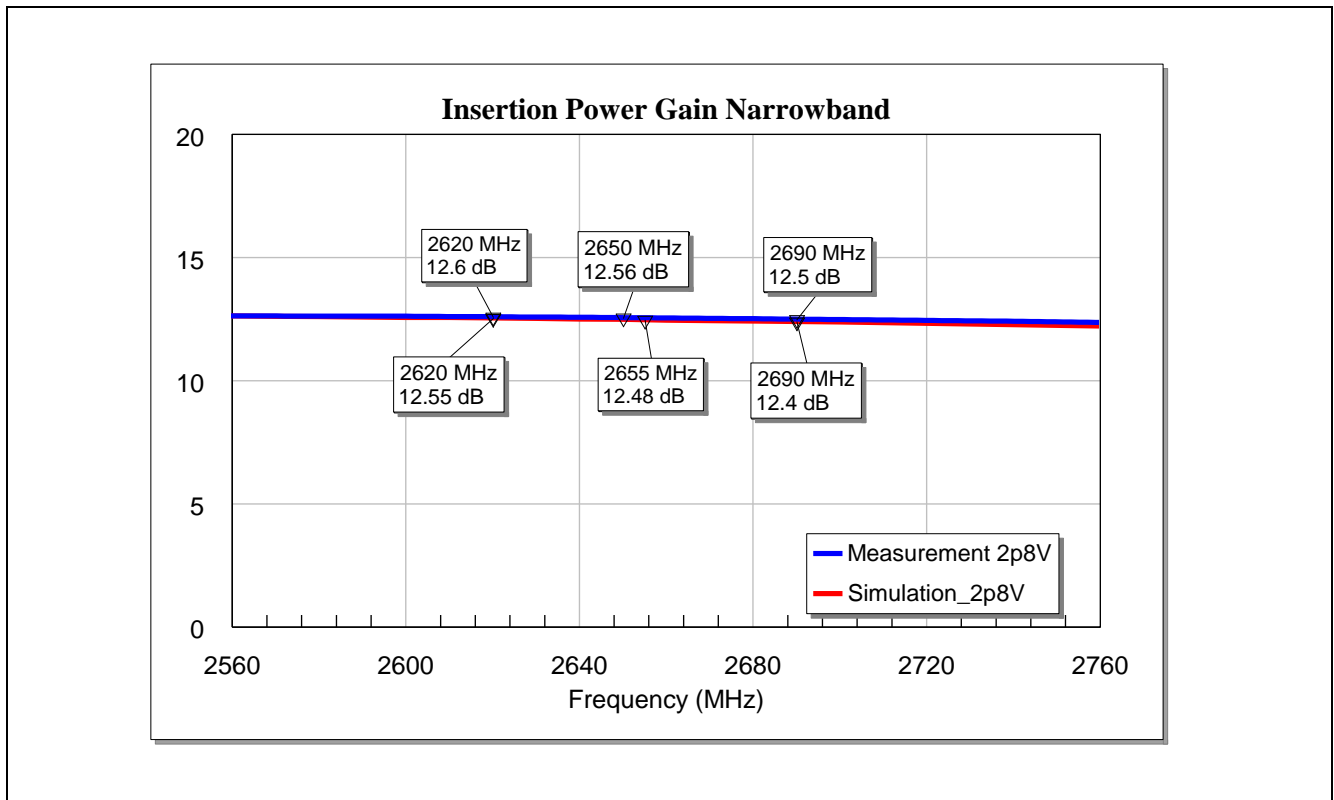

Figure 6 Insertion Power Gain (Narrowband) of the BGA7H1N6 for LTE Band-7 at Vcc = 2.8 V

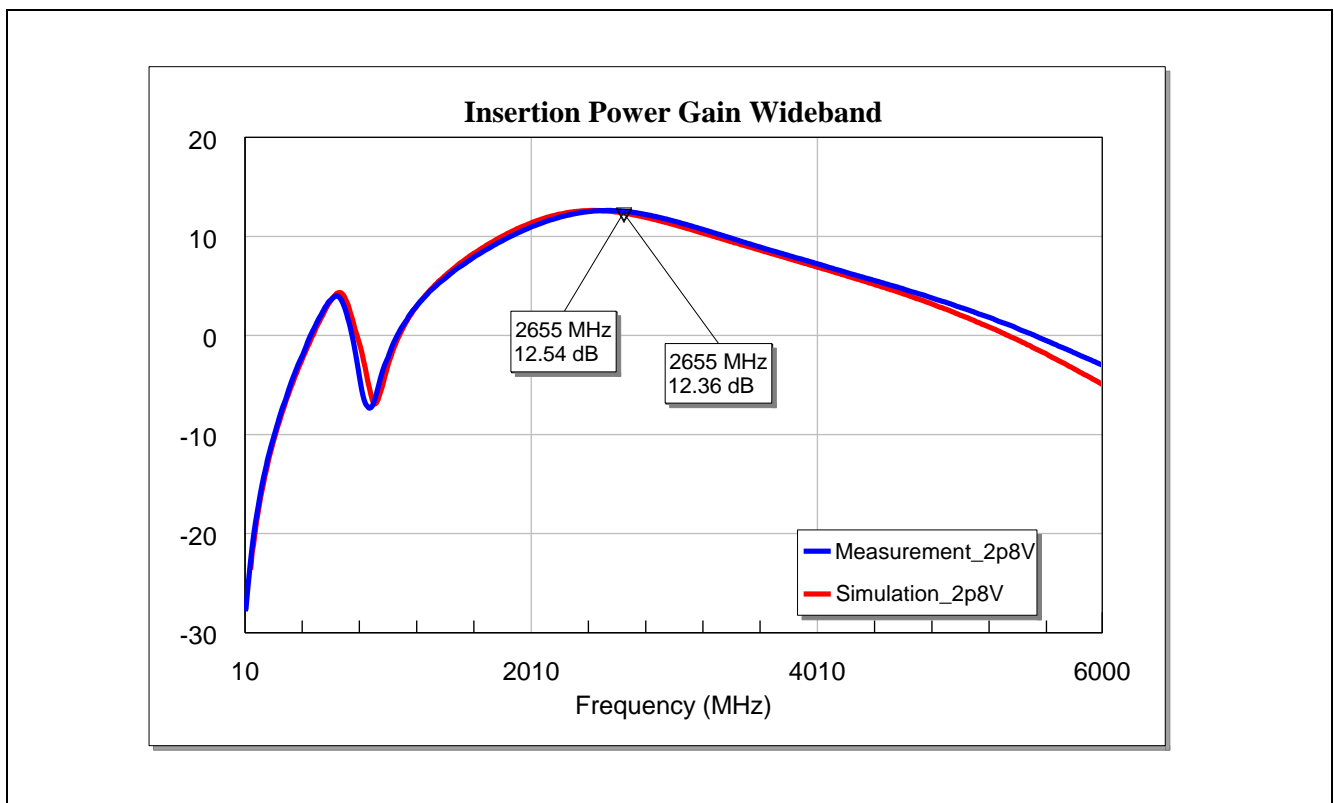

Figure 7 Insertion Power Gain (Wideband) of the BGA7H1N6 for LTE Band-7 at Vcc = 2.8 V

LTE LNA for Single Band-7 Application

Measurement Graphs

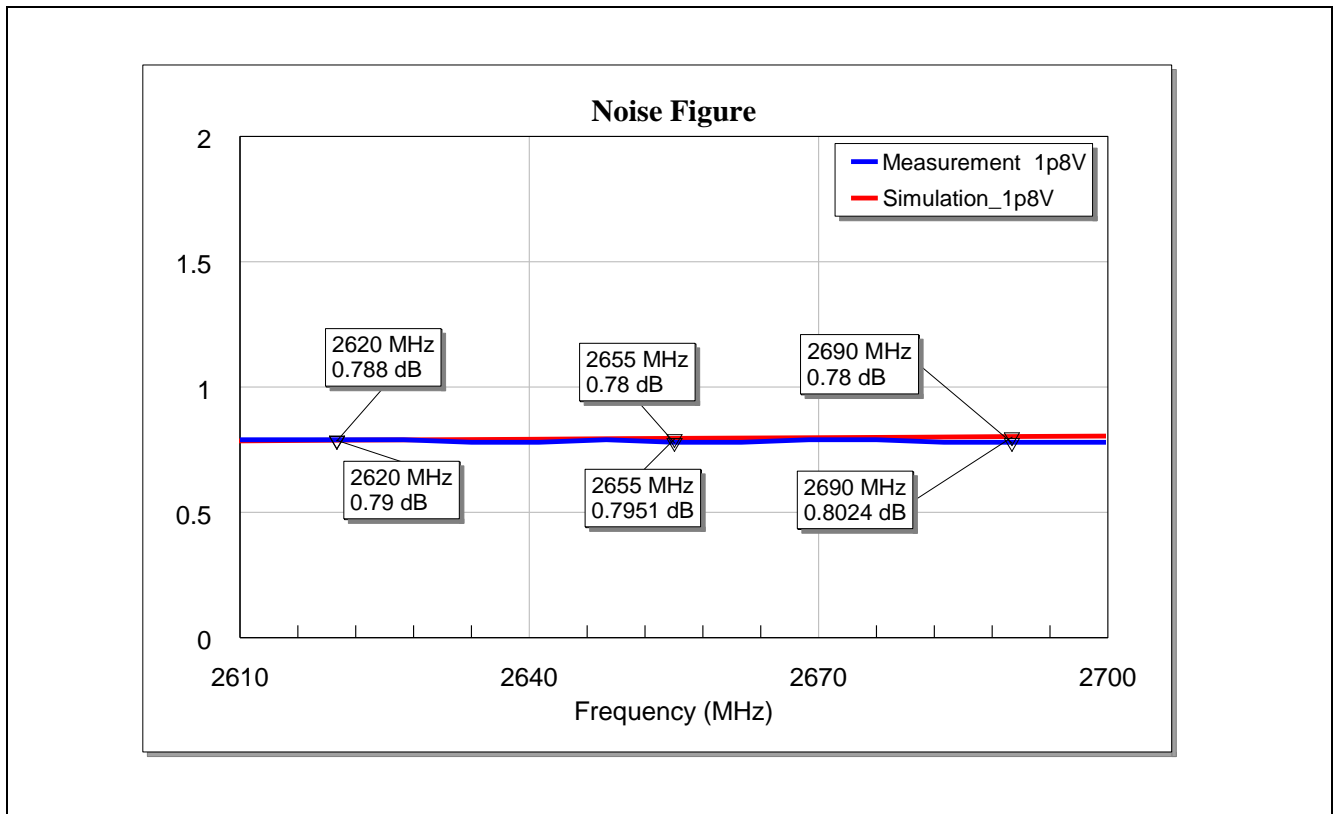

Figure 8 Noise Figure of the BGA7H1N6 for LTE Band-7 Application at Vcc = 1.8 V

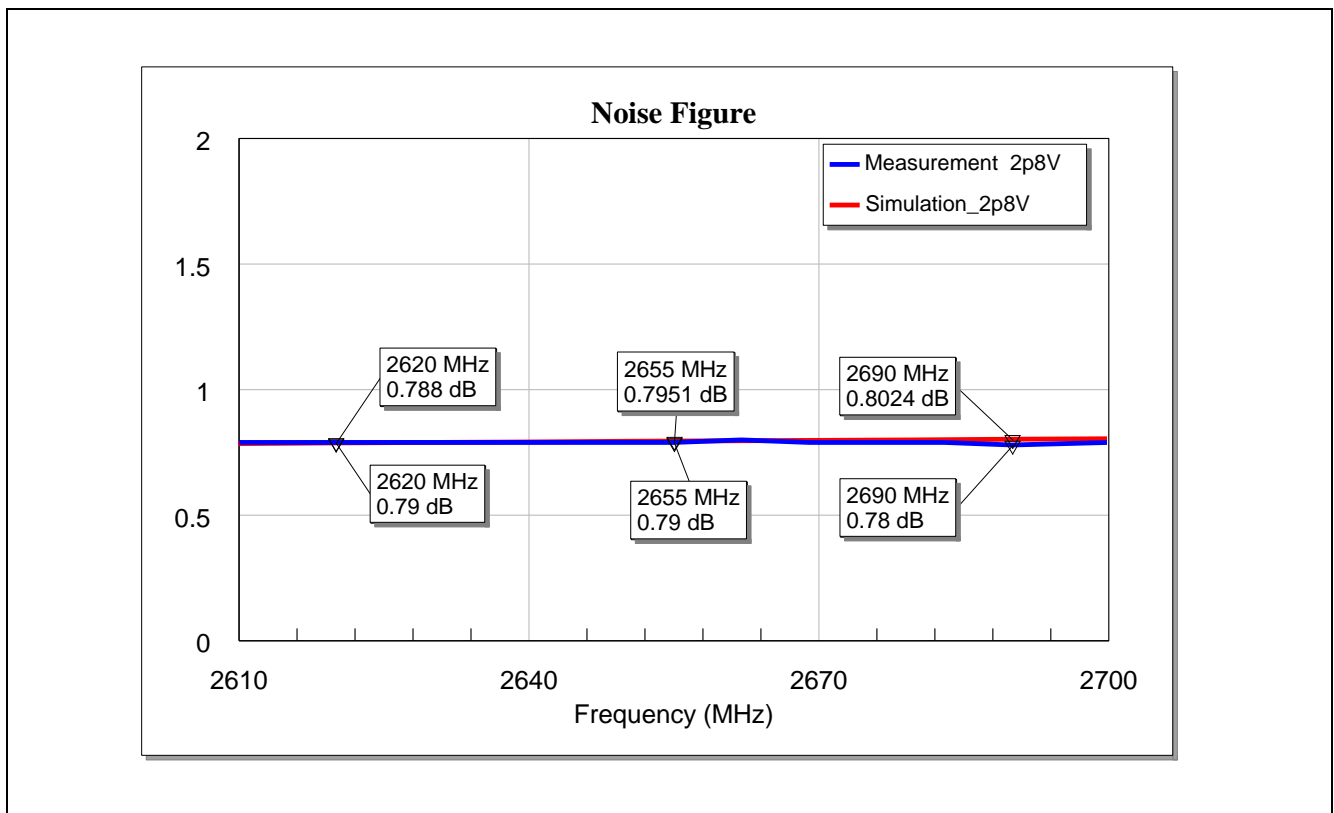

Figure 9 Noise Figure of the BGA7H1N6 for LTE Band-7 Application at Vcc = 2.8 V

LTE LNA for Single Band-7 Application

Measurement Graphs

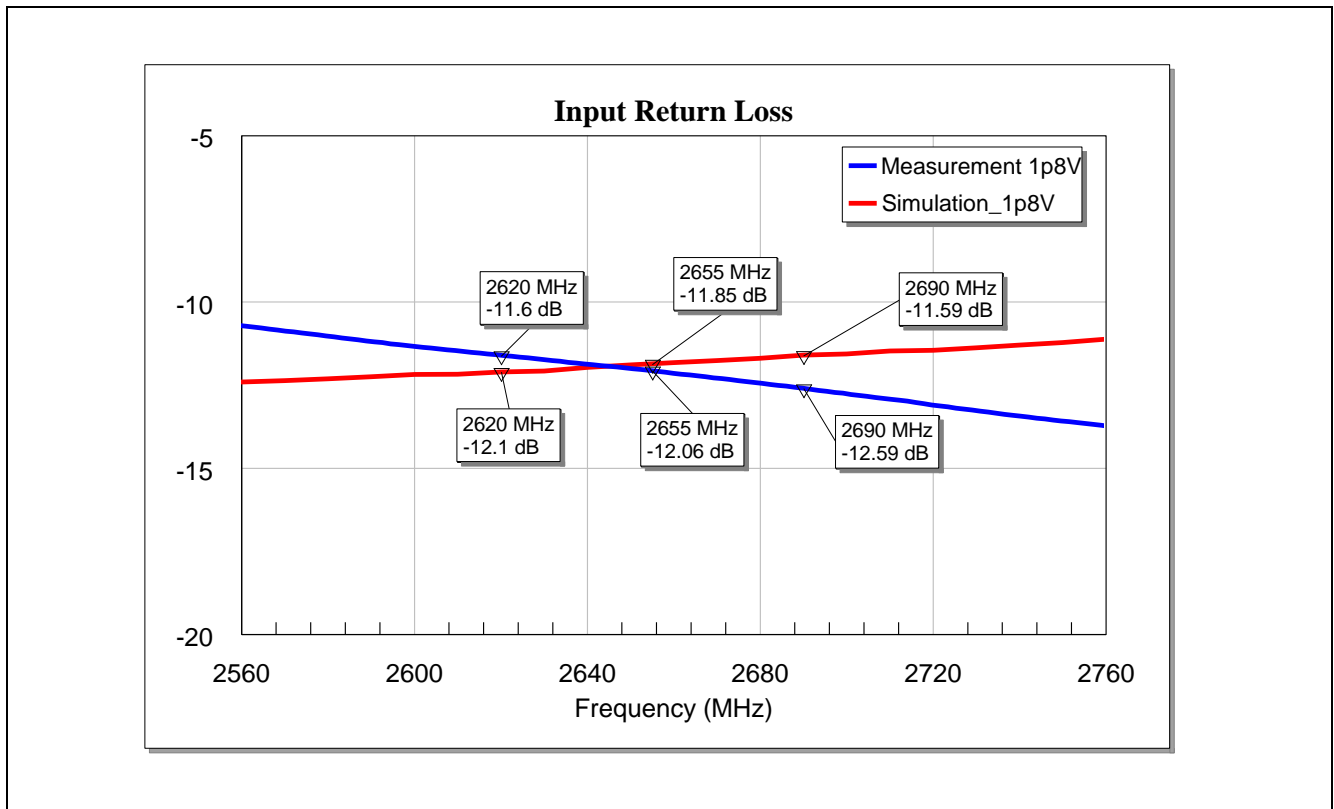

Figure 10 Input Matching of the BGA7H1N6 for LTE Band-7 Application at Vcc = 1.8 V

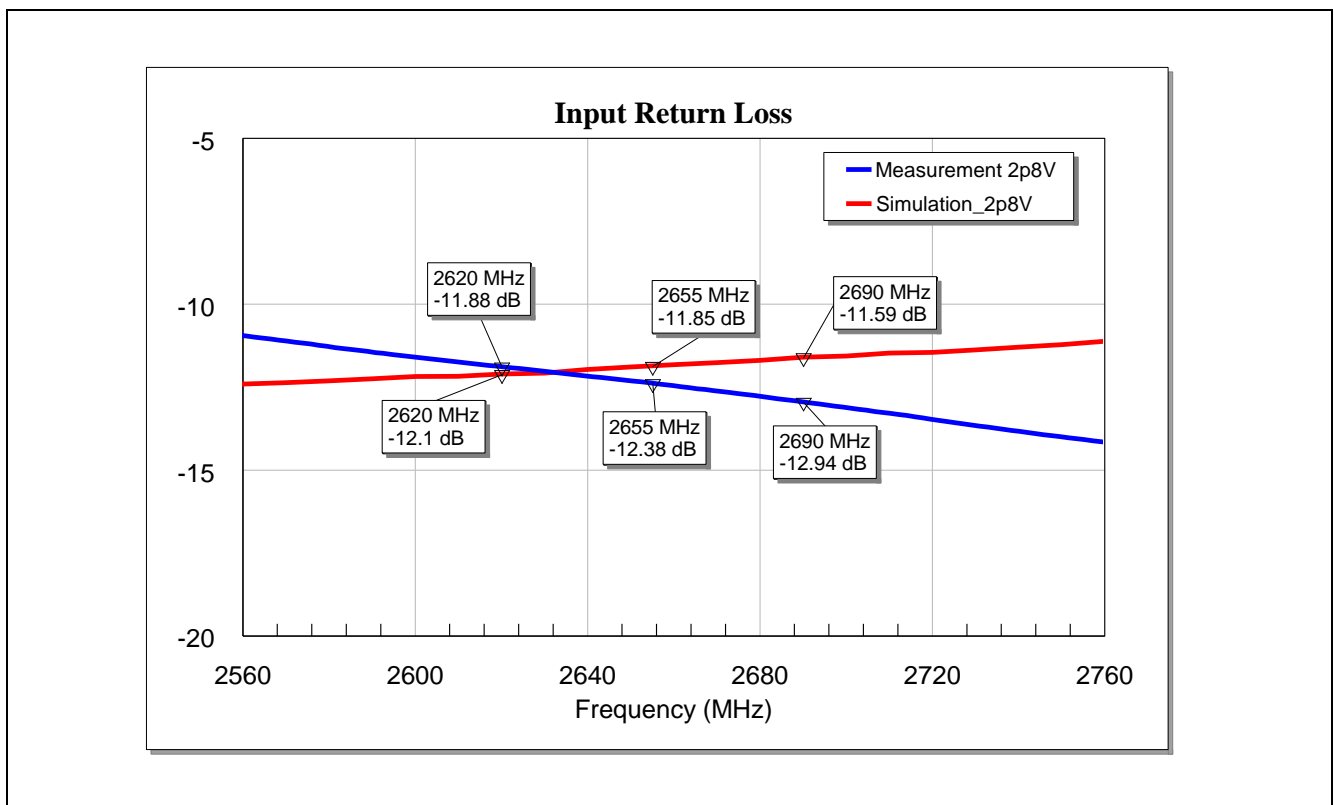

Figure 11 Input Matching of the BGA7H1N6 for LTE Band-7 Application at Vcc = 2.8 V

LTE LNA for Single Band-7 Application

Measurement Graphs

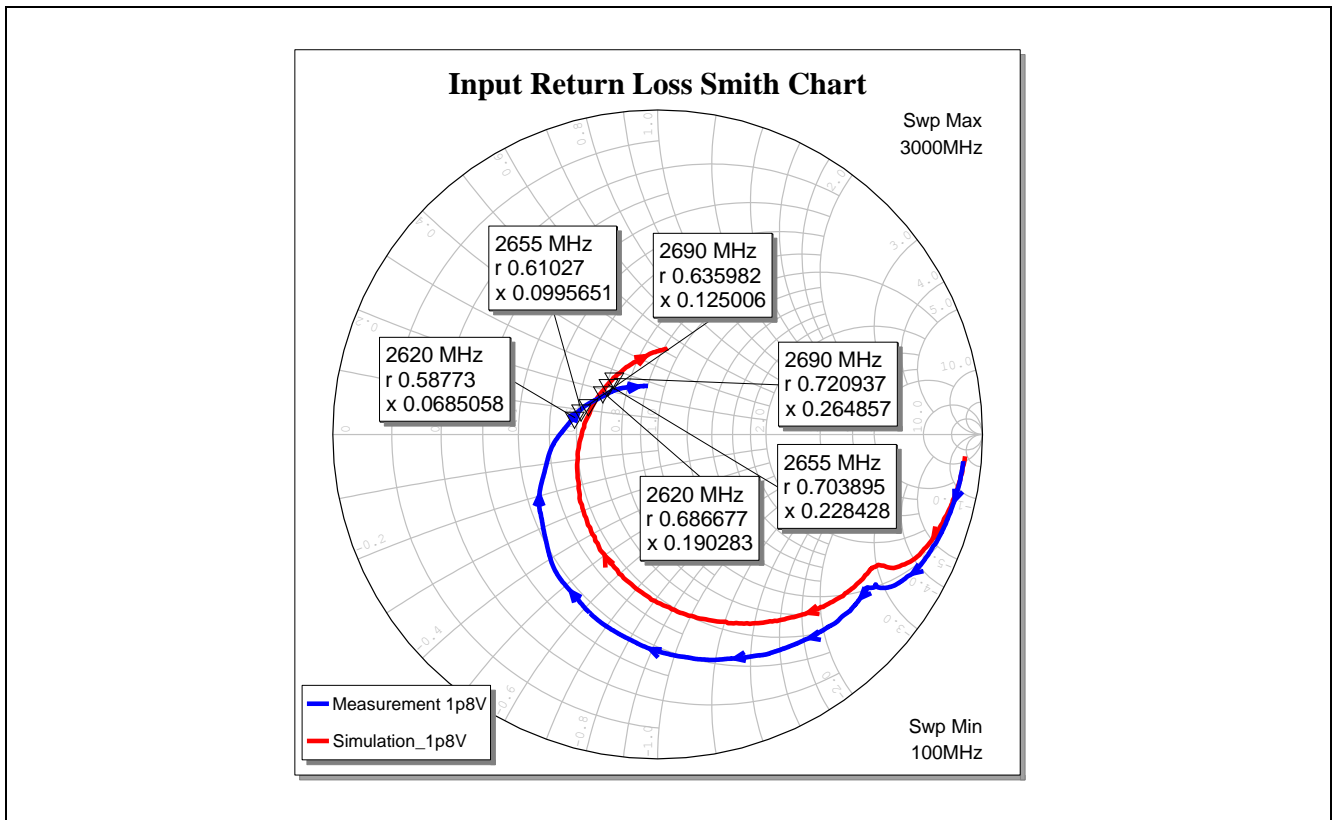

Figure 12 Input Matching (Smith Chart) of the BGA7H1N6 for LTE Band-7 Application at Vcc = 1.8 V

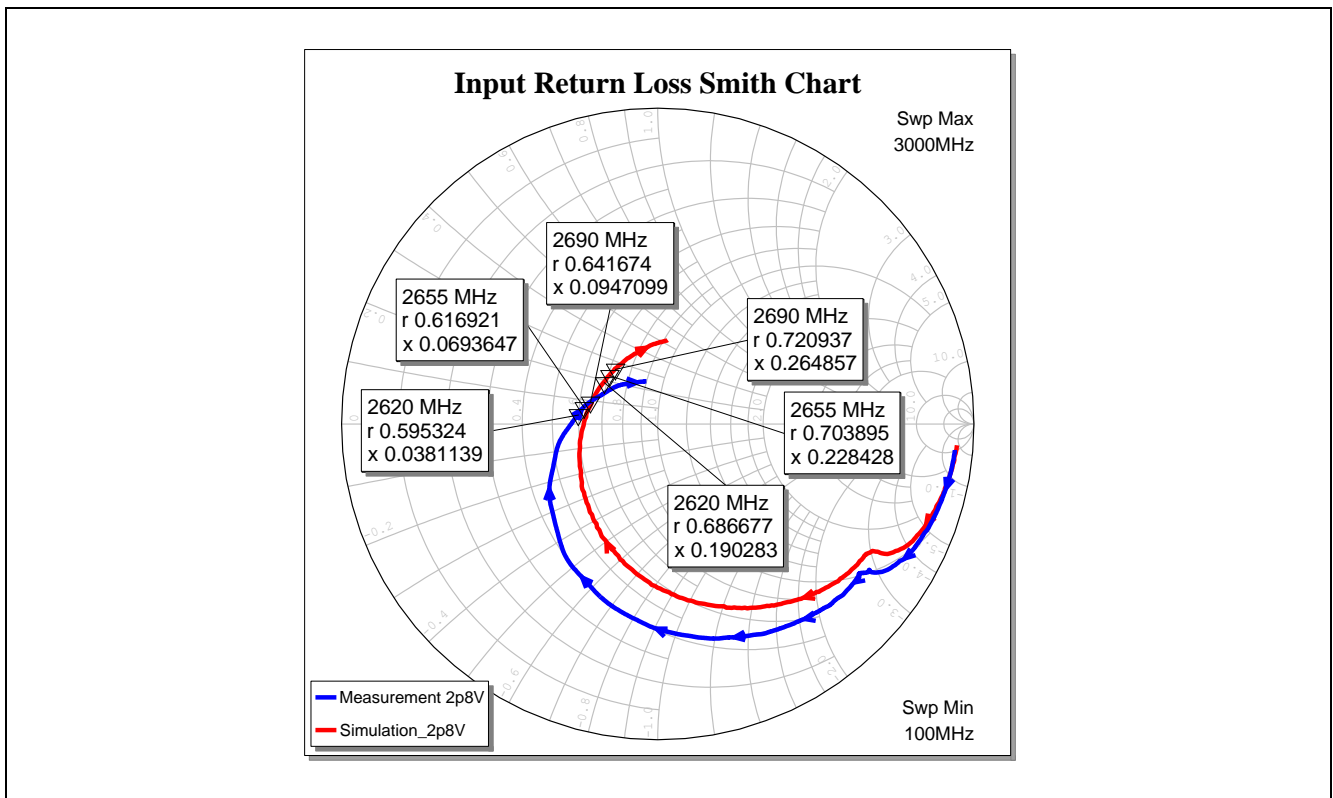

Figure 13 Input Matching (Smith Chart) of the BGA7H1N6 for LTE Band-7 Application at Vcc = 2.8 V

LTE LNA for Single Band-7 Application

Measurement Graphs

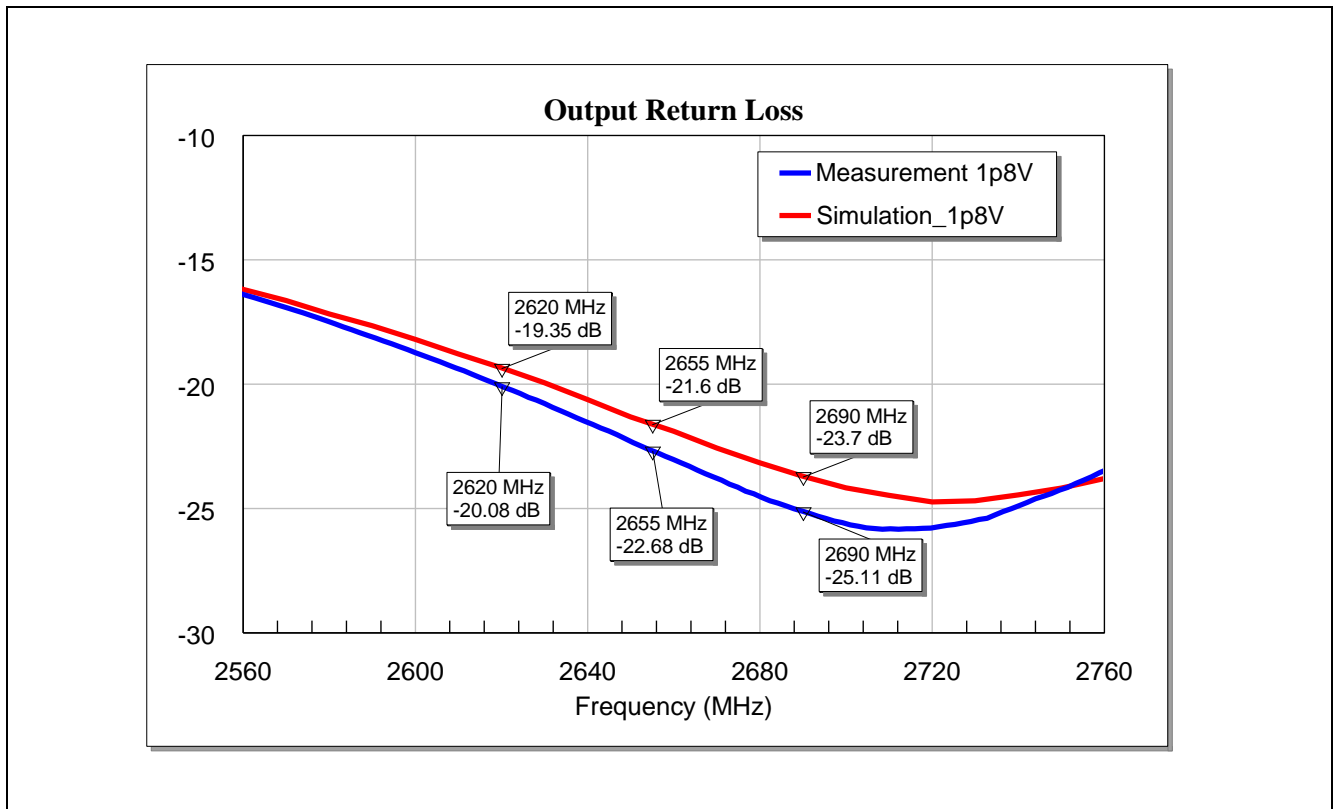

Figure 14 Output Matching of the BGA7H1N6 for LTE Band-7 Application at Vcc = 1.8 V

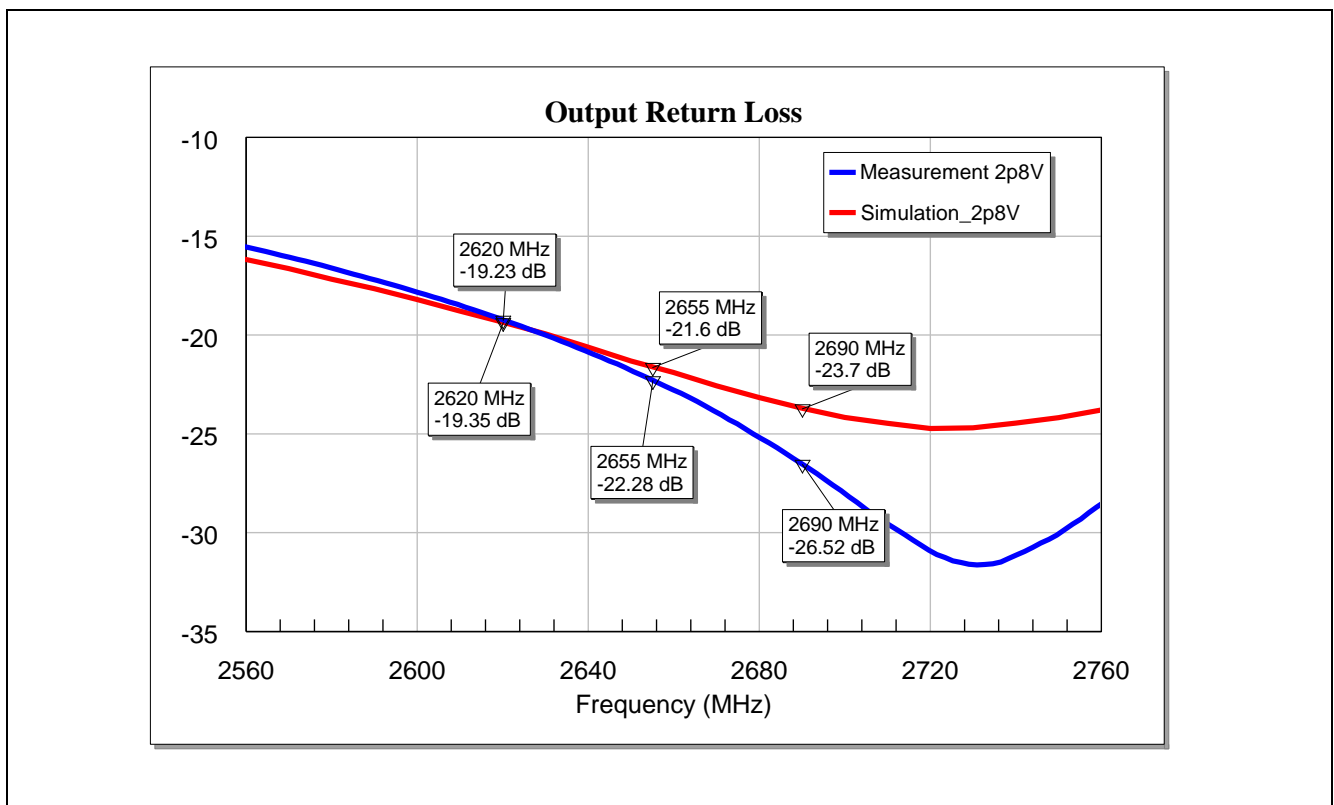

Figure 15 Output Matching of the BGA7H1N6 for LTE Band-7 Application at Vcc = 2.8 V

LTE LNA for Single Band-7 Application

Measurement Graphs

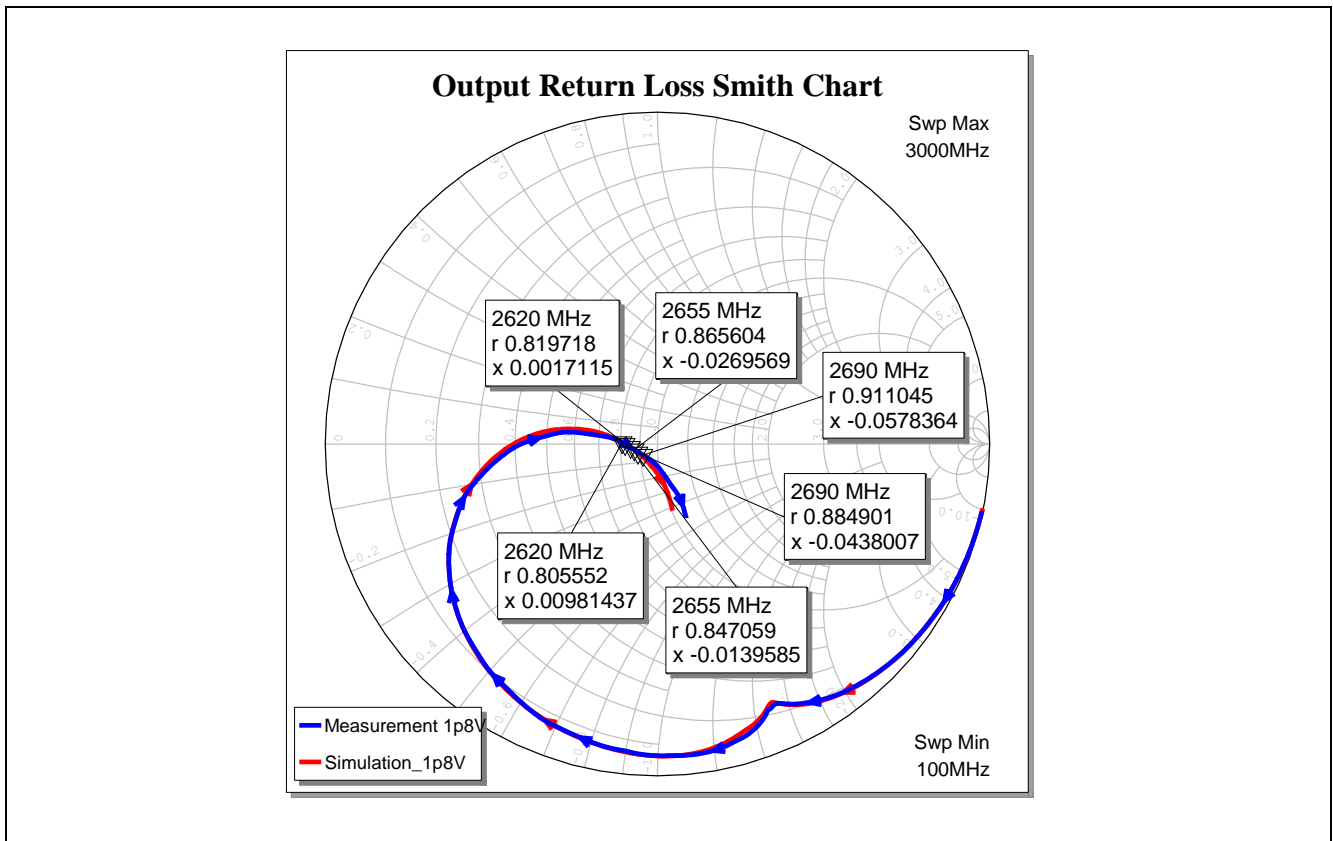

Figure 16 Output Matching (Smith Chart) of the BGA7H1N6 for LTE Band-7 Application at Vcc = 1.8 V

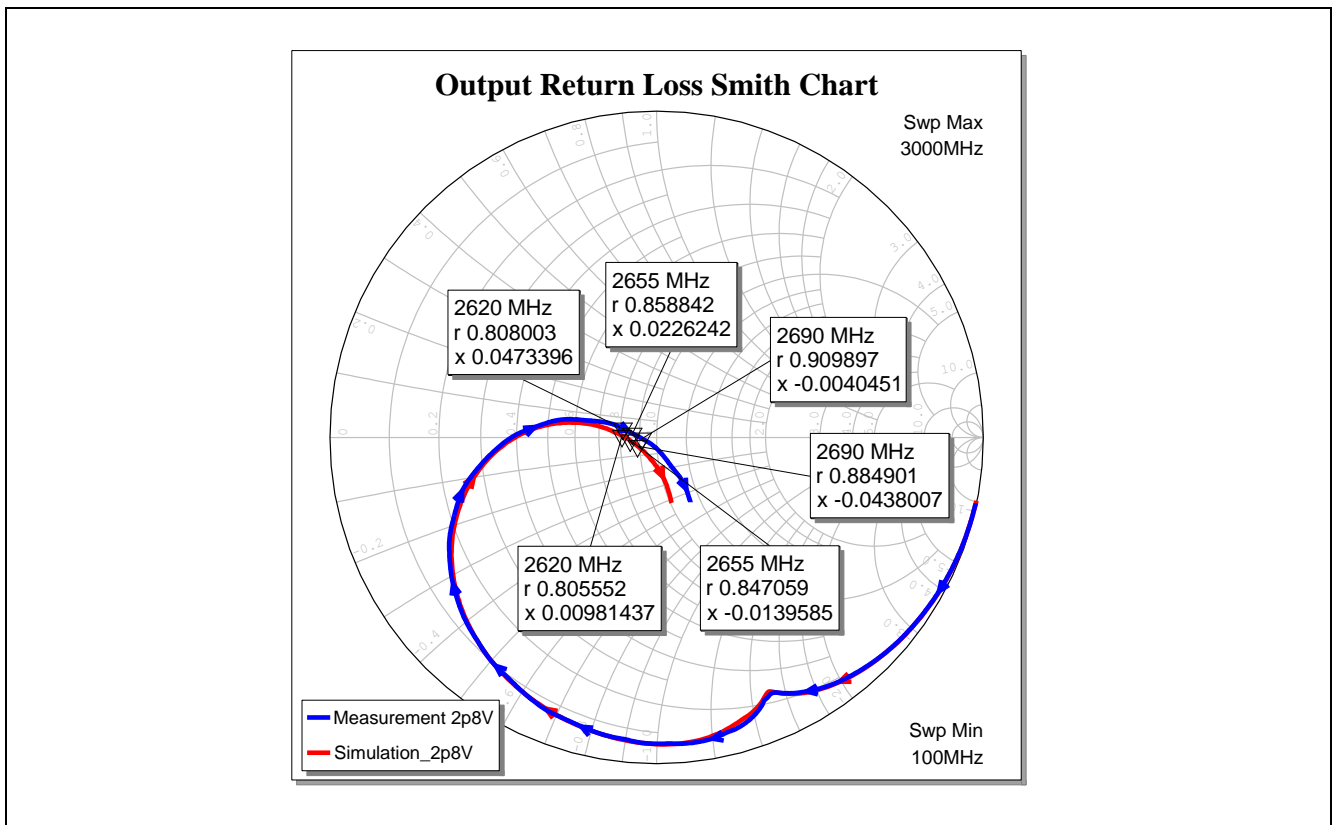

Figure 17 Output Matching (Smith Chart) of the BGA7H1N6 for LTE Band-7 Application at Vcc = 2.8 V

LTE LNA for Single Band-7 Application

Measurement Graphs

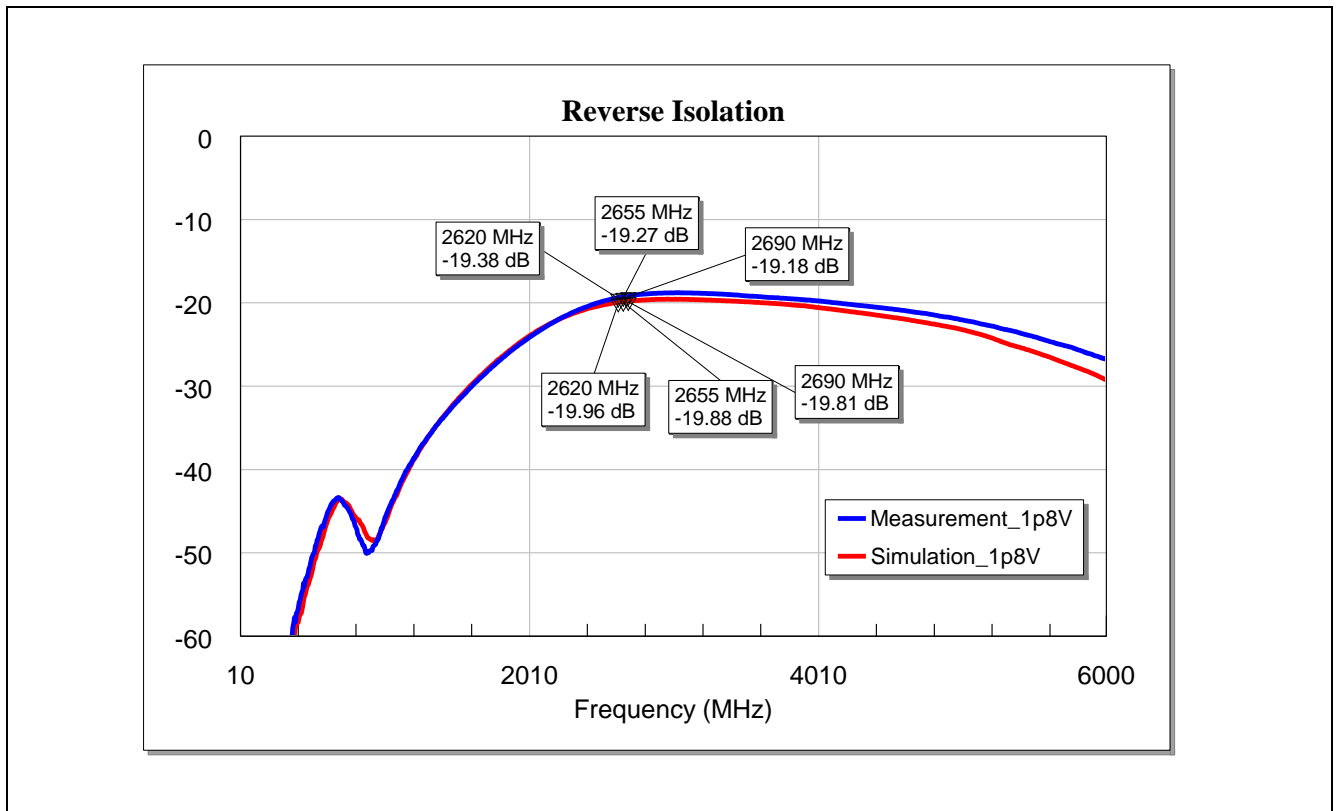

Figure 18 Reverse Isolation of the BGA7H1N6 for LTE Band-7 Application at Vcc = 1.8 V

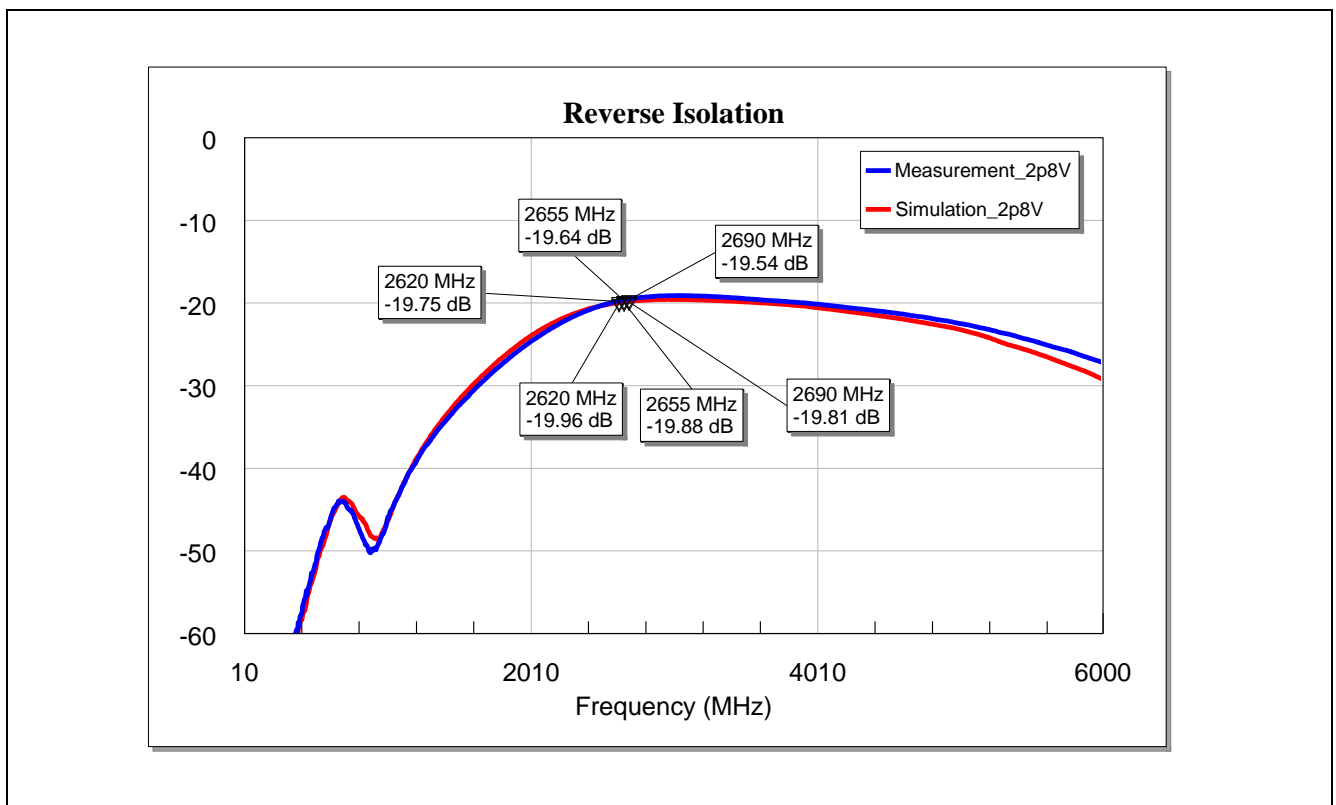

Figure 19 Reverse Isolation of the BGA7H1N6 for LTE Band-7 Application at Vcc = 2.8 V

LTE LNA for Single Band-7 Application

Measurement Graphs

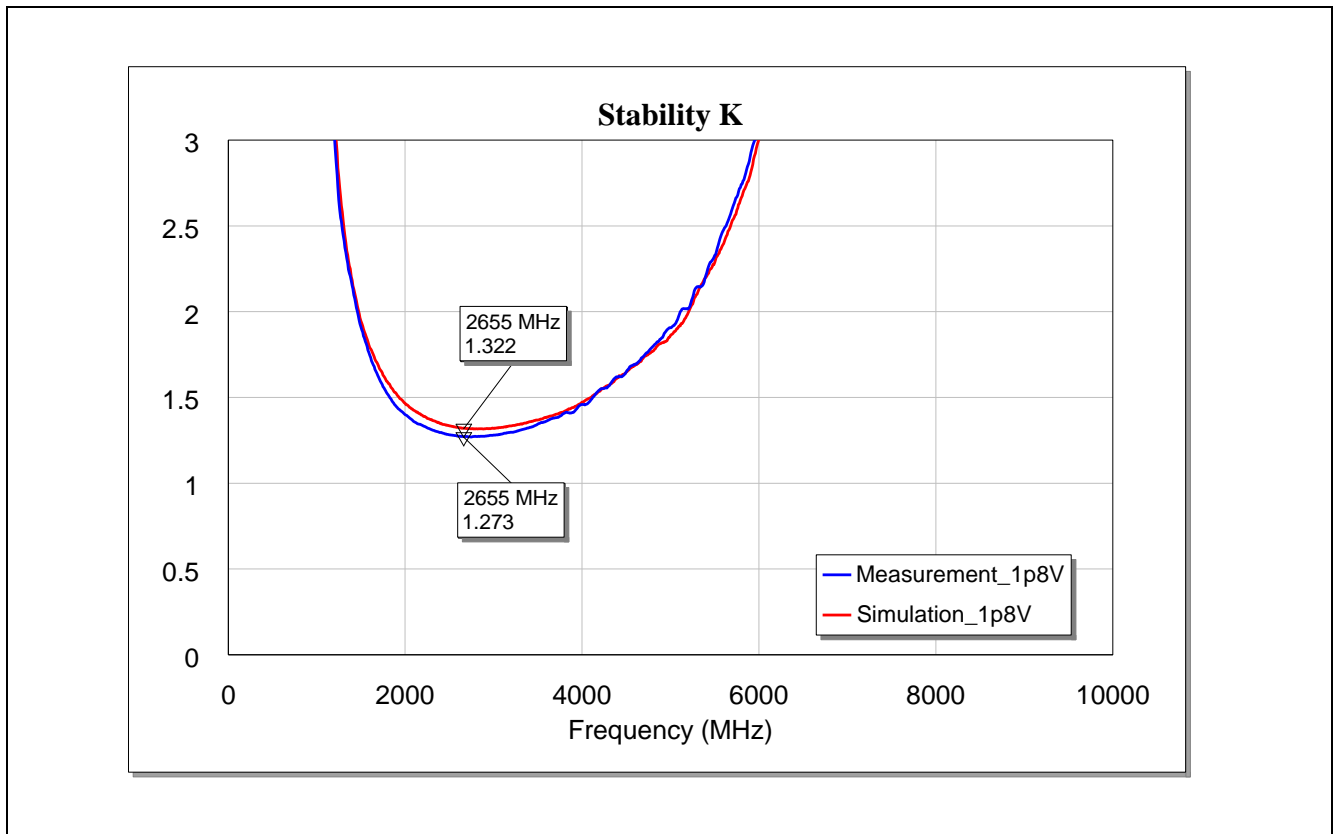

Figure 20 Stability K-factor of the BGA7H1N6 for LTE Band-7 Application at Vcc = 1.8 V

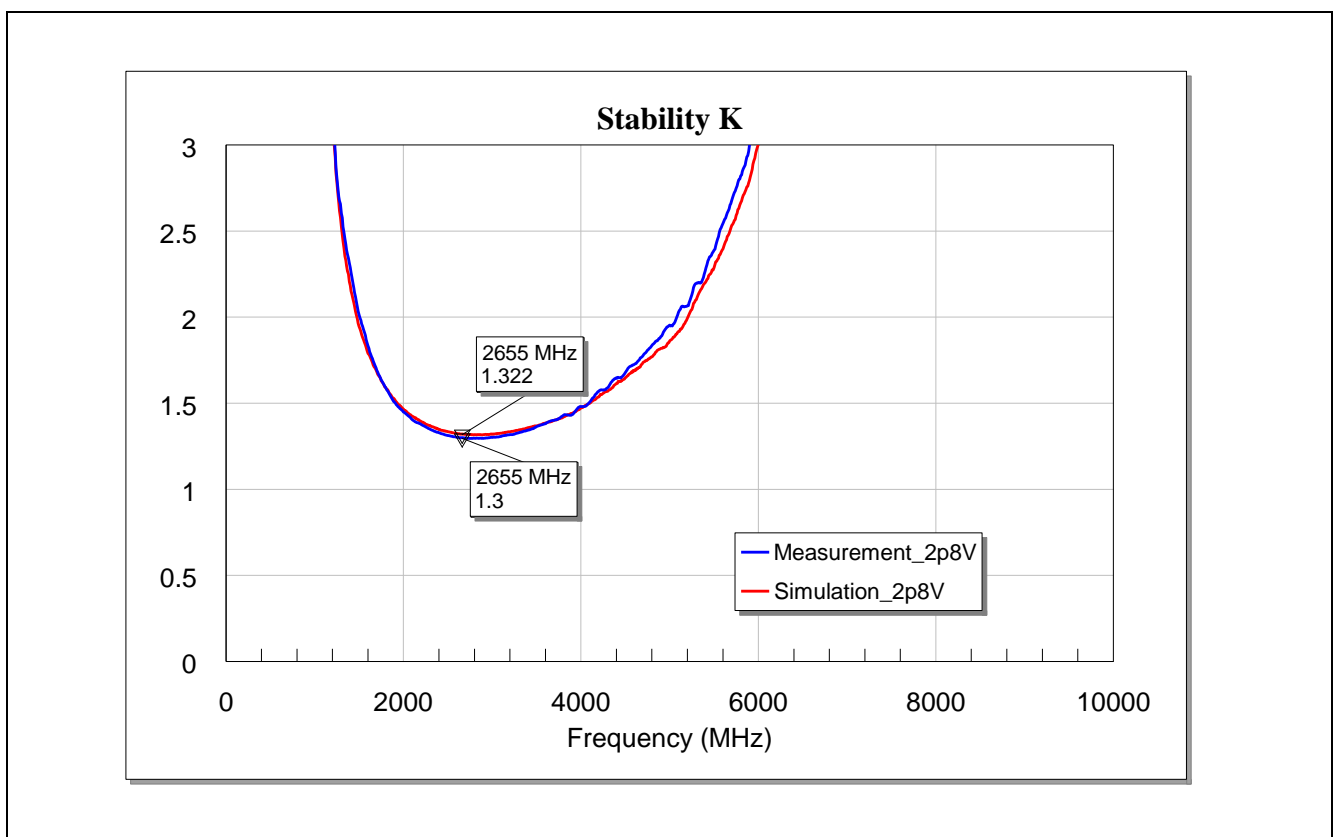

Figure 21 Stability K-factor of the BGA7H1N6 for LTE Band-7 Application at Vcc = 2.8 V

LTE LNA for Single Band-7 Application

Measurement Graphs

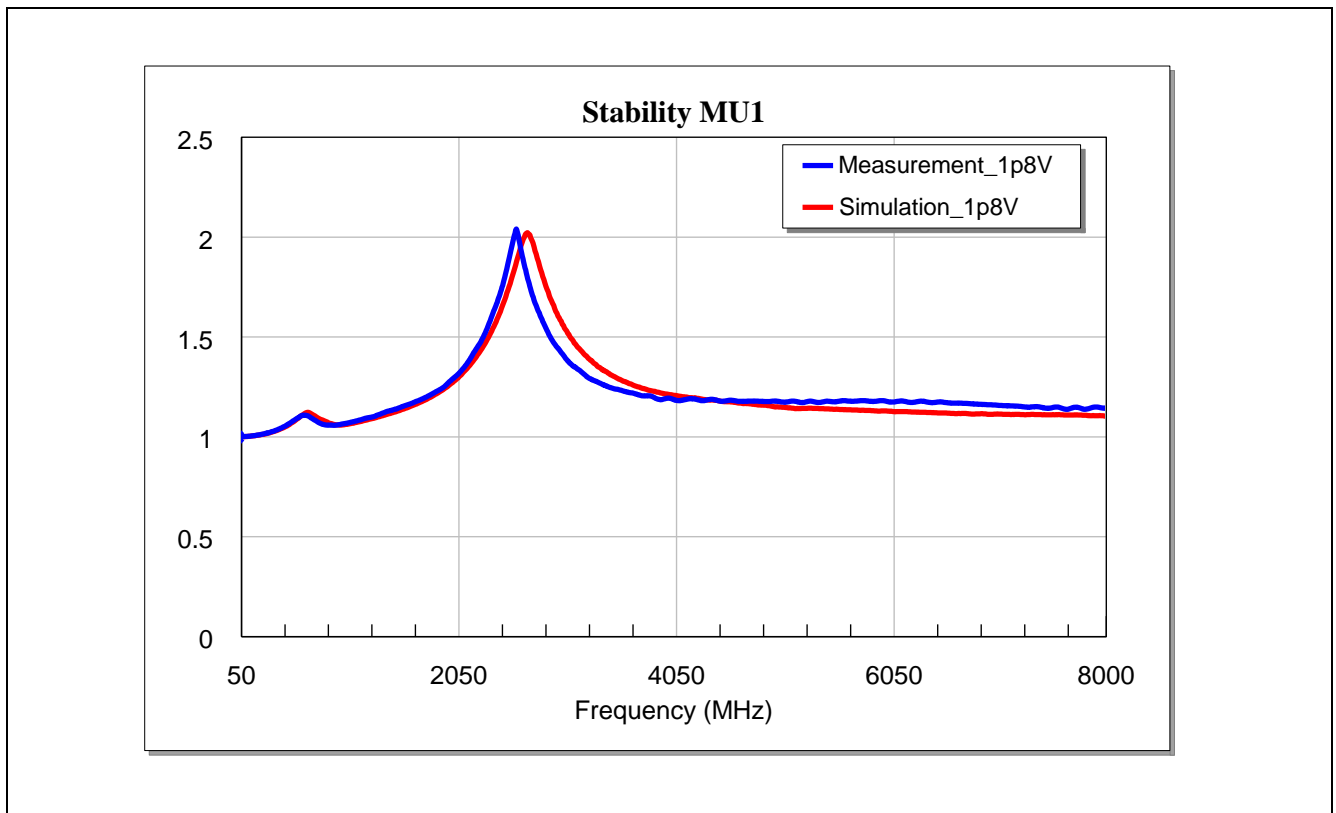

Figure 22 Stability Mu1-factor of the BGA7H1N6 for LTE Band-7 Application at Vcc = 1.8 V

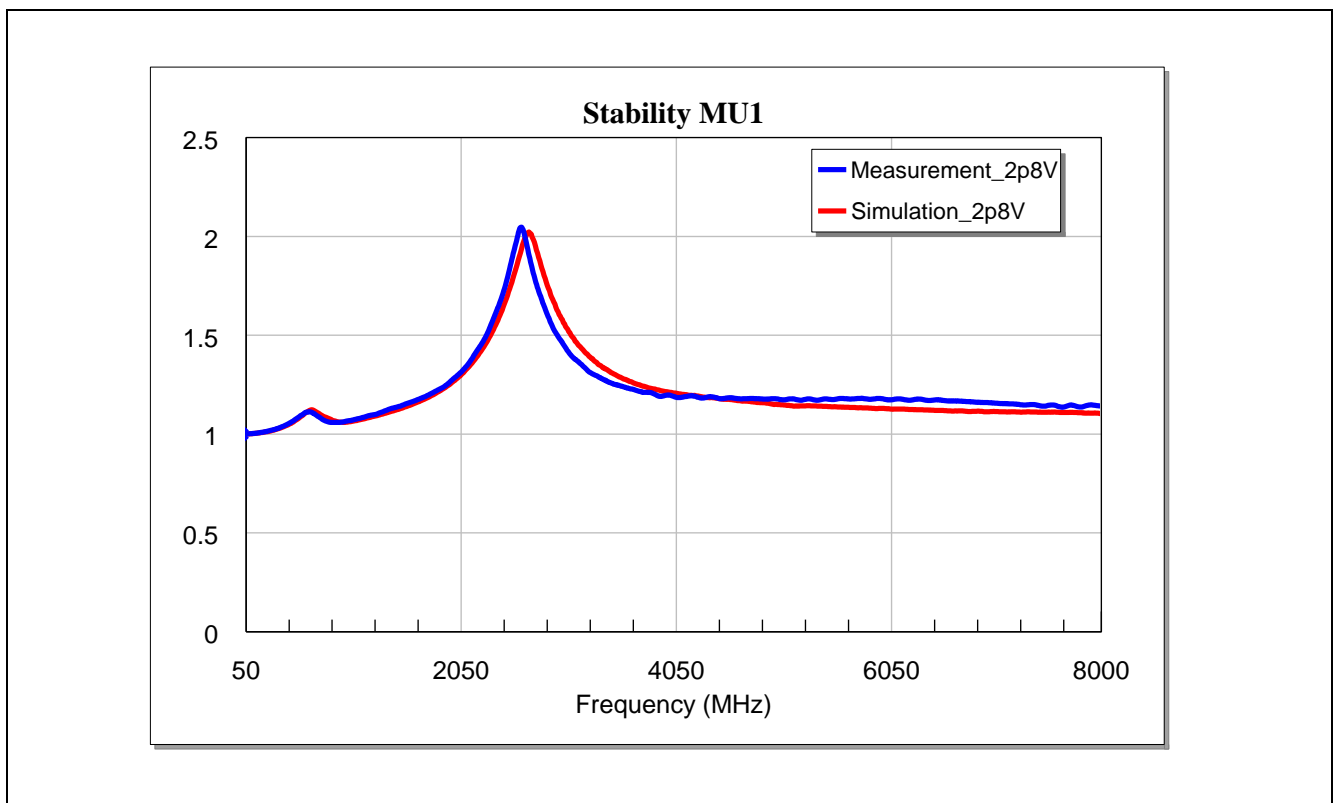

Figure 23 Stability Mu1-factor of the BGA7H1N6 for LTE Band-7 Application at Vcc = 2.8 V

LTE LNA for Single Band-7 Application

Measurement Graphs

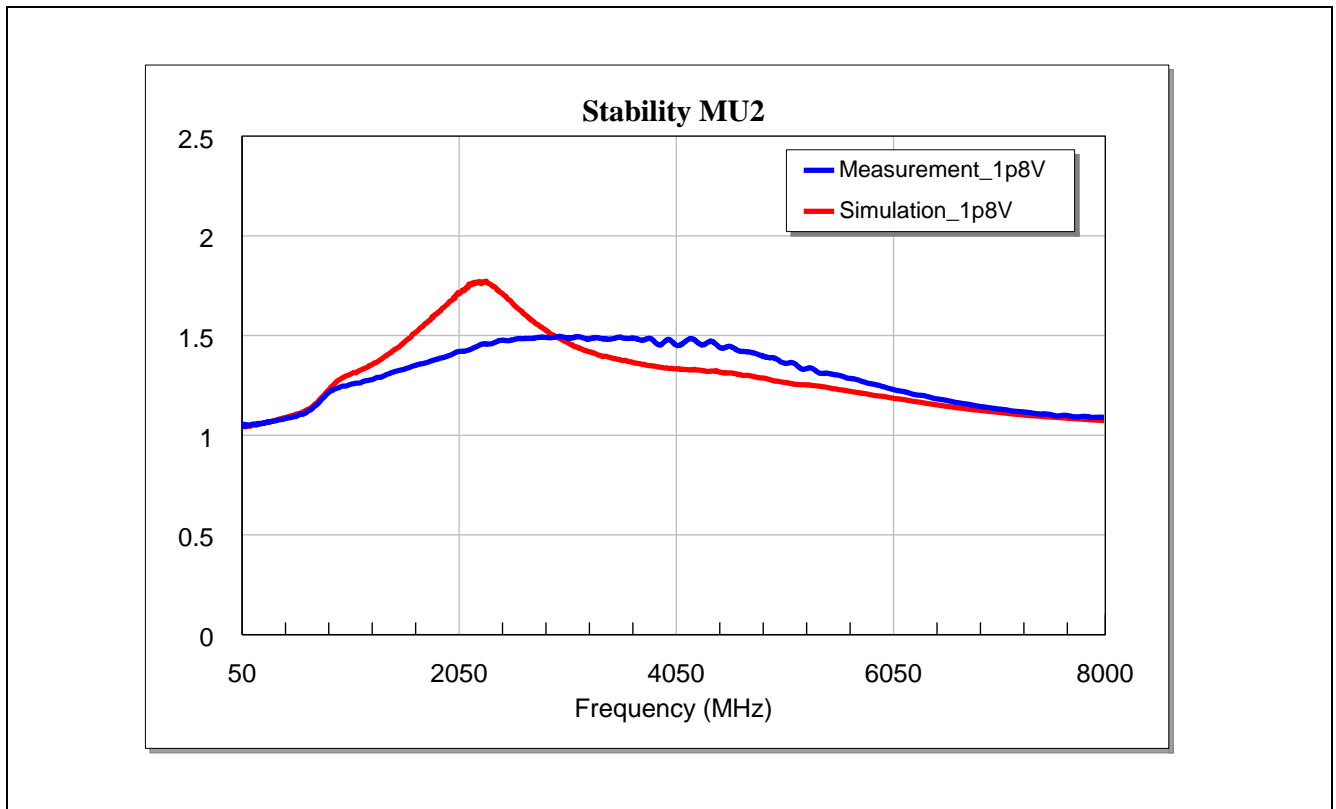

Figure 24 Stability Mu2-factor of the BGA7H1N6 for LTE Band-7 Application at Vcc = 1.8 V

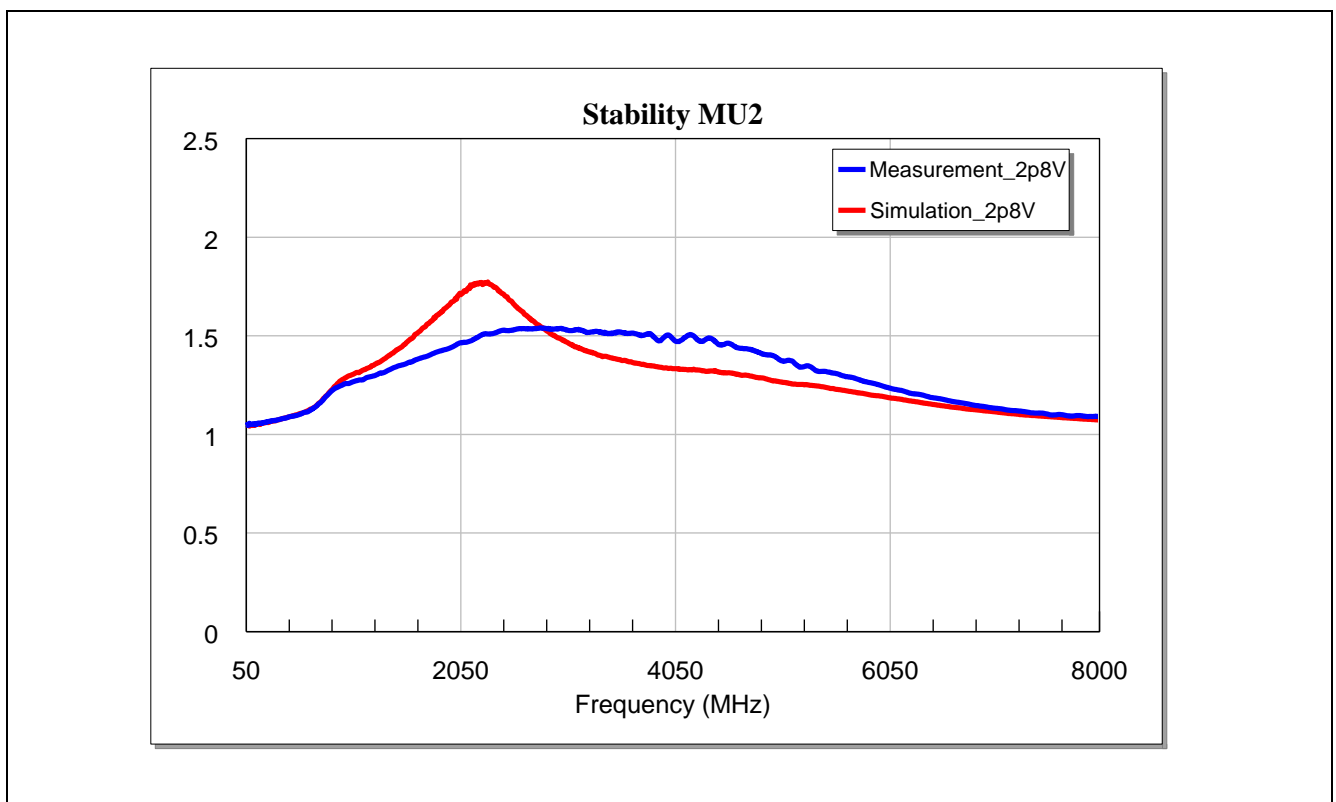

Figure 25 Stability Mu2-factor of the BGA7H1N6 for LTE Band-7 Application at Vcc = 2.8 V

LTE LNA for Single Band-7 Application

Measurement Graphs

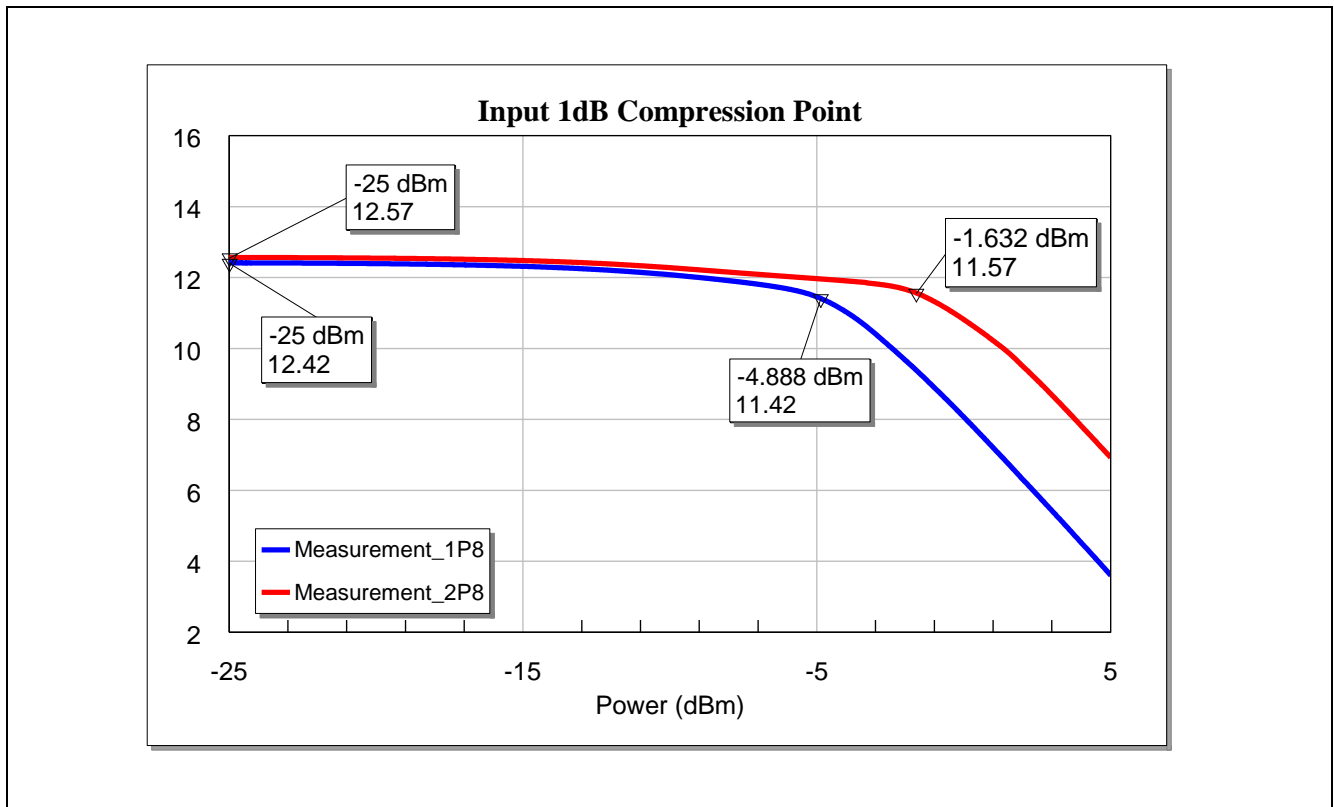

Figure 26 Input 1dB compression point of the BGA7H1N6 for LTE Band-7 Application

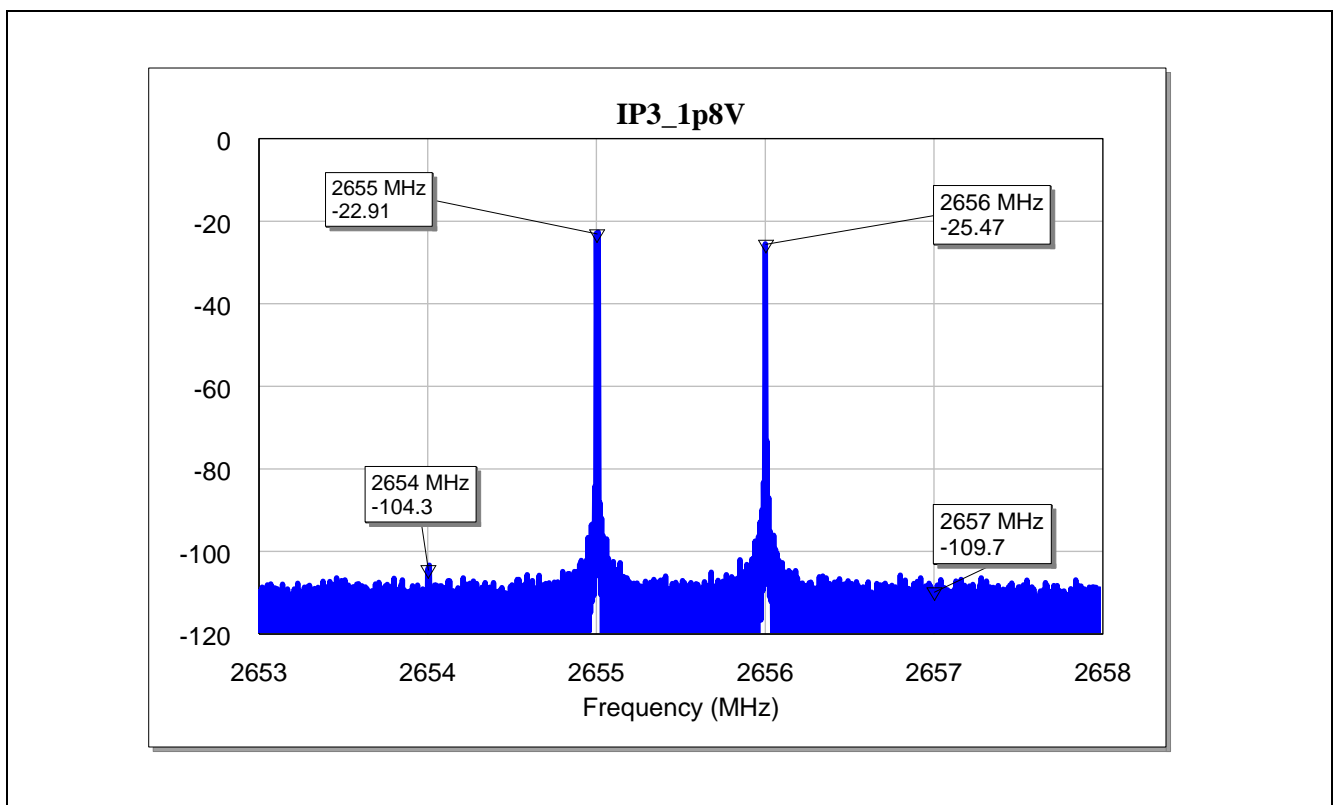

Figure 27 Input 3rd interception point of the BGA7H1N6 for LTE Band-7 Application at Vcc=1.8 V

LTE LNA for Single Band-7 Application

Measurement Graphs

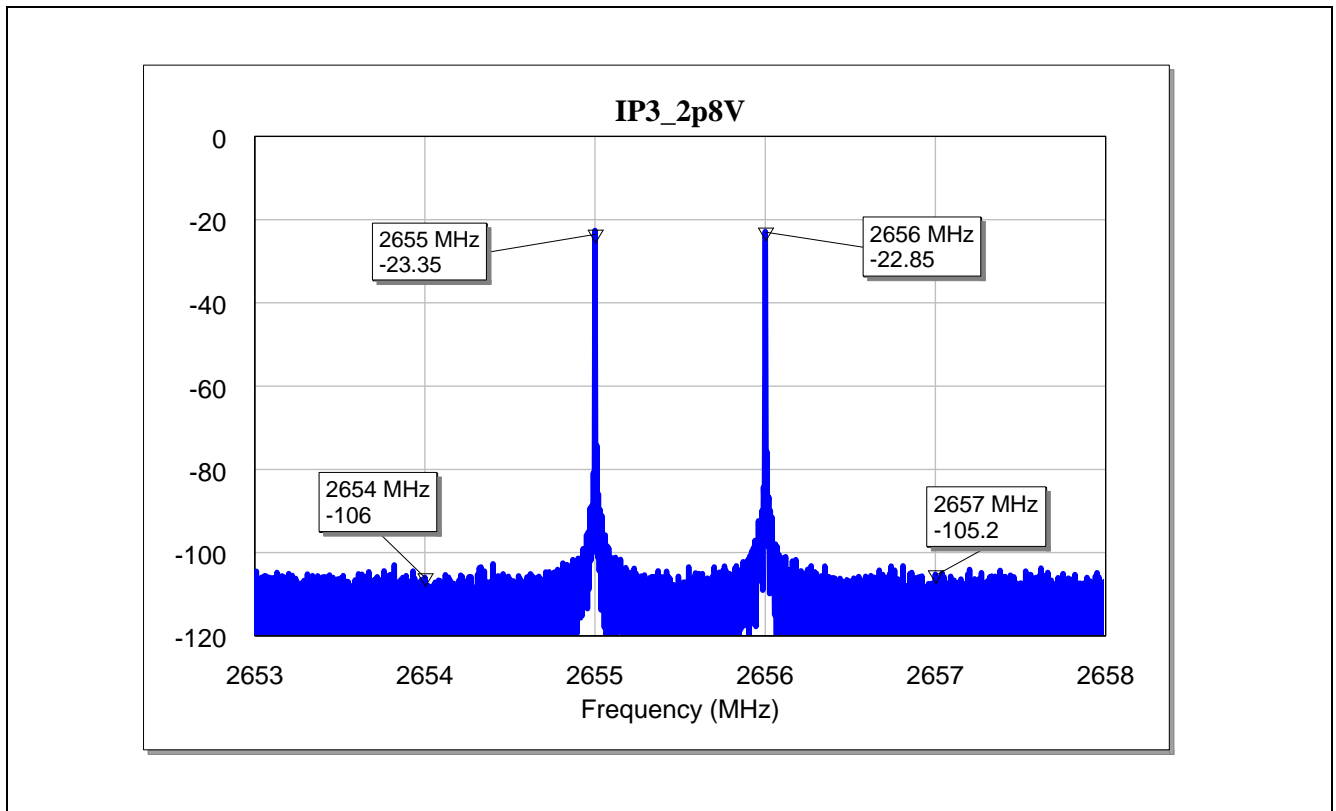

Figure 28 Input 3rd interception point of the BGA7H1N6 for LTE Band-7 Application at Vcc=2.8 V

LTE LNA for Single Band-7 Application

Evaluation Board and Layout Information

5 Evaluation Board and Layout Information

In this application note, the following PCB is used:

PCB Marking: **BGA7x1N6 V1.0**

PCB material: **Rogers 4003**

ϵ_r of PCB material: **3.6**



Figure 29 Photo of Evaluation Board (overview)

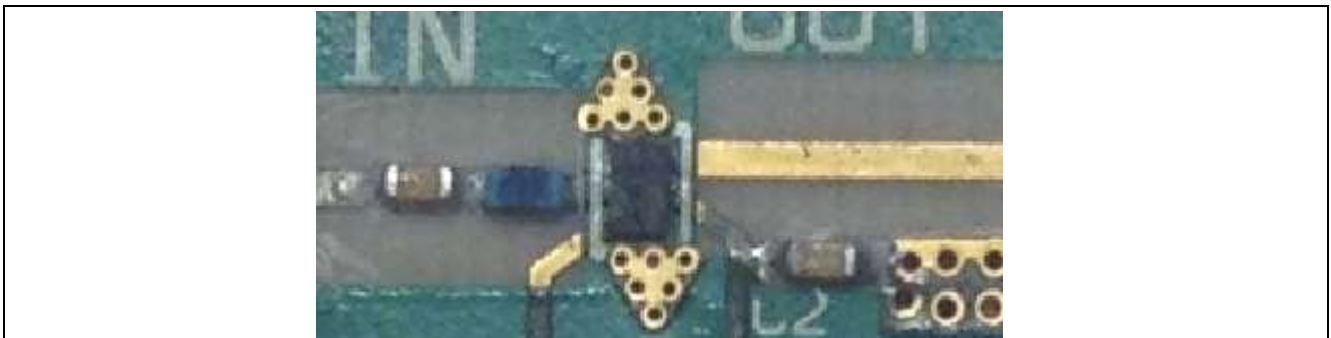

Figure 30 Photo of Evaluation Board (detailed view)

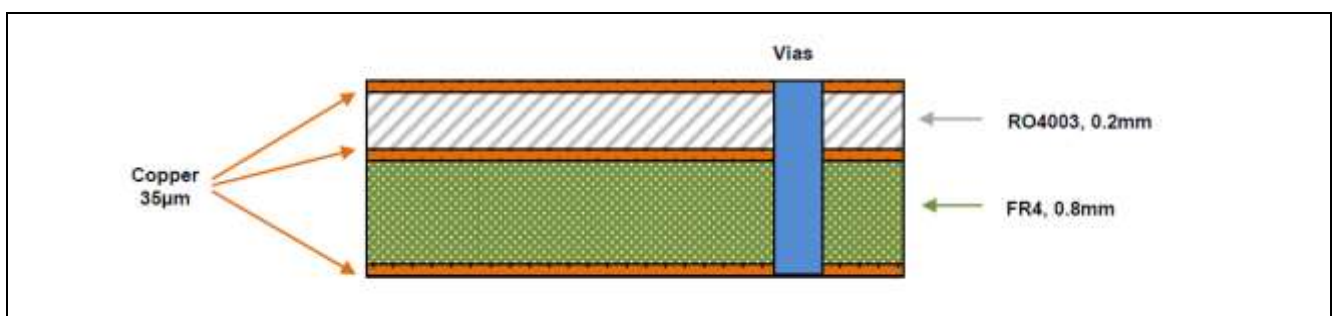

Figure 31 PCB Layer Information

6 Authors

Wenxin Pei, Working Student of Business Unit “RF and Protection Devices”

Islam Moakhkhrul, RF Application Engineer of Business Unit “RF and Protection Devices”

7 Reference

[1] A Reference. See the code examples at www.infineon.com

Revision History

Major changes since the last revision

Page or Reference	Description of change

Trademarks of Infineon Technologies AG

AURIX™, C166™, CanPAK™, CIPOS™, CIPURSE™, CoolGaN™, CoolMOS™, CoolSET™, CoolSiC™, CORECONTROL™, CROSSAVE™, DAVE™, DI-POL™, DrBLADE™, EasyPIM™, EconoBRIDGE™, EconoDUAL™, EconoPACK™, EconoPIM™, EiceDRIVER™, eupec™, FCOST™, HITFET™, HybridPACK™, ISOFACE™, IsoPACK™, i-Wafer™, MIPAQ™, ModSTACK™, my-d™, NovalithIC™, OmniTune™, OPTIGA™, OptiMOS™, ORIGA™, POWERCODE™, PRIMARION™, PrimePACK™, PrimeSTACK™, PROFET™, PRO-SiL™, RASIC™, REAL3™, ReverSave™, SatRIC™, SIEGET™, SIPMOS™, SmartLEWIS™, SOLID FLASH™, SPOC™, TEMPFET™, thinQ!™, TRENCHSTOP™, TriCore™.

Other Trademarks

Advance Design System™ (ADS) of Agilent Technologies, AMBA™, ARM™, MULTI-ICE™, KEIL™, PRIMECELL™, REALVIEW™, THUMB™, μVision™ of ARM Limited, UK. ANSI™ of American National Standards Institute. AUTOSAR™ of AUTOSAR development partnership. Bluetooth™ of Bluetooth SIG Inc. CAT-iq™ of DECT Forum. COLOSSUS™, FirstGPS™ of Trimble Navigation Ltd. EMV™ of EMVCo, LLC (Visa Holdings Inc.). EPCOS™ of Epcos AG. FLEXGO™ of Microsoft Corporation. HYPERTERMINAL™ of Hilgraeve Incorporated. MCS™ of Intel Corp. IEC™ of Commission Electrotechnique Internationale. IrDA™ of Infrared Data Association Corporation. ISO™ of INTERNATIONAL ORGANIZATION FOR STANDARDIZATION. MATLAB™ of MathWorks, Inc. MAXIM™ of Maxim Integrated Products, Inc. MICROTEC™, NUCLEUS™ of Mentor Graphics Corporation. MIPI™ of MIPI Alliance, Inc. MIPS™ of MIPS Technologies, Inc., USA. muRata™ of MURATA MANUFACTURING CO., MICROWAVE OFFICE™ (MWO) of Applied Wave Research Inc., OmniVision™ of OmniVision Technologies, Inc. Openwave™ of Openwave Systems Inc. RED HAT™ of Red Hat, Inc. RFMD™ of RF Micro Devices, Inc. SIRIUS™ of Sirius Satellite Radio Inc. SOLARIS™ of Sun Microsystems, Inc. SPANSION™ of Spansion LLC Ltd. Symbian™ of Symbian Software Limited. TAIYO YUDEN™ of Taiyo Yuden Co. TEAKLITE™ of CEVA, Inc. TEKTRONIX™ of Tektronix Inc. TOKO™ of TOKO KABUSHIKI KAISHA TA. UNIX™ of X/Open Company Limited. VERILOG™, PALLADIUM™ of Cadence Design Systems, Inc. VLYNQ™ of Texas Instruments Incorporated. VXWORKS™, WIND RIVER™ of WIND RIVER SYSTEMS, INC. ZETEX™ of Diodes Zetex Limited.

Last Trademarks Update 2014-07-17

www.infineon.com

Edition 2014-11-19

Published by

Infineon Technologies AG

81726 Munich, Germany

© 2015 Infineon Technologies AG.

All Rights Reserved.

Do you have a question about any aspect of this document?

Email: erratum@infineon.com

Document reference

AN_201412_PL32_004

Legal Disclaimer

THE INFORMATION GIVEN IN THIS APPLICATION NOTE (INCLUDING BUT NOT LIMITED TO CONTENTS OF REFERENCED WEBSITES) IS GIVEN AS A HINT FOR THE IMPLEMENTATION OF THE INFINEON TECHNOLOGIES COMPONENT ONLY AND SHALL NOT BE REGARDED AS ANY DESCRIPTION OR WARRANTY OF A CERTAIN FUNCTIONALITY, CONDITION OR QUALITY OF THE INFINEON TECHNOLOGIES COMPONENT. THE RECIPIENT OF THIS APPLICATION NOTE MUST VERIFY ANY FUNCTION DESCRIBED HEREIN IN THE REAL APPLICATION. INFINEON TECHNOLOGIES HEREBY DISCLAIMS ANY AND ALL WARRANTIES AND LIABILITIES OF ANY KIND (INCLUDING WITHOUT LIMITATION WARRANTIES OF NON-INFRINGEMENT OF INTELLECTUAL PROPERTY RIGHTS OF ANY THIRD PARTY) WITH RESPECT TO ANY AND ALL INFORMATION GIVEN IN THIS APPLICATION NOTE.

Information

For further information on technology, delivery terms and conditions and prices, please contact the nearest Infineon Technologies Office (www.infineon.com).

Warnings

Due to technical requirements, components may contain dangerous substances. For information on the types in question, please contact the nearest Infineon Technologies Office. Infineon Technologies components may be used in life-support devices or systems only with the express written approval of Infineon Technologies, if a failure of such components can reasonably be expected to cause the failure of that life-support device or system or to affect the safety or effectiveness of that device or system. Life support devices or systems are intended to be implanted in the human body or to support and/or maintain and sustain and/or protect human life. If they fail, it is reasonable to assume that the health of the user or other persons may be endangered.