

BFQ790

**Driver Amplifier for LTE Band-7
(2620 - 2690 MHz) Applications**

Application Note AN385

Revision: Rev. 1.0
2014-07-31

Application Note AN385

Revision History: 2014-07-31

Previous Revision:

Page	Subjects (major changes since last revision)

Trademarks of Infineon Technologies AG

AURIX™, C166™, CanPAK™, CIPOS™, CIPURSE™, EconoPACK™, CoolMOS™, CoolSET™, CORECONTROL™, CROSSAVE™, DAVE™, DI-POL™, EasyPIM™, EconoBRIDGE™, EconoDUAL™, EconoPIM™, EconoPACK™, EiceDRIVER™, eupec™, FCOS™, HITFET™, HybridPACK™, I²RF™, ISOFACE™, IsoPACK™, MIPAQ™, ModSTACK™, my-d™, NovalithIC™, OptiMOS™, ORIGA™, POWERCODE™, PRIMARION™, PrimePACK™, PrimeSTACK™, PRO-SIL™, PROFET™, RASIC™, ReverSave™, SatRIC™, SIEGET™, SINDRION™, SIPMOS™, SmartLEWIS™, SOLID FLASH™, TEMPFET™, thinQ!™, TRENCHSTOP™, TriCore™.

Other Trademarks

Advance Design System™ (ADS) of Agilent Technologies, AMBA™, ARM™, MULTI-ICE™, KEIL™, PRIMECELL™, REALVIEW™, THUMB™, μVision™ of ARM Limited, UK. AUTOSAR™ is licensed by AUTOSAR development partnership. Bluetooth™ of Bluetooth SIG Inc. CAT-ig™ of DECT Forum. COLOSSUS™, FirstGPS™ of Trimble Navigation Ltd. EMV™ of EMVCo, LLC (Visa Holdings Inc.). EPCOS™ of Epcos AG. FLEXGO™ of Microsoft Corporation. FlexRay™ is licensed by FlexRay Consortium. HYPERTERMINAL™ of Hilgraeve Incorporated. IEC™ of Commission Electrotechnique Internationale. IrDA™ of Infrared Data Association Corporation. ISO™ of INTERNATIONAL ORGANIZATION FOR STANDARDIZATION. MATLAB™ of MathWorks, Inc. MAXIM™ of Maxim Integrated Products, Inc. MICROTEC™, NUCLEUS™ of Mentor Graphics Corporation. MIPI™ of MIPI Alliance, Inc. MIPS™ of MIPS Technologies, Inc., USA. muRata™ of MURATA MANUFACTURING CO., MICROWAVE OFFICE™ (MWO) of Applied Wave Research Inc., OmniVision™ of OmniVision Technologies, Inc. Openwave™ Openwave Systems Inc. RED HAT™ Red Hat, Inc. RFMD™ RF Micro Devices, Inc. SIRIUS™ of Sirius Satellite Radio Inc. SOLARIS™ of Sun Microsystems, Inc. SPANSION™ of Spansion LLC Ltd. Symbian™ of Symbian Software Limited. TAIYO YUDEN™ of Taiyo Yuden Co. TEAKLITE™ of CEVA, Inc. TEKTRONIX™ of Tektronix Inc. TOKO™ of TOKO KABUSHIKI KAISHA TA. UNIX™ of X/Open Company Limited. VERILOG™, PALLADIUM™ of Cadence Design Systems, Inc. VLYNQ™ of Texas Instruments Incorporated. VXWORKS™, WIND RIVER™ of WIND RIVER SYSTEMS, INC. ZETEX™ of Diodes Zetex Limited.

Last Trademarks Update 2011-11-11

Table of Content

1	Introduction	5
1.1	Overview of LTE-Advanced Small Cell Base Stations.....	5
1.2	Infineon Driver Amplifier Family	6
2	BFQ790 Overview	8
2.1	Features	8
2.2	Key Applications of BFQ790	8
3	BFQ790 Driver Amplifier Application Circuit for LTE Band-7 Applications (2620 – 2690 MHz).9	
3.1	Performance Overview.....	9
3.2	Schematics and Bill-of-Materials.....	10
4	Measurement Graphs	11
5	Evaluation Board and Layout Information	17
6	Authors.....	18
7	Remark	18

List of Figures

Figure 1	A RF Front-End Block Diagram Example of WiFi Enabled LTE Small Cell	6
Figure 2	BFQ790 in SOT89.....	8
Figure 3	Schematics of the BFQ790 Application Circuit for LTE Band-7 (2620 - 2690 MHz)	10
Figure 4	Wideband Insertion Power Gain of the BFQ790 for Band-7 Applications	11
Figure 5	Narrowband Insertion Power Gain of the BFQ790 for Band-7 Applications	11
Figure 6	Input Matching of the BFQ790 for Band-7 Applications.....	12
Figure 7	Input Matching (Smith Chart) of the BFQ790 for Band-7 Applications	12
Figure 8	Output Matching of the BFQ790 for Band-7 Applications	13
Figure 9	Output Matching (Smith Chart) of the BFQ790 for Band-7 Applications	13
Figure 10	Reverse Isolation of the BFQ790 for Band-7 Applications	14
Figure 11	Output 1dB Compression Point of the BFQ790 for Band-7 Applications.....	14
Figure 12	Carrier to IM3 Ratio of the BFQ790 for Band-7 Applications.....	15
Figure 13	DC Current Consumption versus Output Power of the BFQ790 for Band-7 Applications	15
Figure 14	Stability Mu1, Mu2-factors of the BFQ790 for Band-7 Applications.....	16
Figure 15	Photo of Evaluation Board of the BFQ790 Application Circuit for LTE Band-7 Application.....	17
Figure 16	PCB Layer Stack.....	17

List of Tables

Table 1	Small Cell Family Classification	5
Table 2	Summary of Measurement Results.....	9
Table 3	Bill-of-Materials.....	10

1 Introduction

1.1 Overview of LTE-Advanced Small Cell Base Stations

Mobile communication technologies have seen tremendous growth in recent years. In order to satisfy the rising demand of the next level of wireless data capacity, small cells, which are fully featured, short range mobile phone basestations, are gathering more and more focus to increase wireless network capacity and reduce network costs.

The main capacity enhancement of small cells is the result from aggressive frequency re-use. Meanwhile, small cells are placed much closer to the mobile device users, especially for the indoor applications. Due to the small cells installed indoor, the heavy signal losses across the walls of buildings between indoor user and outdoor LTE macrocell network can be avoided. Data rates increase with the improved signal strength and signal quality. The uplink power from the mobile devices also decreases at the same time, which extends the mobile device battery lifetime. Compared to leased lines for macrocell network backhaul, the public internet can be served as small cells backhaul to decrease the backhaul costs. Meanwhile, small cells are much more flexible to be installed and more easily deployed than a typical macro base station, providing cost savings for operators.

Small cell family comprises femtocells, picocells, and microcells, depending on the variety of capacity and power ranges. **Table 1** lists the small cell family classification.

Table 1 Small Cell Family Classification

Small Cell Category	Output Average Power (dBm)	Maximum Cell Radius (m)	Wireless Standard
Femtocell	10–13	10	3G/4G/WiFi
Picocell	24–30	200	3G/4G
Microcell	30–37	2000	2G/3G/4G

The small cell can be divided into two distinct function blocks: the RF front-end and the baseband processor. The block diagram is presented in **Figure 1**. The RF front-end converts the baseband data into a RF radiated signal in the transmit circuit, and vice versa in the receive chain.

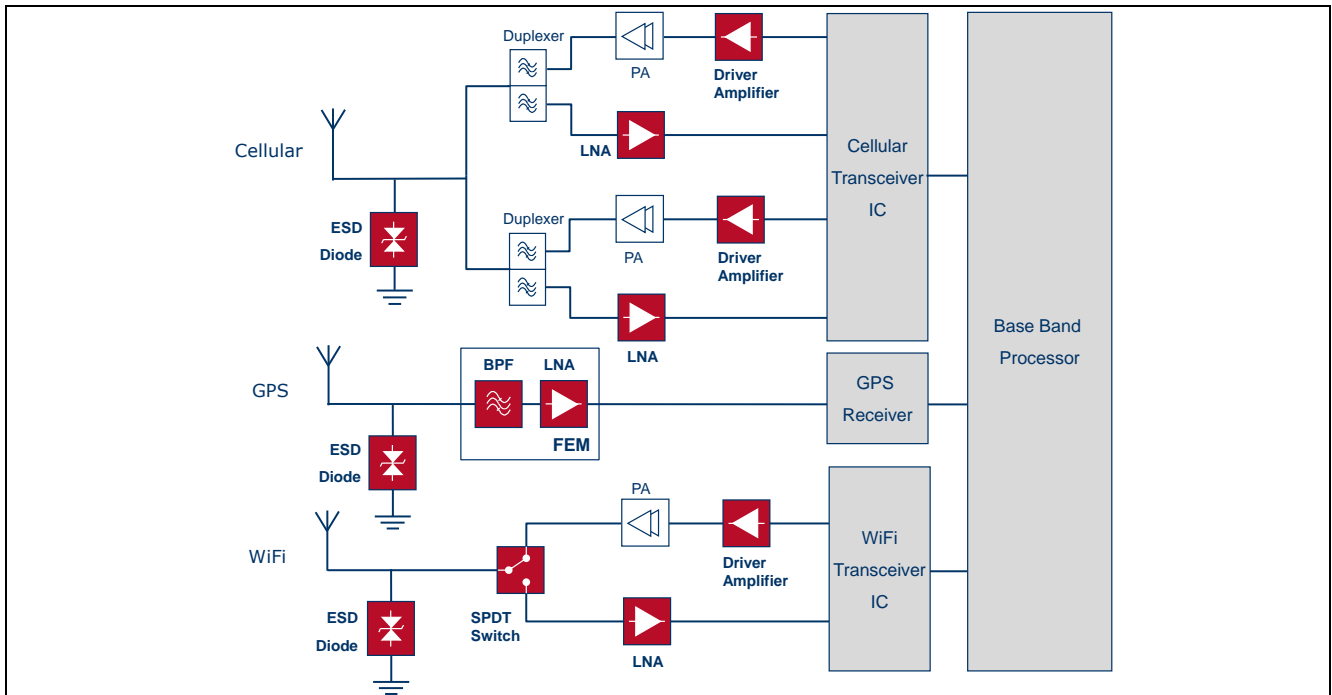

Figure 1 A RF Front-End Block Diagram Example of WiFi Enabled LTE Small Cell

Infineon Technologies is the leading company with a broad portfolio of RF product solutions including driver amplifiers, low noise amplifiers (LNAs), switches, ESD protection diodes and GNSS module for mobile phone as well as for small cell base transceiver station (BTS) applications.

1.2 Infineon Driver Amplifier Family

The driver amplifier, also known as gain block, is an important functional block in RF transceiver systems requiring high output power. The Power Amplifier (PA), the final stage of a signal amplifier chain, requires a certain input power level to operate in the linear mode, which usually cannot be delivered by the transceiver IC directly. In these cases, external one or two stage driver amplifiers are required. Driver amplifiers are generally operated in linear class-A mode to enable high linearity and high gain, thereby keeping spurious signals generated by the PA low, by reducing intermodulation products. Class-A amplifiers are also the right choice for broadband operation at low power levels.

BFQ790 and BFP780 are described as general purpose medium power transistor in Infineon's Silicon Germanium (SiGe) product portfolio for wireless infrastructure applications. These include mobile basestation transceivers, cellular repeaters, ISM band amplifiers and

test equipment. Their operating frequency range can be as high as 3.6 GHz, and the application circuit can be optimized for specific frequency bands with external matching components.

The BFQ790 is a single stage driver amplifier with very high linearity. Its output 1dB compression point is 27 dBm. The device is housed in the halogen-free industry standard package SOT89. The high thermal conductivity of silicon substrate and the low thermal resistance of the package add up to a thermal resistance of only 35 K/W, which leads to moderate junction temperatures even at high dissipated power values. The proper die attach with good thermal contact is 100% tested, so that there is minimum variation of thermal properties. The device is based on Infineon's reliable and cost effective NPN SiGe technology running in high volume. The collector design allows safe operation with 5 V supply voltage. The BFQ790 is very rugged. A special collector design prevents from thermal runaway respectively 2nd breakdown, which leads to a high ruggedness against mismatch at the output. The special design of the emitter/base diode makes it robust and yields to a high maximum RF input power capability.

The BFP780 is a single stage driver amplifier with high linearity and high power gain. Its output 1dB compression point is 22 dBm. The chip is housed in a halogen-free industry standard package SOT343. The proper die attach with good thermal contact is 100% tested and verified. Same as BFQ790, the device is based on Infineon's reliable and cost effective NPN SiGe technology running in high volume. The collector design allows safe operation with 5 V supply voltage. For further information about BFP780 please refer its datasheet and application.

In this application note, the driver application circuit of BFQ790 for LTE Band-7 (2620 - 2690 MHz) and its measurement results are presented. The BFQ790 driver provides 14.0 dB gain in the frequency range of 2620 to 2690 MHz. The output 1dB compression point (OP1dB) is 27 dBm measured at 2650 MHz. Besides, in two-tone test with tone spacing of 1 MHz, the output third order intercept point (OIP3) reaches 41 dBm and the carrier to the 3rd IM product ratio (CIMR3) is larger than 50 dBc when the signal power per tone reaches 15.5 dBm.

2 BFQ790 Overview

2.1 Features

- High 3rd order intercept point OIP3 of 38.5 dBm @ 2600 MHz, 5 V, 250 mA (measured in test board, 41 dBm in application)
- High compression point OP1dB of 27 dBm @ 2600 MHz, 5 V, 250 mA, corresponding to 40% collector efficiency
- High maximum power gain $G_{max}=16$ dB @ 2600 MHz, 5 V, 250 mA
- Low minimum noise figure of 2.6 dB @ 1800 MHz, 5 V, 70 mA
- Single stage, intended for external matching
- Very rugged: Worst case output mismatch VSWR 10:1
- High maximum RF input power PRFinmax of 18 dBm
- Safe operation with single 5 V supply
- 100% test of proper die attach for reproducible thermal contact
- 100% DC and RF tested
- Easy to use large signal compact (VBIC) model available
- Cost effective NPN SiGe technology running in very high volume
- Easy to use Pb-free (RoHS compliant) and halogen-free industry standard package SOT89, low RthJS of 35 K/W



Figure 2 BFQ790 in SOT89



2.2 Key Applications of BFQ790

As

- High linearity driver or pre-driver in the transmit chain
- 2nd or 3rd stage LNA in the receive chain
- IF or LO buffer amplifier

In

- Commercial / industrial wireless infrastructure / basestations
- Repeaters
- Automated test equipment

For

- Cellular, PCS, DCS, UMTS, LTE, CDMA, WCDMA, GSM, GPRS
- WLAN, WiMAX, WLL and MMDS
- ISM, AMR
- UHF television, CATV, DBS

Attention: ESD (Electrostatic discharge) sensitive device, observe handling precautions

3 BFQ790 Driver Amplifier Application Circuit for LTE Band-7 Applications (2620 – 2690 MHz)

3.1 Performance Overview

Device: BFQ790

Application: Driver Amplifier for LTE Band-7 (2620 - 2690 MHz) Applications

PCB Marking: DRIVER SOT89 V8.0 M130807-89

Table 2 Summary of Measurement Results

Parameter	Symbol	Value	Unit	Comment/Test Condition
DC Voltage	VCC	5.0	V	
Quiescent DC Current	ICq	220	mA	
Frequency Range	Freq	2620 – 2690	MHz	
Gain	G	14.0	dB	Vcc= 5.0 V, Icc= 230 mA, the PCB and SMA losses are not subtracted.
Input Return Loss	RLin	>10	dB	
Output Return Loss	RLout	>10	dB	
Reverse Isolation	IRev	23	dB	
Output P1dB	OP1dB	27	dBm	Measured at 2.65 GHz
Output IP3	OIP3	41	dBm	Power @ output: 14 dBm per tone $f_1=2650$ MHz, $f_2=2651$ MHz
Stability	μ_1, μ_2	> 1	--	Measured up to 6 GHz

Note: Please refer to **Chapter 4** for corresponding graphs

3.2 Schematics and Bill-of-Materials

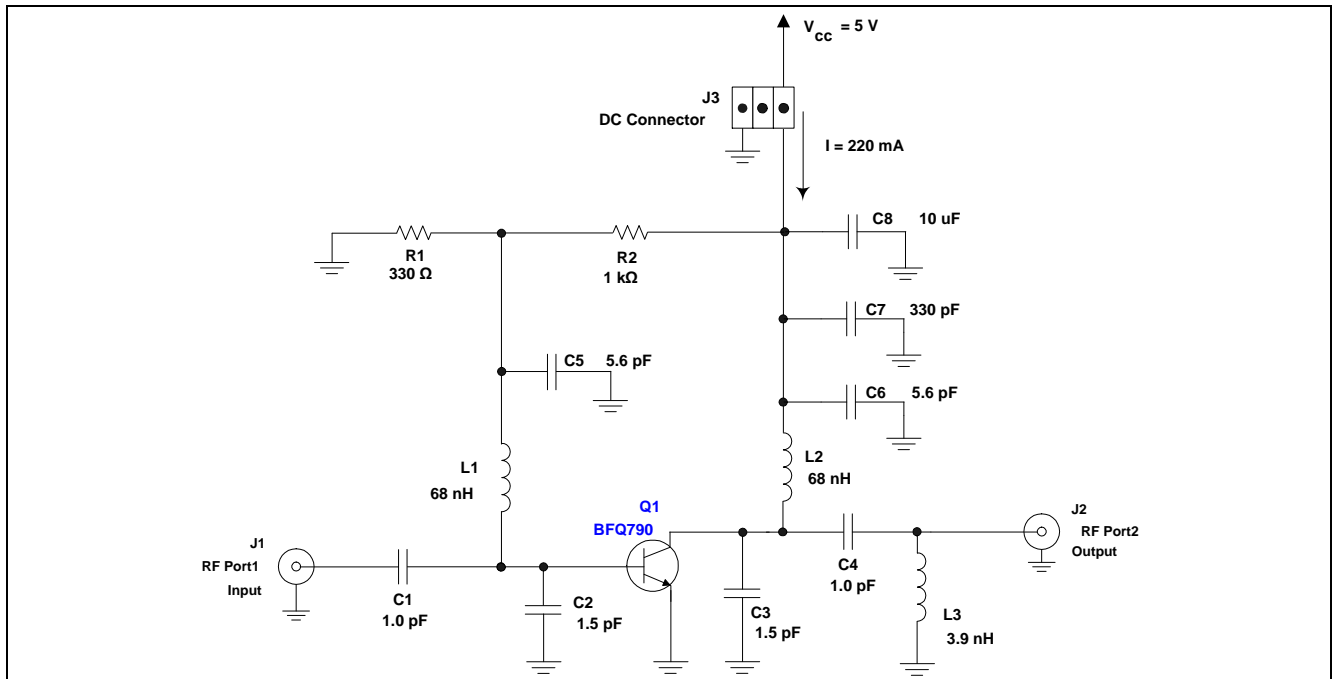

Figure 3 Schematics of the BFQ790 Application Circuit for LTE Band-7 (2620 - 2690 MHz)

Table 3 Bill-of-Materials

Symbol	Value	Unit	Size	Manufacturer	Comment
Q1	BFQ790	SOT89		Infineon	SiGe driver transistor
C1	1.0	pF	0603	Various	Input matching and DC blocking
C2	1.5	pF	0603	Various	Input matching
C3	1.5	pF	0603	Murata LQW series	Output matching
C4	1.0	pF	0603	Various	Output matching and DC blocking
C5	5.6	nF	0603	Various	RF bypass
C6	5.6	pF	0603	Various	RF bypass
C7	330	pF	0603	Various	RF bypass
C8	10	μF	0603	Various	RF bypass
L1	68	nH	0603	Murata LQW series	RF choke
L2	68	nH	0603	Murata LQW series	RF choke
L3	3.9	nH	0603	Murata LQW series	Output matching
R1	330	Ω	0603	Various	DC biasing
R2	1.0	kΩ	0603	Various	DC biasing

4 Measurement Graphs

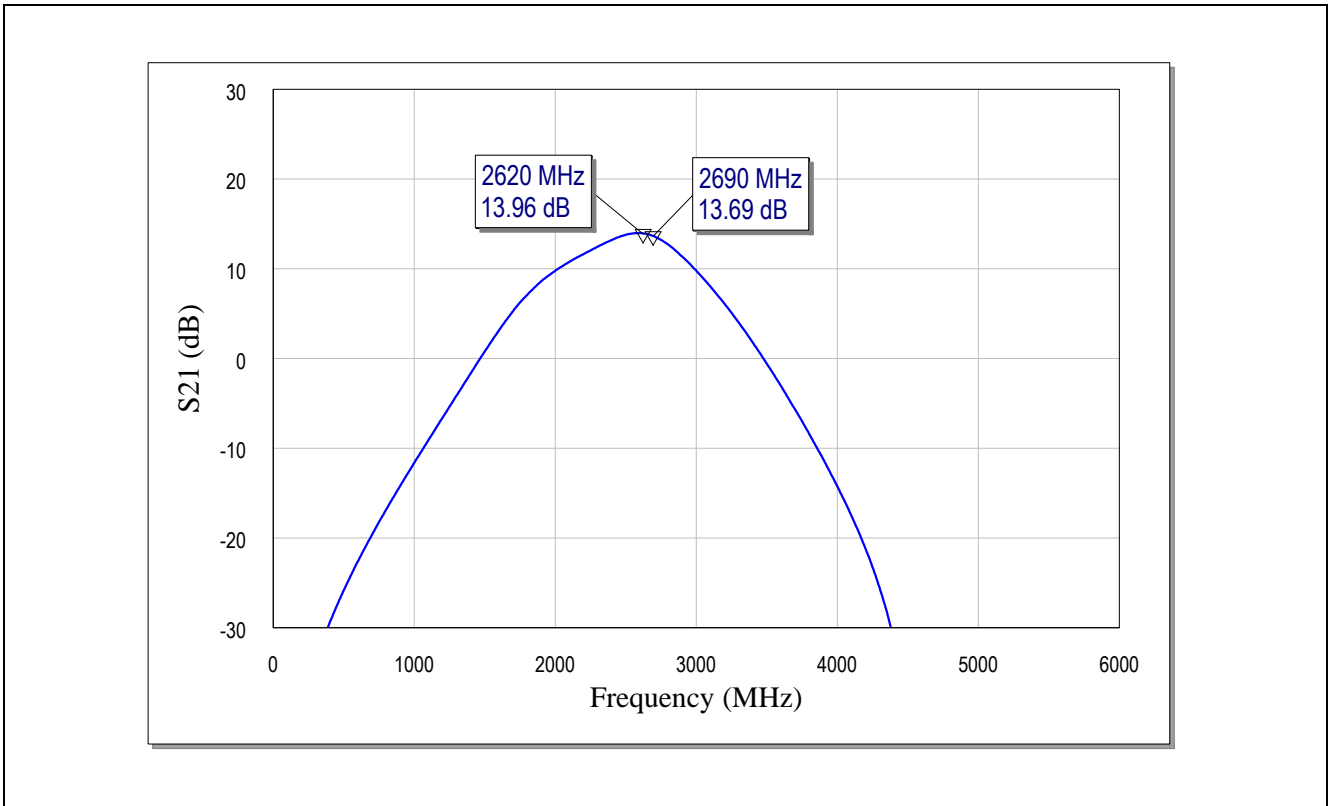

Figure 4 Wideband Insertion Power Gain of the BFQ790 for Band-7 Applications

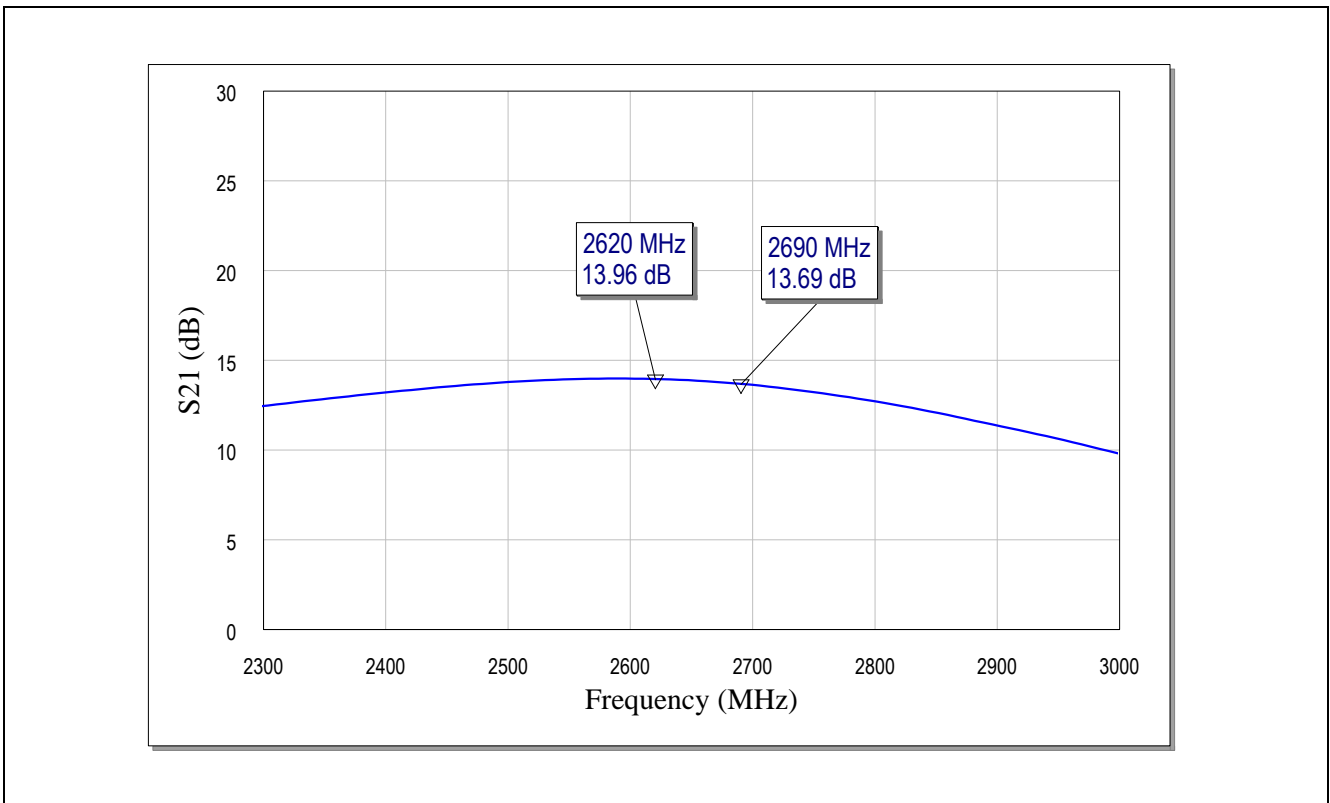

Figure 5 Narrowband Insertion Power Gain of the BFQ790 for Band-7 Applications

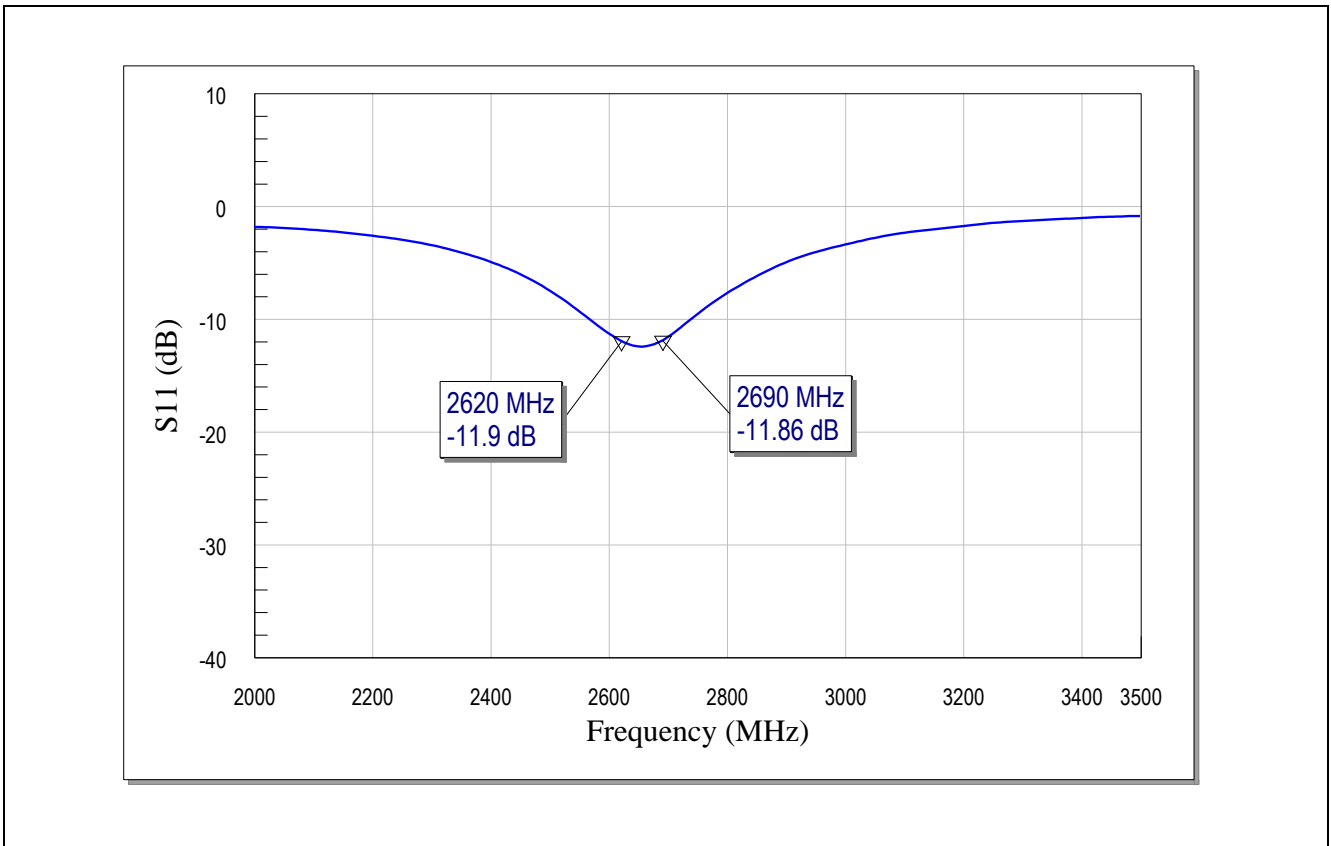

Figure 6 Input Matching of the BFQ790 for Band-7 Applications

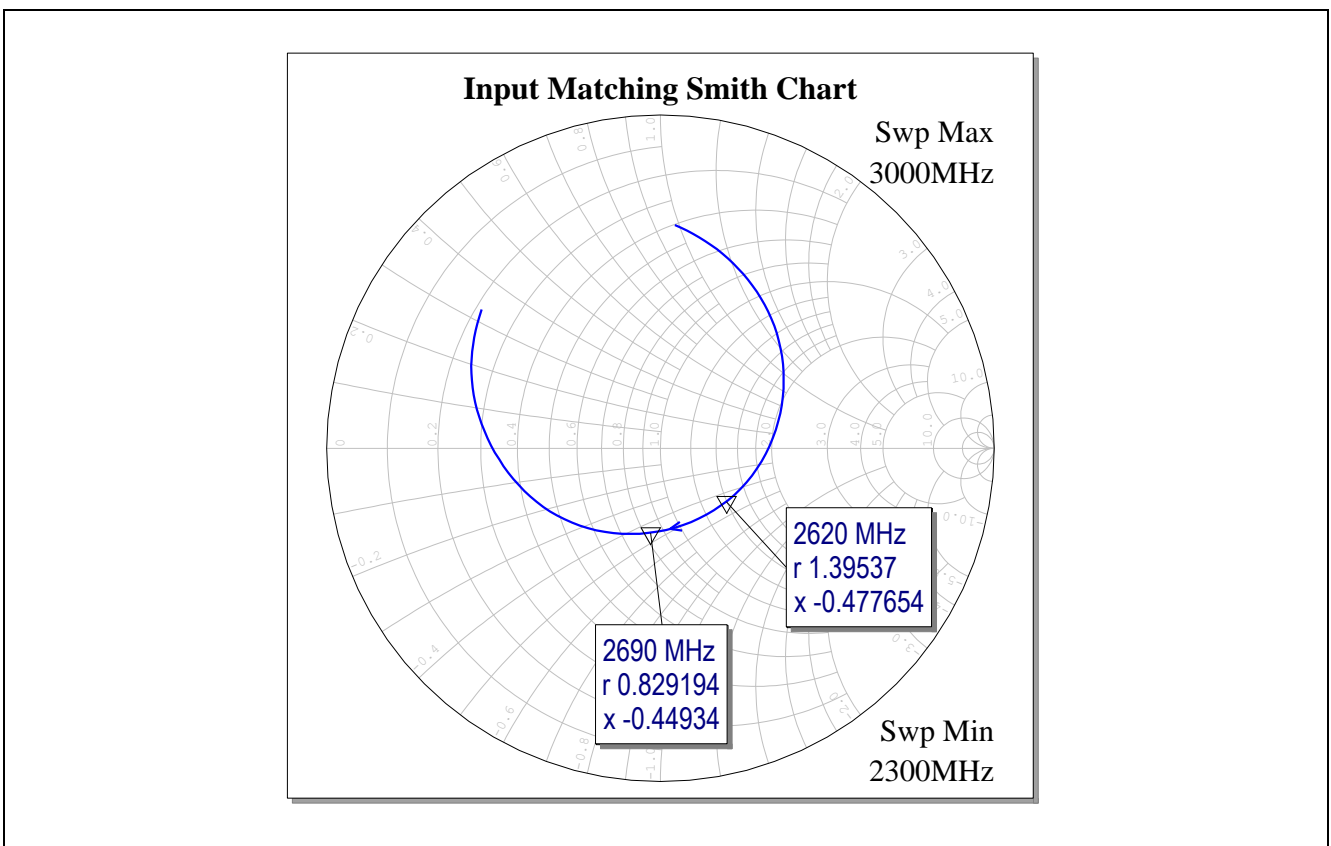

Figure 7 Input Matching (Smith Chart) of the BFQ790 for Band-7 Applications

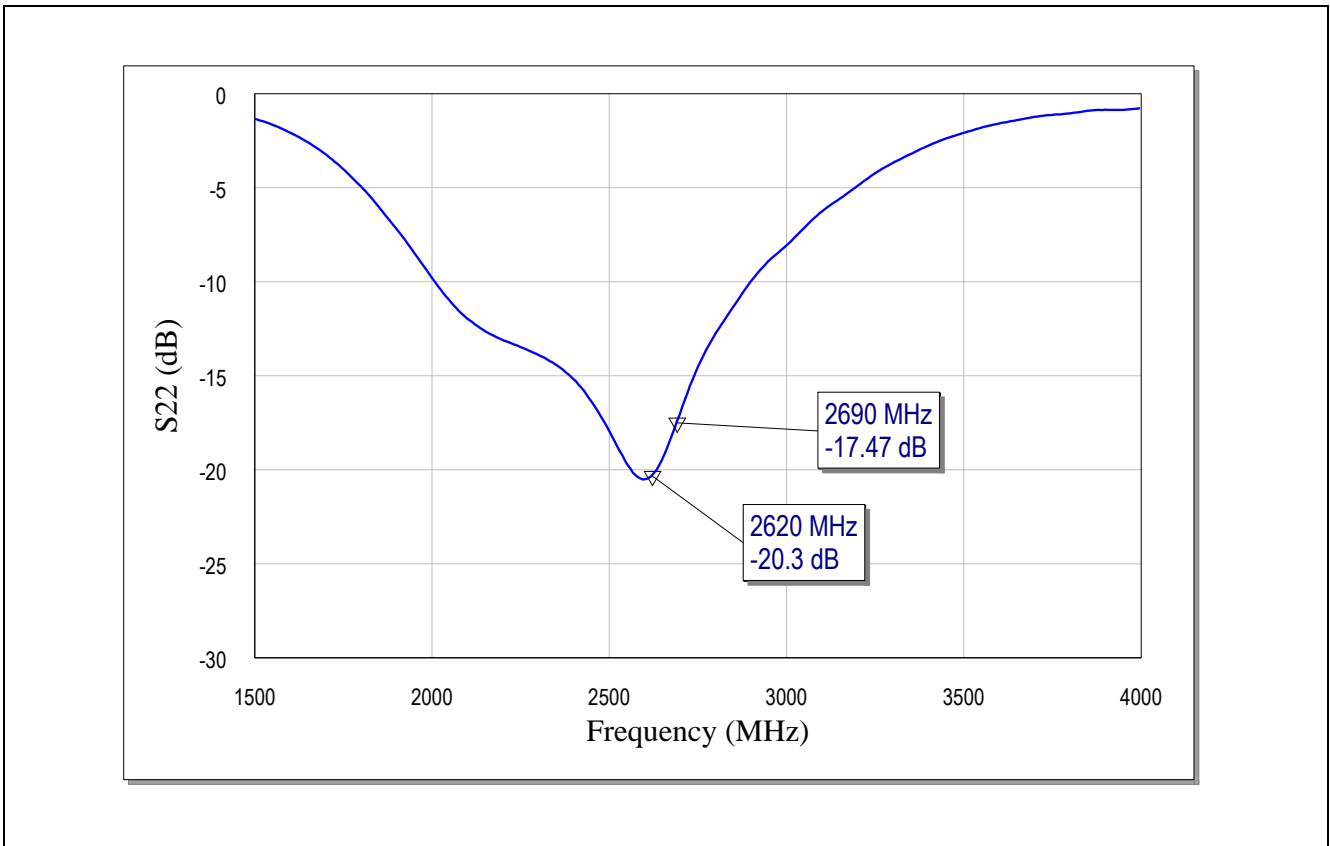

Figure 8 Output Matching of the BFQ790 for Band-7 Applications

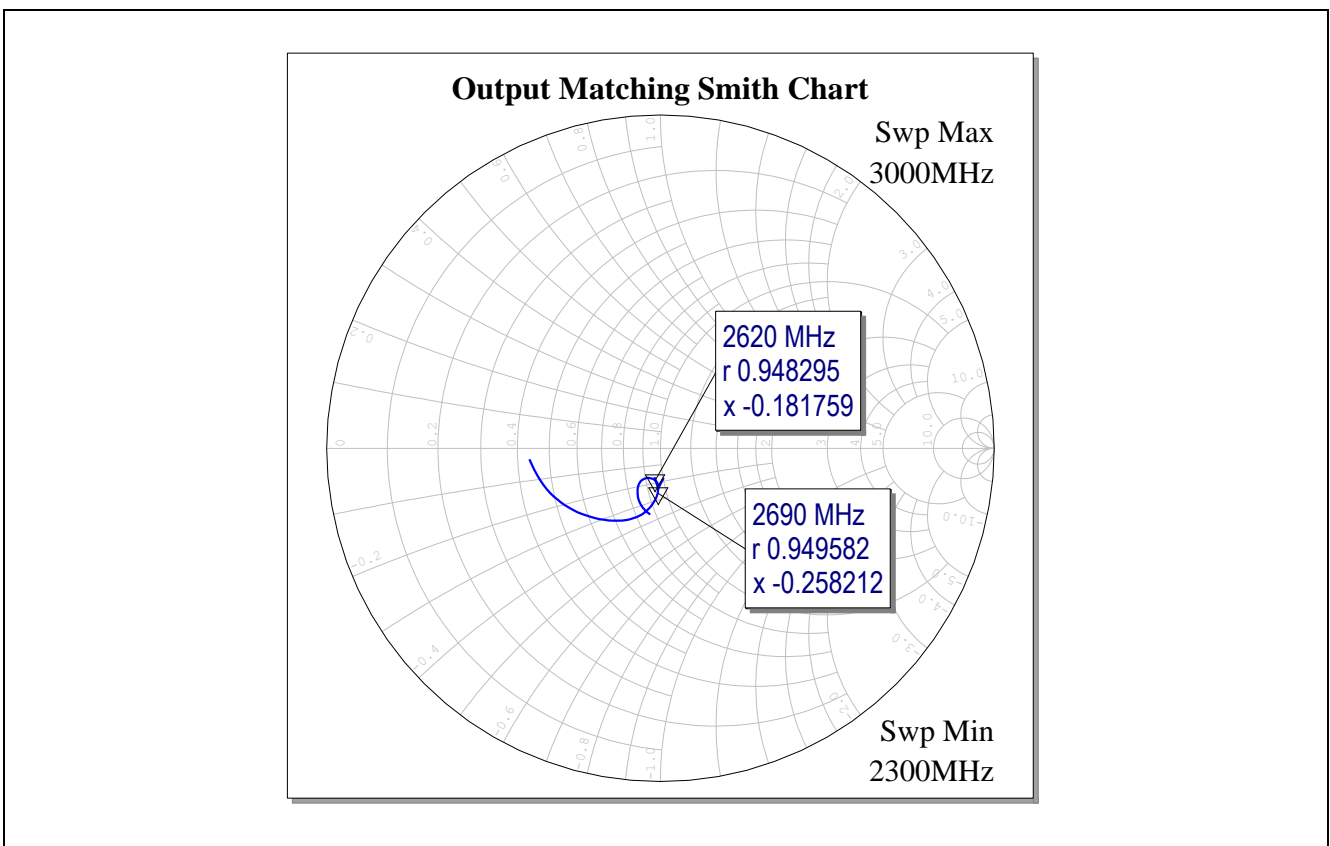

Figure 9 Output Matching (Smith Chart) of the BFQ790 for Band-7 Applications

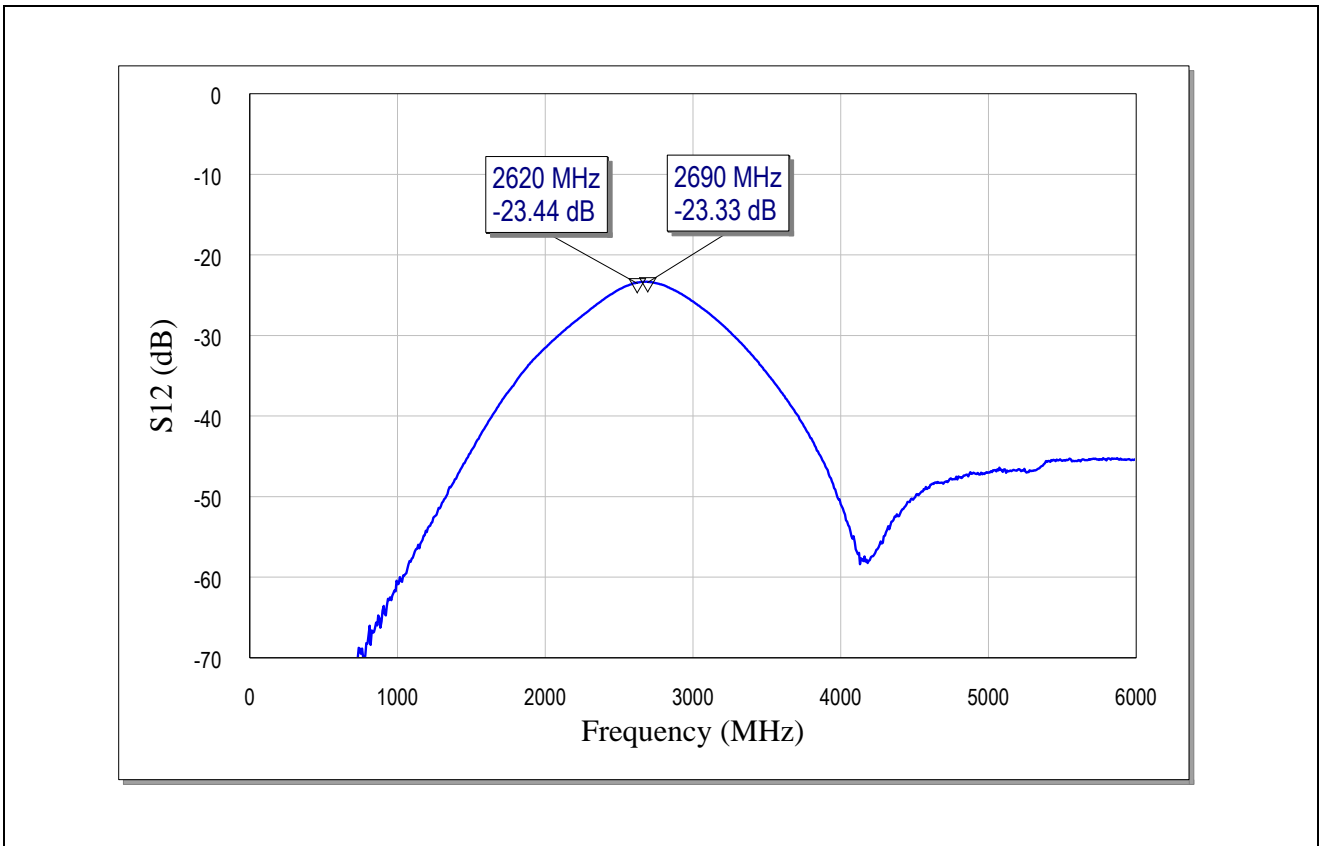

Figure 10 Reverse Isolation of the BFQ790 for Band-7 Applications

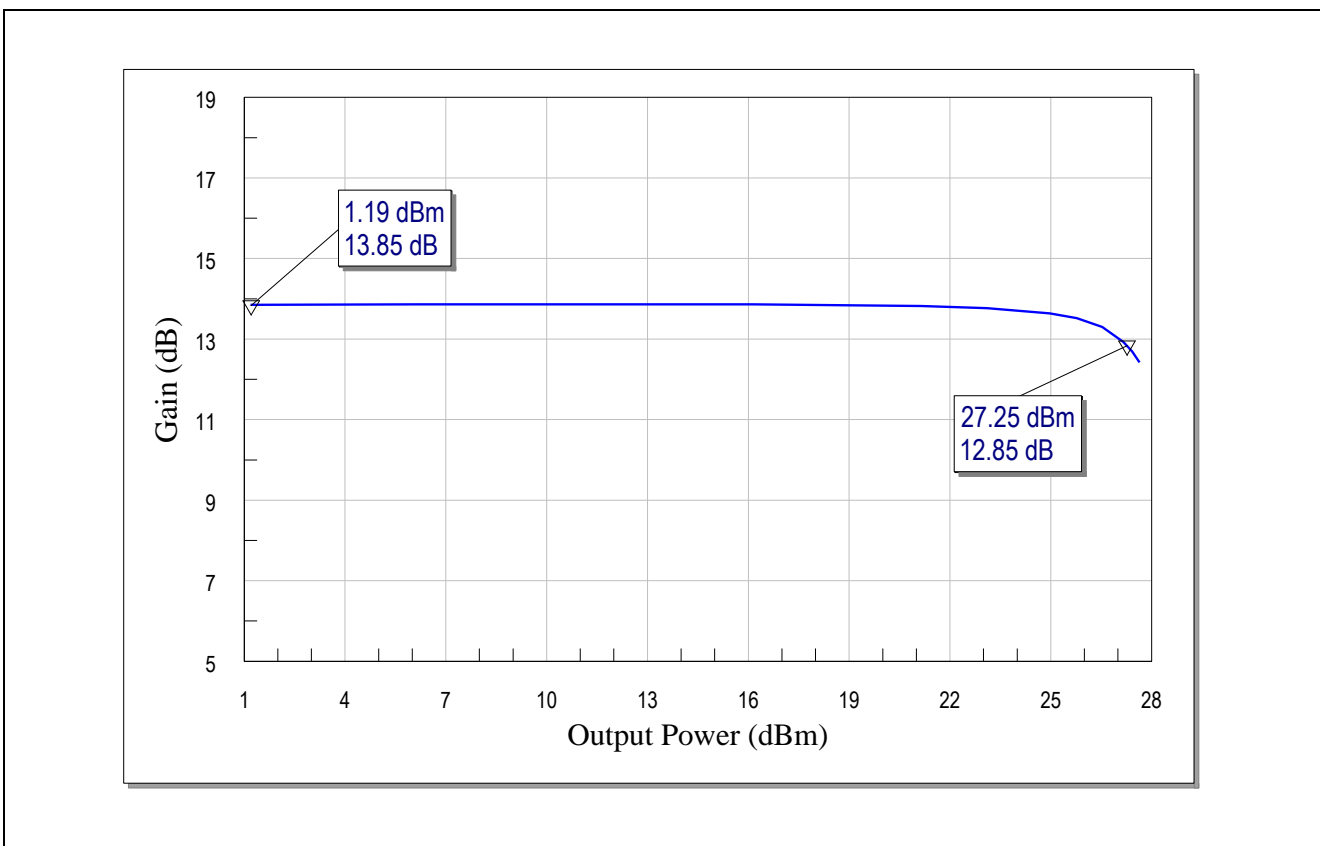

Figure 11 Output 1dB Compression Point of the BFQ790 for Band-7 Applications

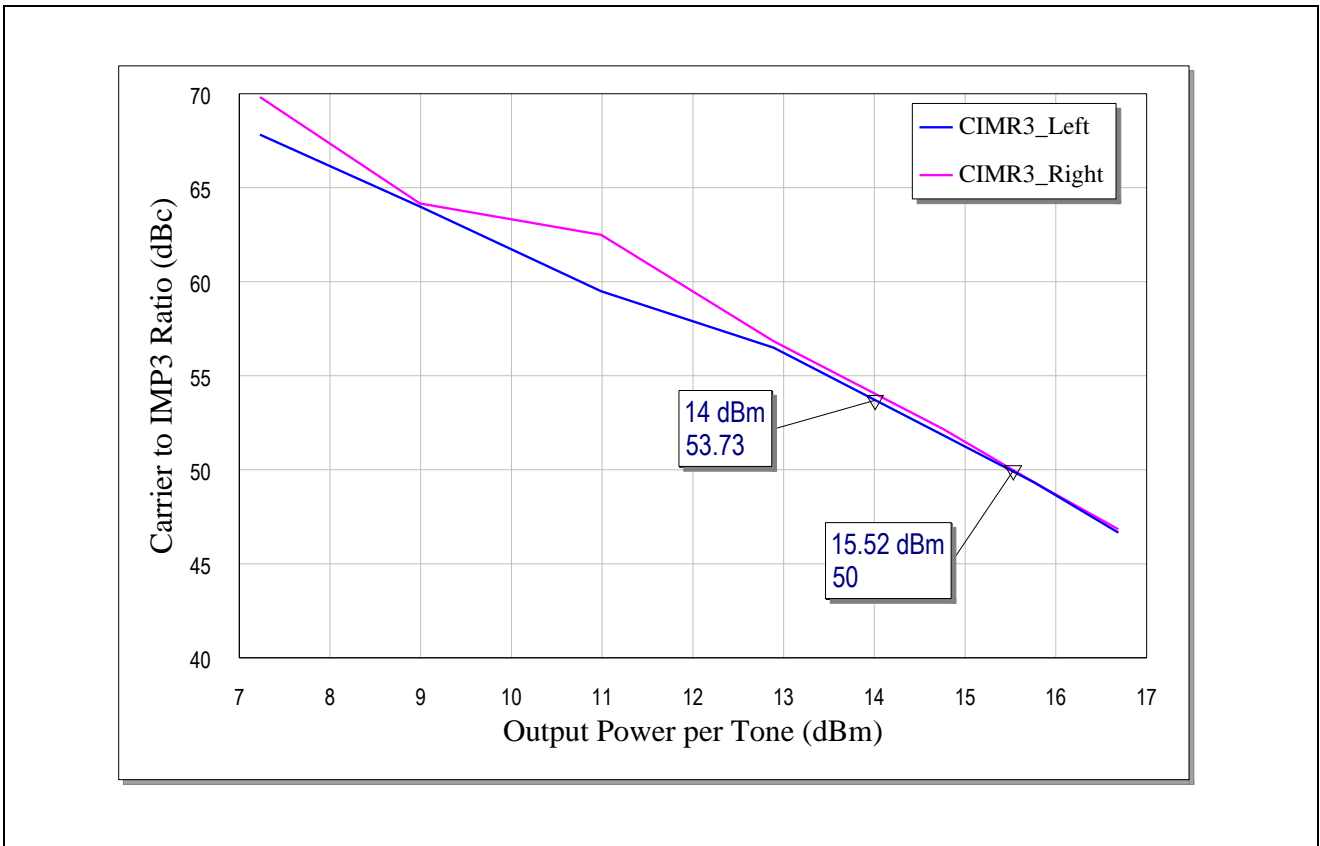

Figure 12 Carrier to IM3 Ratio of the BFQ790 for Band-7 Applications

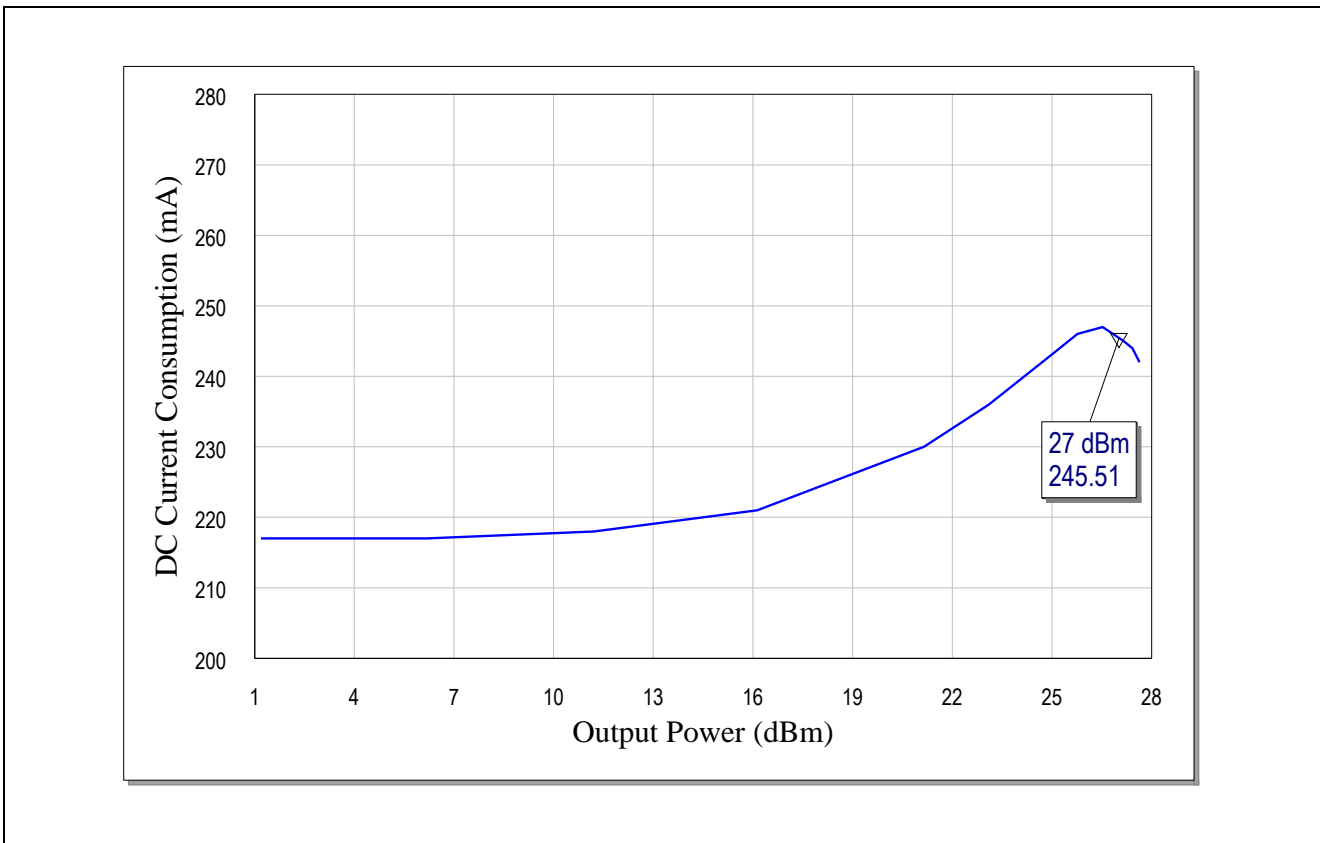

Figure 13 DC Current Consumption versus Output Power of the BFQ790 for Band-7 Applications

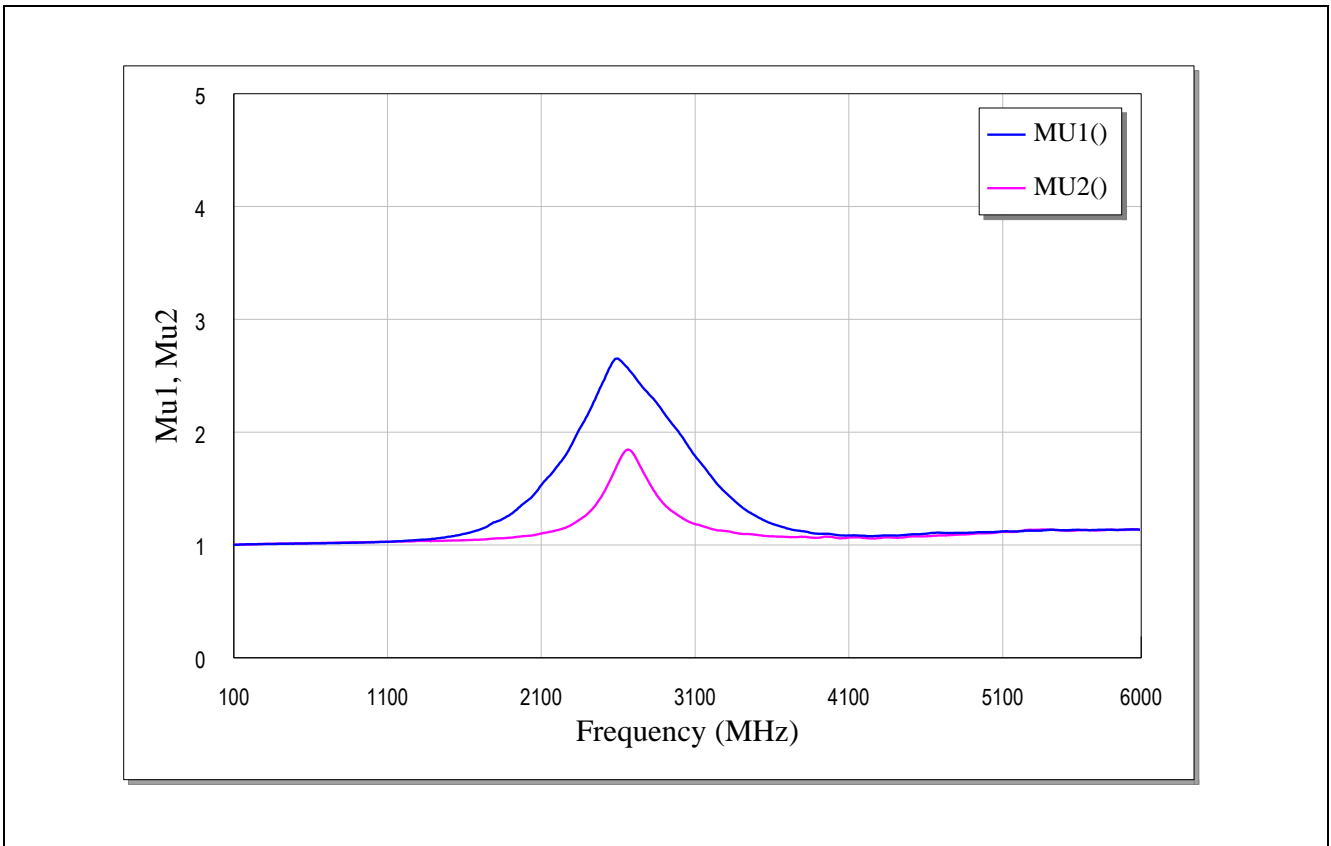

Figure 14 Stability Mu1, Mu2-factors of the BFQ790 for Band-7 Applications

5 Evaluation Board and Layout Information

In this application note, the following PCB is used:

PCB Marking: DRIVER SOT89 V8.0 M130807-89

PCB material: FR4

ϵ_r of PCB material: 4.6

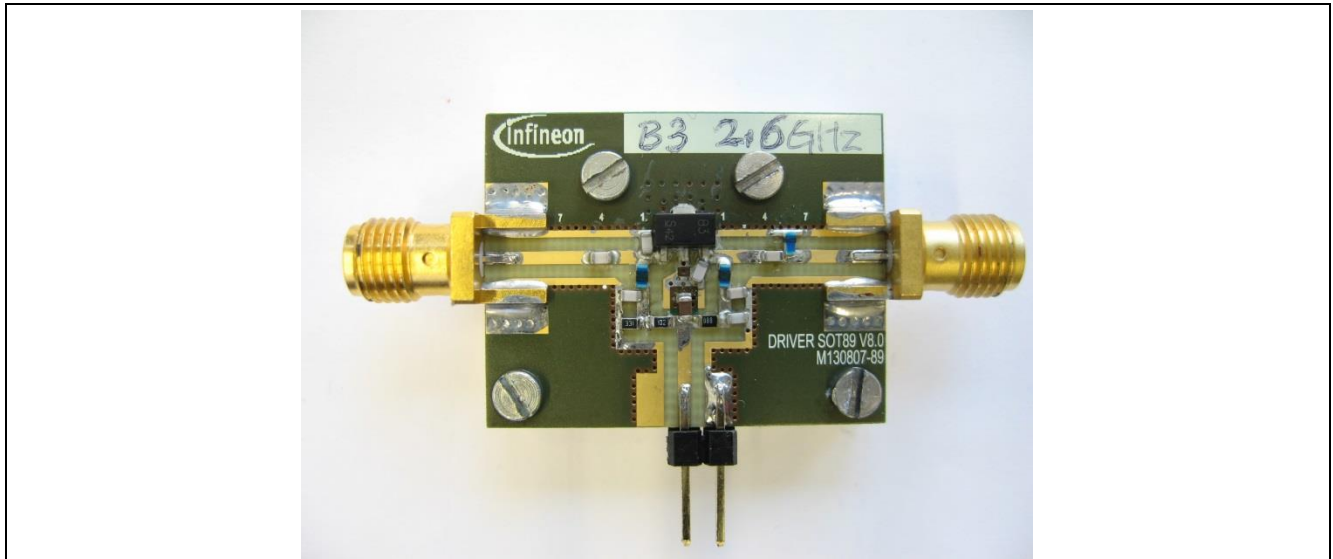

Figure 15 Photo of Evaluation Board of the BFQ790 Application Circuit for LTE Band-7 Application

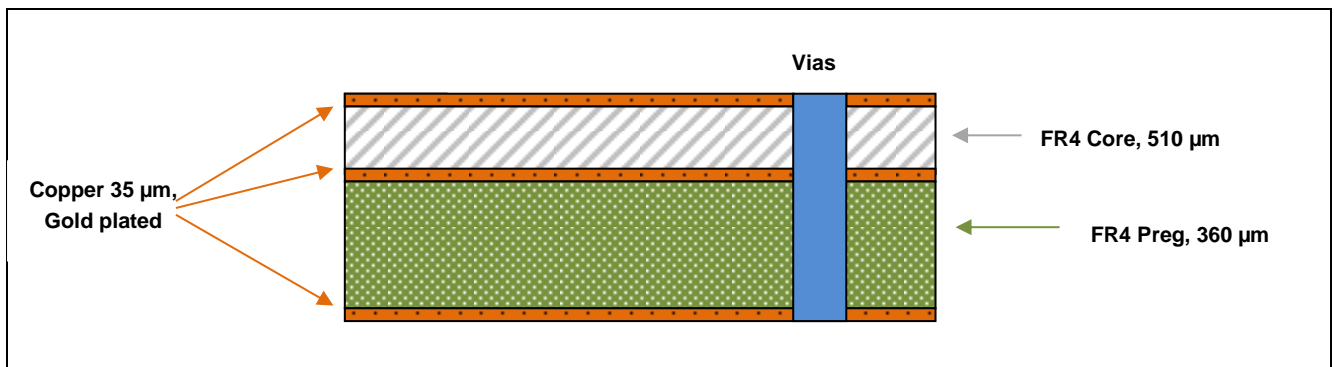

Figure 16 PCB Layer Stack

6 Authors

Dr. Jie Fang, RF Application Engineer of Business Unit “RF and Protection Devices”

Dr. Chih-I Lin, Senior Manager Application Engineering of Business Unit “RF and Protection Devices”

7 Remark

The graphs are generated with the simulation software AWR Microwave Office®.

www.infineon.com